

**RECTIFIER DIODE**

# AR360

Repetitive voltage up to **3200 V**  
 Mean forward current **1075 A**  
 Surge current **10,8 kA**

**FINAL SPECIFICATION**

Dec. 17 - Issue: 5

Symbol	Characteristic	Conditions	T <sub>j</sub> [°C]	Value	Unit
<b>BLOCKING</b>					
V <sub>RRM</sub>	Repetitive peak reverse voltage		160	3200	V
V <sub>RSM</sub>	Non-repetitive peak reverse voltage		160	3300	V
I <sub>RRM</sub>	Repetitive peak reverse current	V=VRRM	160	30	mA
<b>CONDUCTING</b>					
I <sub>F(AV)</sub>	Mean forward current	180° sin, 50 Hz, Th=55°C, double side cooled		1075	A
I <sub>F(AV)</sub>	Mean forward current	180° sin, 50 Hz, Tc=85°C, double side cooled		1089	A
I <sub>FSM</sub>	Surge forward current	Sine wave, 10 ms without reverse voltage	160	10,8	kA
I <sup>2</sup> t	I <sup>2</sup> t			583 x 10 <sup>3</sup>	A <sup>2</sup> s
V <sub>FM</sub>	Forward voltage	Forward current = 3090 A	25	2,13	V
V <sub>F(TO)</sub>	Threshold voltage		160	0,92	V
r <sub>F</sub>	Forward slope resistance		160	0,390	mohm
<b>SWITCHING</b>					
t <sub>rr</sub>	Reverse recovery time	I=100 A	160		μs
Q <sub>rr</sub>	Reverse recovery charge				μC
I <sub>rr</sub>	Peak reverse recovery current				A
<b>MOUNTING</b>					
R <sub>th(j-h)</sub>	Thermal impedance, DC	Junction to heatsink, double side cooled		50,0	°C/kW
R <sub>th(c-h)</sub>	Thermal impedance	Case to heatsink, double side cooled		15,0	°C/kW
T <sub>j</sub>	Operating junction temperature			-30 / 160	°C
F	Mounting force			8.0 / 9.0	kN
	Mass			85	g
<b>ORDERING INFORMATION : AR360 S 32</b> standard specification  VRRM/100					

**DISSIPATION CHARACTERISTICS**

SQUARE WAVE

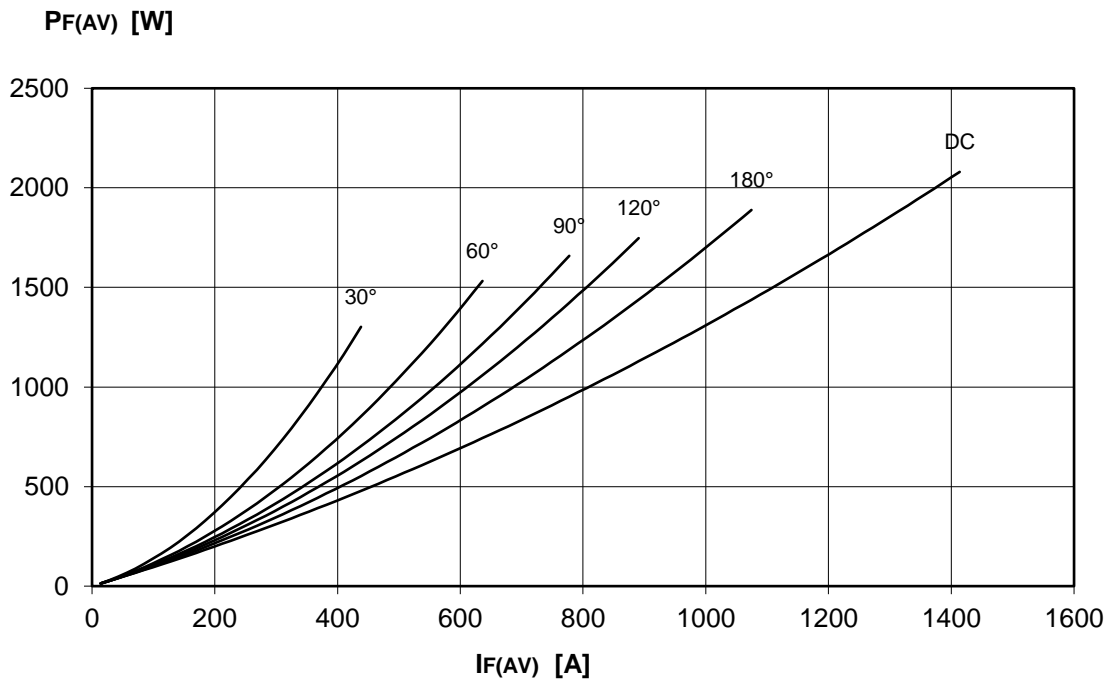
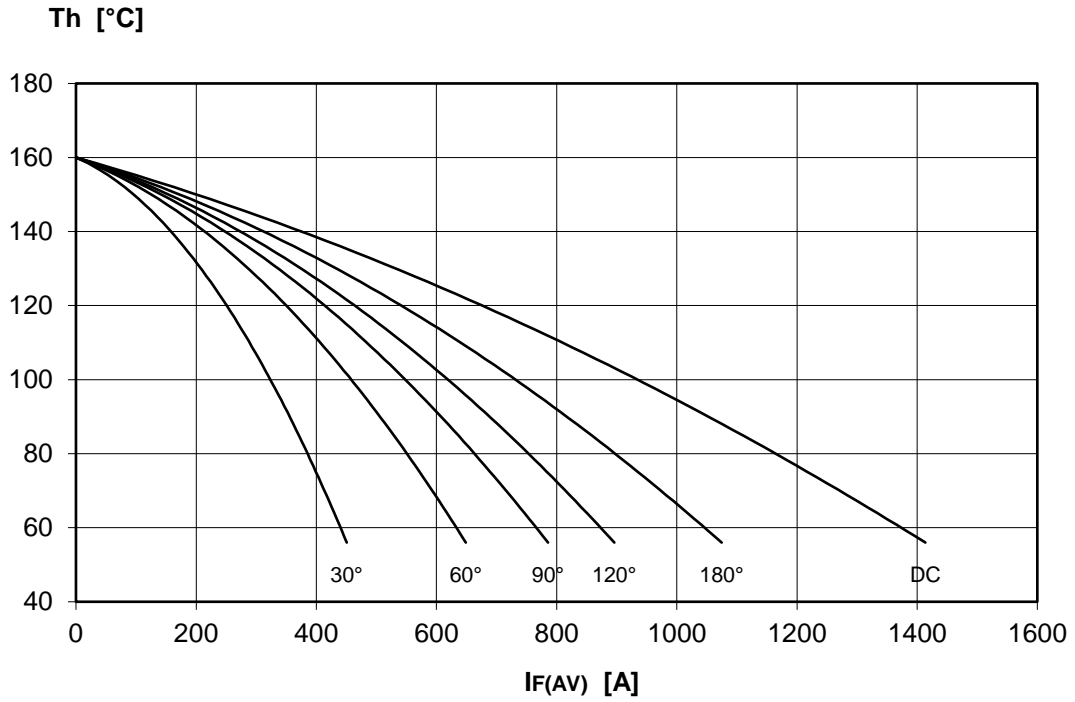

**DISSIPATION CHARACTERISTICS**

SINE WAVE

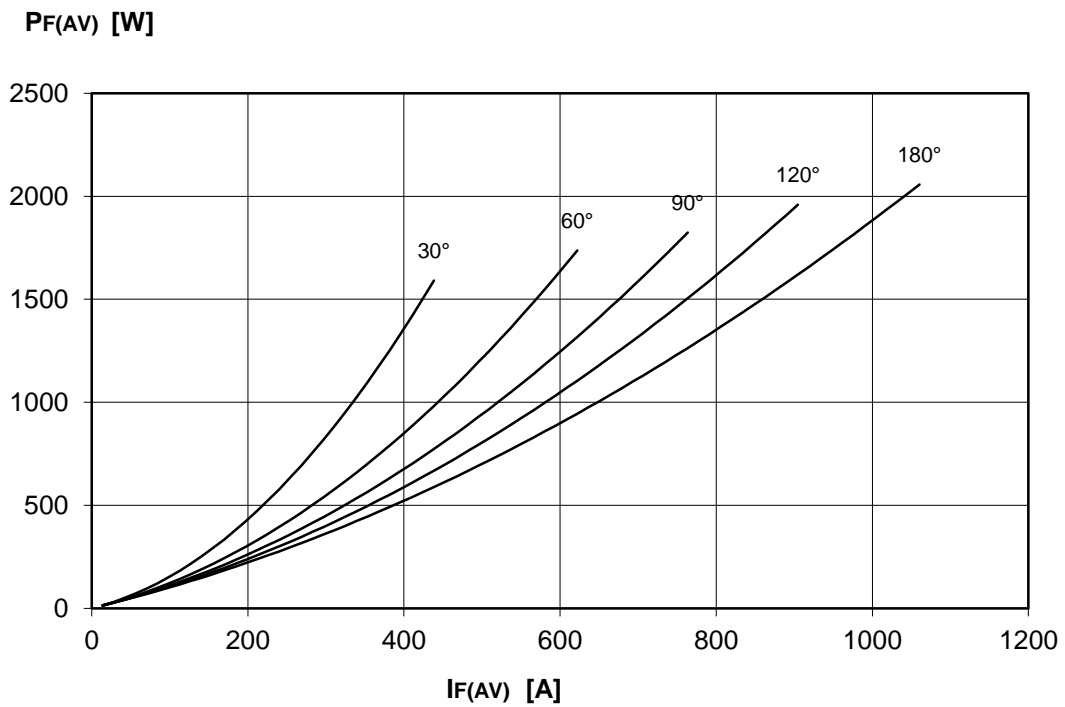
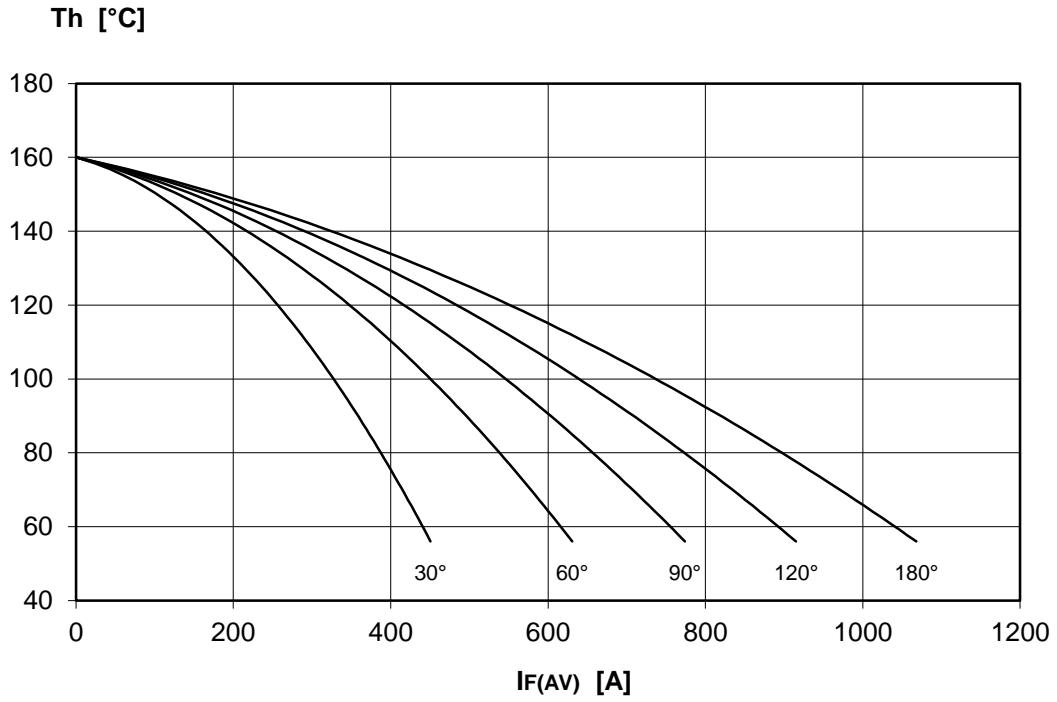

# AR360 RECTIFIER DIODE



FINAL SPECIFICATION Dec. 17 - Issue: 5

FORWARD CHARACTERISTIC  
T<sub>j</sub> = 160 °C

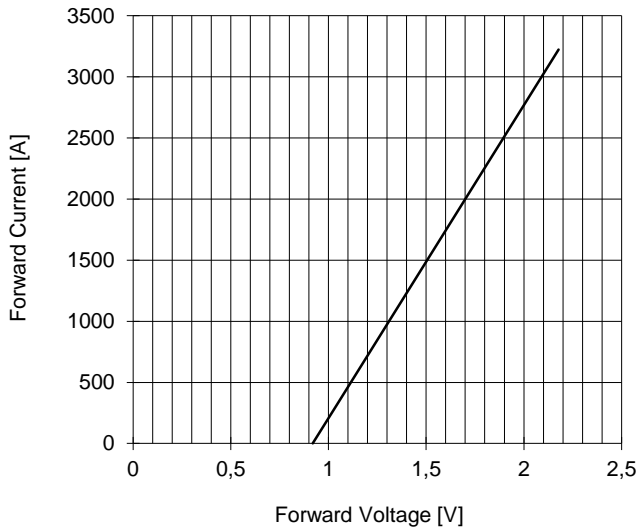

SURGE CHARACTERISTIC  
T<sub>j</sub> = 160 °C

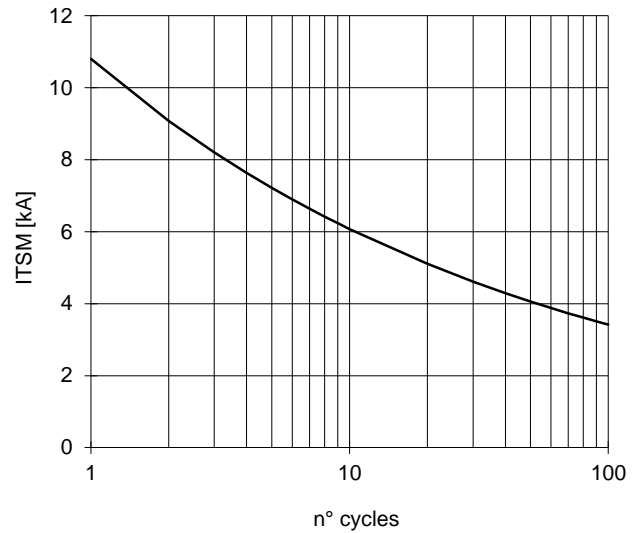

TRANSIENT THERMAL IMPEDANCE  
DOUBLE SIDE COOLED

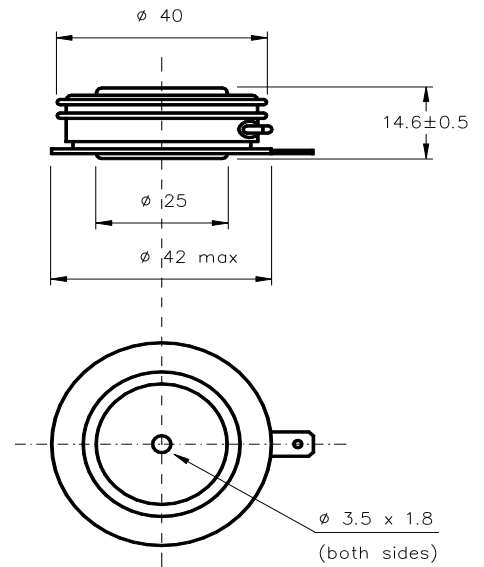
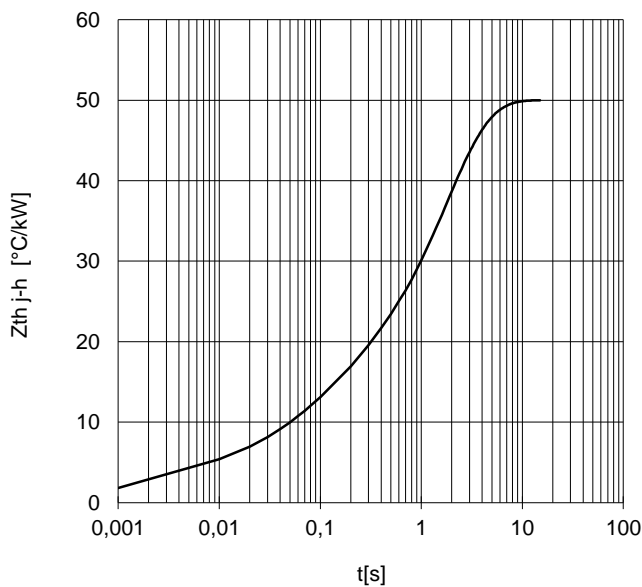

Dimensions  
in mm



All the characteristics given in this data sheet are guaranteed only with uniform clamping force, cleaned and lubricated heatsink, surfaces with flatness < .03 mm and roughness < 2 μm.  
In the interest of product improvement POSEICO SpA reserves the right to change any data given in this data sheet at any time without previous notice.  
If not stated otherwise the maximum value of ratings (symbols over shaded background) and characteristics is reported.

Distributed by

