

## DETAILS

<b>Product Number</b>	FCN13741_GERI-RZ
<b>Family</b>	Geri
<b>Type</b>	Pack
<b>Color</b>	white
<b>Diameter</b>	45 + 45 mm
<b>Height</b>	32,8 mm
<b>Style</b>	square
<b>Optic Material</b>	PMMA
<b>Holder Material</b>	
<b>Fastening</b>	glue, pin, screw
<b>Status</b>	production ready
<b>ROHS Compliant</b>	Yes
<b>Date Updated</b>	31/05/2017



## OPTICAL PROPERTIES

LED	Viewing	Light	Efficiency	cd/lm	Connector
	Angle	Beam			
MC-E RGB	15 deg	Spot	90 %	7.800	-
XM-L RGB	16 deg	Spot	90 %	7.500	-
XQ-E HI RGBW	17 deg	Spot	85 %	6.510	-
XQ-E HD RGBW	17 deg	Spot	86 %	5.200	-
XP-G3	15 deg	Spot	85 %	7.200	-
XT-E	15 deg	Spot	84 %	6.600	-
LUXEON Z RGB	15 deg	Spot	89 %	7.600	-
LUXEON C RGBW	20 deg	Spot	89 %	5.060	-
Ostar-SMT RGB	13 deg	Spot	89 %	9.800	-
OSTAR Stage (S2WP)	15 deg	Spot	87 %	8.660	-
F50360 (RGB)	14 deg	Spot	90 %	9.000	-

Relative intensity of FCN13741\_GERI-RZ\_(XQ-E\_HI\_RGBW)

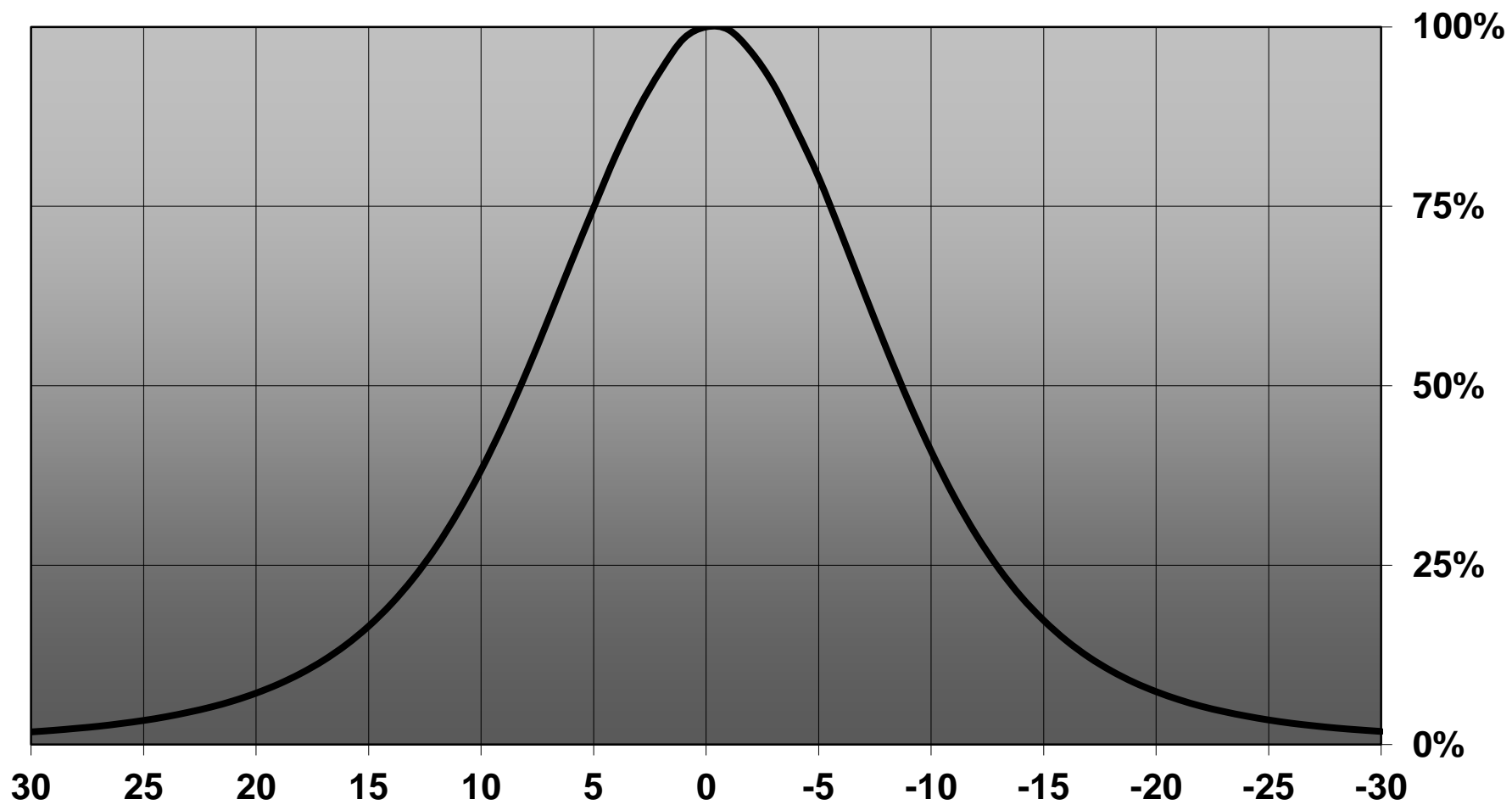

Relative intensity of FCN13741\_GERI-RZ\_(Osram\_Stage\_S2WP)

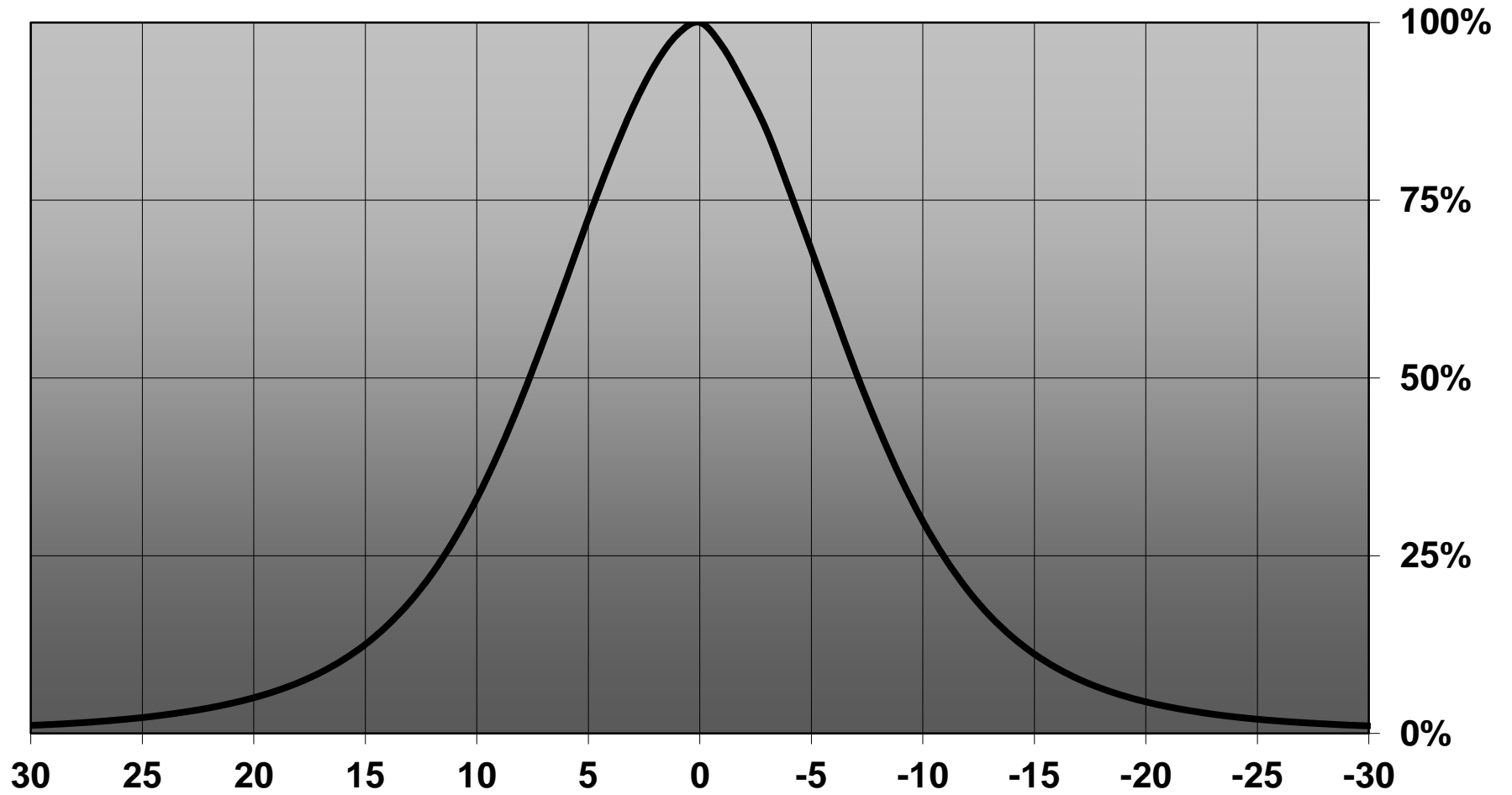

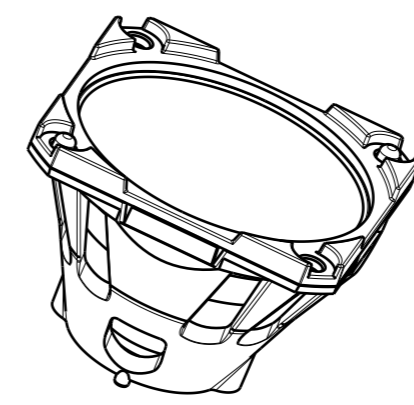
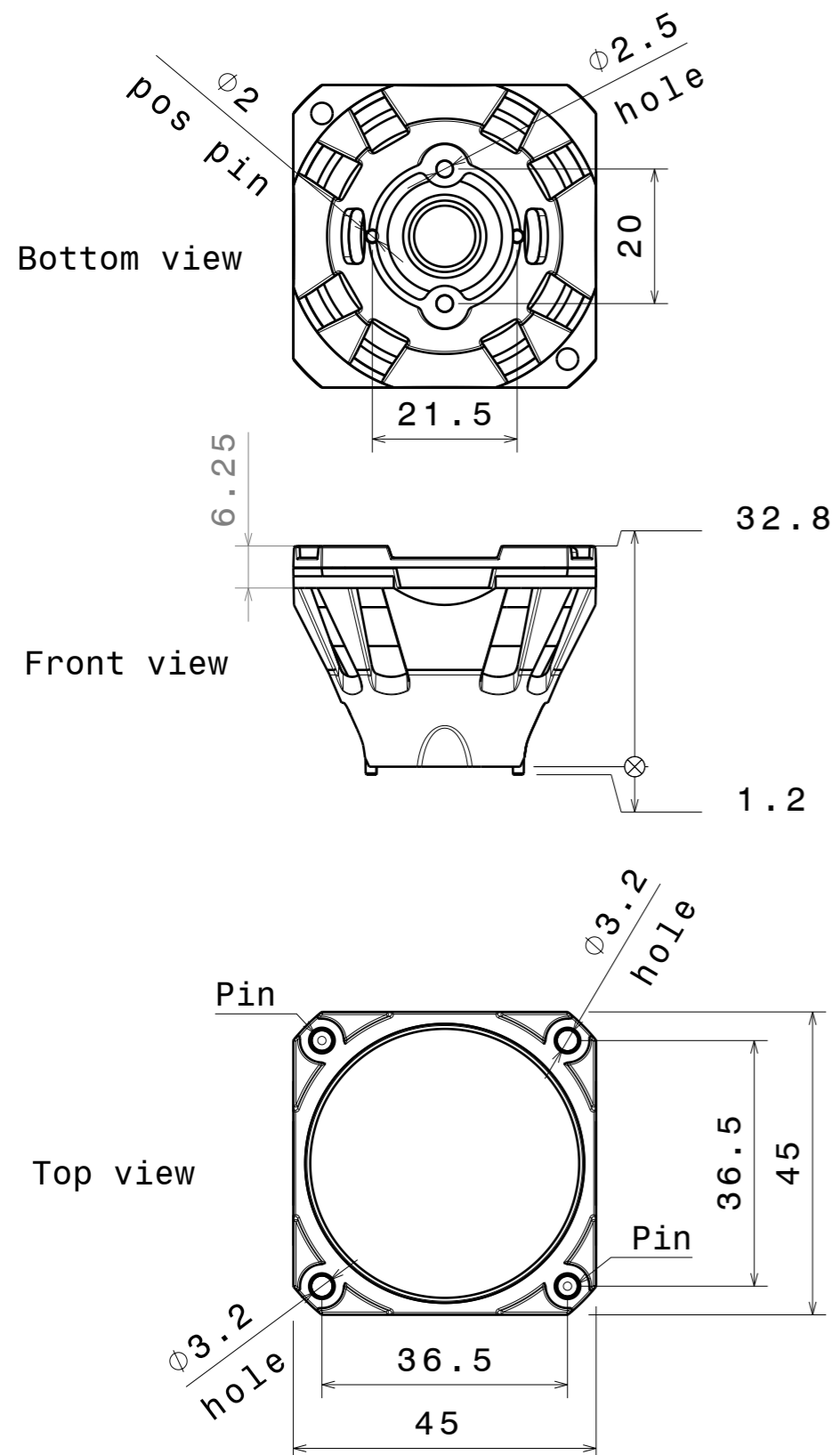

Isometric view

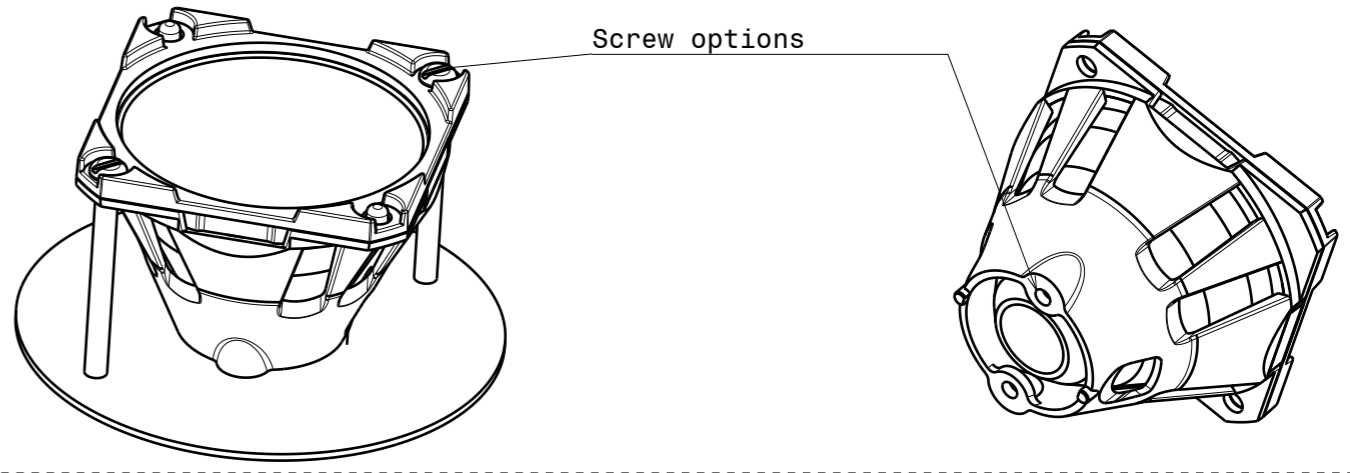
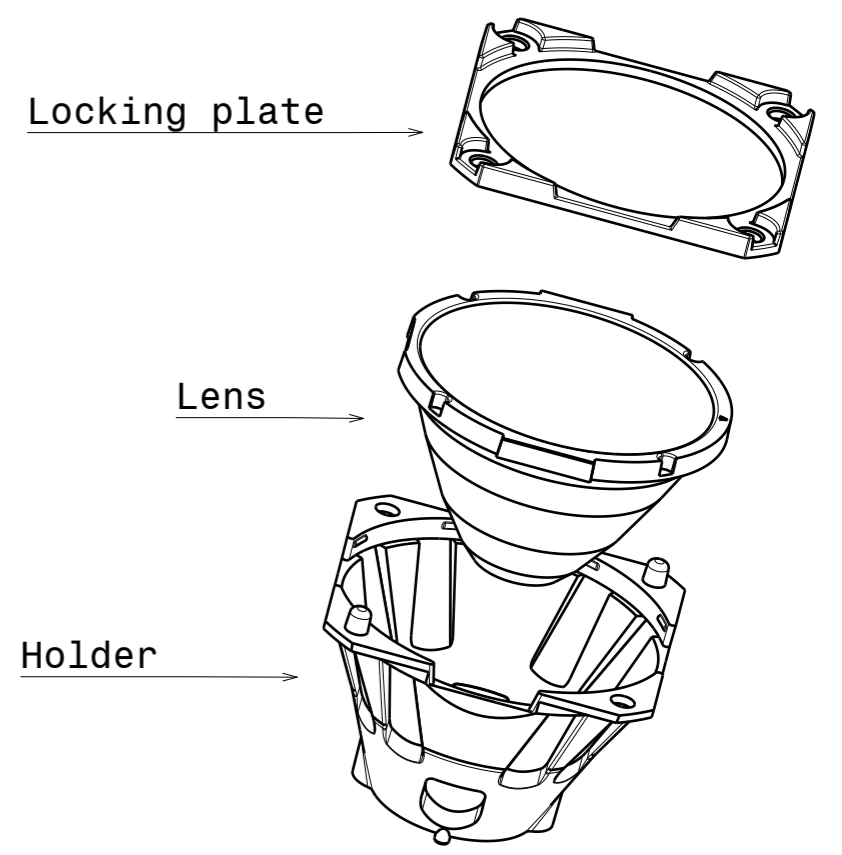

INDEX	PART NO	DESCRIPTION	MATERIAL	COLOUR
1	CN13741	GERI-RZ	Optic PMMA / Holder PC	White

Tolerances if not otherwise shown  
 According to DIN ISO 2768-1  
 Linear measures:  
 Up to 30mm class M, otherwise class C.  
 According to DIN ISO 2768-2  
 Form and position: class L

**LEDiL** Ledil Oy  
 Salorankatu 10  
 FIN 24240 SALO  
 Finland

THIRD ANGLE PROJECTION:

DRAWING TITLE  
**CN13741\_GERI-RZ**

This drawing is the property of LEDiL Oy. It may not be reproduced, copied or communicated without a written agreement with LEDiL Oy."

SIZE **A3** PART NUMBER **CN13741**

SCALE 1:1 WEIGHT SHEET 1/1

# Ledil CN13741\_GERI-RZ\_(MC-E\_RGBW) / LDC (Linear)

Luminaire: Ledil CN13741\_GERI-RZ\_(MC-E\_RGBW)

Lamps: 1 x CREE\_MC-E\_RGBW\_170.896lm@250mA\_P=2.8W\_I=0.25A

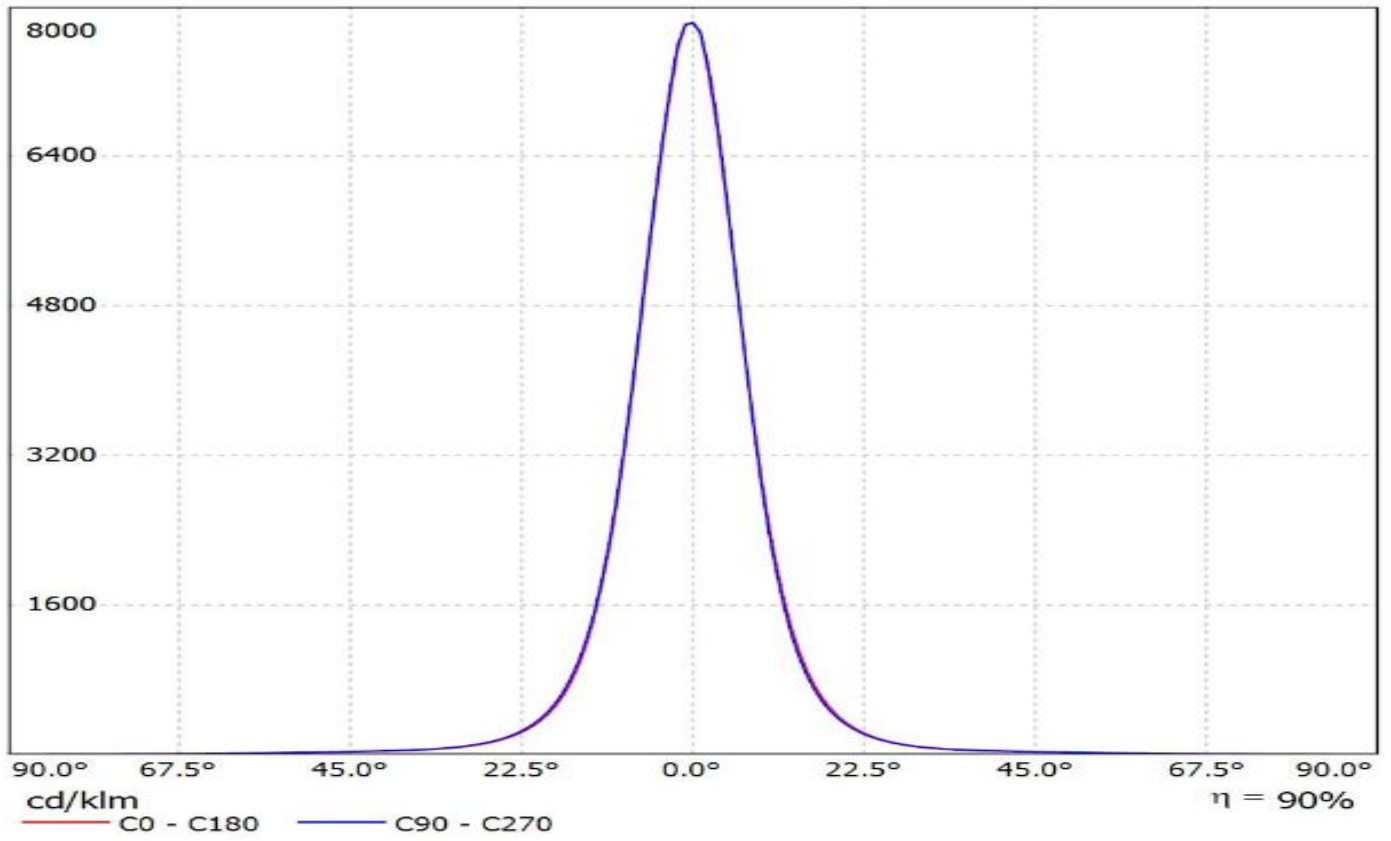

# Ledil CN13741\_GERI-RZ\_(XM-L\_RGBW) / LDC (Linear)

Luminaire: Ledil CN13741\_GERI-RZ\_(XM-L\_RGBW)  
Lamps: 1 x CREE\_XM-L\_RGBW\_(XMLCTW-A0-0000-00C3AAAA1)  
\_215.885lm@250mA\_P=2.7W\_I=0.25A

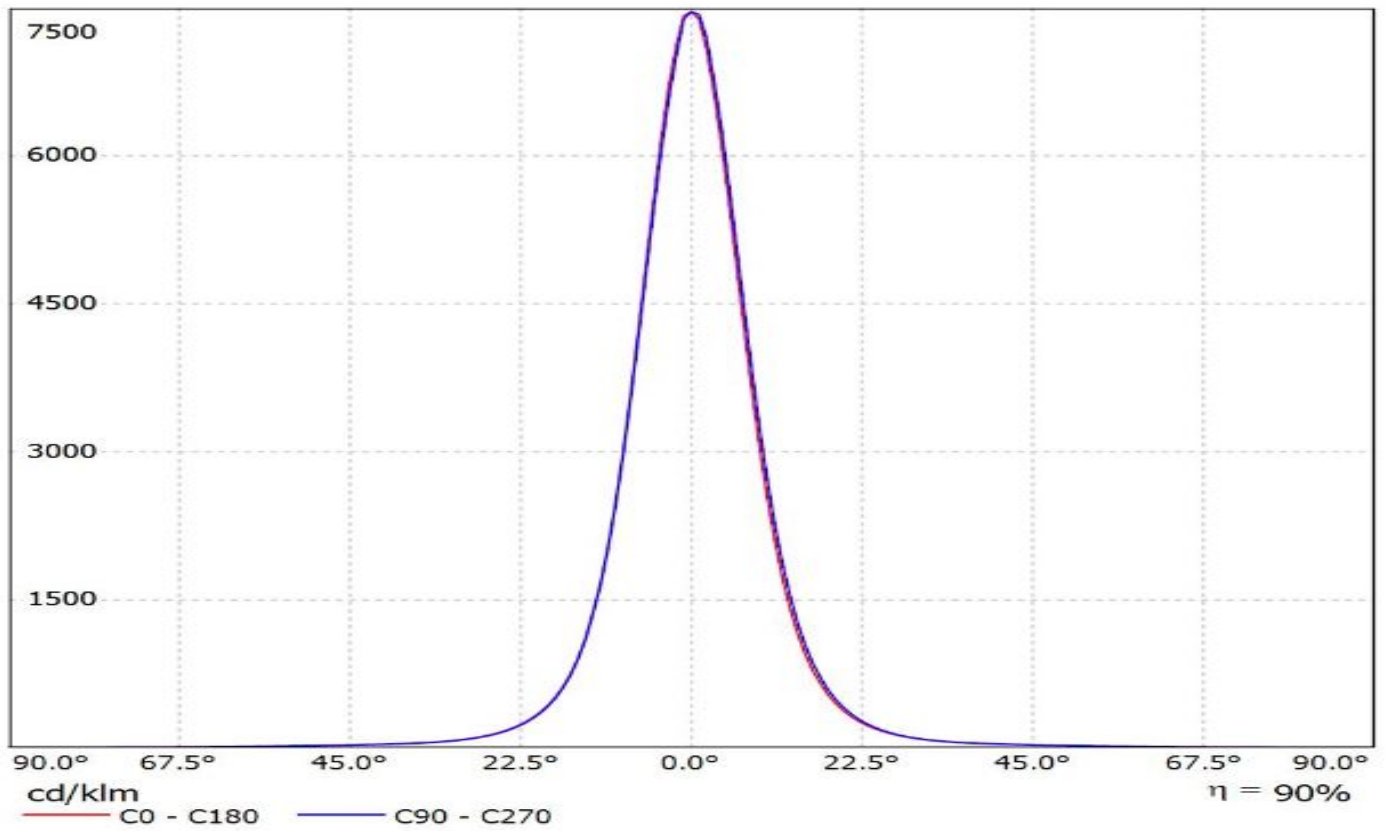

Luminaire: Ledil FCN13741\_GERI-RZ\_(XQE\_HI\_RGBW)

Lamps: 1 x Cree\_XQE\_HI\_RGBW\_212.518lm@250mA\_P=2.7397W\_I=0.250A

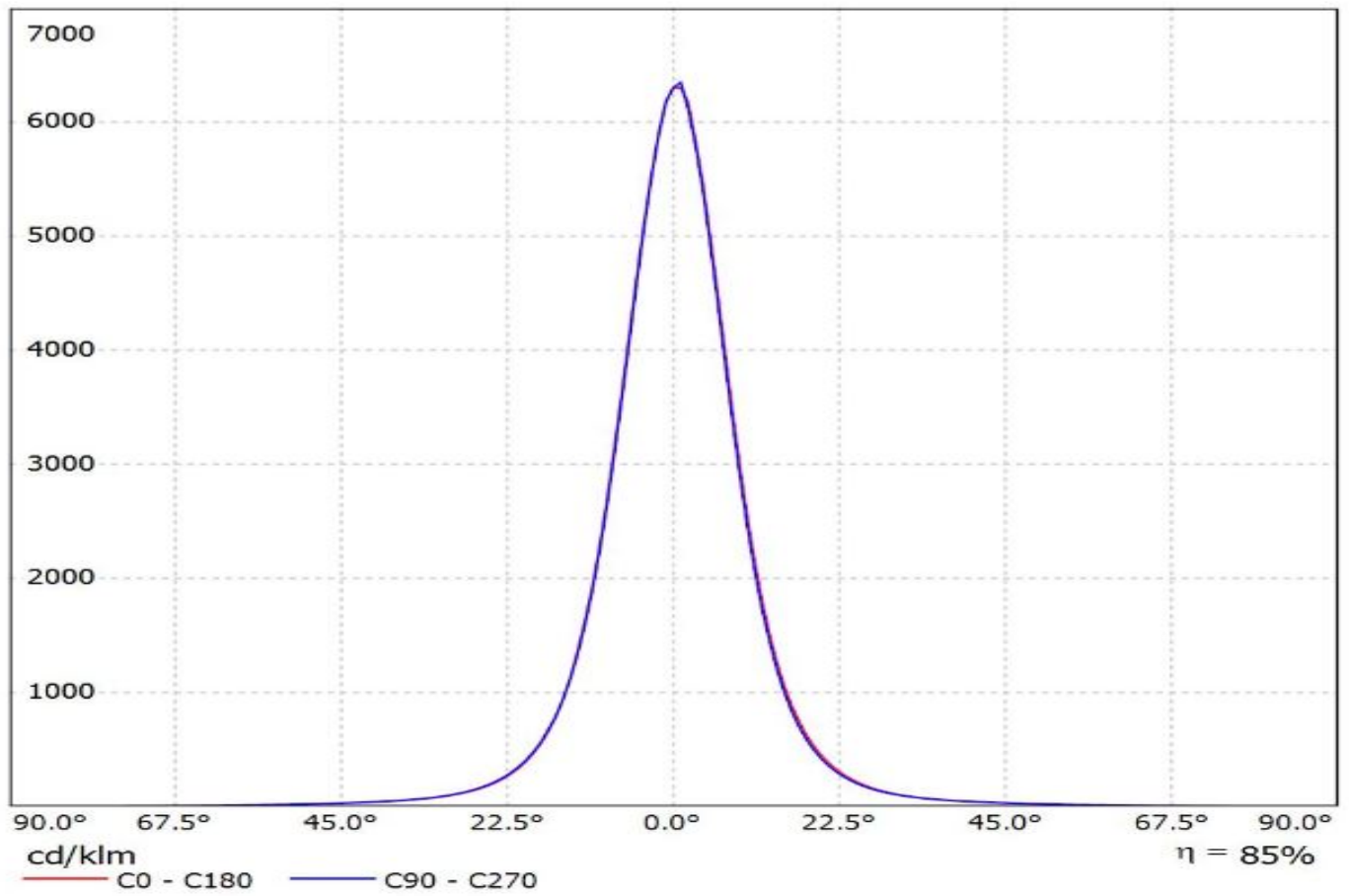

Luminaire: Ledil FCN13741\_GERI-RZ (XQ-E\_HD\_RGBW)

Lamps: 1 x Cree\_XQ-E\_HD\_RGBW\_233.24lm@250mA\_P=2.7265W\_I=0.250A

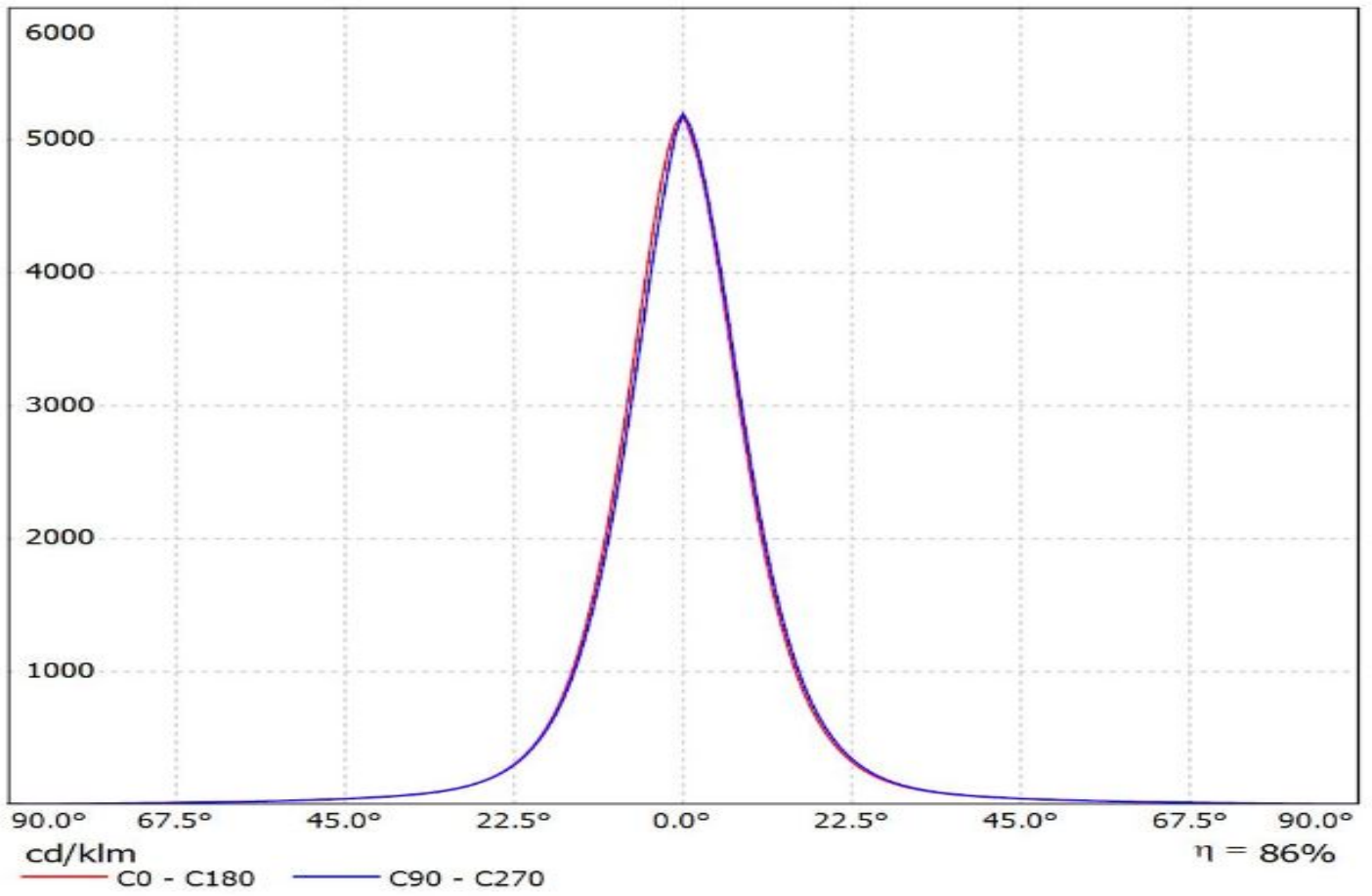



Luminaire: Ledil FCN13741\_GERI-RZ\_(XP-G3)  
Lamps: 1 x Cree\_XP-G3\_109.458lm@250mA\_P=0.738275W\_I=0.250A

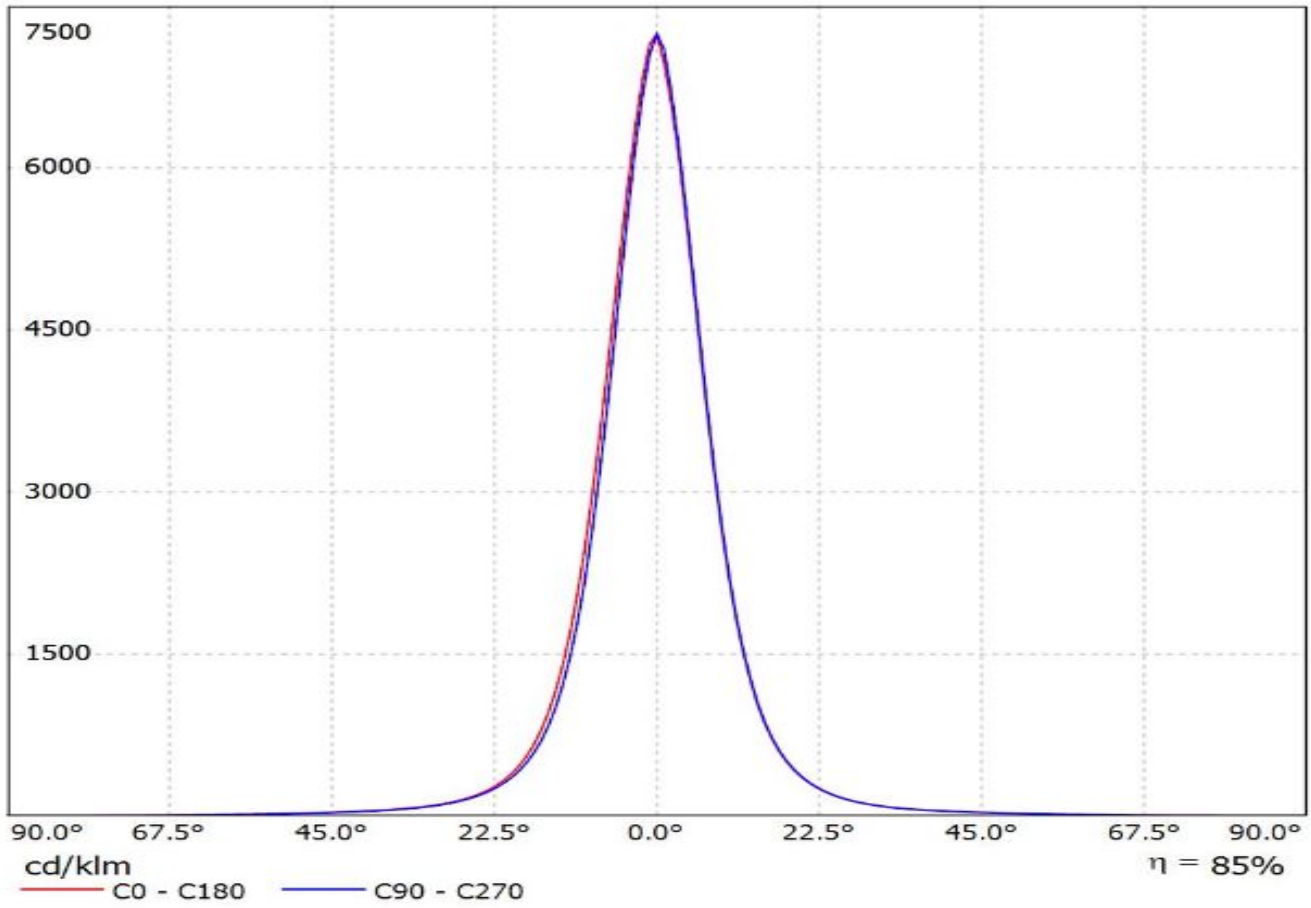

Luminaire: Ledil FCN13741\_GERI-RZ\_(XT-E)

Lamps: 1 x Cree\_XT-E\_(XT-EAWT-0-2A0-R30-FB-0001)\_100.346lm@250mA\_P=0.795125W\_I=0.250A

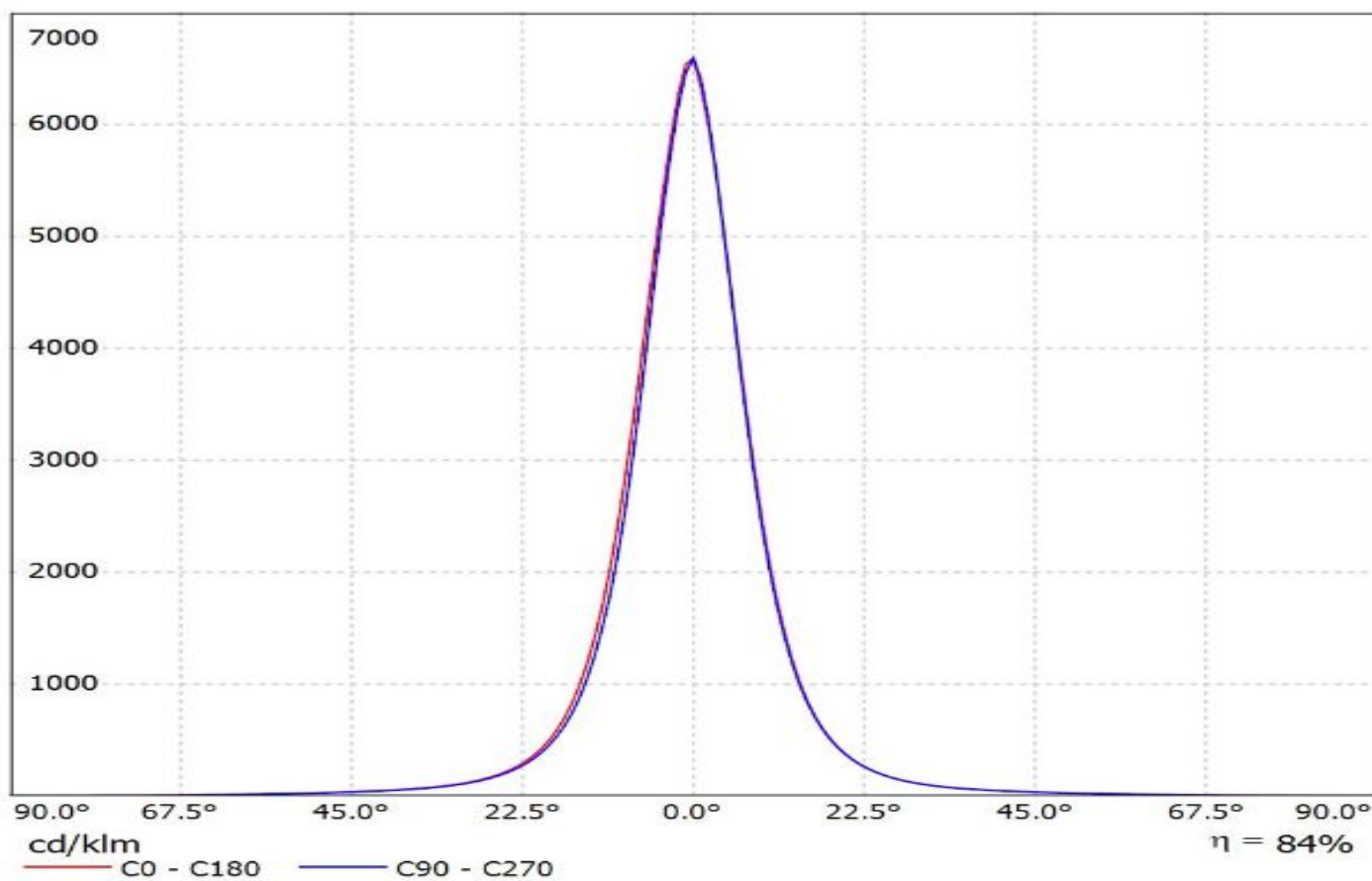

# Ledil CN13741\_GERI-RZ\_(LUXEON\_Z\_RGBW) / LDC (Linear)

Luminaire: Ledil CN13741\_GERI-RZ\_(LUXEON\_Z\_RGBW)

Lamps: 1 x LUXEON\_Z\_RGBW\_165.276lm@250mA\_P=2.6W\_I=0.25A

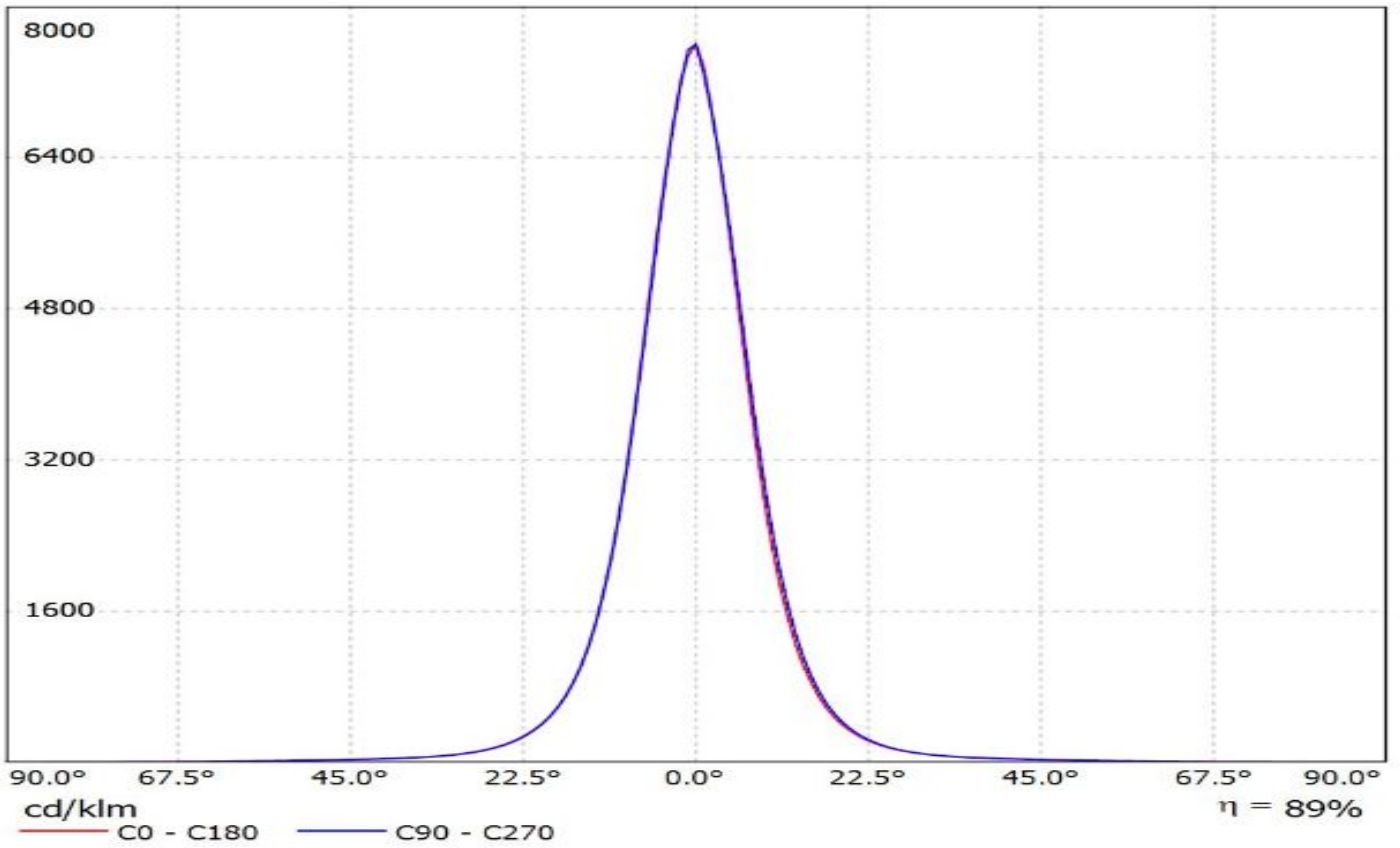

Luminaire: LEDiL Oy FCN13741\_GERI-RZ\_(Luxeon\_C\_RGBW)  
Lamps: 1 x Luxeon\_C\_RGBW\_208.984lm@250mA\_P=2.5474W\_I=0.250A

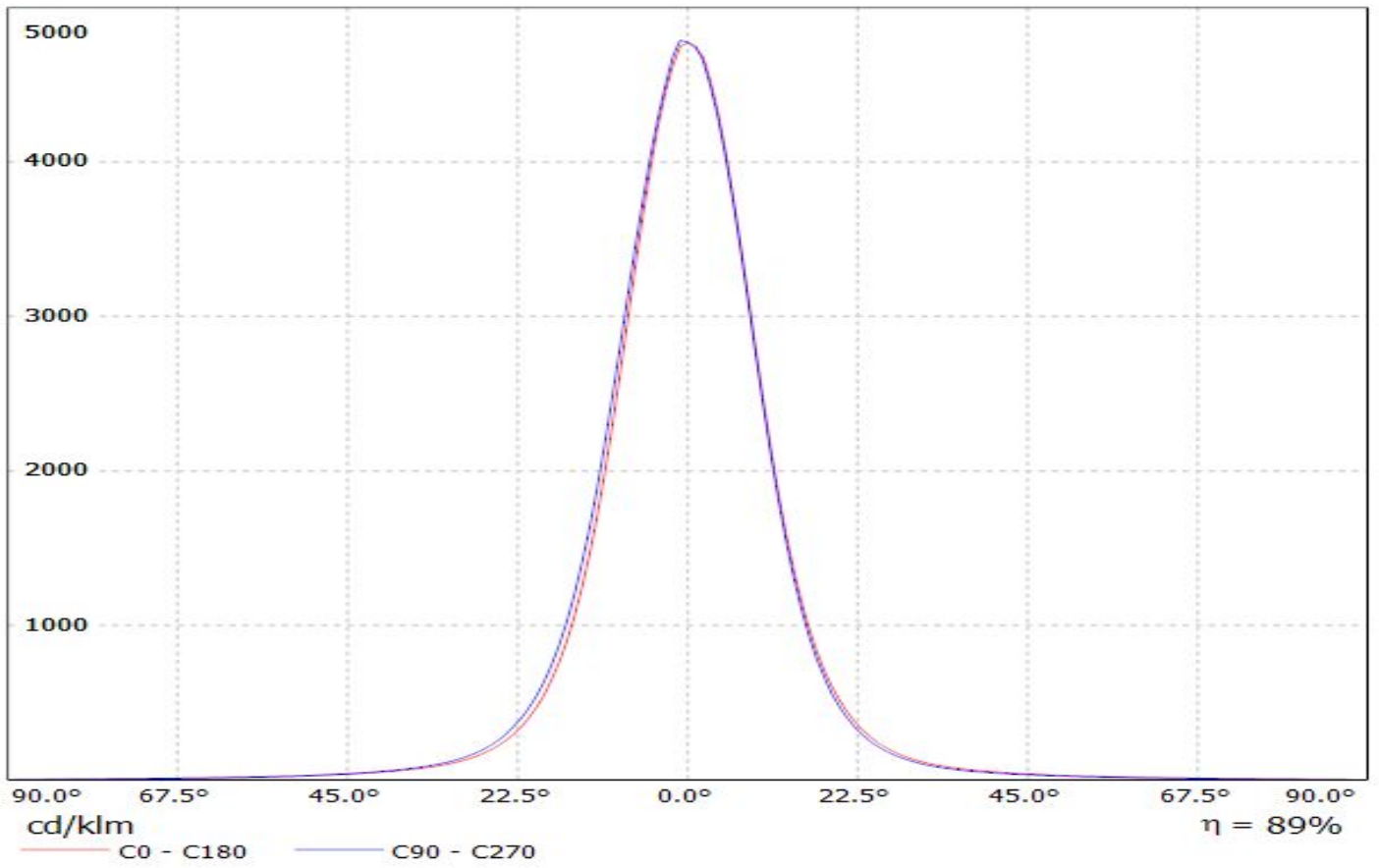

# Ledil CN13741\_GERI-RZ\_(OSTAR-SMT\_RGB) / LDC (Linear)

Luminaire: Ledil CN13741\_GERI-RZ\_(OSTAR-SMT\_RGB)

Lamps: 1 x OSRAM\_OSTAR-SMT\_RGB\_168.879lm@250mA\_P=3W\_I=0.25A

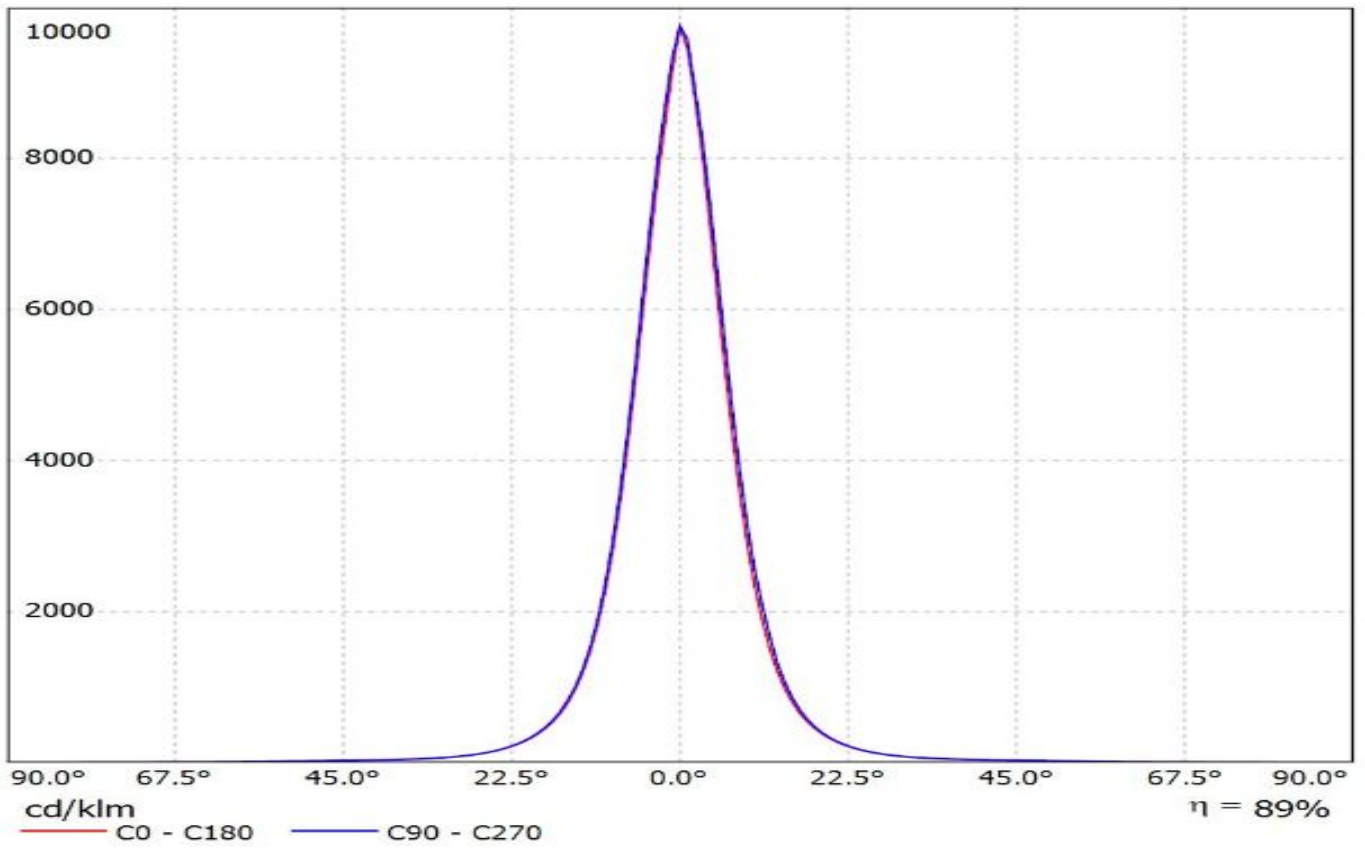

# Ledil CN13741\_GERI-RZ\_(F50360\_RGB) / LDC (Linear)

Luminaire: Ledil CN13741\_GERI-RZ\_(F50360\_RGB)

Lamps: 1 x SEOUL\_F50360\_RGB\_(-01\_QLSRBH)\_57.1364lm@250mA\_P=2.1W\_I=0.25A

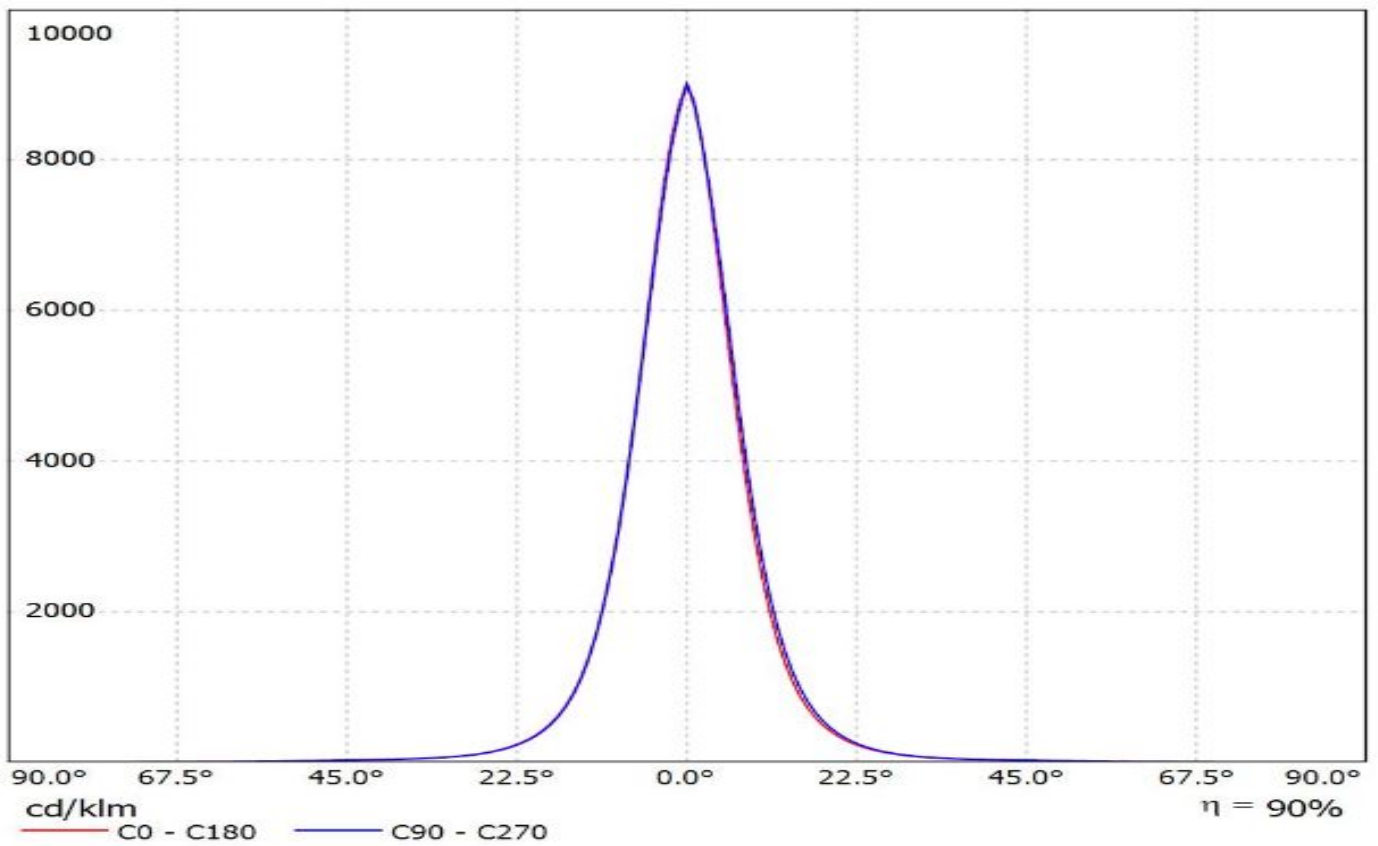

# Ledil CN13741\_GERI-RZ\_(MC-E\_RGBW) / LDC (Polar)

Luminaire: Ledil CN13741\_GERI-RZ\_(MC-E\_RGBW)

Lamps: 1 x CREE\_MC-E\_RGBW\_170.896lm@250mA\_P=2.8W\_I=0.25A

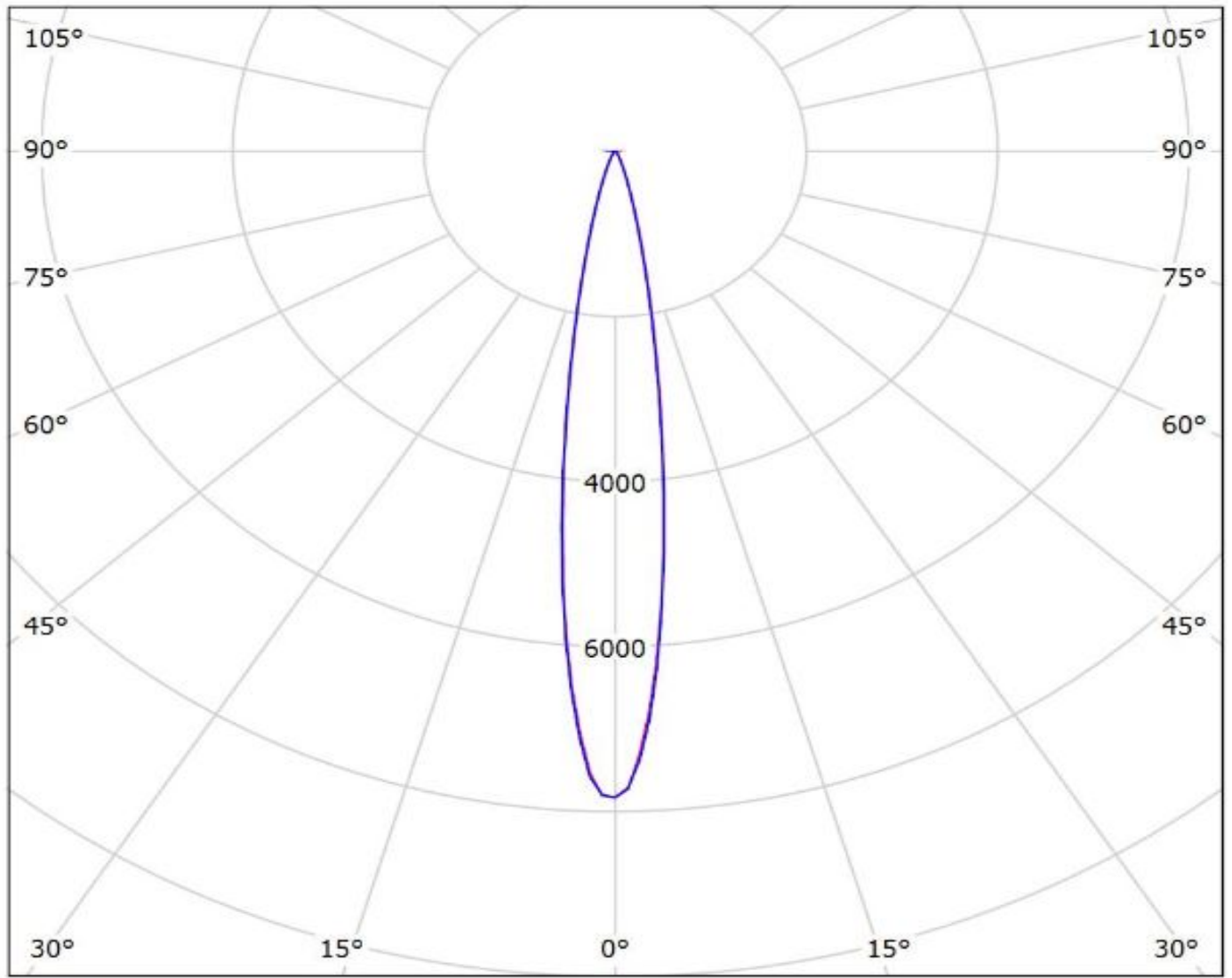

cd/klm

— C0 - C180

— C90 - C270

$\eta = 90\%$

# Ledil CN13741\_GERI-RZ\_(XM-L\_RGBW) / LDC (Polar)

Luminaire: Ledil CN13741\_GERI-RZ\_(XM-L\_RGBW)

Lamps: 1 x CREE\_XM-L\_RGBW\_(XMLCTW-A0-0000-00C3AAAA1)

\_215.885lm@250mA\_P=2.7W\_I=0.25A

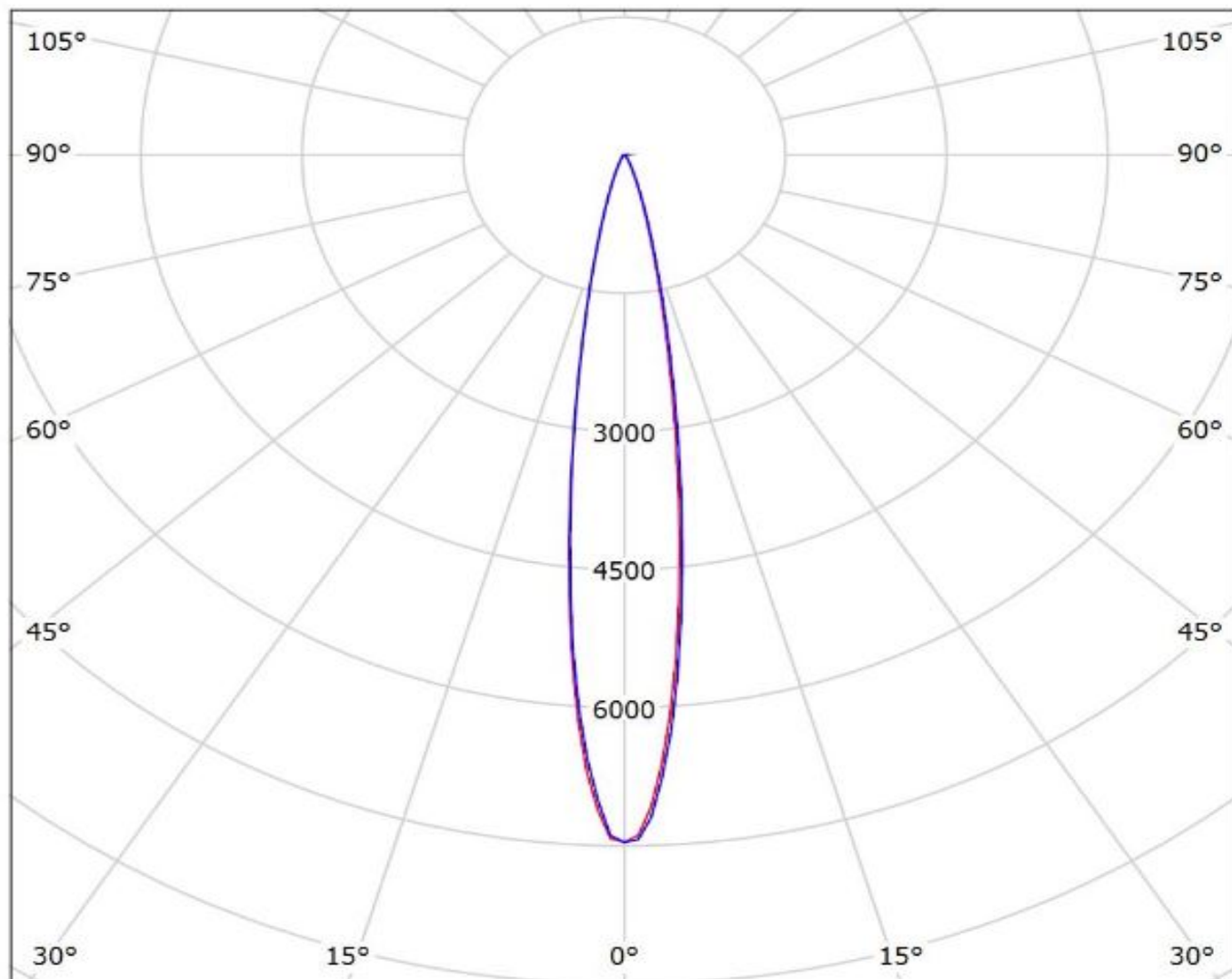

cd/klm

— C0 - C180

— C90 - C270

$\eta = 90\%$



Luminaire: Ledil FCN13741\_GERI-RZ\_(XQE\_HI\_RGBW)

Lamps: 1 x Cree\_XQE\_HI\_RGBW\_212.518lm@250mA\_P=2.7397W\_I=0.250A

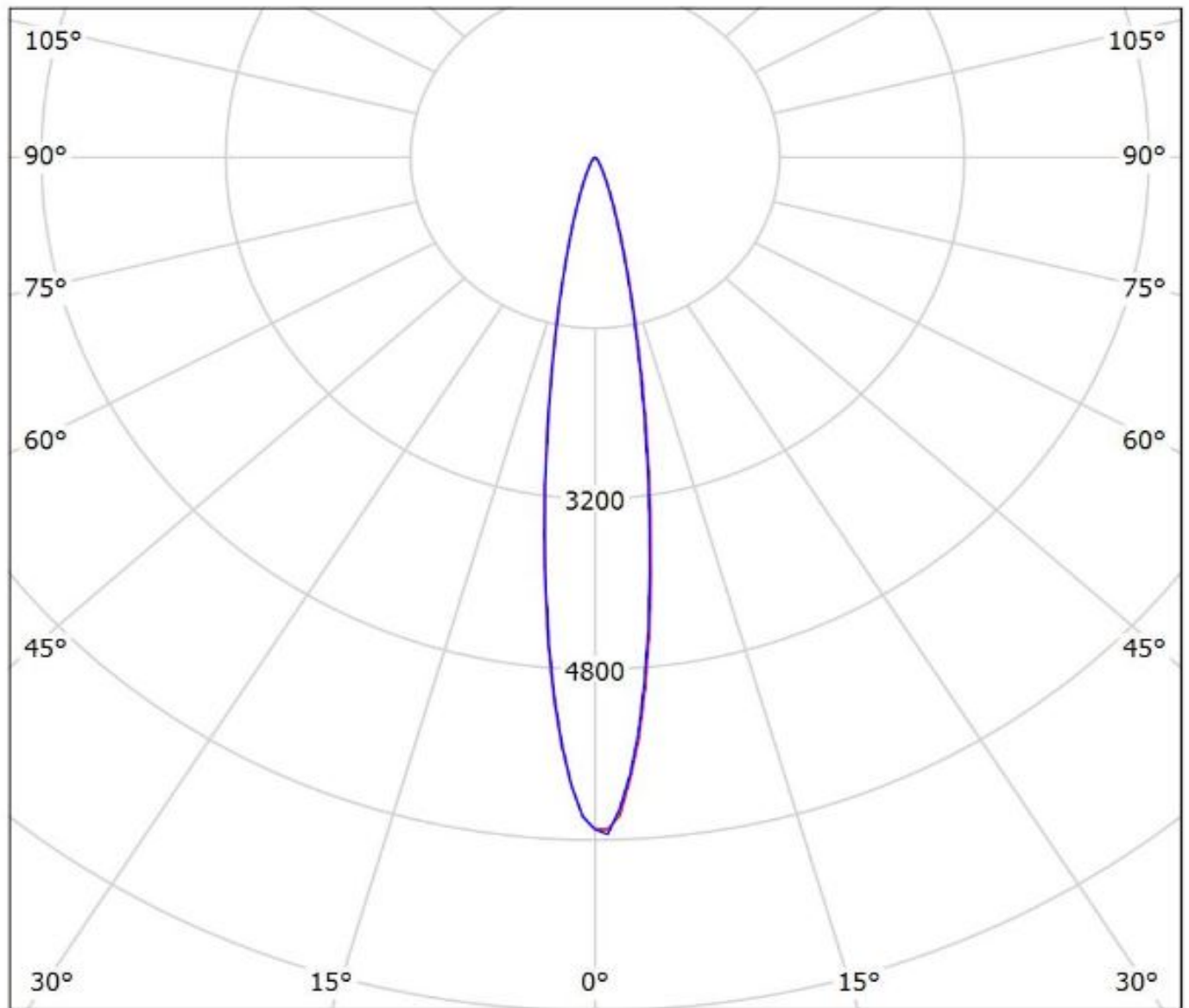

cd/klm

— C0 - C180

— C90 - C270

η = 85%

Luminaire: Ledil FCN13741\_GERI-RZ\_(XQ-E\_HD\_RGBW)

Lamps: 1 x Cree\_XQ-E\_HD\_RGBW\_233.24lm@250mA\_P=2.7265W\_I=0.250A

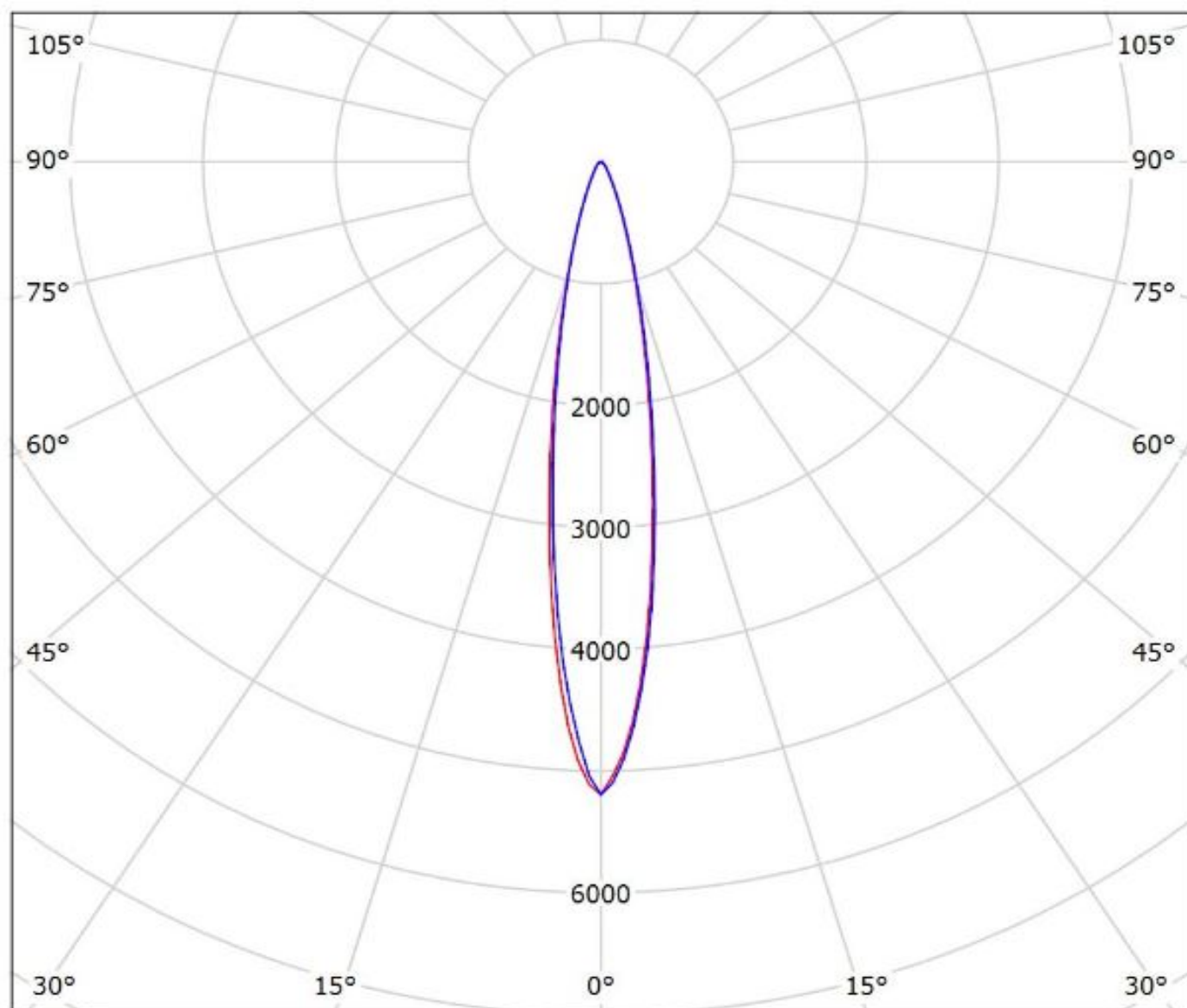

cd/klm

— C0 - C180

— C90 - C270

$\eta = 86\%$

Luminaire: Ledil FCN13741\_GERI-RZ\_(XP-G3)

Lamps: 1 x Cree\_XP-G3\_109.458lm@250mA\_P=0.738275W\_I=0.250A

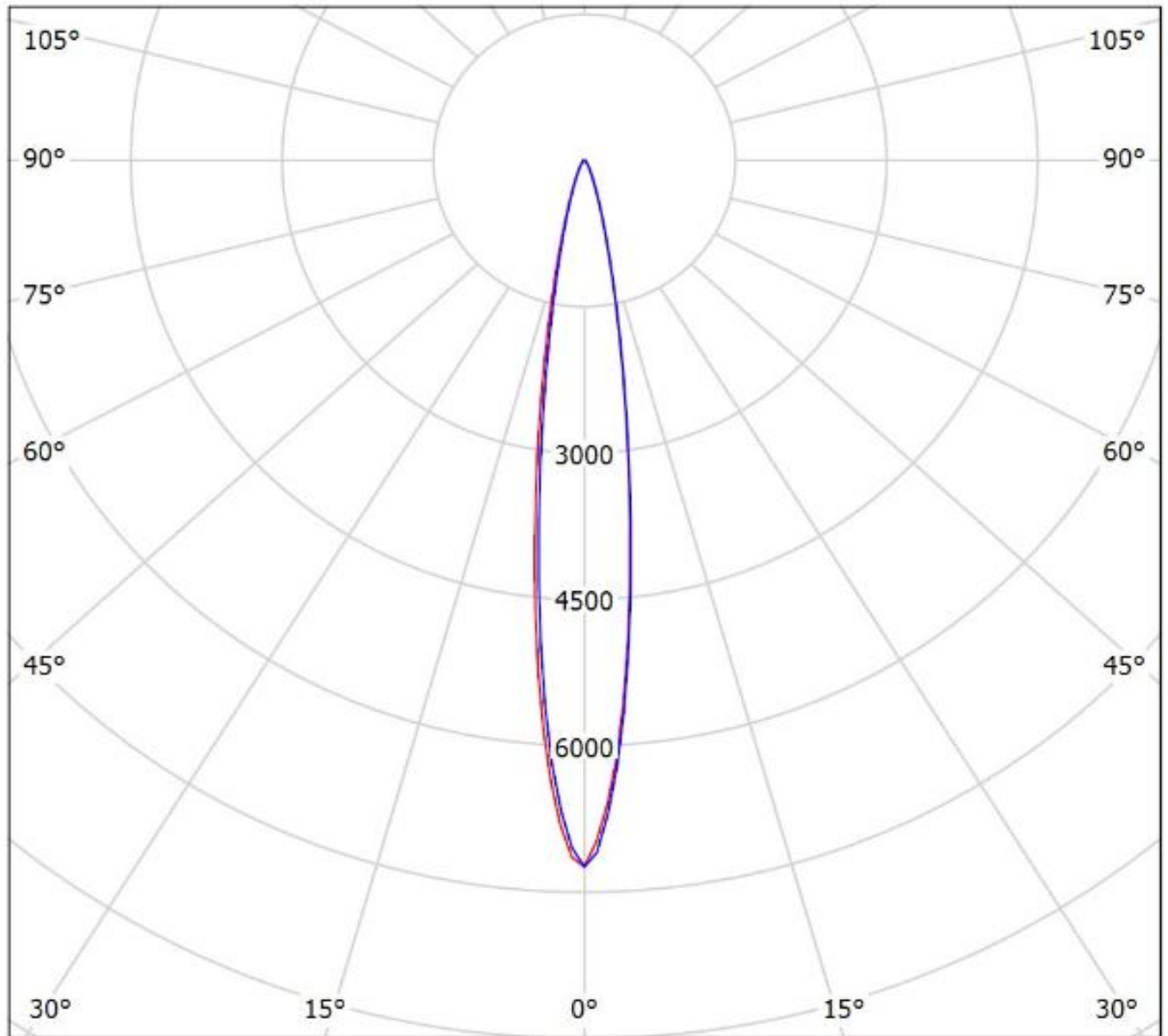

cd/klm

— C0 - C180

— C90 - C270

$\eta = 85\%$

Luminaire: Ledil FCN13741\_GERI-RZ\_(XT-E)

Lamps: 1 x Cree\_XT-E\_(XTEAWT-0-2A0-R30-FB-0001)\_100.346lm@250mA\_P=0.795125W\_I=0.250A

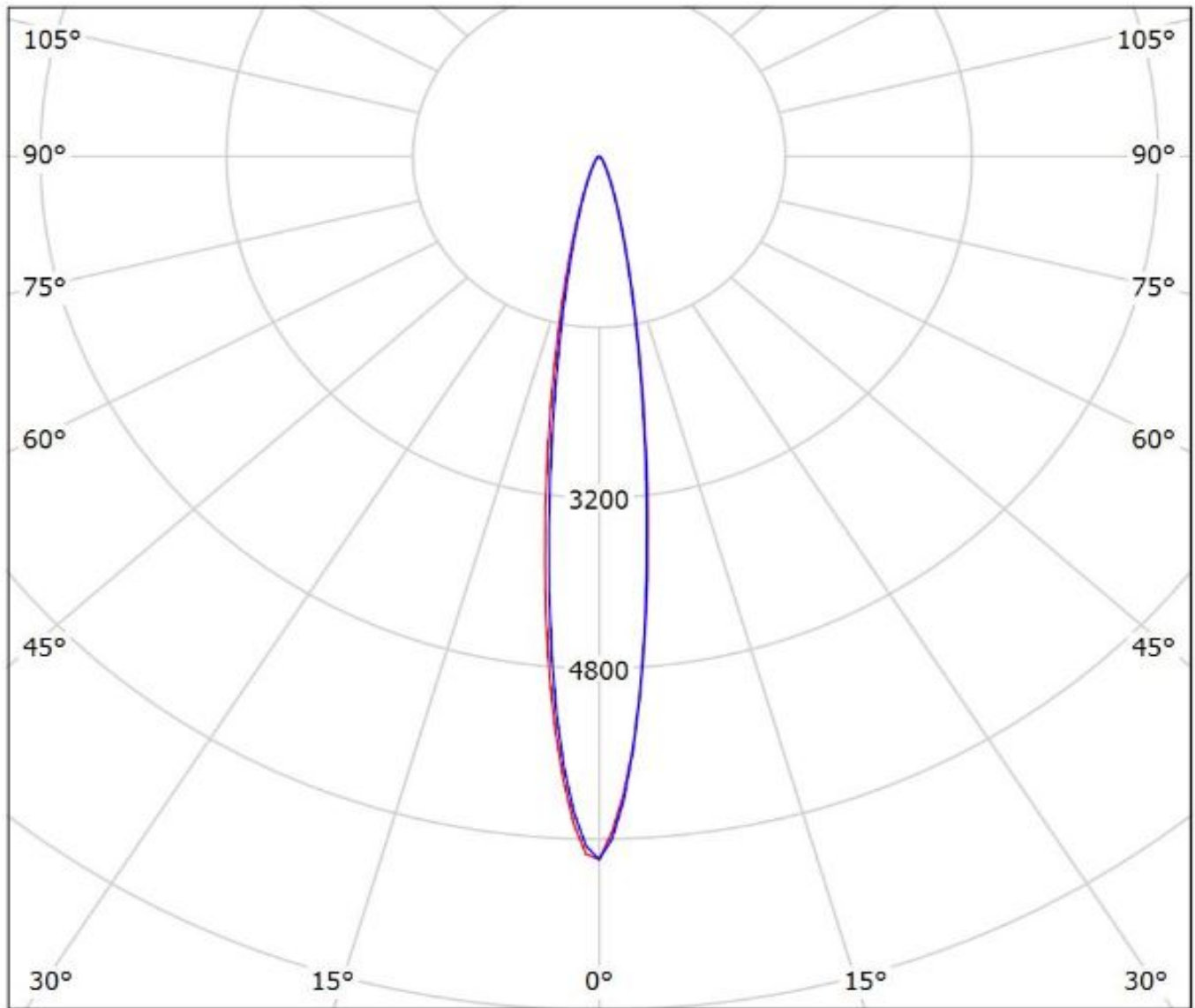

cd/klm

— C0 - C180

— C90 - C270

$\eta = 84\%$

# Ledil CN13741\_GERI-RZ\_(LUXEON\_Z\_RGBW) / LDC (Polar)

Luminaire: Ledil CN13741\_GERI-RZ\_(LUXEON\_Z\_RGBW)

Lamps: 1 x LUXEON\_Z\_RGBW\_165.276lm@250mA\_P=2.6W\_I=0.25A

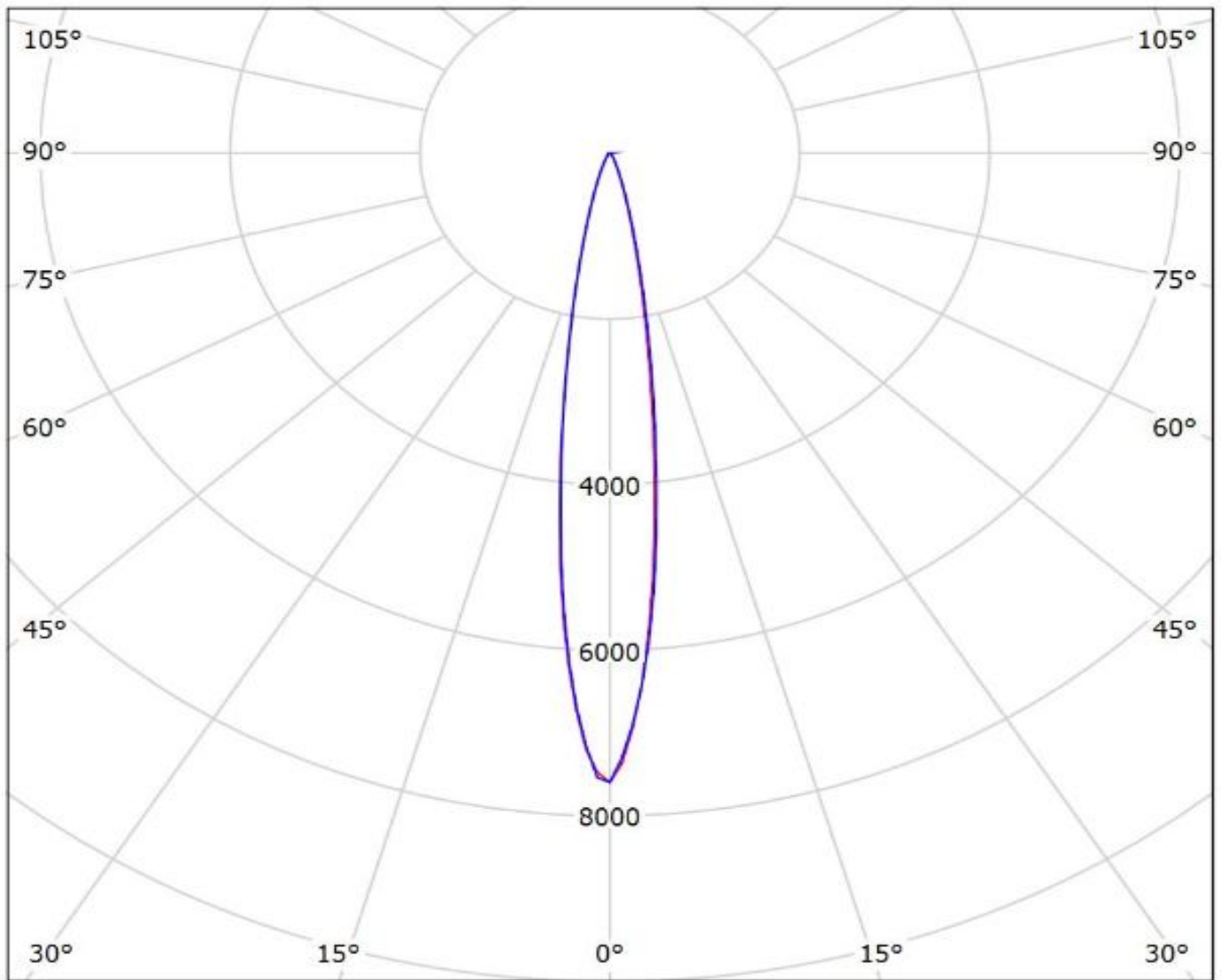

cd/klm

— C0 - C180 — C90 - C270

$\eta = 89\%$

Luminaire: LEDiL Oy FCN13741\_GERI-RZ\_(Luxeon\_C\_RGBW)  
Lamps: 1 x Luxeon\_C\_RGBW\_208.984lm@250mA\_P=2.5474W\_I=0.250A

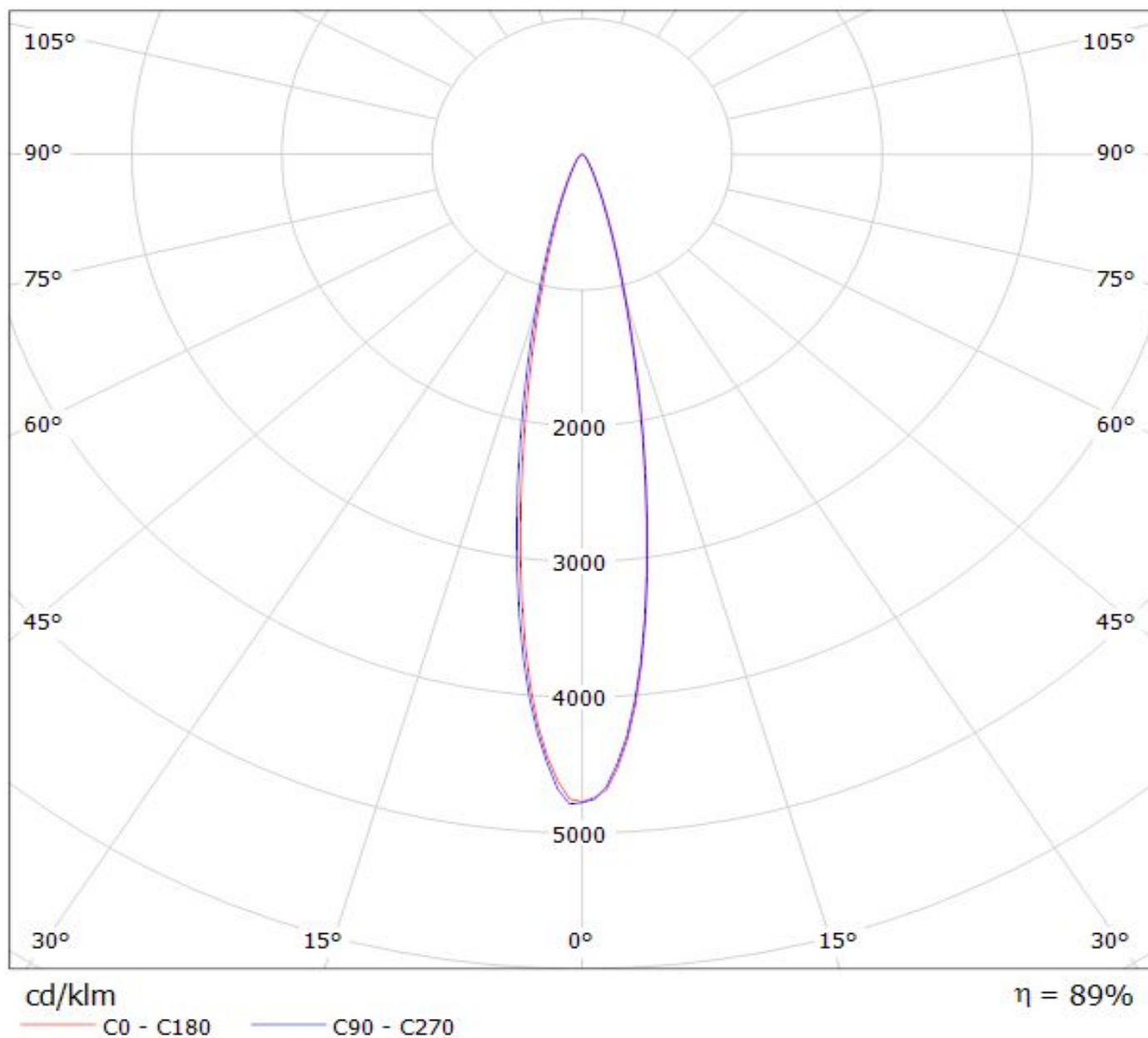

# Ledil CN13741\_GERI-RZ\_(OSTAR-SMT\_RGB) / LDC (Polar)

Luminaire: Ledil CN13741\_GERI-RZ\_(OSTAR-SMT\_RGB)

Lamps: 1 x OSRAM\_OSTAR-SMT\_RGB\_168.879lm@250mA\_P=3W\_I=0.25A

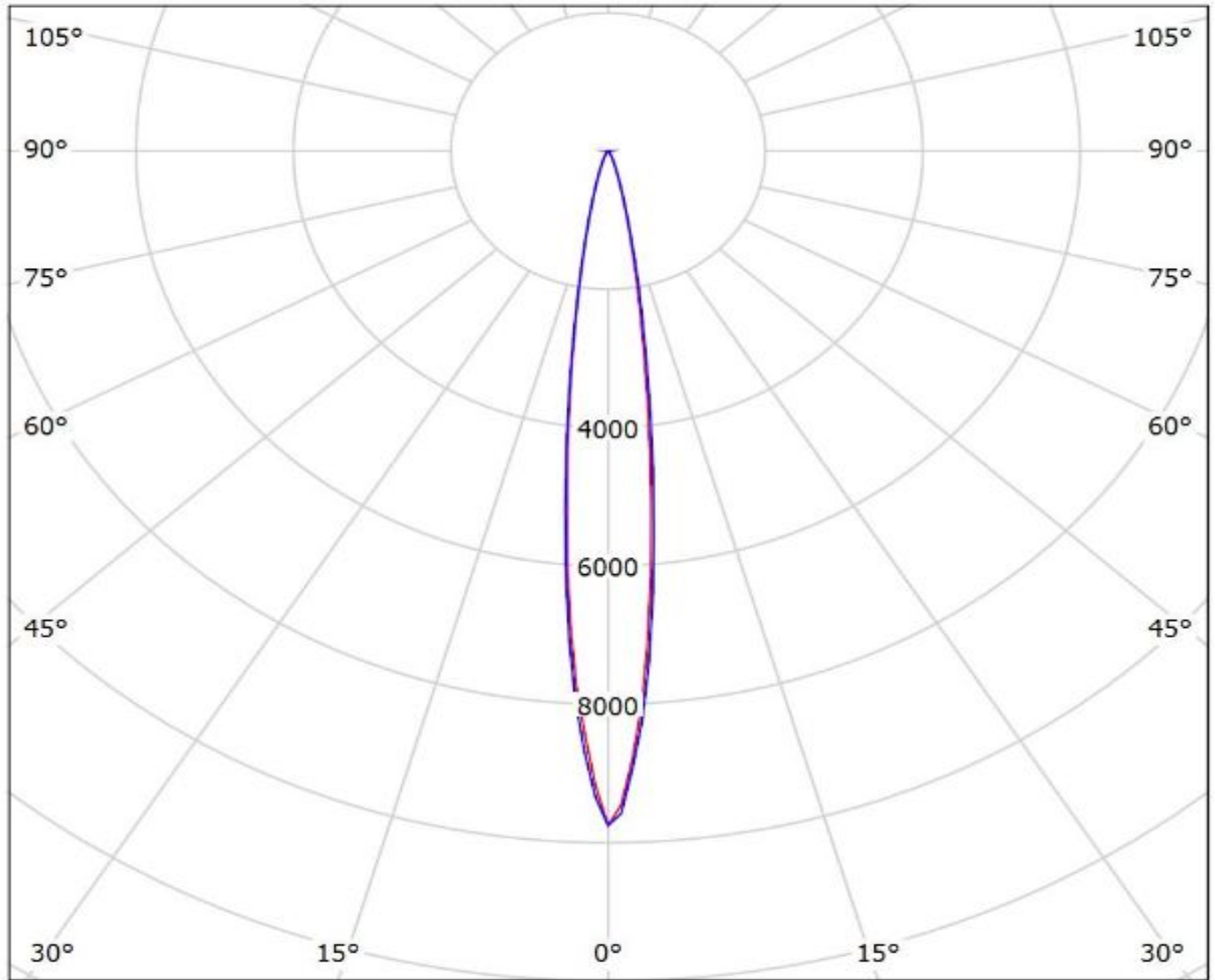

cd/klm

— C0 - C180 — C90 - C270

$\eta = 89\%$

# Ledil CN13741\_GERI-RZ\_(F50360\_RGB) / LDC (Polar)

Luminaire: Ledil CN13741\_GERI-RZ\_(F50360\_RGB)

Lamps: 1 x SEOUL\_F50360\_RGB\_(-01\_QLSRBH)\_57.1364lm@250mA\_P=2.1W\_I=0.25A

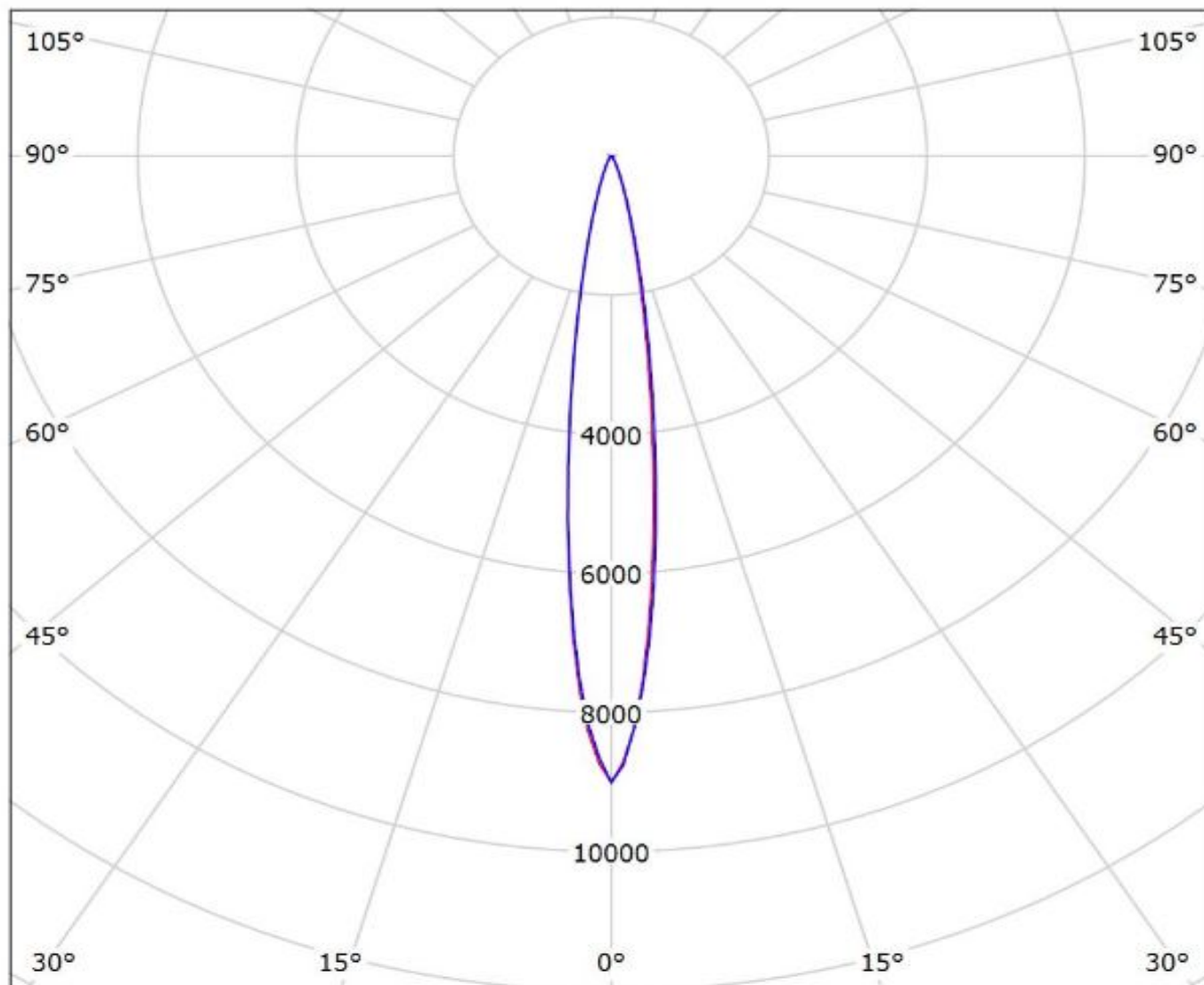

cd/klm

— C0 - C180

— C90 - C270

η = 90%



**NOTE: The typical divergence will be changed by different color, chip size and chip position tolerance. The typical total divergence is the full angle measured where the luminous intensity is half of the peak value.**