

DETAILS

Product Number	FS15786_FLORENCE-3R-IP-Z60
Family	Florence
Type	Assembly
Color	clear
Diameter	321 + 79 mm
Height	10,5 mm
Style	rectang
Optic Material	PC
Holder Material	
Fastening	
Status	production ready
ROHS Compliant	Yes
Date Updated	30/03/2017



OPTICAL PROPERTIES

LED	Viewing Angle	Light Beam	Efficiency	cd/lm	Connector
XP-G2	sim: 60		sim: 92 %	sim: 0.900	-
LG 6030	60 deg		86 %	0.720	-
LUXEON 5050	sim: 64		sim: 94 %	sim: 0.770	-
NVSxx19B/NVSxx19C	59 deg		87 %	0.750	-
Oslon Square Gen3	59 deg		88 %	0.780	-
Fortimo LED Line 1ft 2000lm 8xx 3R HV	262 deg		86 %	0.710	-
Fortimo LED Line 1ft 1100lm xx0 3R xV2	59 deg		87 %	0.740	-
Fortimo LED Line 1ft 650lm 8x0 3R xV2	59 deg		86 %	0.760	-
Z8Y22	sim: 62		sim: 93 %	sim: 0.770	-
Z8Y22P	sim: 63		sim: 93 %	sim: 0.750	-

H G F E D C B A

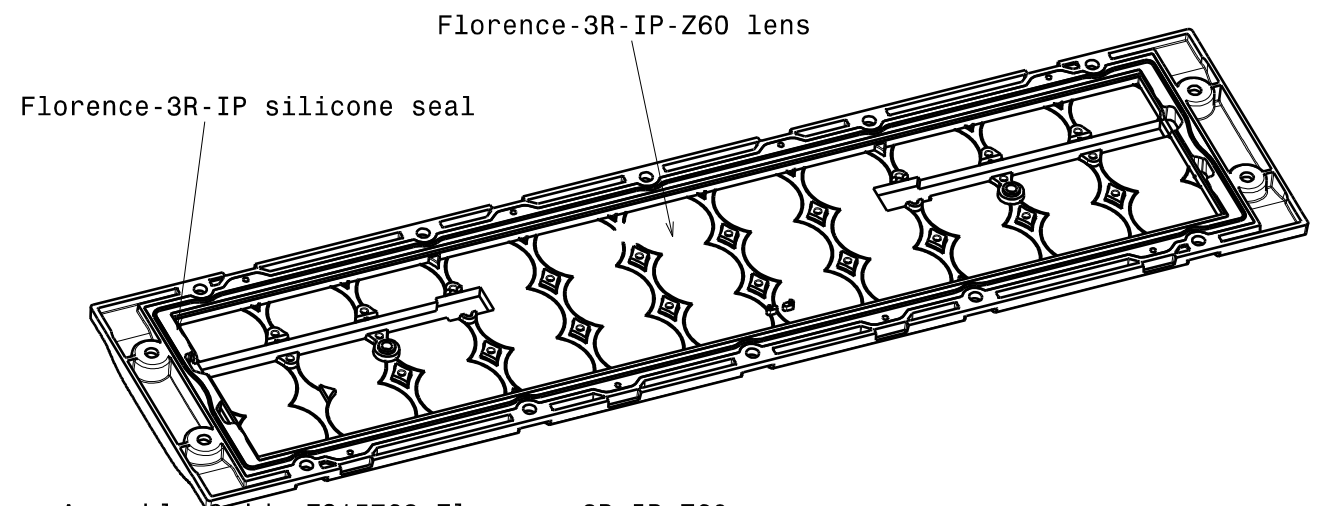
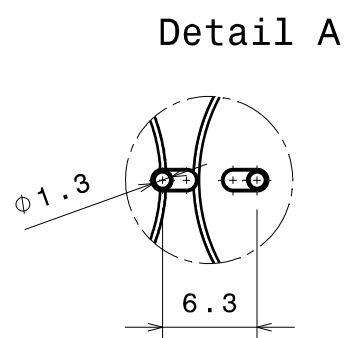
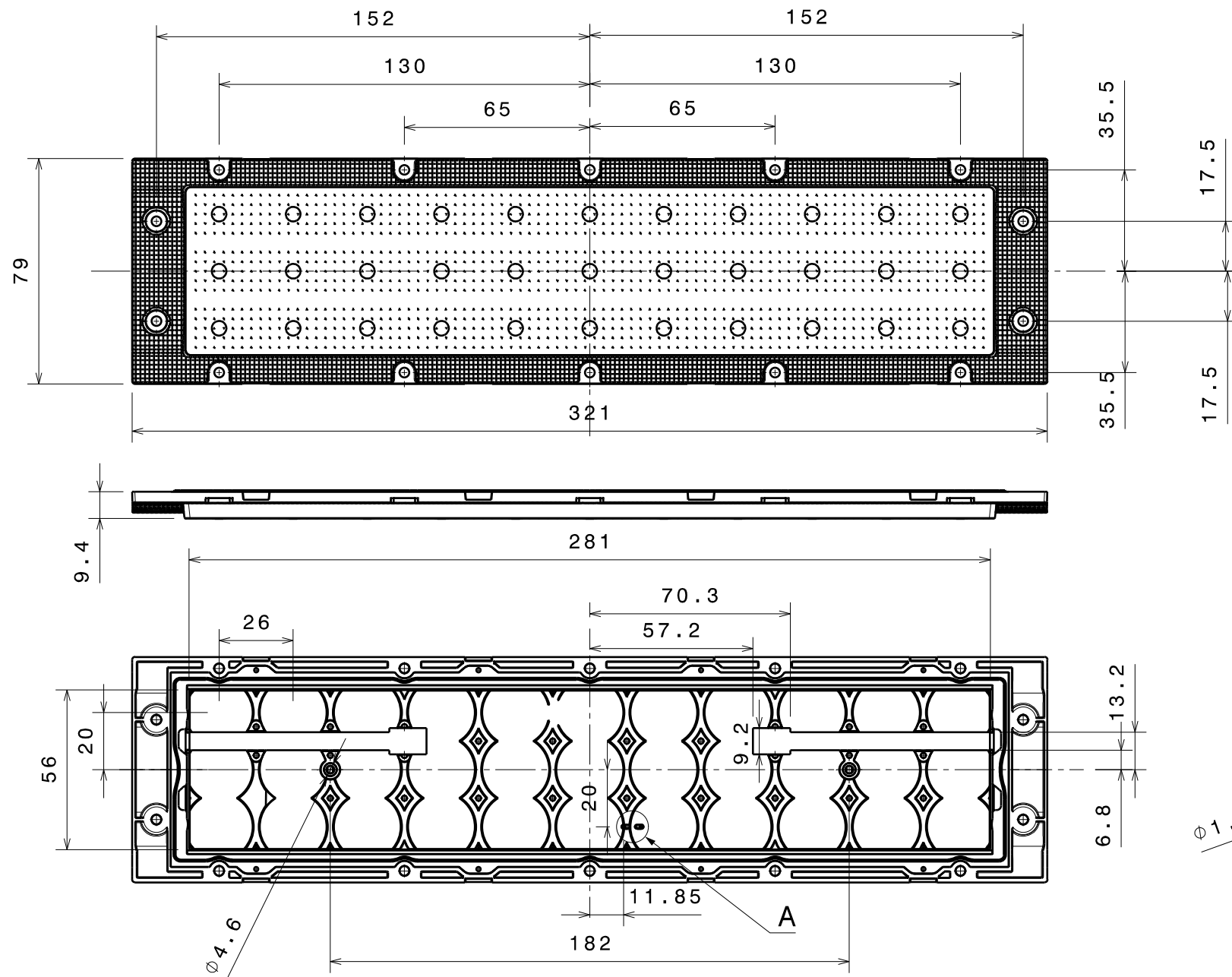

- Assembly Guide FS15768 Florence-3R-IP-Z60:
1. Insert silicone seal into bottom of Florence-3R-IP-Z60 lens
 2. Set lens and silicone seal on top of PCB
 3. Fasten lens to heatsink with 14pcs of M3 screws

Screw type DIN 7985 M3, Max torque 0.6Nm

INDEX	PART NO	DESCRIPTION	MATERIAL	COLOUR
1	F15625	FLORENCE-3R-IP-Seal	Silicone	
2	F15674	FLORENCE-3R-IP-Z60	PC	

Tolerances if not otherwise shown
According to DIN ISO 2768-1
Linear measures:
Up to 30mm class M, otherwise class C.
According to DIN ISO 2768-2
Form and position: class L

LEDiL LediL Oy
Salorankatu 10
FIN 24240 SALO
Finland

THIRD ANGLE PROJECTION:

DRAWING TITLE
FS15786_Florence-3R-IP-Z60-Mechanical-drawing

This drawing is the property of LEDiL Oy. It may not be reproduced, copied or communicated without a written agreement with LEDiL Oy.

SIZE	PART NUMBER
A3	FS15786

SCALE	1:2	WEIGHT	g	SHEET	1/1
-------	-----	--------	---	-------	-----

H G F E D C B A

Luminaire: Ledil Oy FS15786_FLORENCE-3R-IP-Z60_(XP-G2)_SIMULATED
Lamps: 1 x Cree XP-G2

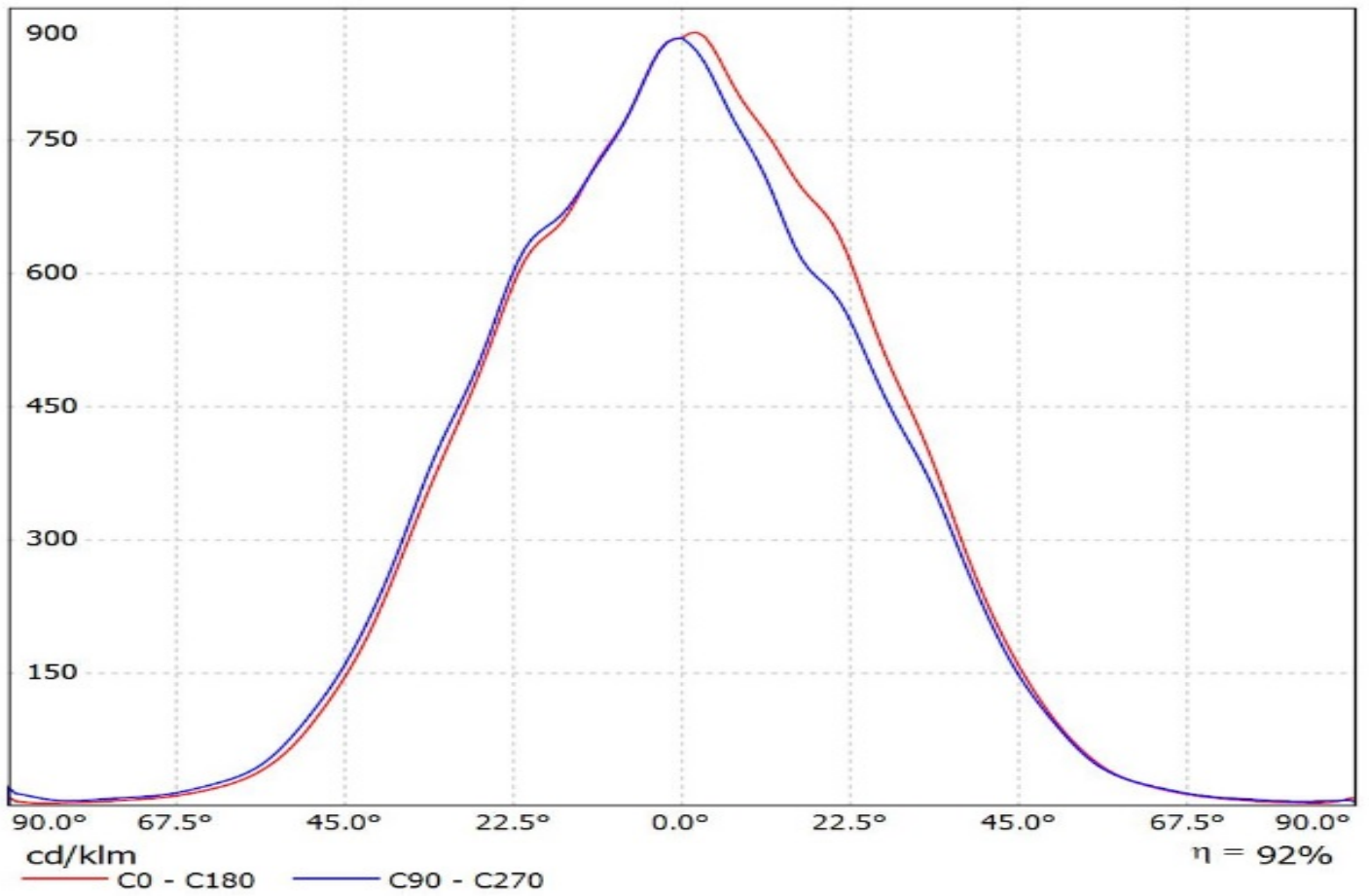

Luminaire: Ledil FS15786_FLORENCE-3R-IP-Z60_(LG-6030)_Cav1
Lamps: 1 x LG-6030_(LEWMS68T80HZ)_1073.53lm@250mA_cct=5000K_P=7.9555W_I=0.25A

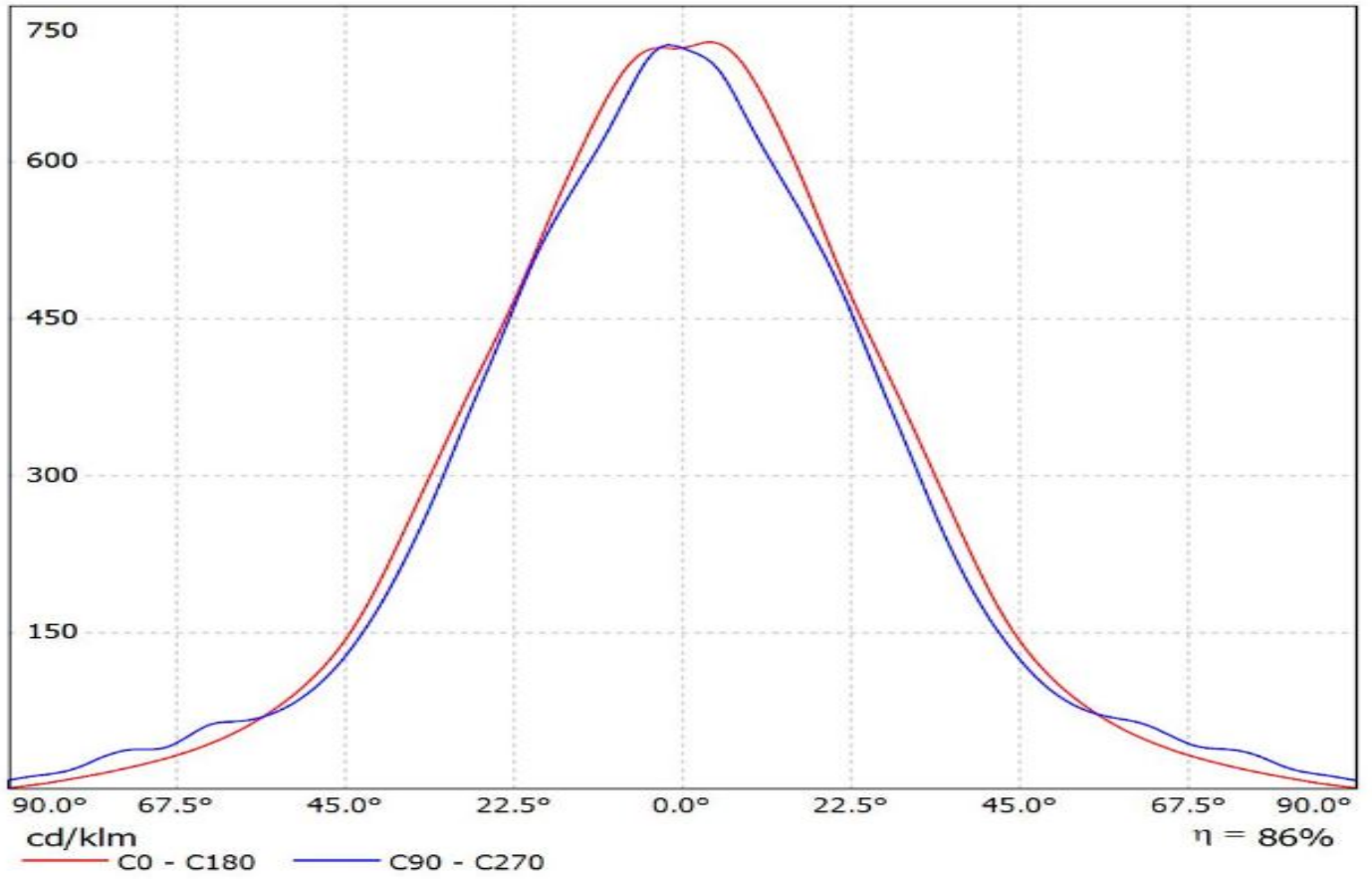

Luminaire: Ledil Oy FS15786_FLORENCE-3R-IP-Z60_(LUXEON 5050)_SIMULATED
Lamps: 1 x Lumileds LUXEON 5050

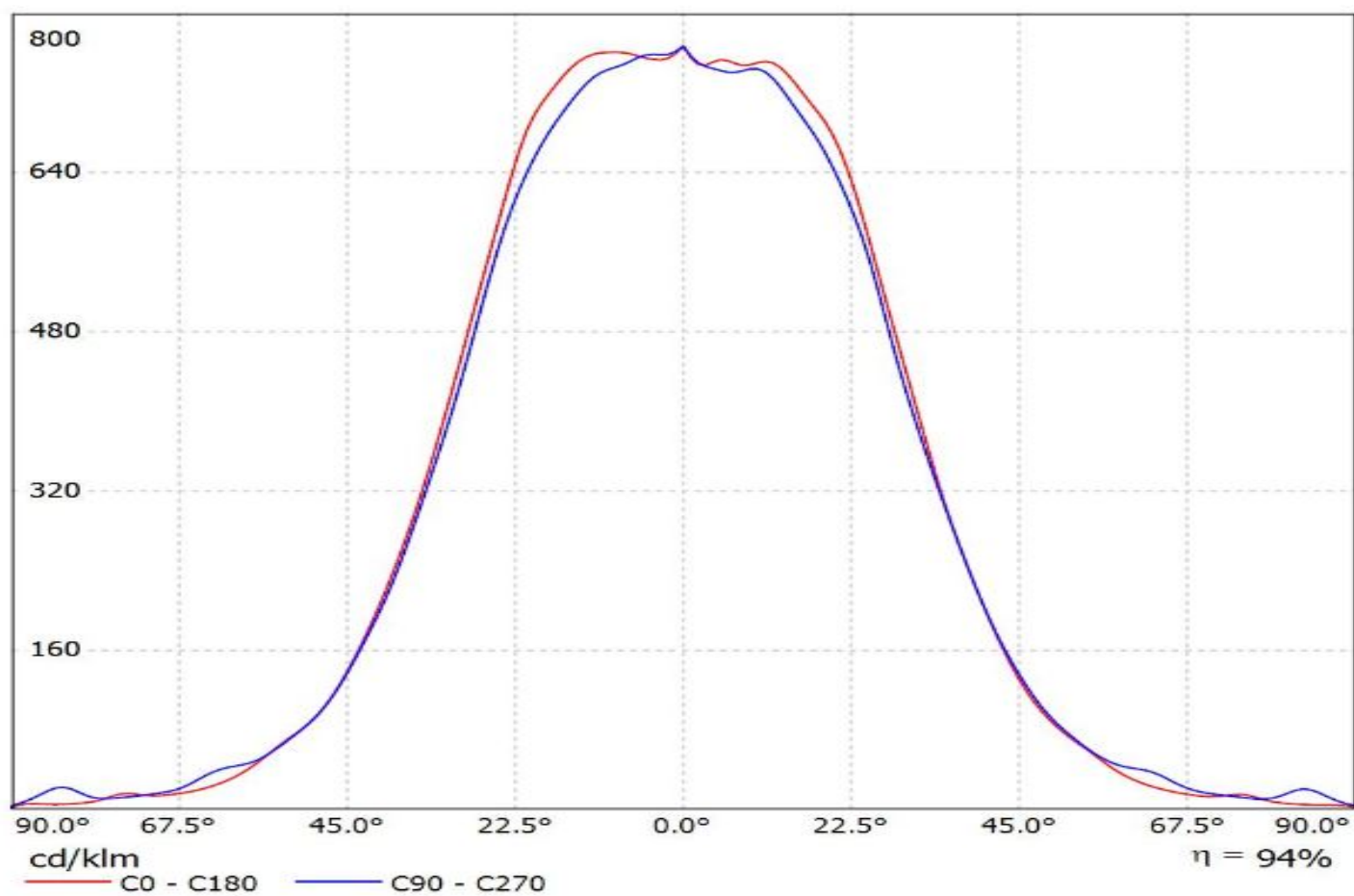

Luminaire: LEDiL Oy FS15786_FLORENCE-3R-IP-Z60_(NVSL219C)

Lamps: 1 x Nichia_NVSL219C_1186.24lm@250mA_P=7.38509W_U=29.564V

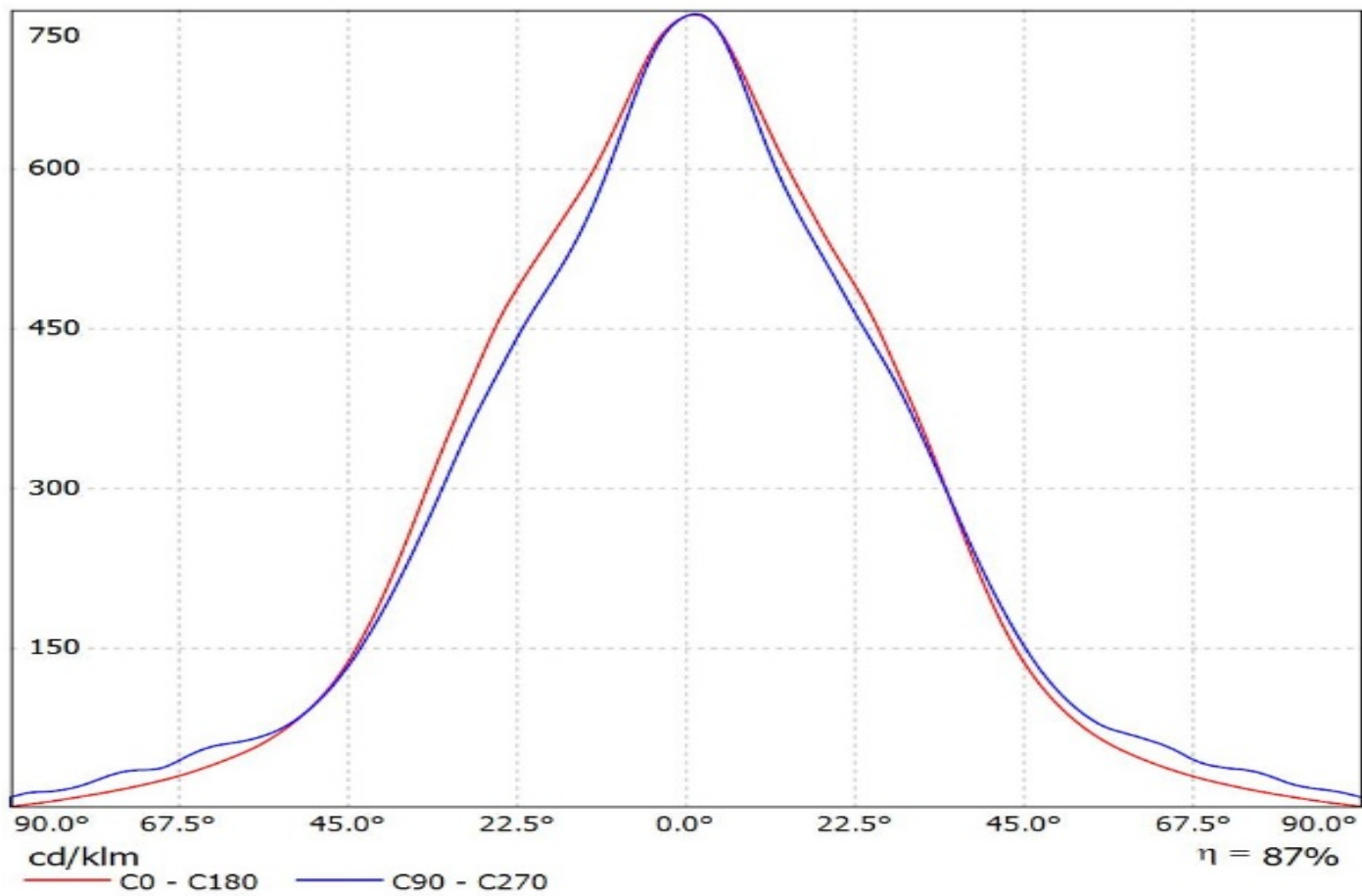

Luminaire: LEDiL Oy FS15786_FLORENCE-3R-IP-Z60_(Oslon_Square_Gen3)
Lamps: 1 x Osram_Oslon_Square_Gen3_(GW_CSSRM2.EM)
_1246.56lm@250mA_P=7.4303W_I=0.250A

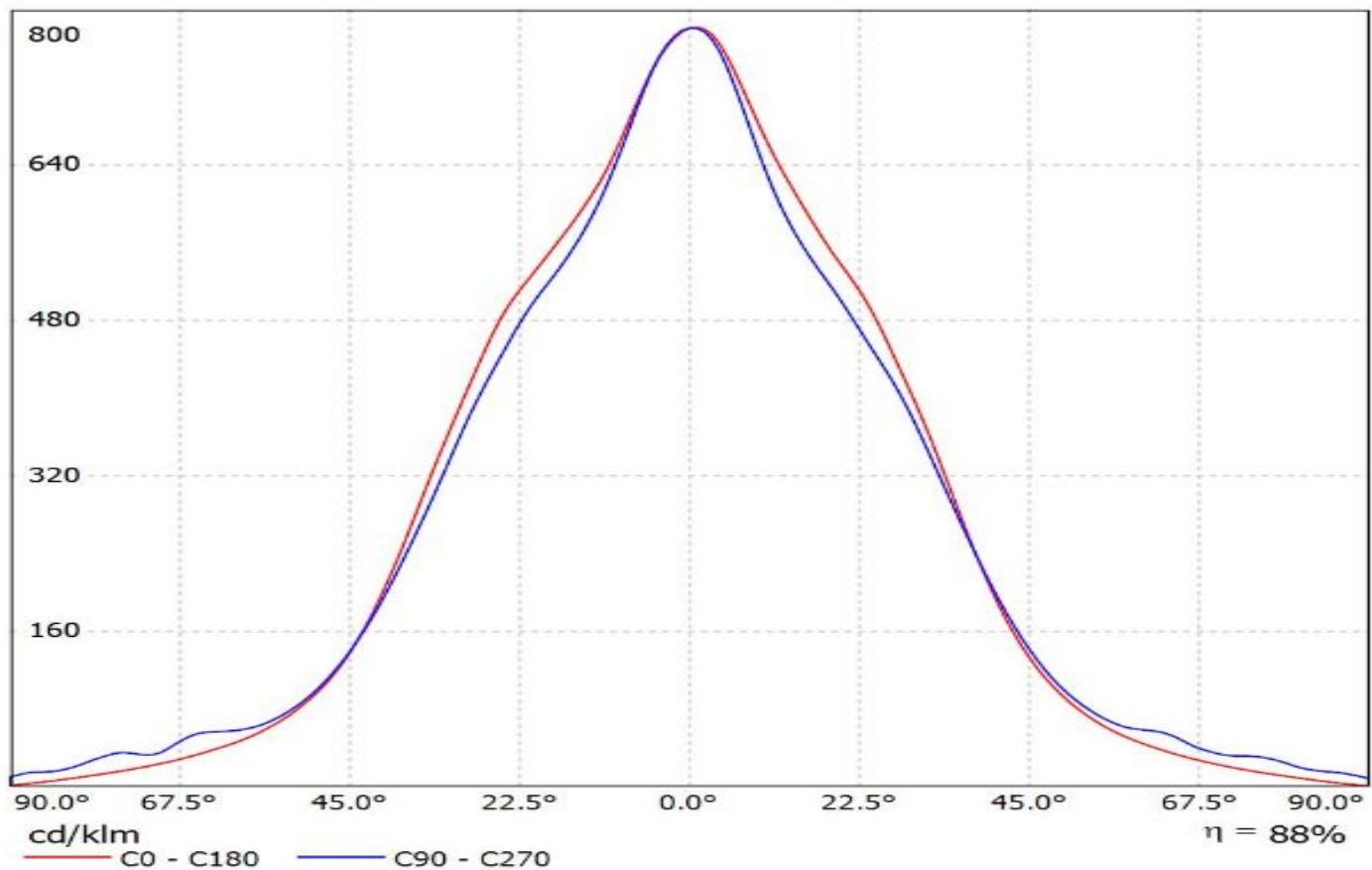

Luminaire: Ledil FS15786_FLORENCE-3R-IP-Z60 (Fortimo_LED_Line_1ft_2000lm_835_3R_HV2)

Lamps: 1 x Philips_Fortimo_LED_Line_1ft_2000lm_835_3R_HV2_(LG7030)_1226.7lm@250mA_P=7.54023W_I=0.250A

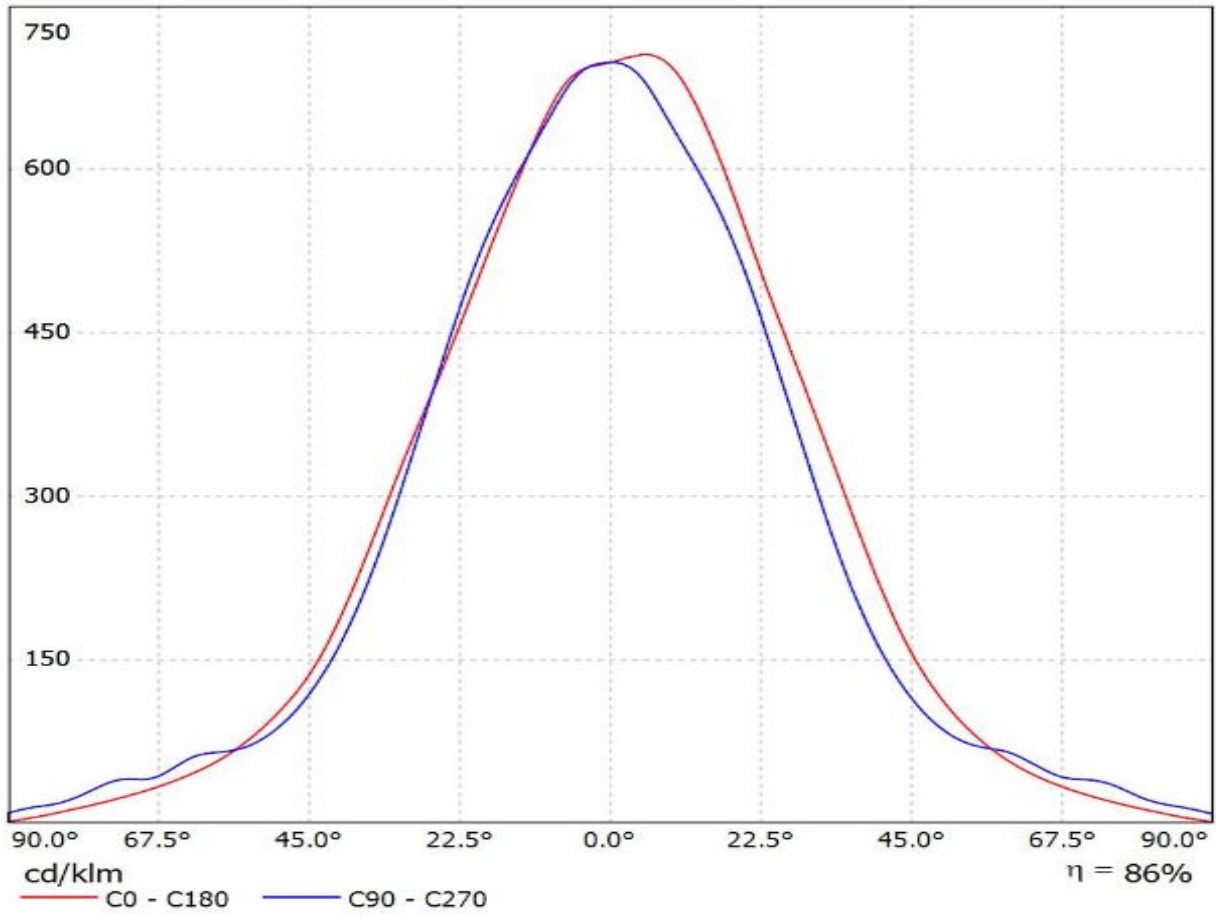

Luminaire: LEDiL Oy FS15786_FLORENCE-3R-IP-Z60 (Fortimo_LED_Line_1ft_1100lm_840_3R_HV2)
Lamps: 1 x Fortimo_LED_Line_1ft_1100lm_840_3R_HV2_1035.97lm@250mA_P=7.91516W_I=0.25A

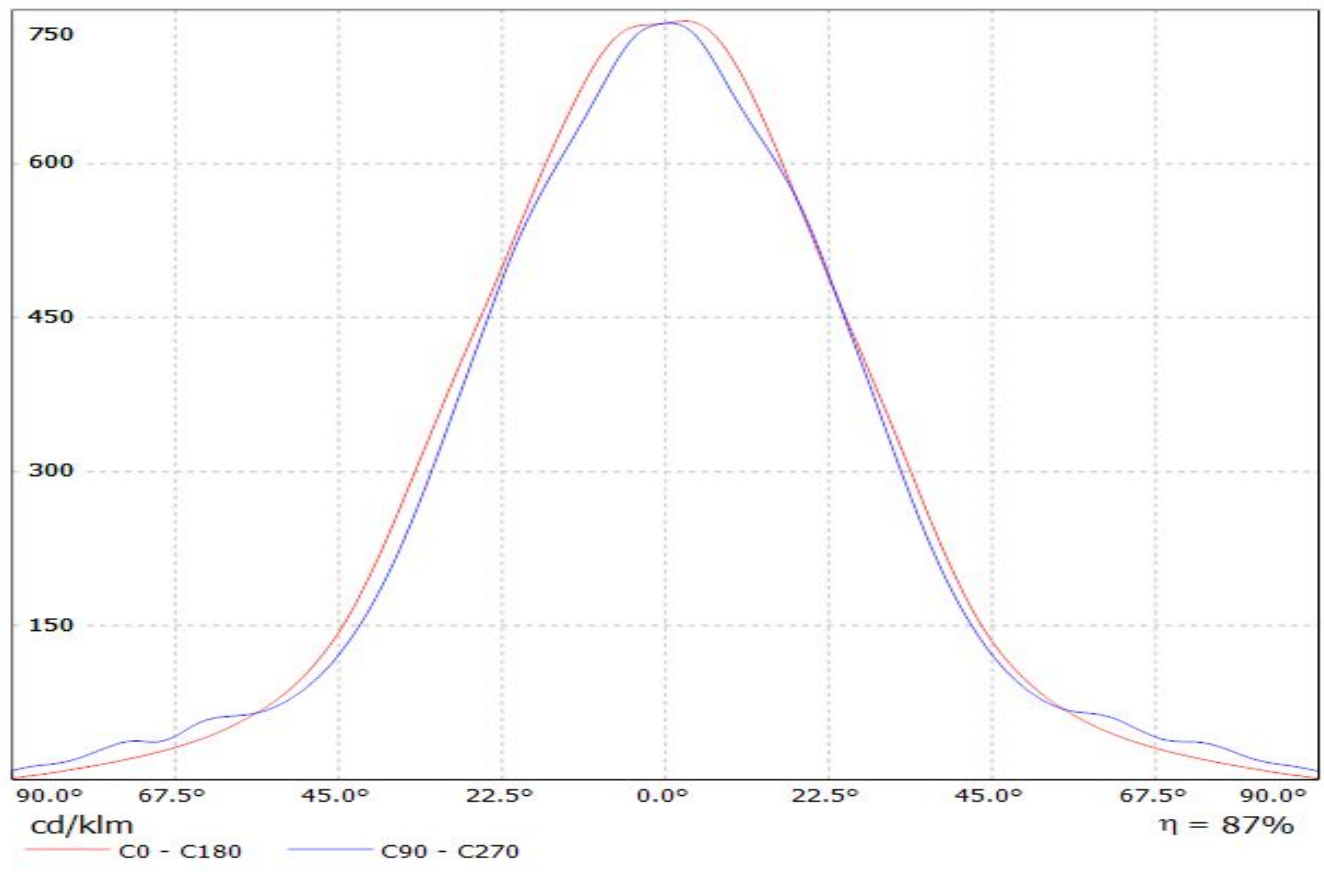

Luminaire: LEDiL Oy FS15786_FLORENCE-3R-IP-Z60 (Philips_Fortimo_LED_Line_1ft_650lm_840_3R_LV3)
Lamps: 1 x Philips_Fortimo_LED_Line_1ft_650lm_840_3R_LV3_1122.62lm@250mA_P=8.18145W_I=0.250A

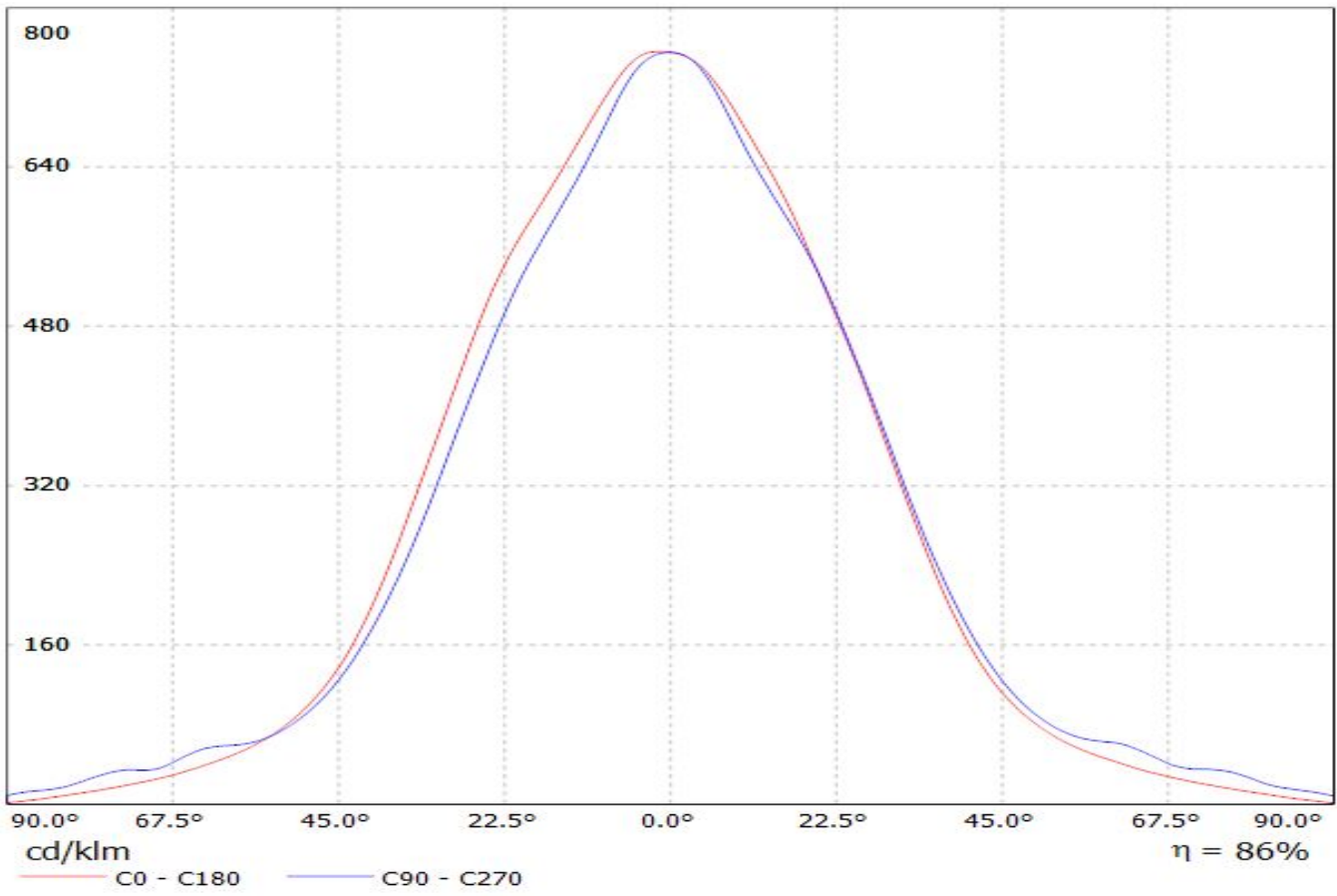

Luminaire: Ledil Oy FS15786_FLORENCE-3R-IP-Z60_(Z8Y22)_SIMULATED
Lamps: 1 x Seoul Z8Y22

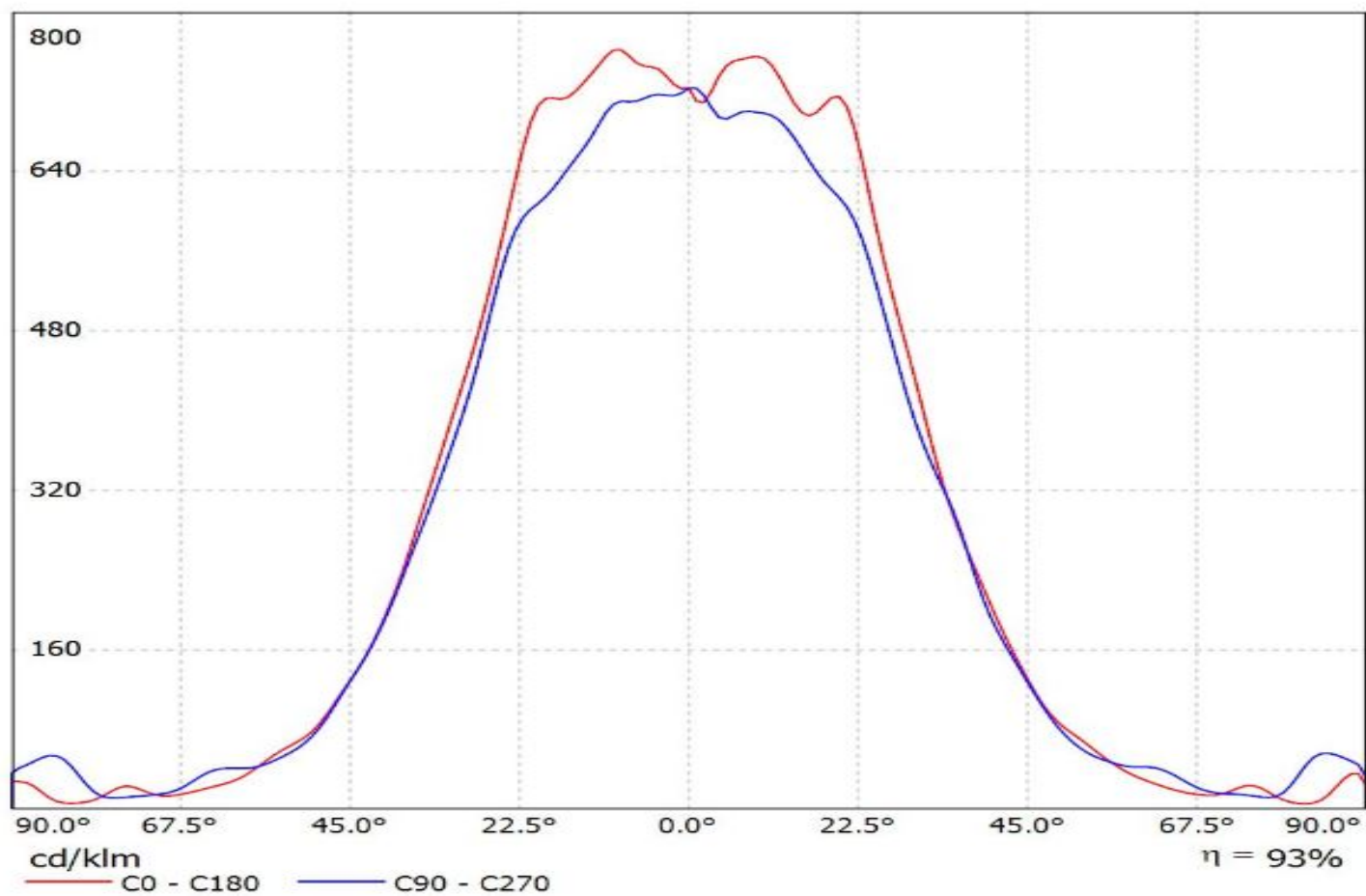

Luminaire: Ledil Oy FS15786_FLORENCE-3R-IP-Z60_(Z8Y22P)_SIMULATED
Lamps: 1 x Seoul Z8Y22P

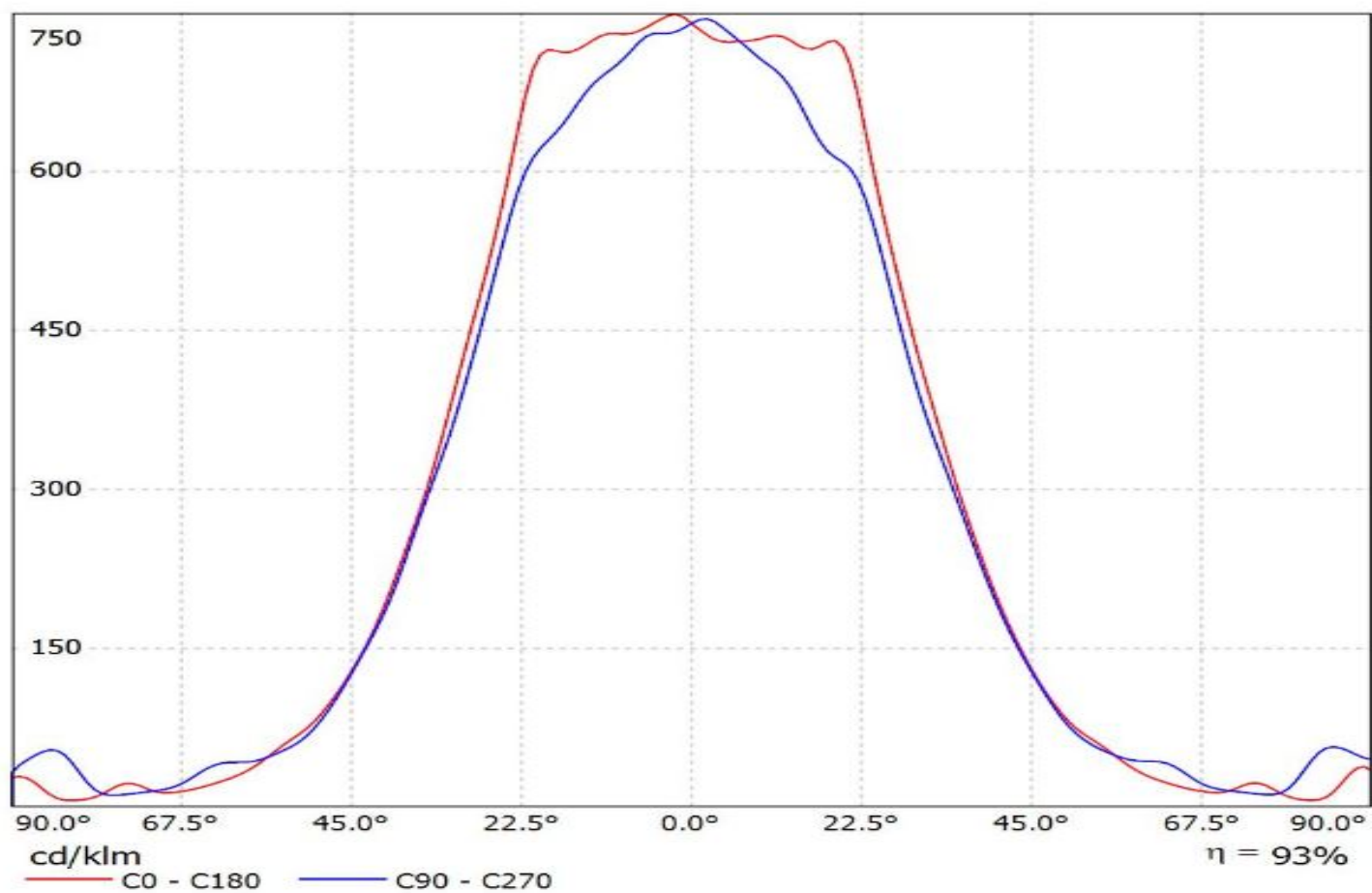

Luminaire: Ledil Oy FS15786_FLORENCE-3R-IP-Z60_(XP-G2)_SIMULATED

Lamps: 1 x Cree XP-G2

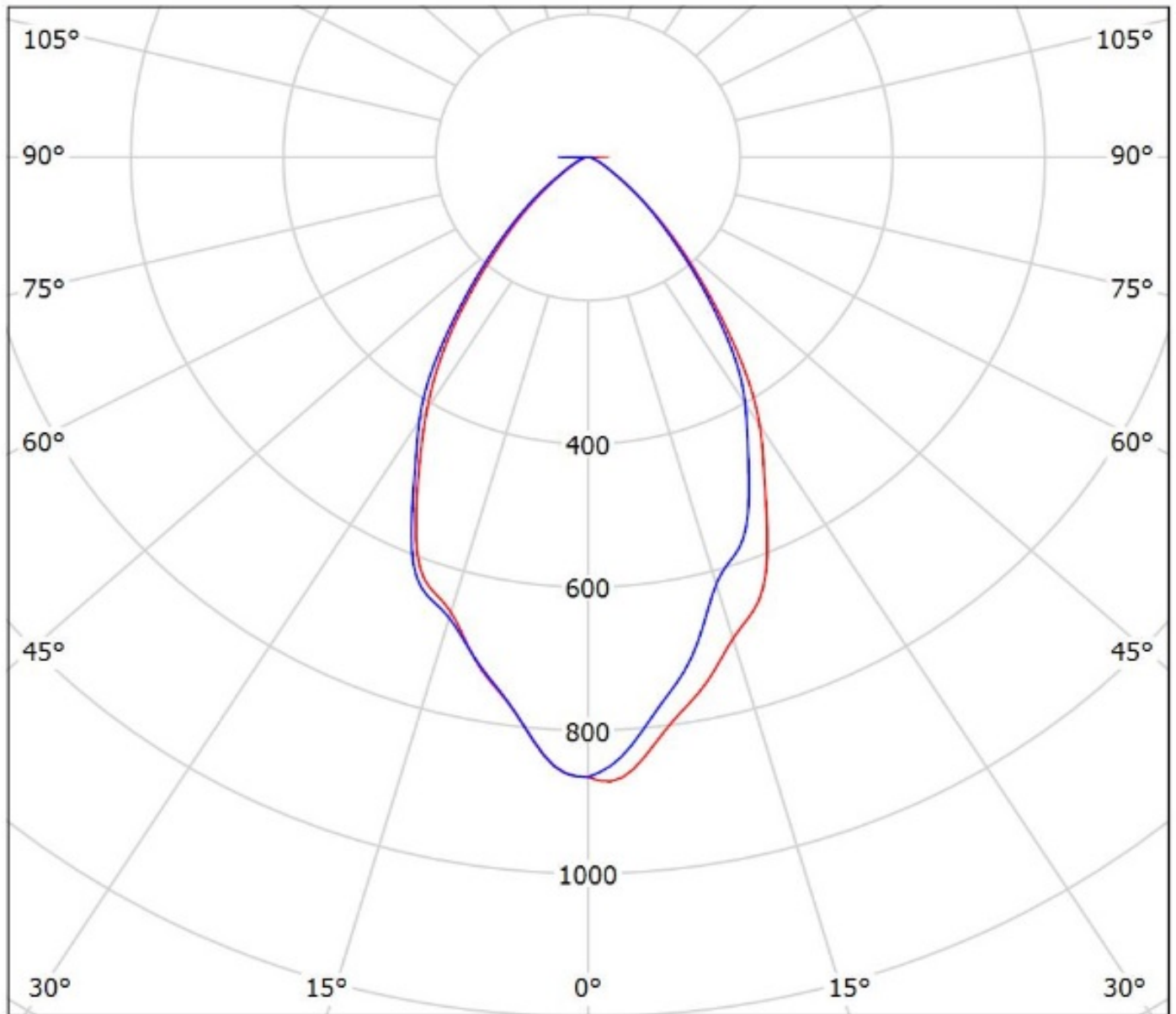

cd/klm

— C0 - C180 — C90 - C270

$\eta = 92\%$

Luminaire: Ledil FS15786_FLORENCE-3R-IP-Z60_(LG-6030)_Cav1

Lamps: 1 x LG-6030_(LEWMS68T80HZ)_1073.53lm@250mA_cct=5000K_P=7.9555W_I=0.25A

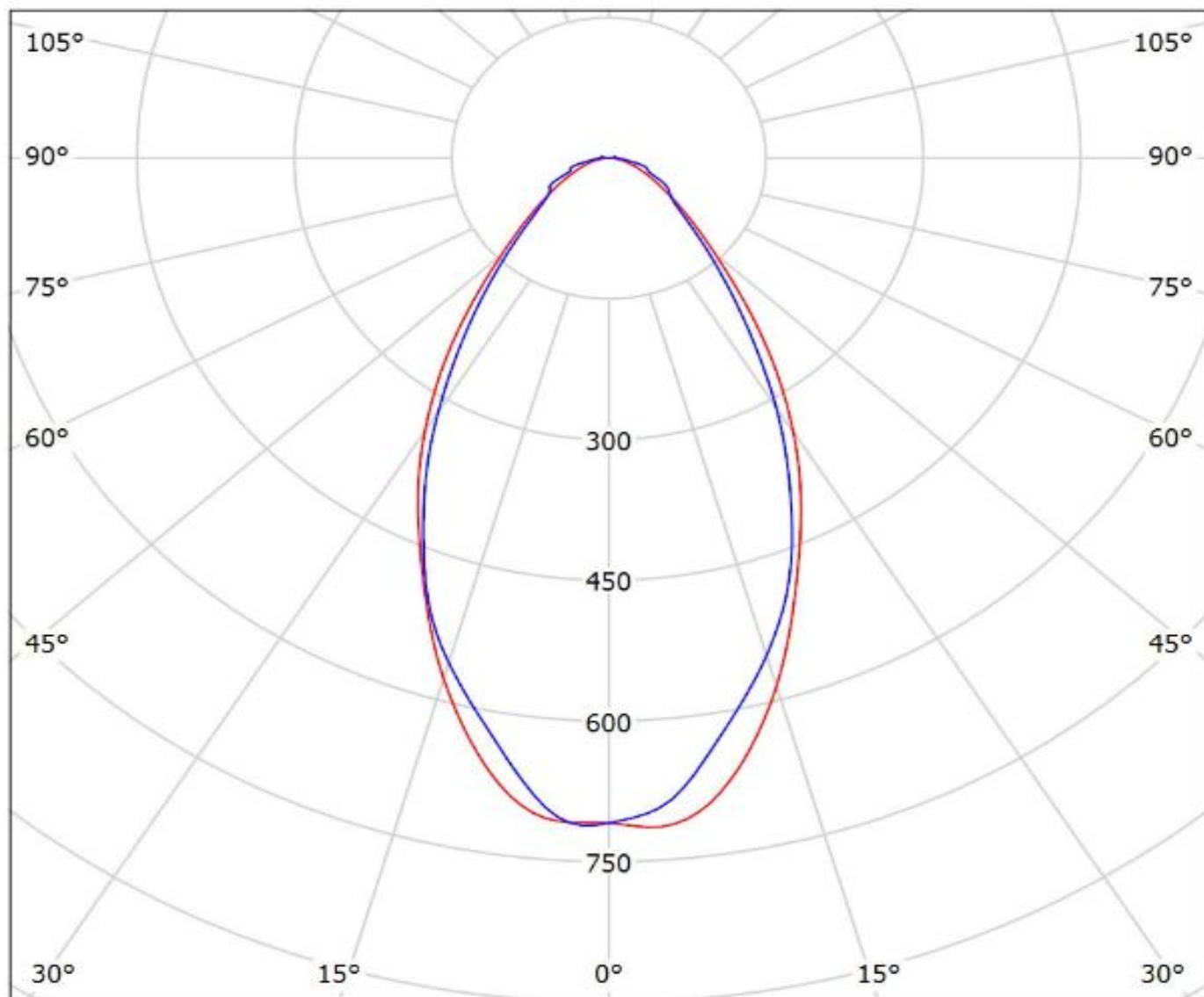

cd/klm

— C0 - C180 — C90 - C270

$\eta = 86\%$

Luminaire: Ledil Oy FS15786_FLORENCE-3R-IP-Z60_(LUXEON 5050)_SIMULATED
Lamps: 1 x Lumileds LUXEON 5050

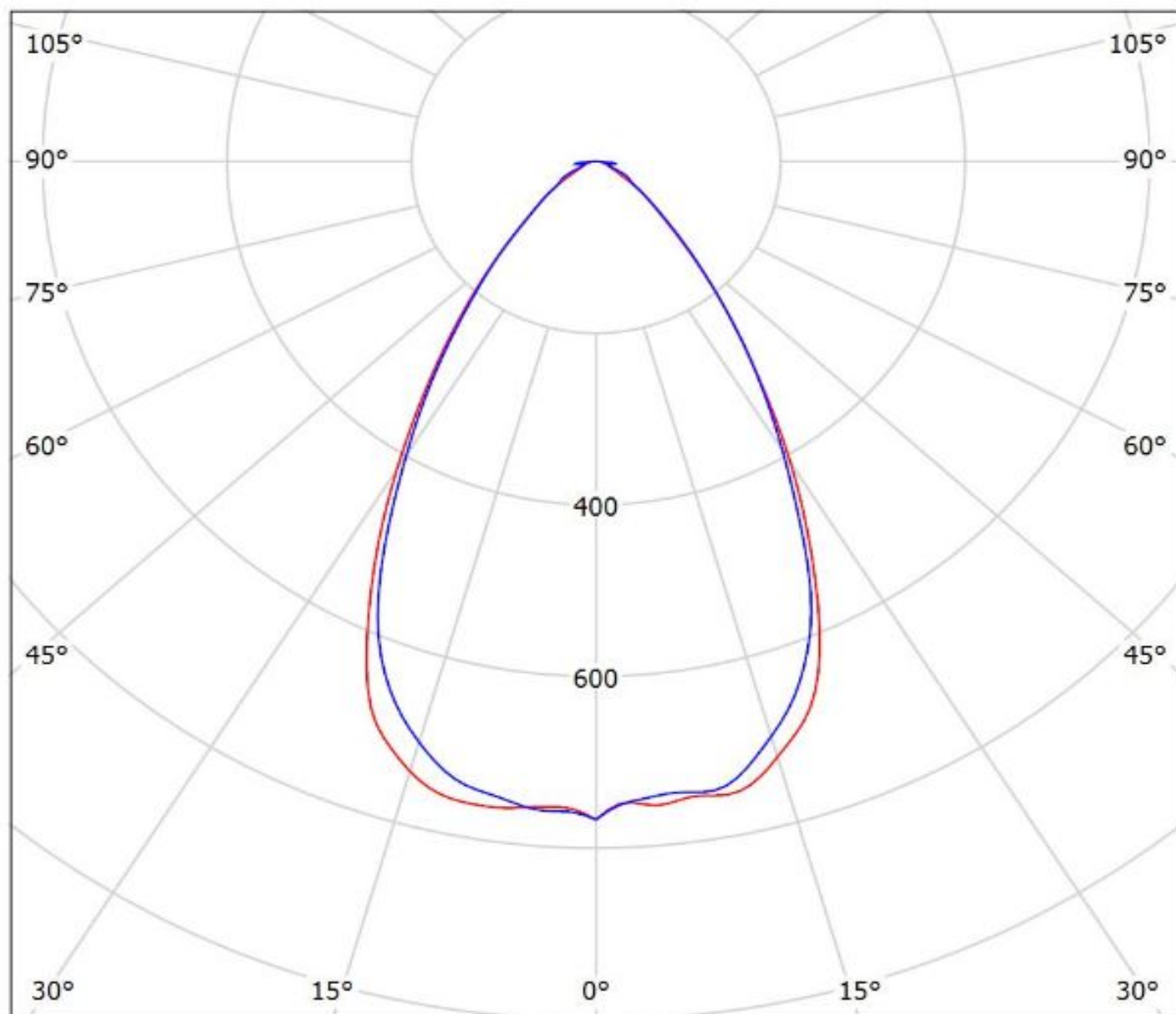

cd/klm

— C0 - C180 — C90 - C270

$\eta = 94\%$

Luminaire: LEDiL Oy FS15786_FLORENCE-3R-IP-Z60_(NVSL219C)

Lamps: 1 x Nichia_NVSL219C_1186.24lm@250mA_P=7.38509W_U=29.564V

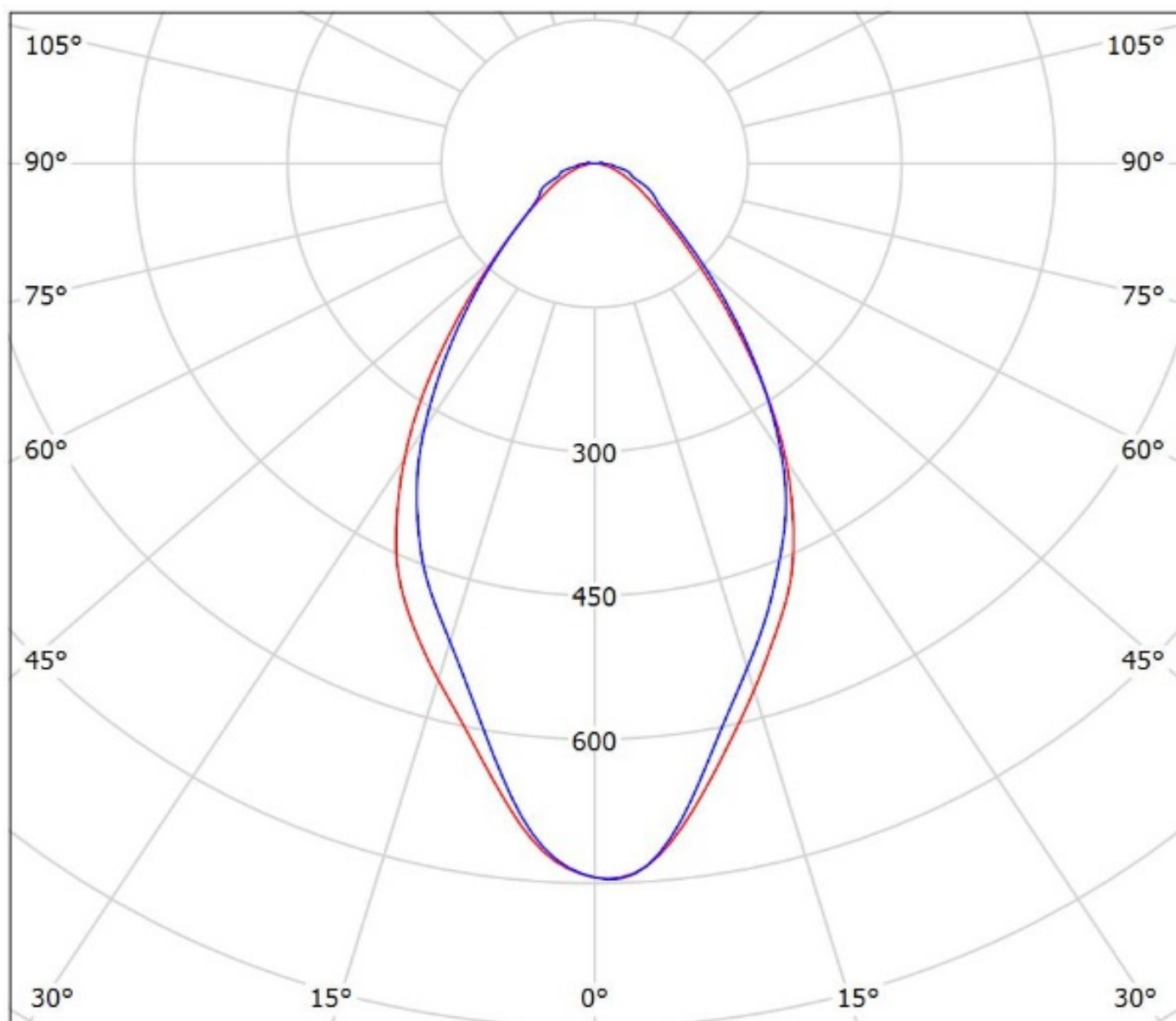

cd/klm

— C0 - C180 — C90 - C270

$\eta = 87\%$

Luminaire: LEDiL Oy FS15786_FLORENCE-3R-IP-Z60_(Oslon_Square_Gen3)
Lamps: 1 x Osram_Oslon_Square_Gen3_(GW_CSSRM2.EM)
_1246.56lm@250mA_P=7.4303W_I=0.250A

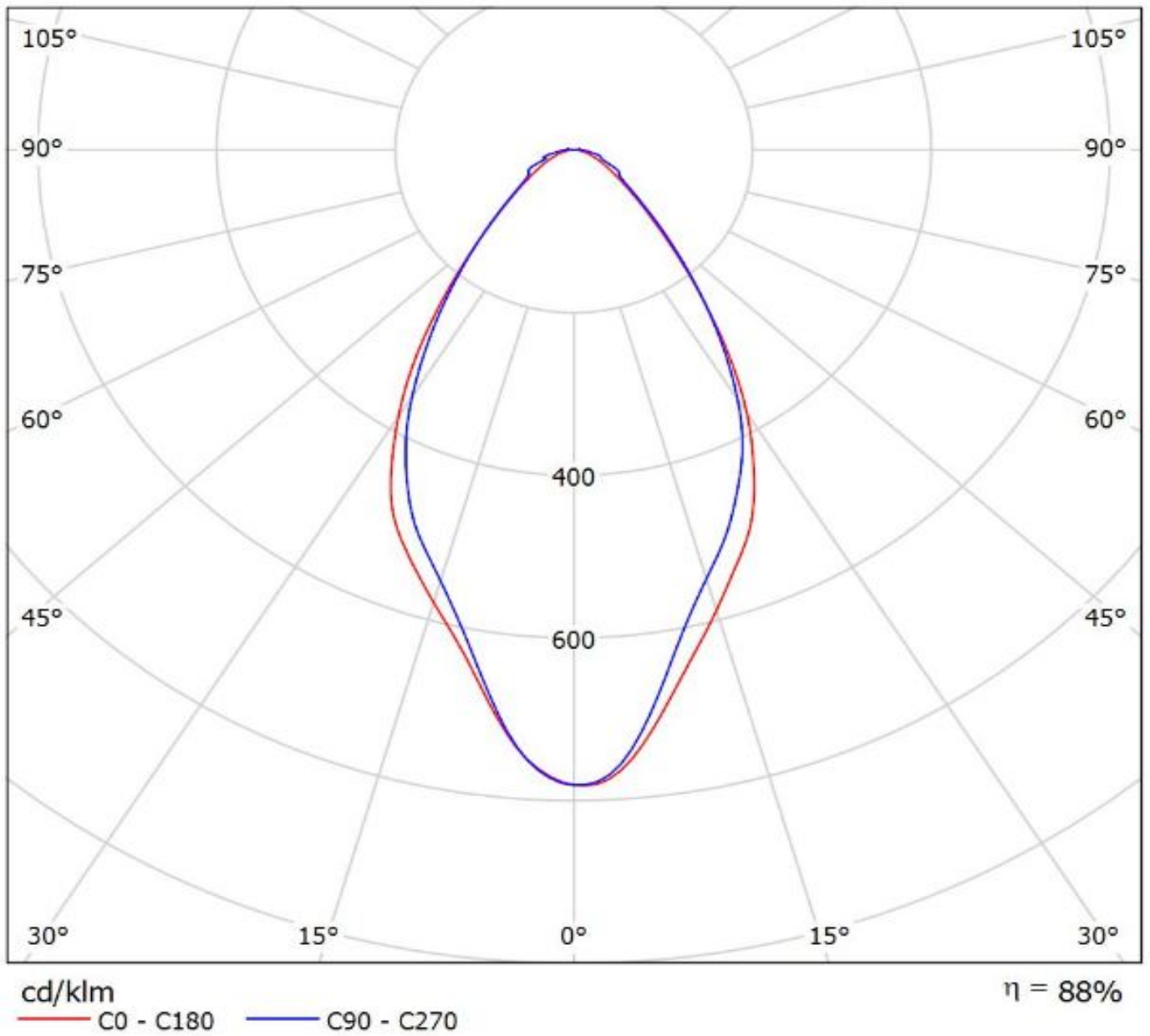

Luminaire: Ledil FS15786_FLORENCE-3R-IP-Z60_(Fortimo_LED_Line_1ft_2000lm_835_3R_HV2)
Lamps: 1 x Philips_Fortimo_LED_Line_1ft_2000lm_835_3R_HV2_(LG7030)_1226.7lm@250mA_P=7.54023W_I=0.250A

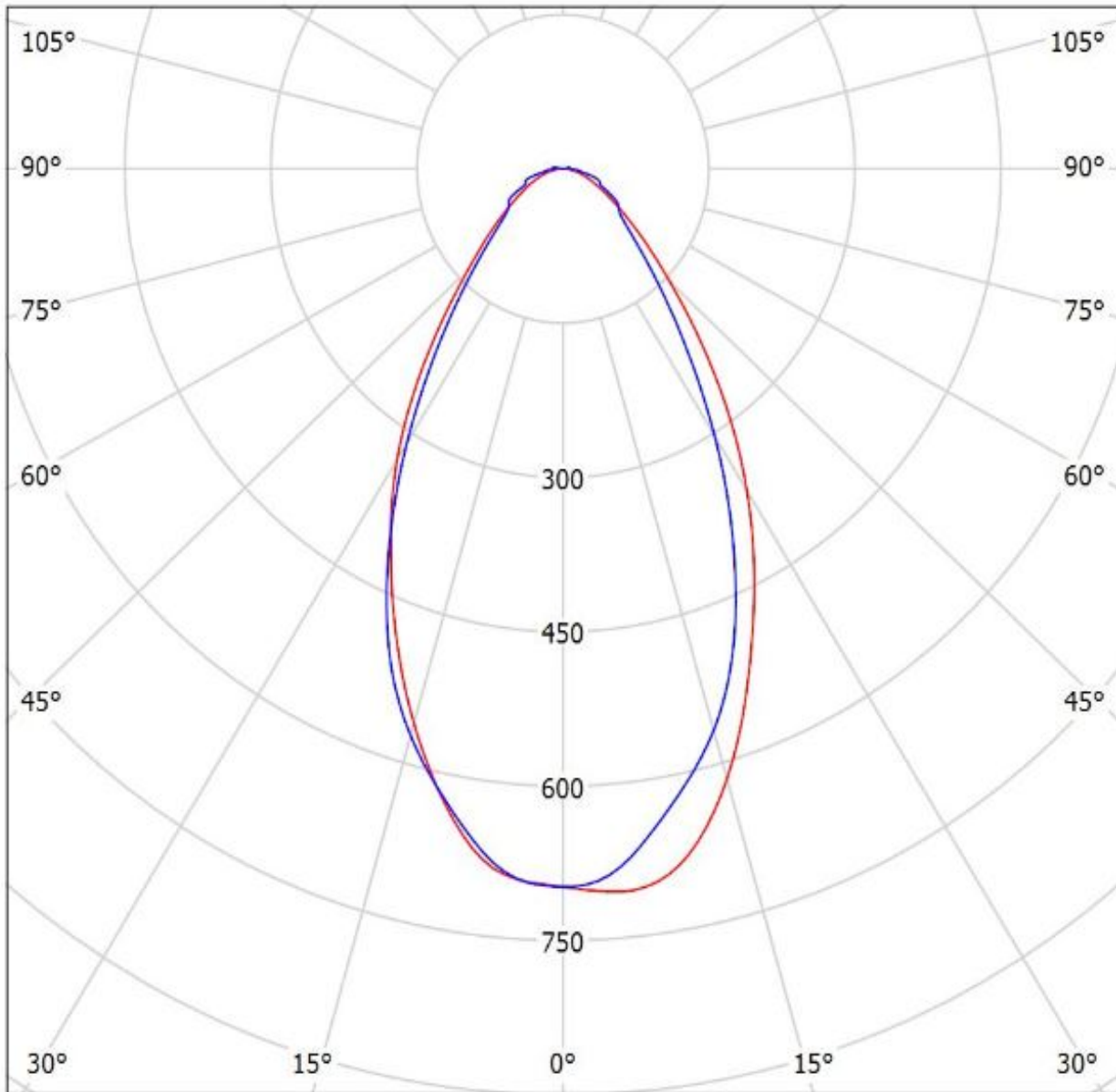

cd/klm

— C0 - C180 — C90 - C270

$\eta = 86\%$

Luminaire: LEDiL Oy FS15786_FLORENCE-3R-IP-Z60_(Fortimo_LED_Line_1ft_1100lm_840_3R_HV2)
Lamps: 1 x Fortimo_LED_Line_1ft_1100lm_840_3R_HV2_1035.97lm@250mA_P=7.91516W_I=0.25A

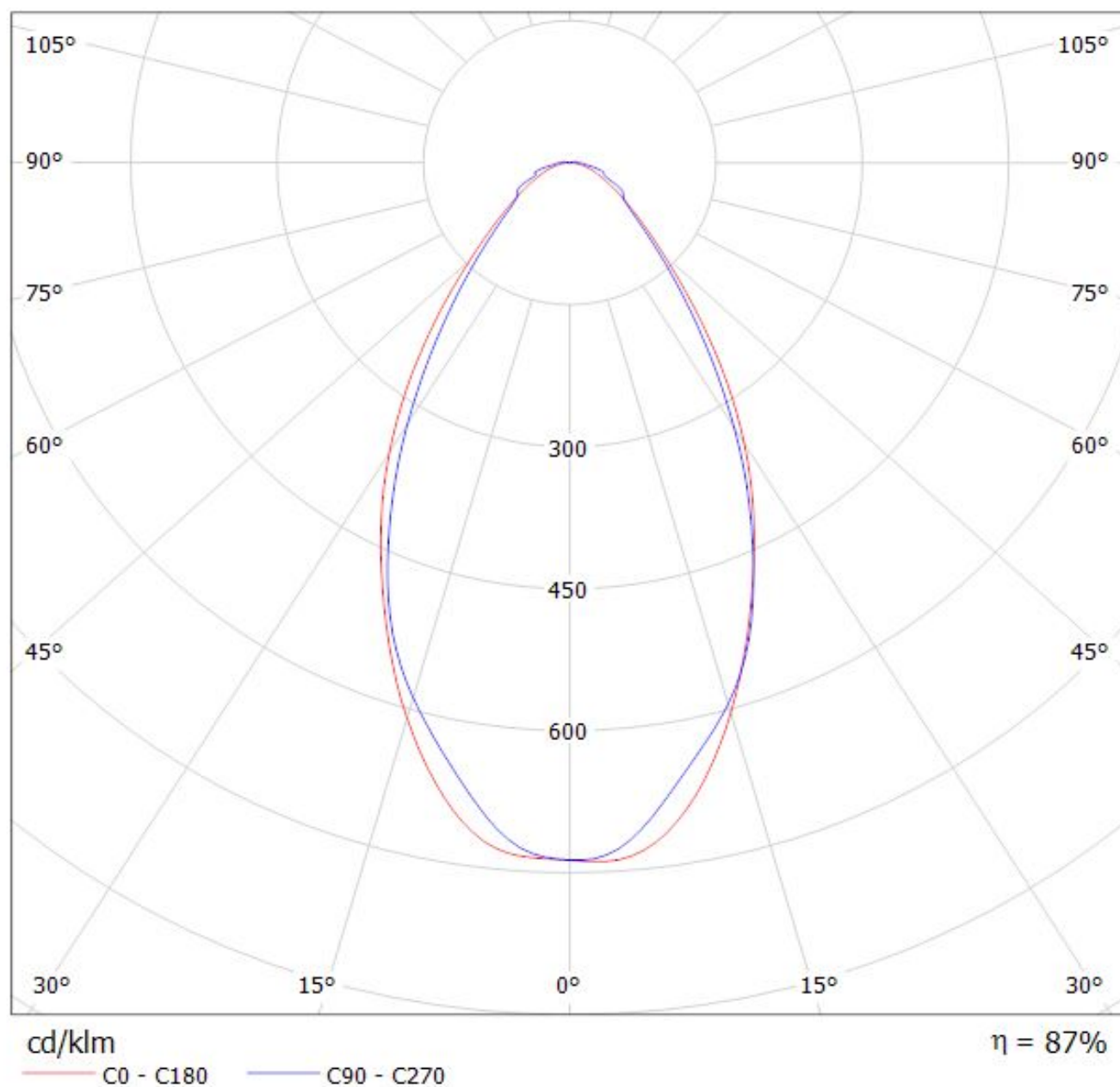

Luminaire: LEDiL Oy FS15786_FLORENCE-3R-IP-Z60_(Philips_Fortimo_LED_Line_1ft_650lm_840_3R_LV3)
Lamps: 1 x Philips_Fortimo_LED_Line_1ft_650lm_840_3R_LV3_1122.62lm@250mA_P=8.18145W_I=0.250A

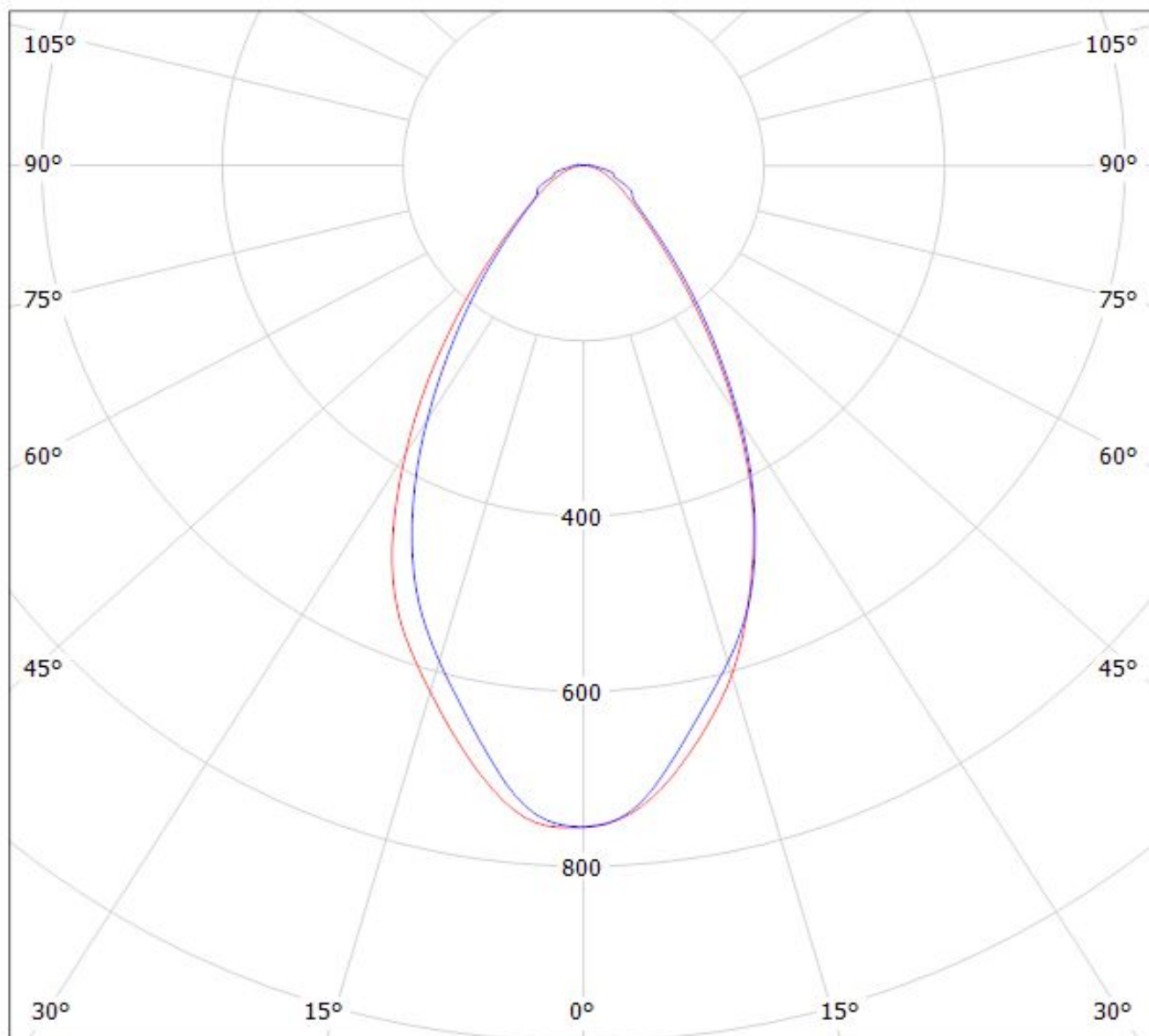

cd/klm

$\eta = 86\%$

— C0 - C180

— C90 - C270

Luminaire: Ledil Oy FS15786_FLORENCE-3R-IP-Z60_(Z8Y22)_SIMULATED
Lamps: 1 x Seoul Z8Y22

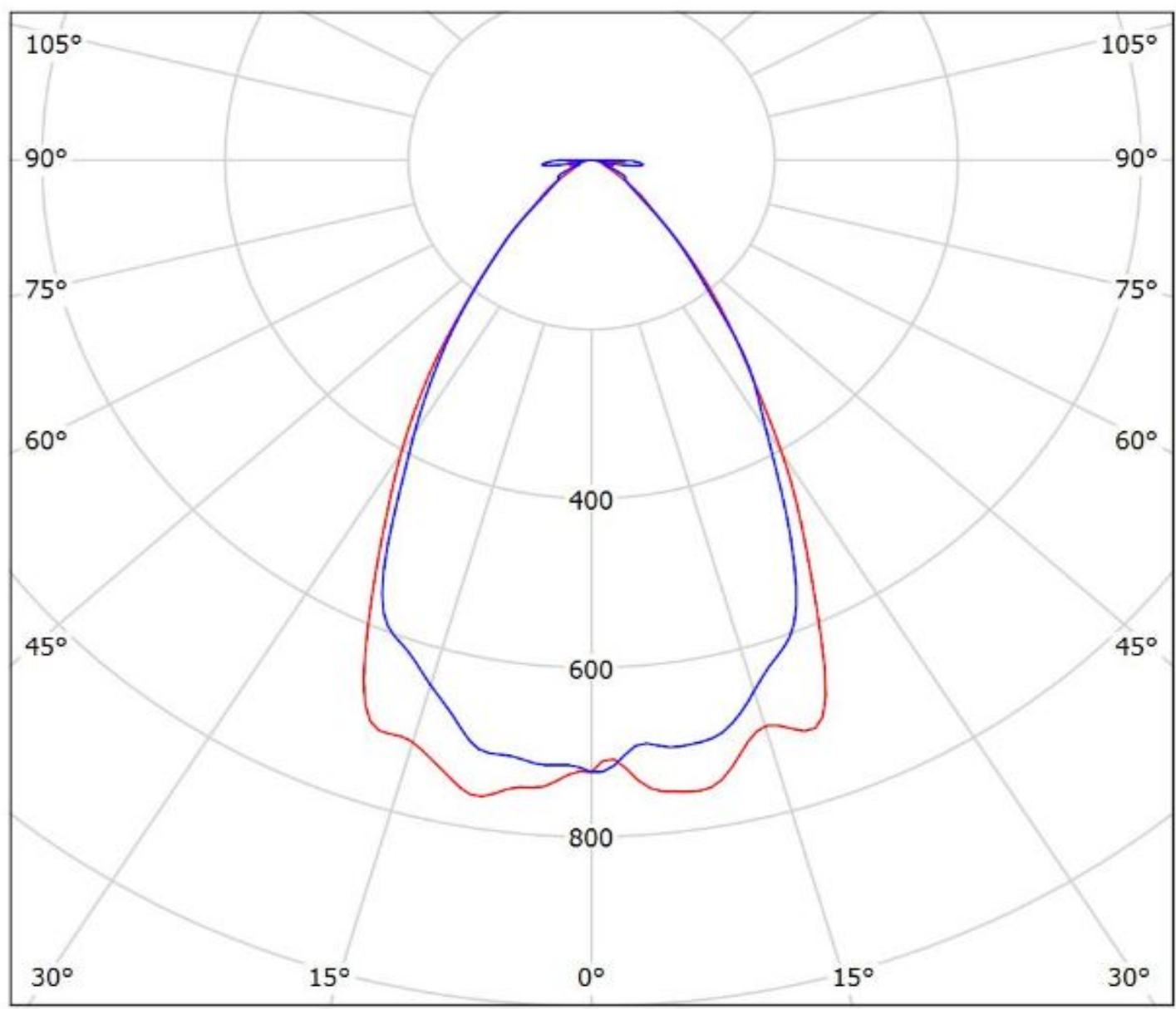

cd/klm
— C0 - C180 — C90 - C270

$\eta = 93\%$

Luminaire: Ledil Oy FS15786_FLORENCE-3R-IP-Z60_(Z8Y22P)_SIMULATED
Lamps: 1 x Seoul Z8Y22P

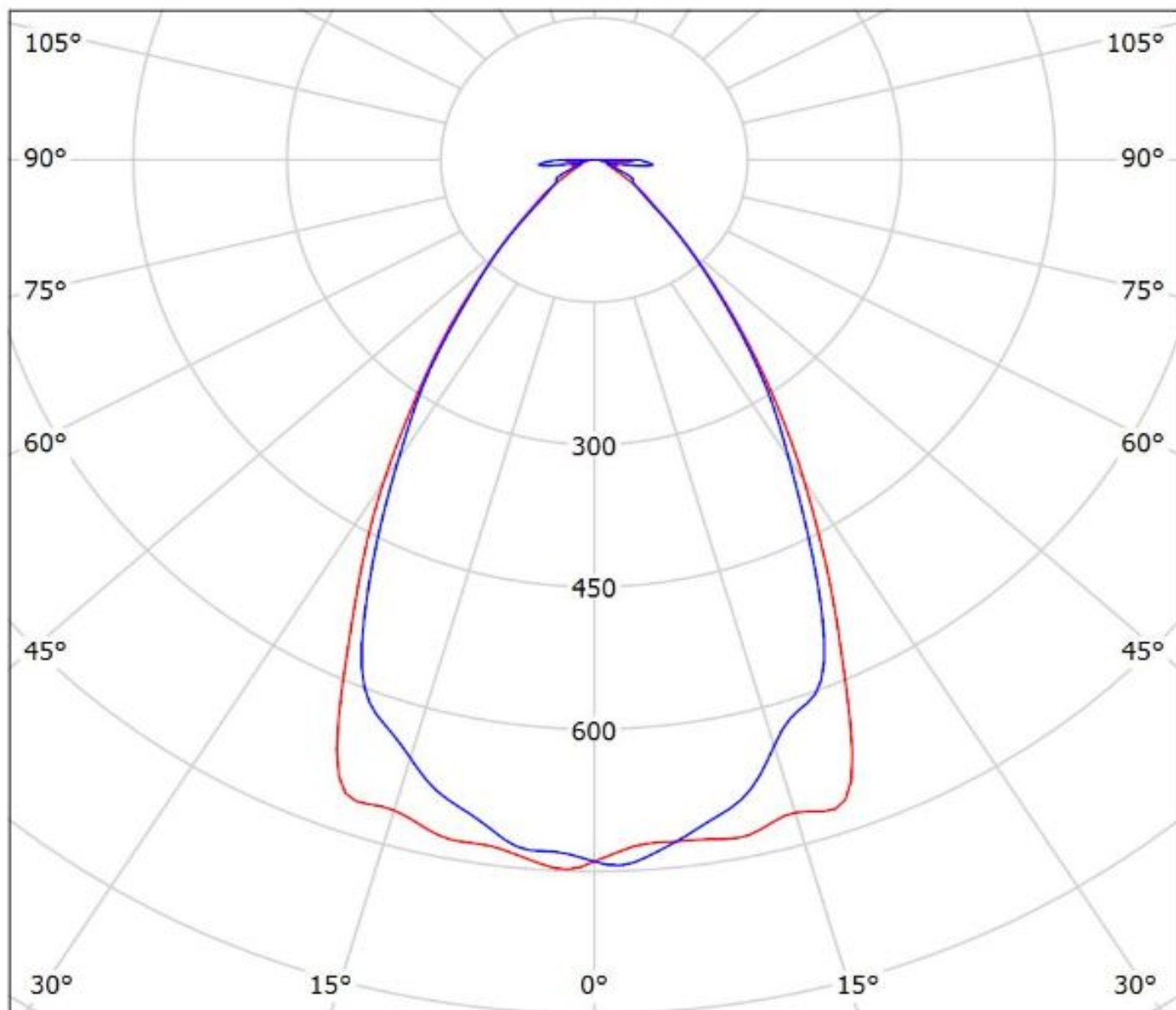

cd/klm
— C0 - C180 — C90 - C270

$\eta = 93\%$

NOTE: The typical divergence will be changed by different color, chip size and chip position tolerance. The typical total divergence is the full angle measured where the luminous intensity is half of the peak value.