

DETAILS

Product Number	FS15847_FLORENCE-3R-IP-O
Family	Florence
Type	Assembly
Color	clear
Diameter	321 + 79 mm
Height	9,4 mm
Style	rectang
Optic Material	PC
Holder Material	
Fastening	
Status	production ready
ROHS Compliant	Yes
Date Updated	29/09/2017

OPTICAL PROPERTIES

LED	Viewing	Light	Effi-		Connector
	Angle	Beam	ciency	cd/lm	
LUXEON 5050	sim: 85+54		sim: 88 %	sim: 0.590	-
PLG2-BAR-1100-xxx-280x55-DC	84+40 deg		86 %	0.680	-
Duris S10	sim: 84+70		sim: 86 %	sim: 0.490	-
Duris S8	sim: 84+51		sim: 88 %	sim: 0.620	-
Fortimo LED Line 1ft 1100lm xx0 3R xV2/83/68	83+68 deg		88 %	0.720	-
Fortimo LED Line 1ft 2000lm 8xx 3R HV278	+38 deg		87 %	0.750	-
Fortimo LED Line 1ft 650lm 8x0 3R xV2/86/39	86+39 deg		87 %	0.710	-
LM302B	sim: 82+28		sim: 86 %	sim: 0.920	-
LM561B Plus	sim: 82+28		sim: 86 %	sim: 0.930	-
Z8Y22	sim: 90+40		sim: 92 %	sim: 0.700	-
Z8Y22P	sim: 91+40		sim: 91 %	sim: 0.680	-
SEOUL 3528	sim: 87+31		sim: 88 %	sim: 0.840	-



H G F E D C B A

4

3

2

1

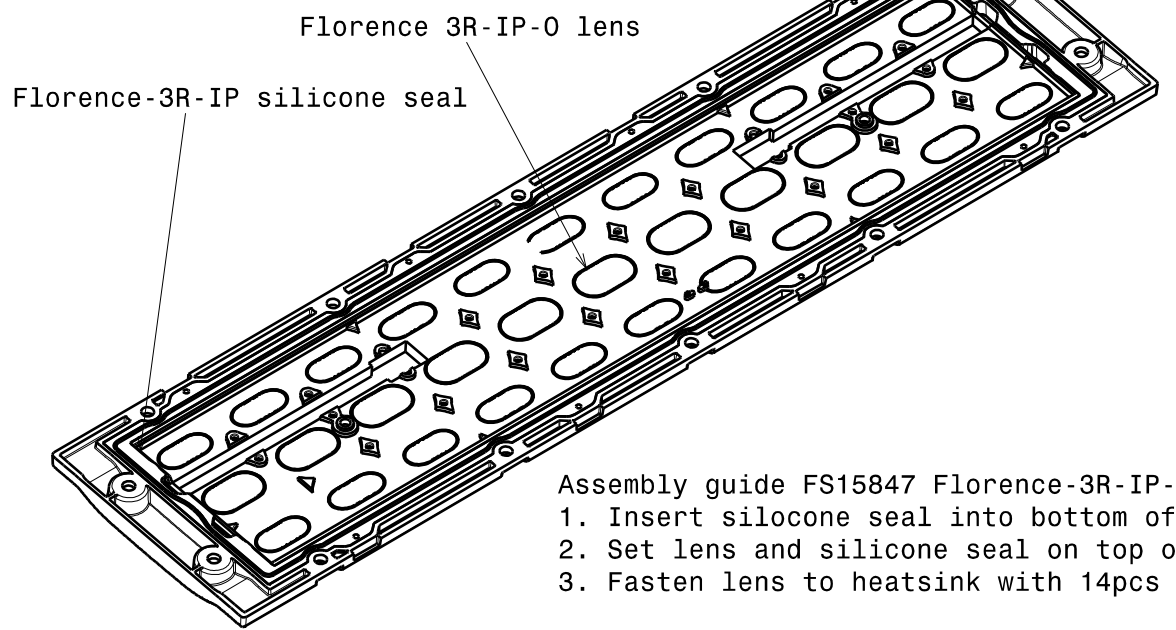
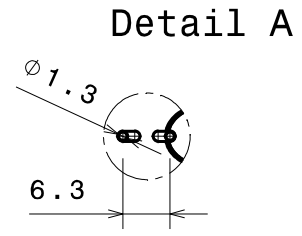
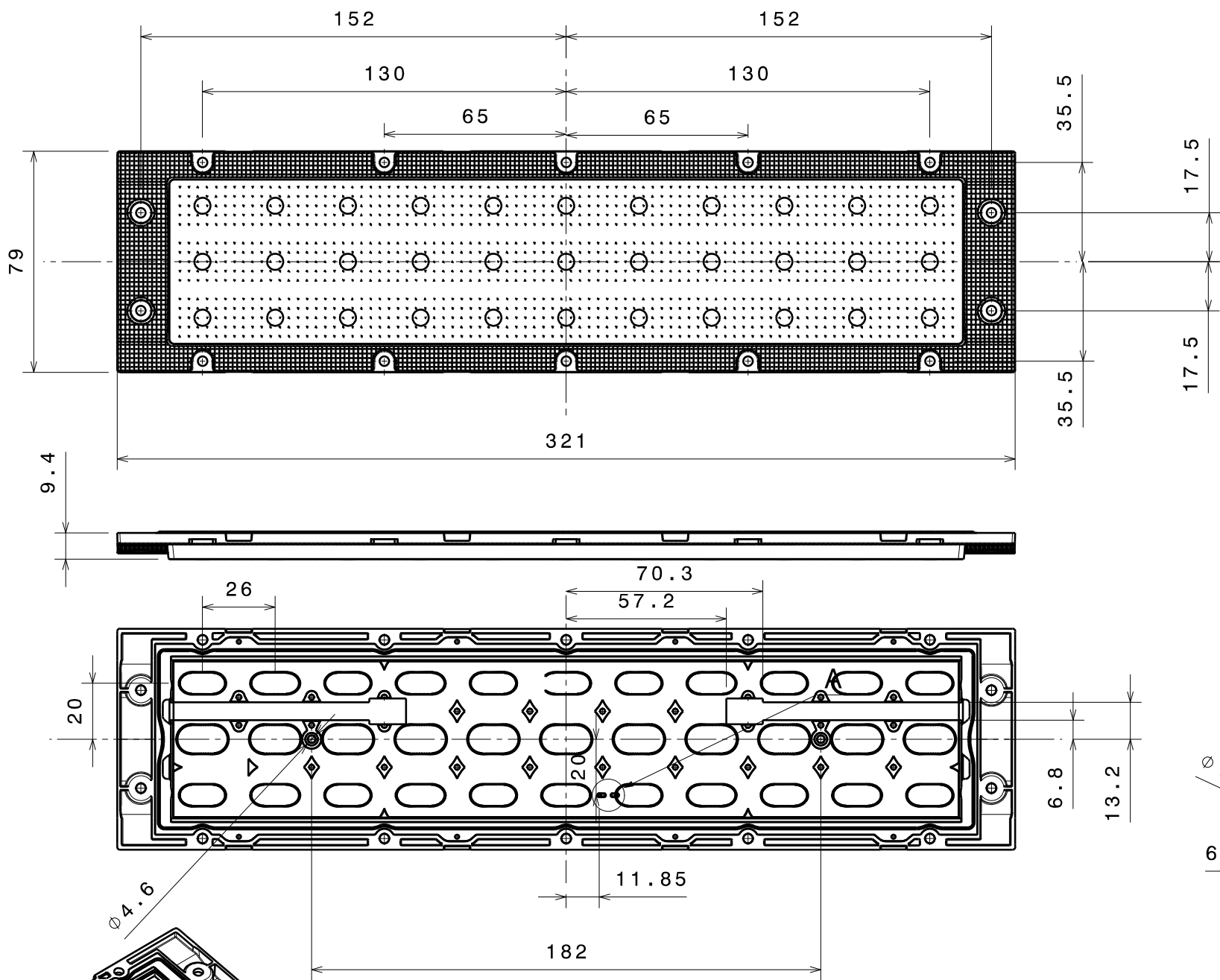

Assembly guide FS15847 Florence-3R-IP-0:
 1. Insert silicone seal into bottom of Florence-3R-IP-0 lens
 2. Set lens and silicone seal on top of PCB
 3. Fasten lens to heatsink with 14pcs of M3 screws

Screw type DIN 7985 M3, Max torque 0.6Nm

INDEX	PART NO	DESCRIPTION	MATERIAL	COLOUR
1	F15625	FLORENCE-3R-IP-Seal	Silicone	
2	F15675	FLORENCE-3R-IP-0	PC	

Tolerances if not otherwise shown
 According to DIN ISO 2768-1
 Linear measures:
 Up to 30mm class M, otherwise class C.
 According to DIN ISO 2768-2
 Form and position: class L

THIRD ANGLE PROJECTION:

This drawing is the property of LEDiL Oy. It may not be reproduced, copied or communicated without a written agreement with LEDiL Oy.

LEDiL Oy Salorankatu 10 FIN 24240 SALO Finland	DRAWING TITLE	
	FS15827_Florence-3R-IP-0_Mechanical_drawing	
SIZE	PART NUMBER	
A3	FS15827	
SCALE	1:1	WEIGHT
		g
SHEET		1/1

H G F E D C B A

Luminaire: Ledil Oy FS15847_FLORENCE-3R-IP-O_(Luxeon_5050)_SIMULATED
Lamps: 4 x Lumileds Luxeon 5050 without any rotation

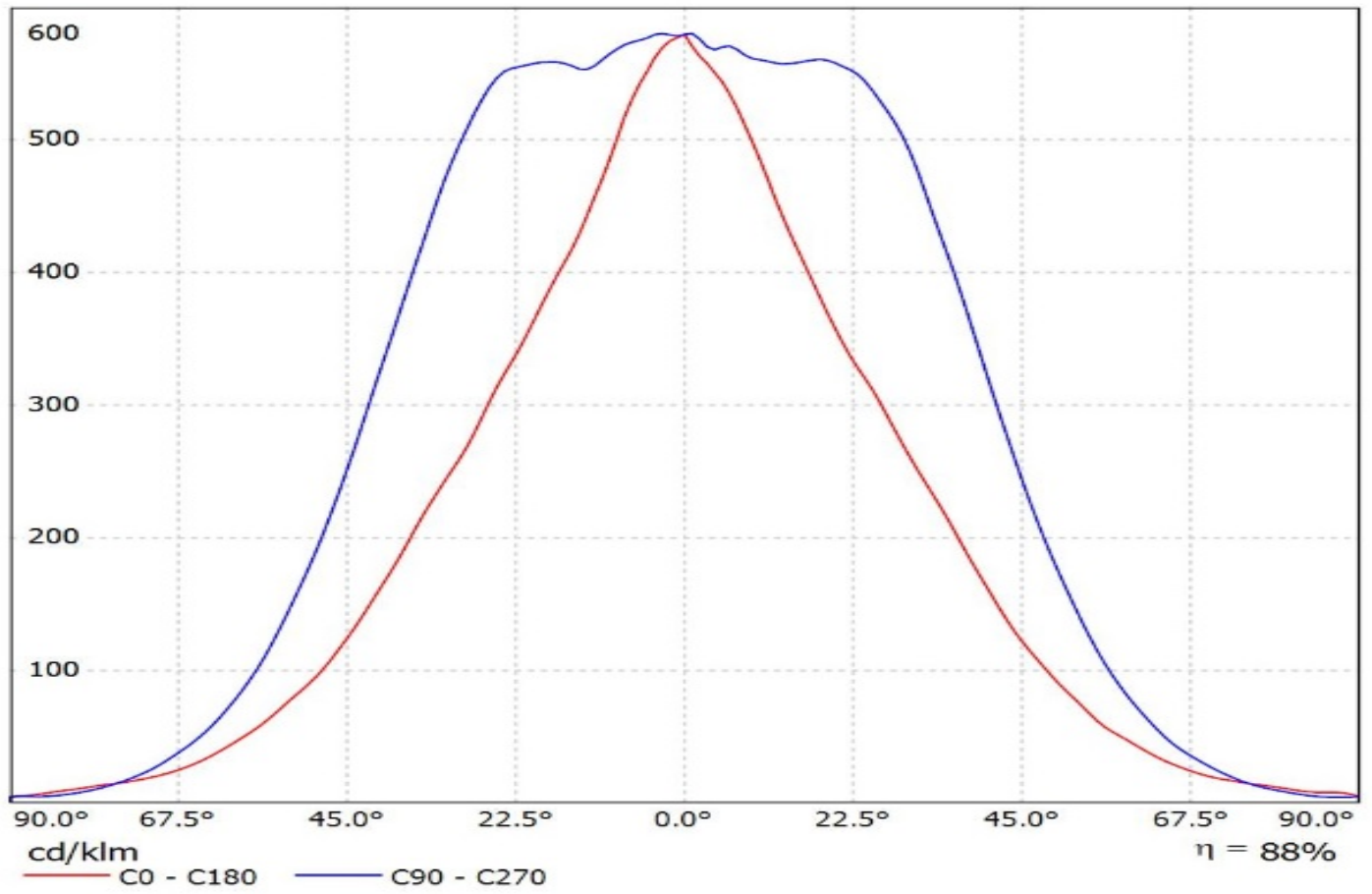

Luminaire: Ledil FS15847_FLORENCE-3R-IP-O_(LG-6030)_Cav1
Lamps: 1 x LG-6030_(LEWMS68T80HZ)_1073.53lm@250mA_cct=5000K_P=7.9555W_I=0.25A

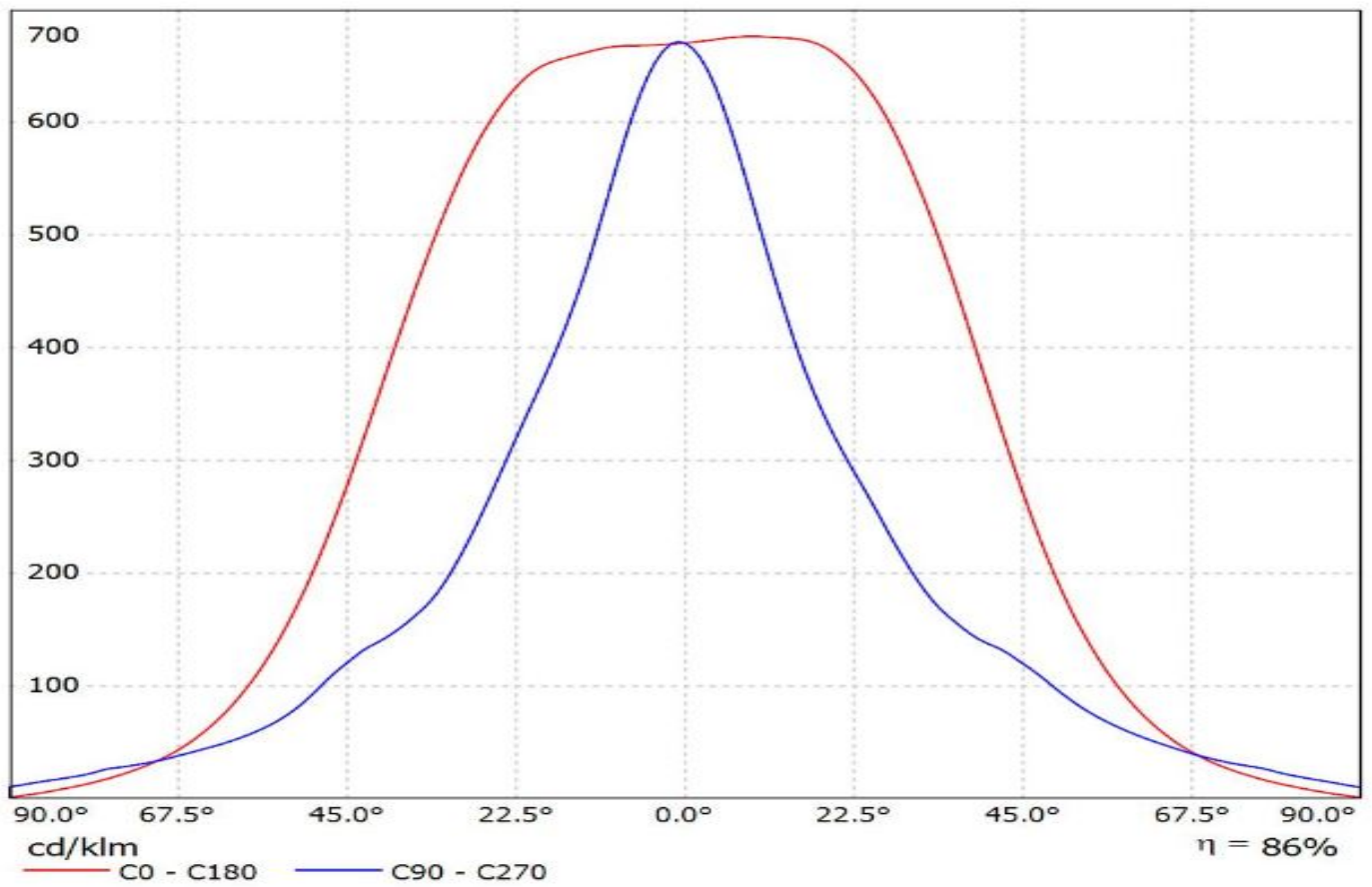

Luminaire: Ledil Oy FS15847_FLORENCE-3R-IP-O_(Duris_S10)_SIMULATED
Lamps: 4 x Osram_Duris S10 with 90 degree rotation to next led

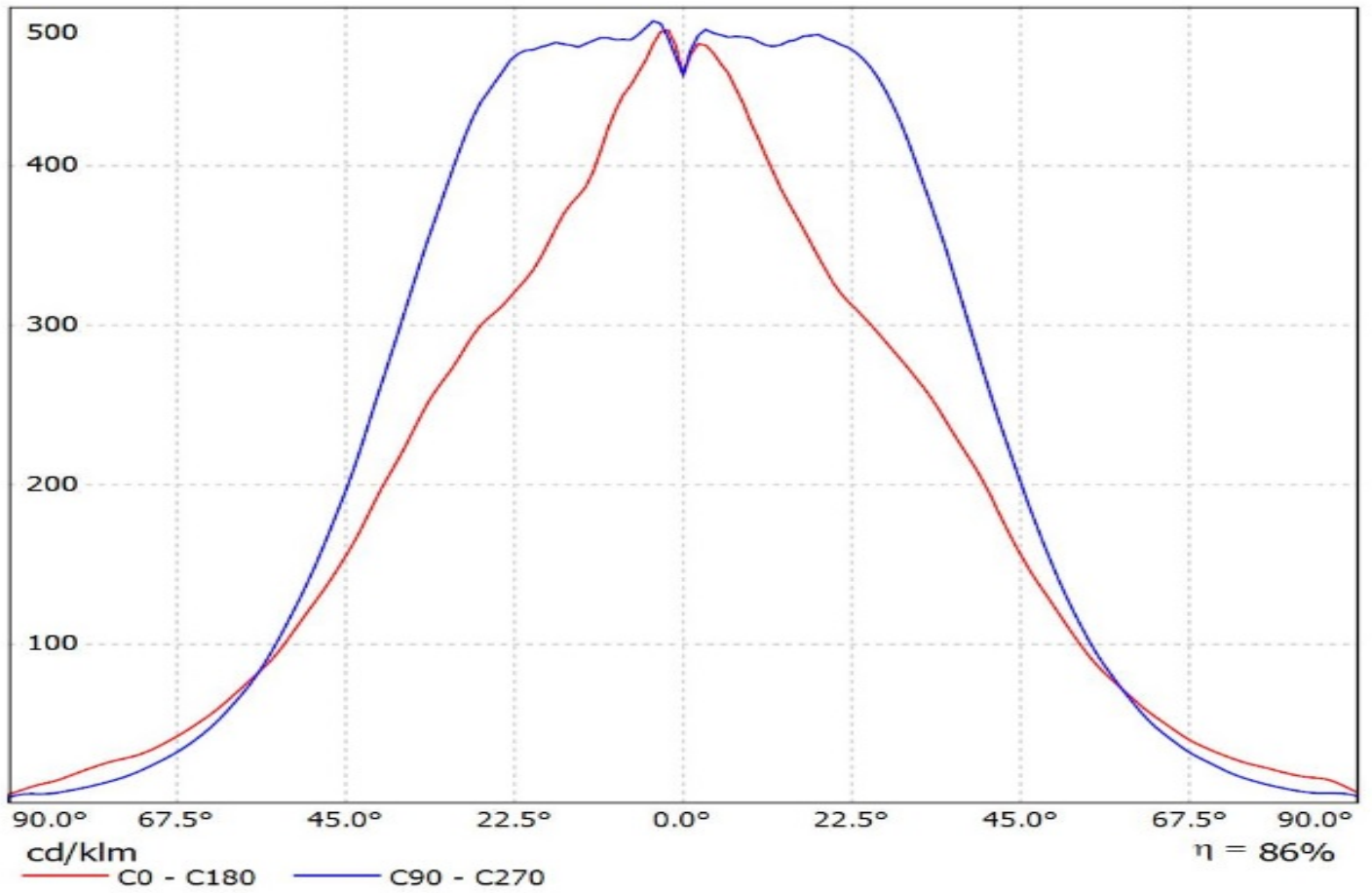

Luminaire: Ledil Oy FS15847_FLORENCE-3R-IP-O_(Duris_S8)_SIMULATED
Lamps: 1 x Osram Duris S8 - GW P9LM31.EM

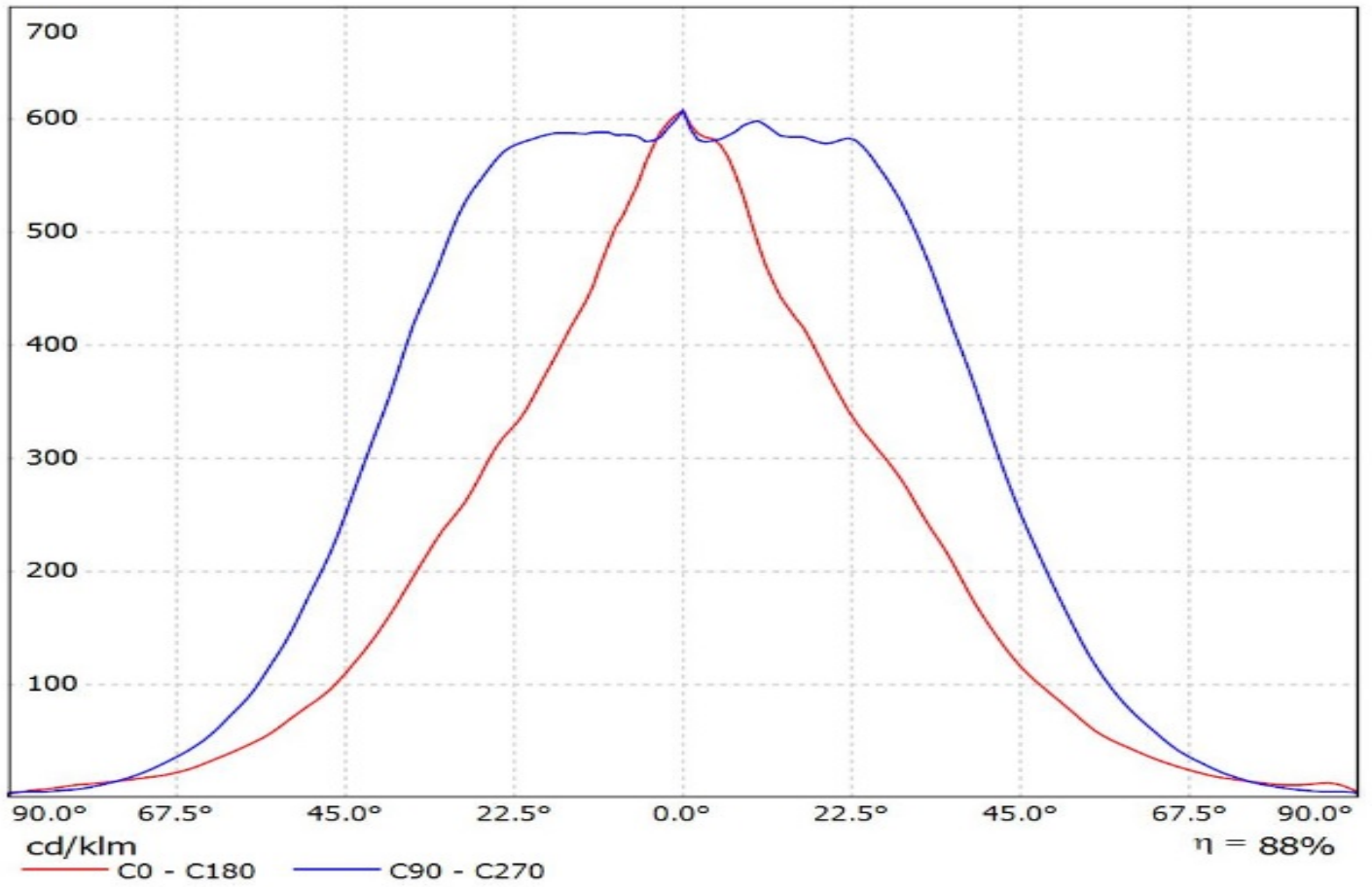

Luminaire: LEDiL Oy FS15847_FLORENCE-3R-IP-O_(Fortimo_LED_Line_1ft_1100lm_840_3R_HV2)
Lamps: 1 x Fortimo_LED_Line_1ft_1100lm_840_3R_HV2_1035.97lm@250mA_P=7.91516W_I=0.25A

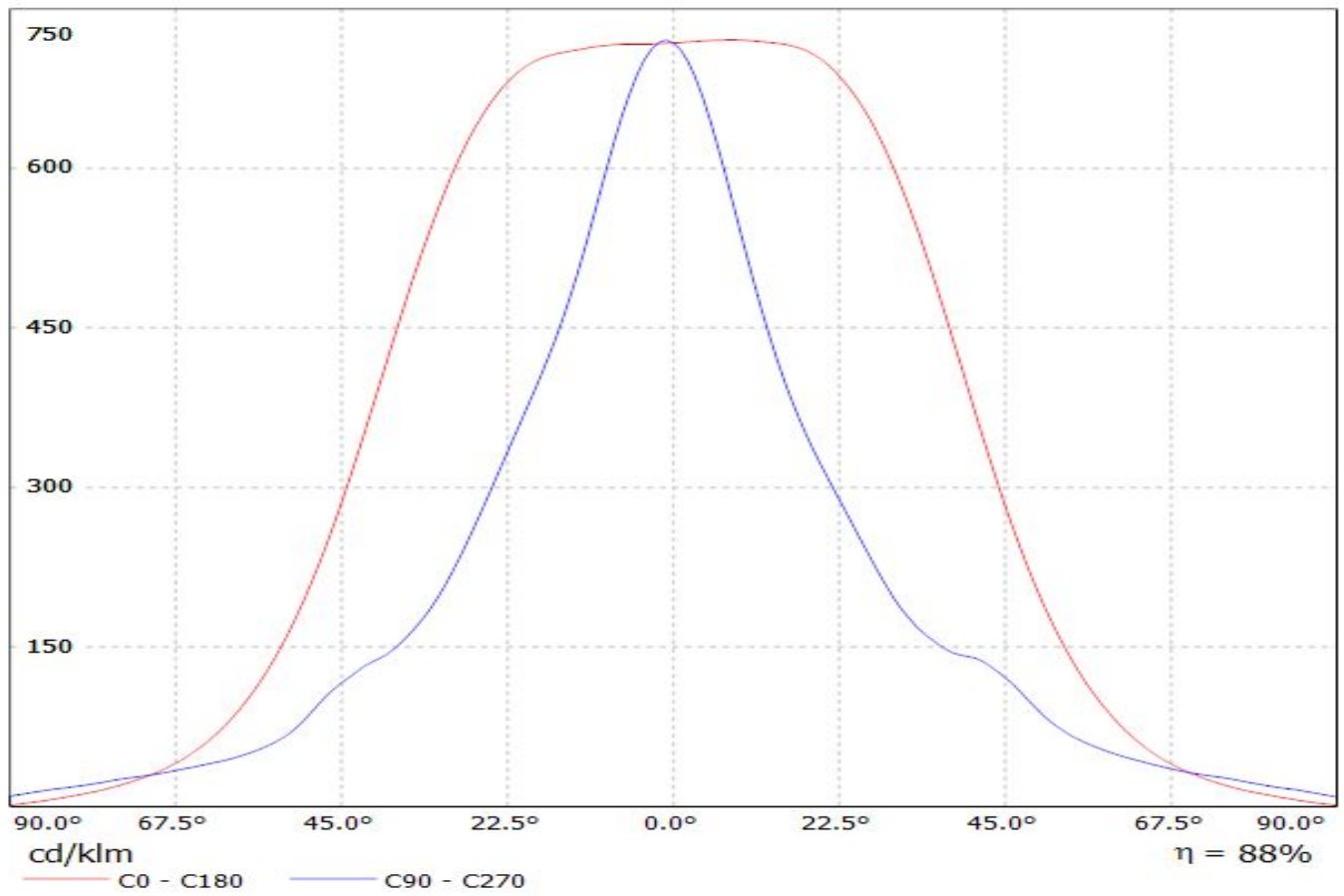

Luminaire: Ledil FS15847_FLORENCE-3R-IP-O (Fortimo_LED_Line_1ft_2000lm_835_3R_HV2)

Lamps: 1 x Philips_Fortimo_LED_Line_1ft_2000lm_835_3R_HV2 (LG7030)_1226.7lm@250mA_P=7.54023W_I=0.250A

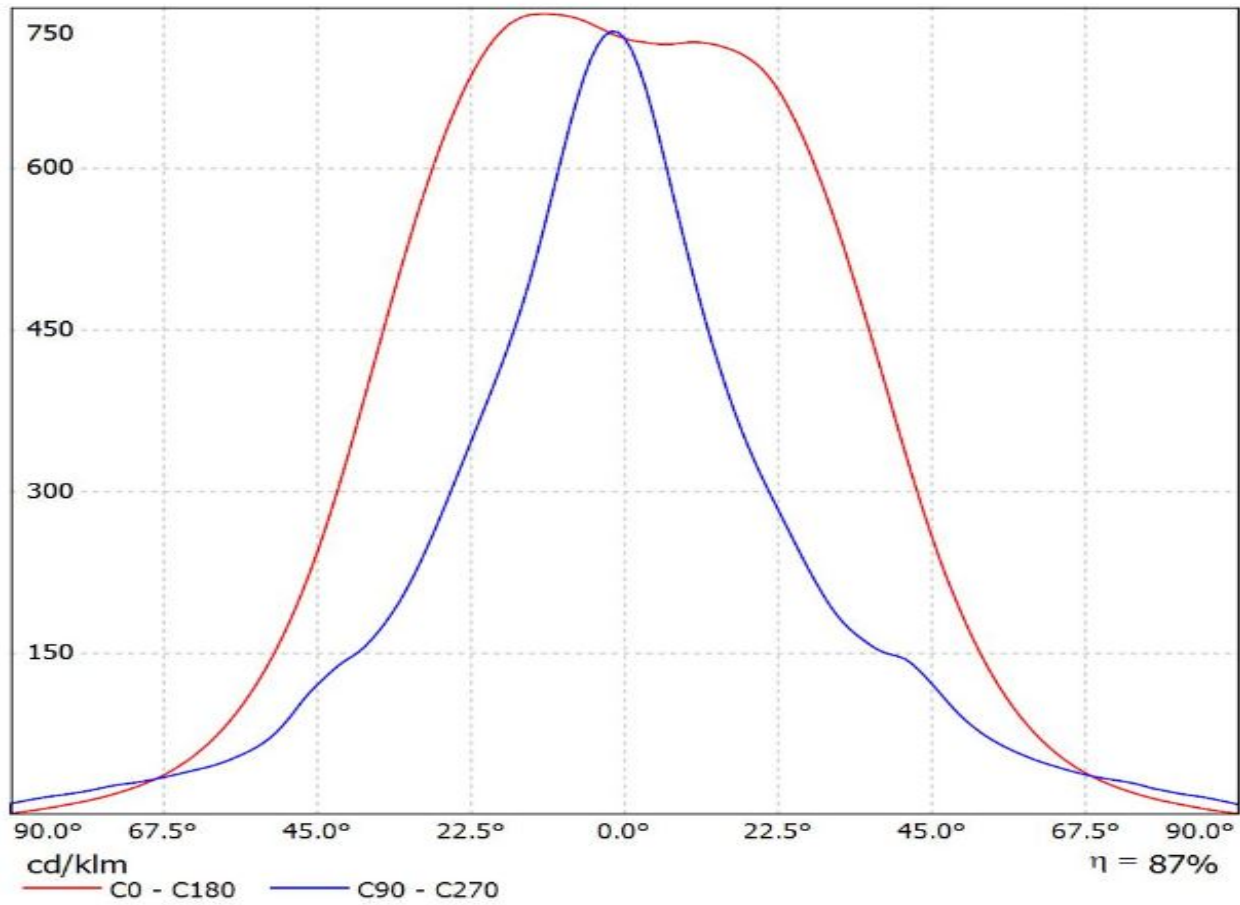

Luminaire: LEDiL Oy FS15847_FLORENCE-3R-IP-O (Philips_Fortimo_LED_Line_1ft_650lm_840_3R_LV3)
Lamps: 1 x Philips_Fortimo_LED_Line_1ft_650lm_840_3R_LV3_1122.62lm@250mA_P=8.18145W_I=0.250A

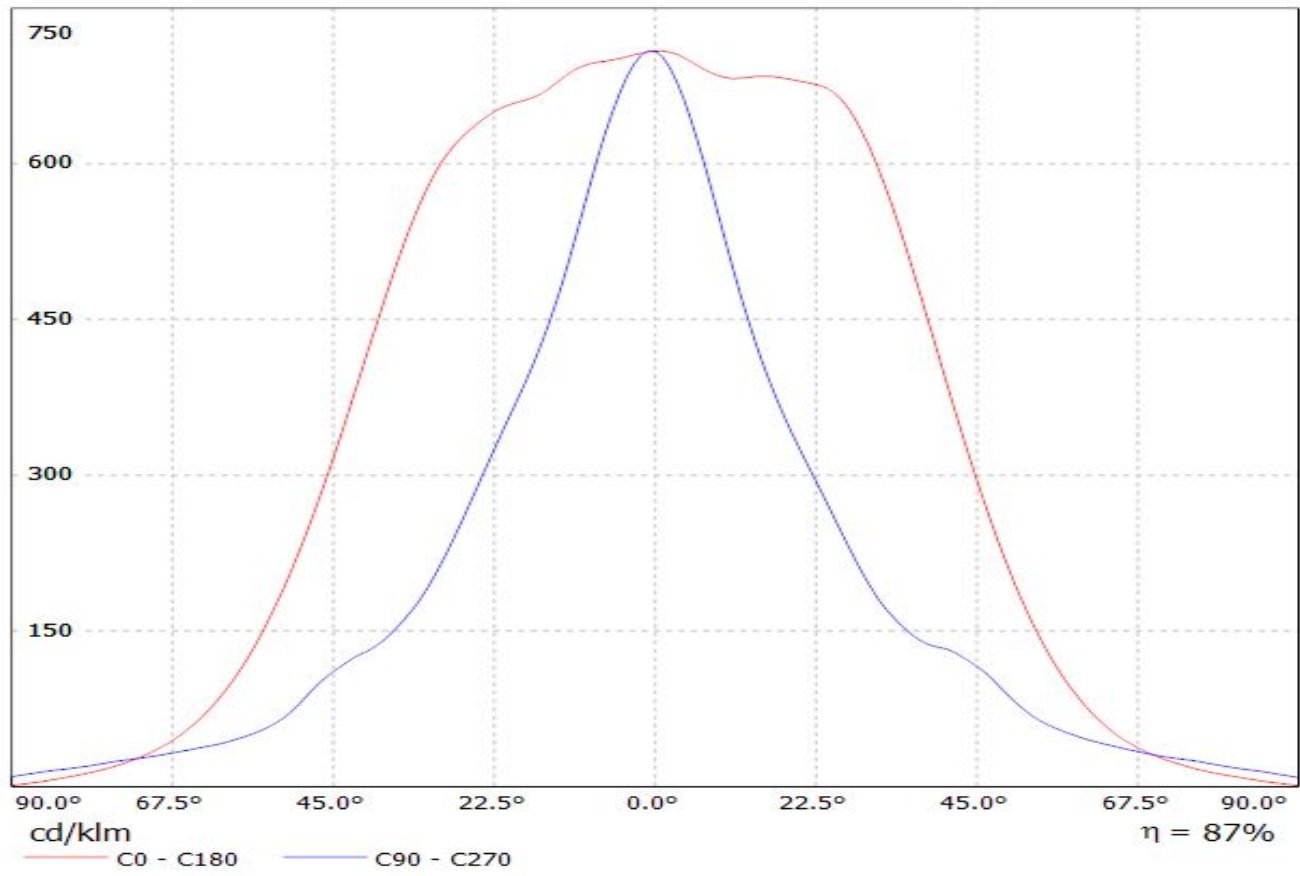

Luminaire: Ledil Oy FS15847_FLORENCE-3R-IP-O_(LM302B)_SIMULATED
Lamps: 4 x Samsung LM302B

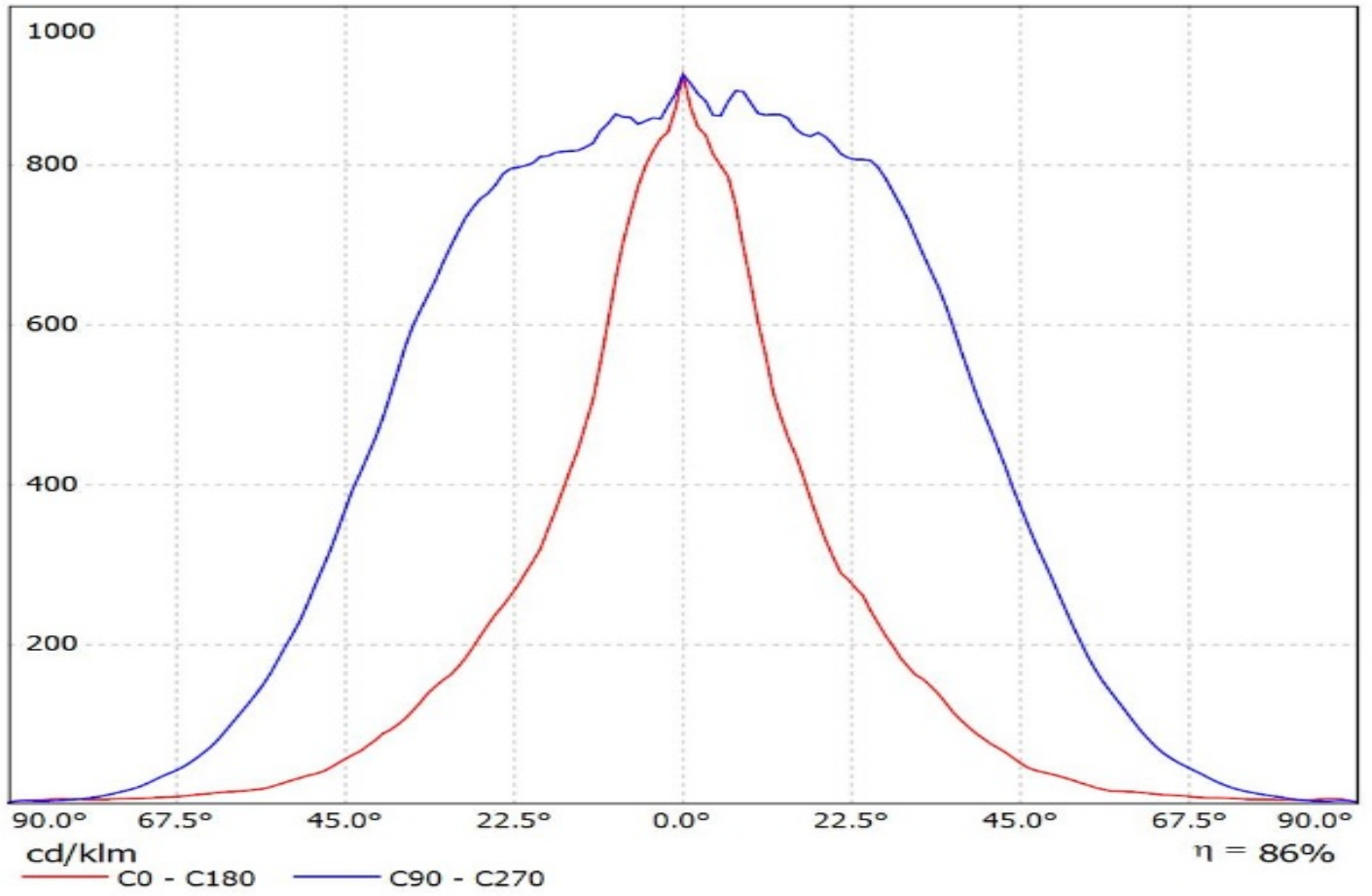

Luminaire: Ledil Oy FS15847_FLORENCE-3R-IP-O_(LM561B_PLUS)_SIMULATED
Lamps: 4 x Samsung LM561B PLUS

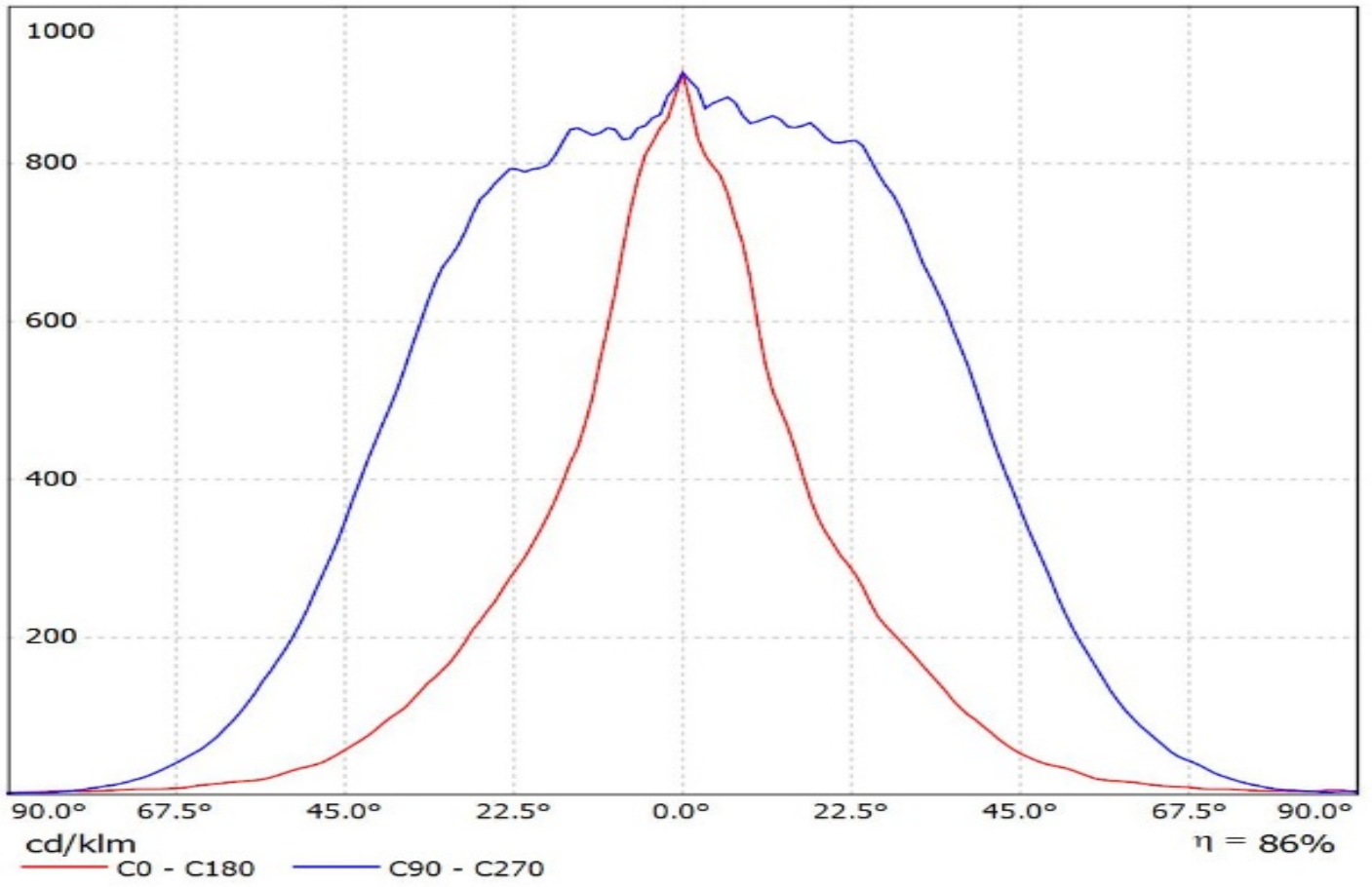

Luminaire: Ledil Oy FS15847_FLORENCE-3R-IP-O_(Z8Y22)_SIMULATED
Lamps: 1 x Seoul Z8Y22

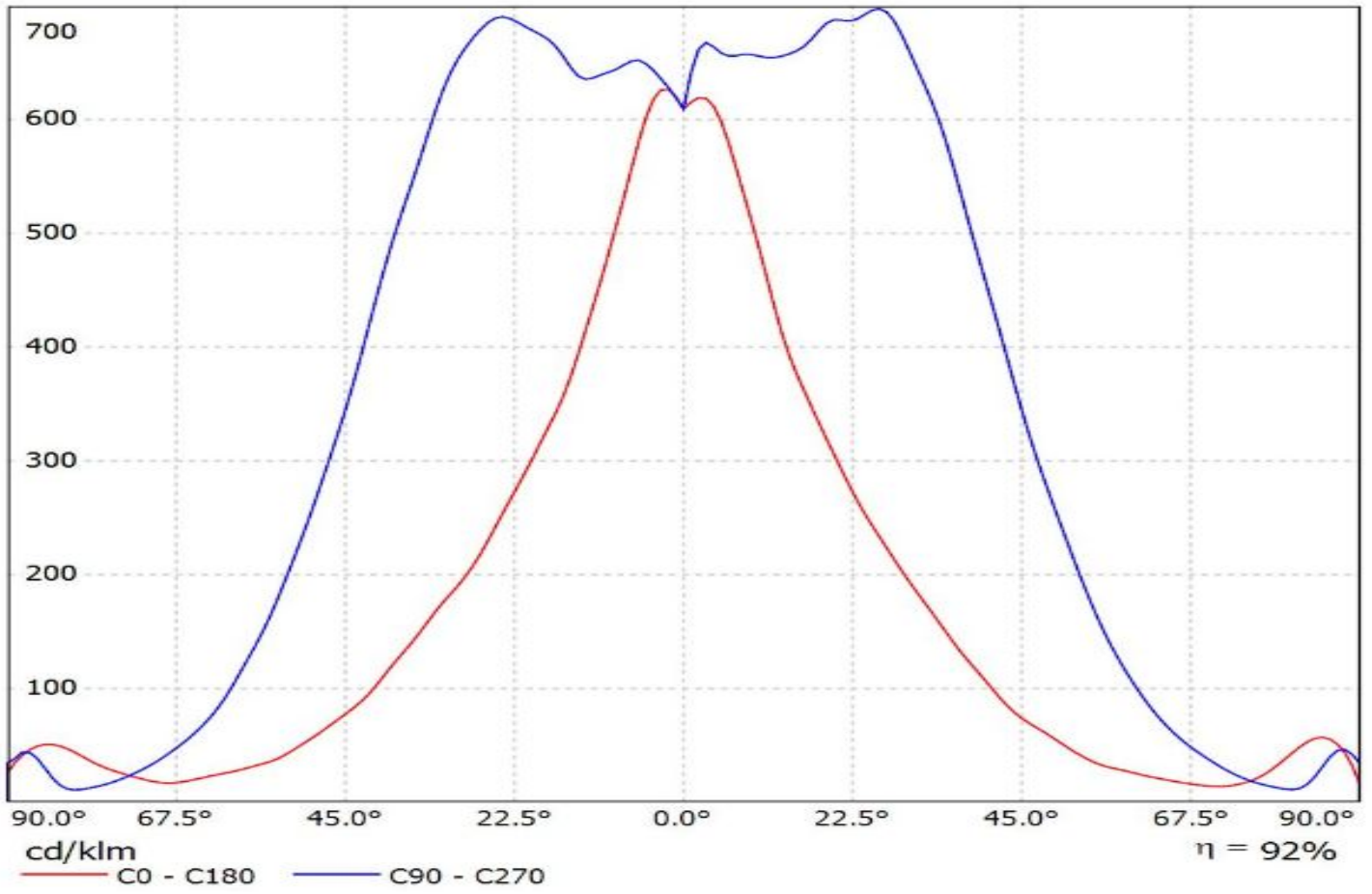

Luminaire: Ledil Oy FS15847_FLORENCE-3R-IP-O_(Z8Y22P)_SIMULATED
Lamps: 1 x Seoul Z8Y22P

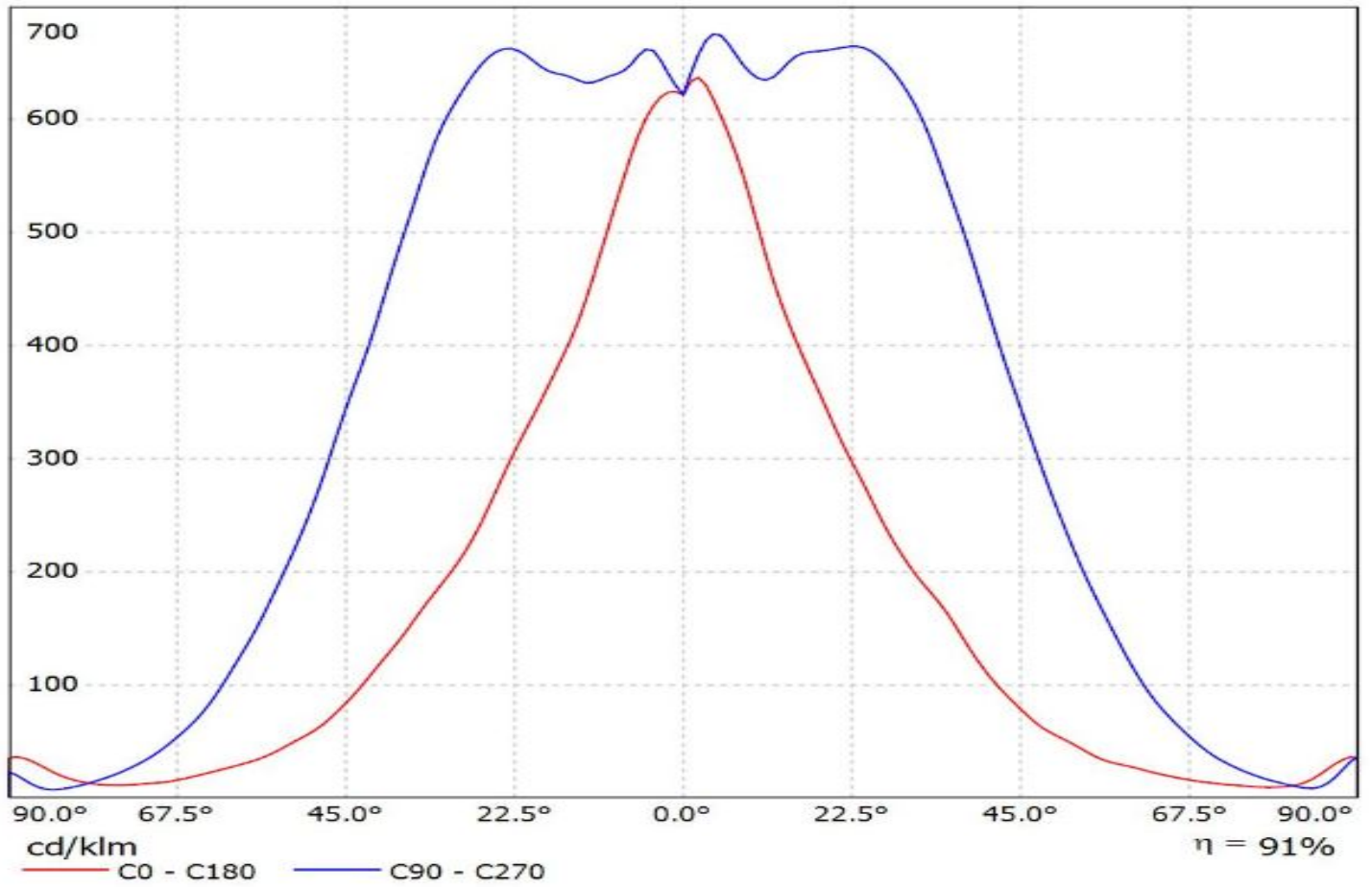

Luminaire: Ledil Oy FS15847_FLORENCE-3R-IP-O_(SEOUL_3528_STW8A12D-E2)_SIMULATED
Lamps: 1 x Seoul 3528 STW8A12D-E2 - CCT: 4000 K

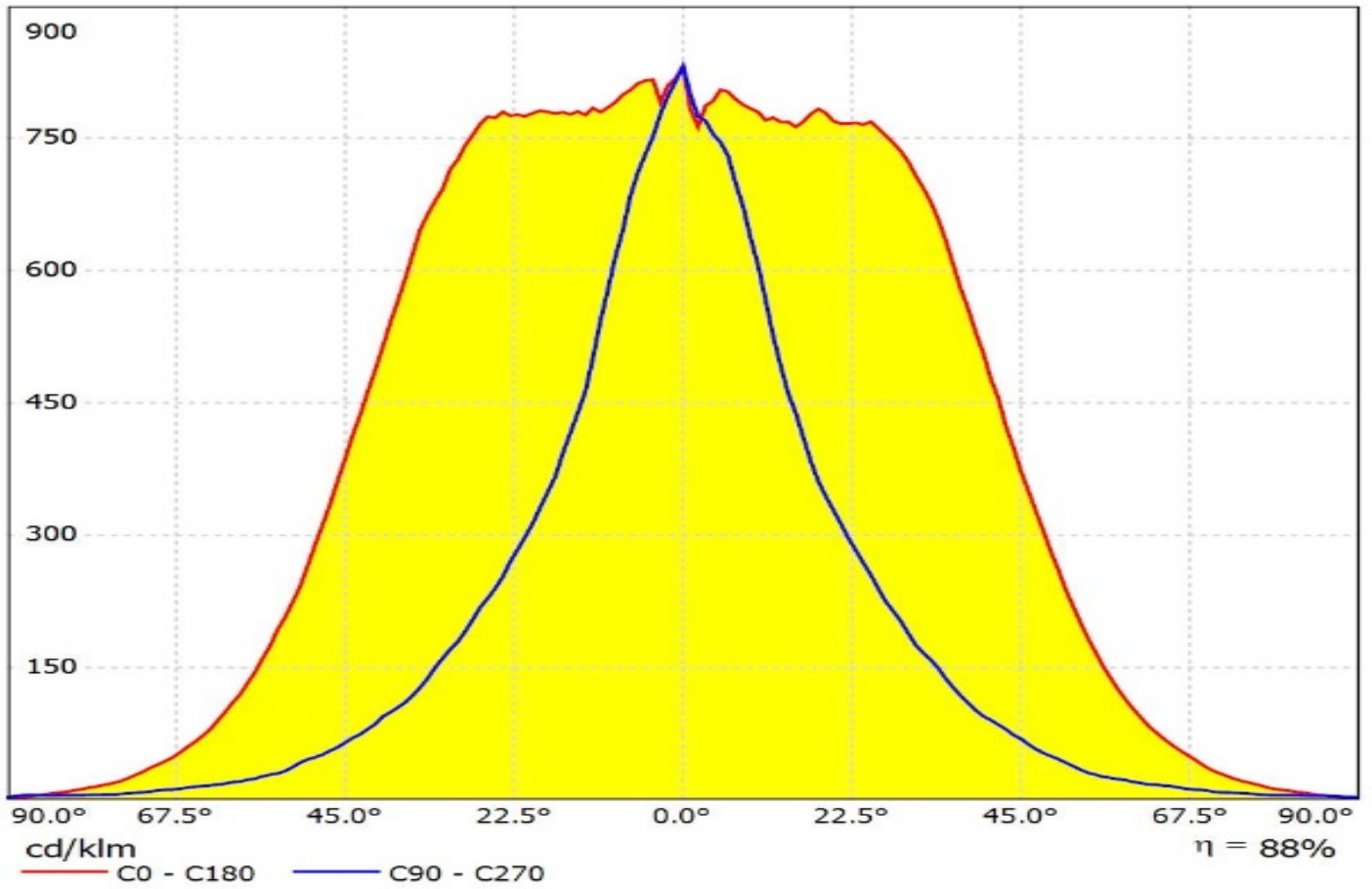

Luminaire: Ledil Oy FS15847_FLORENCE-3R-IP-O_(Luxeon_5050)_SIMULATED
Lamps: 4 x Lumileds Luxeon 5050 without any rotation

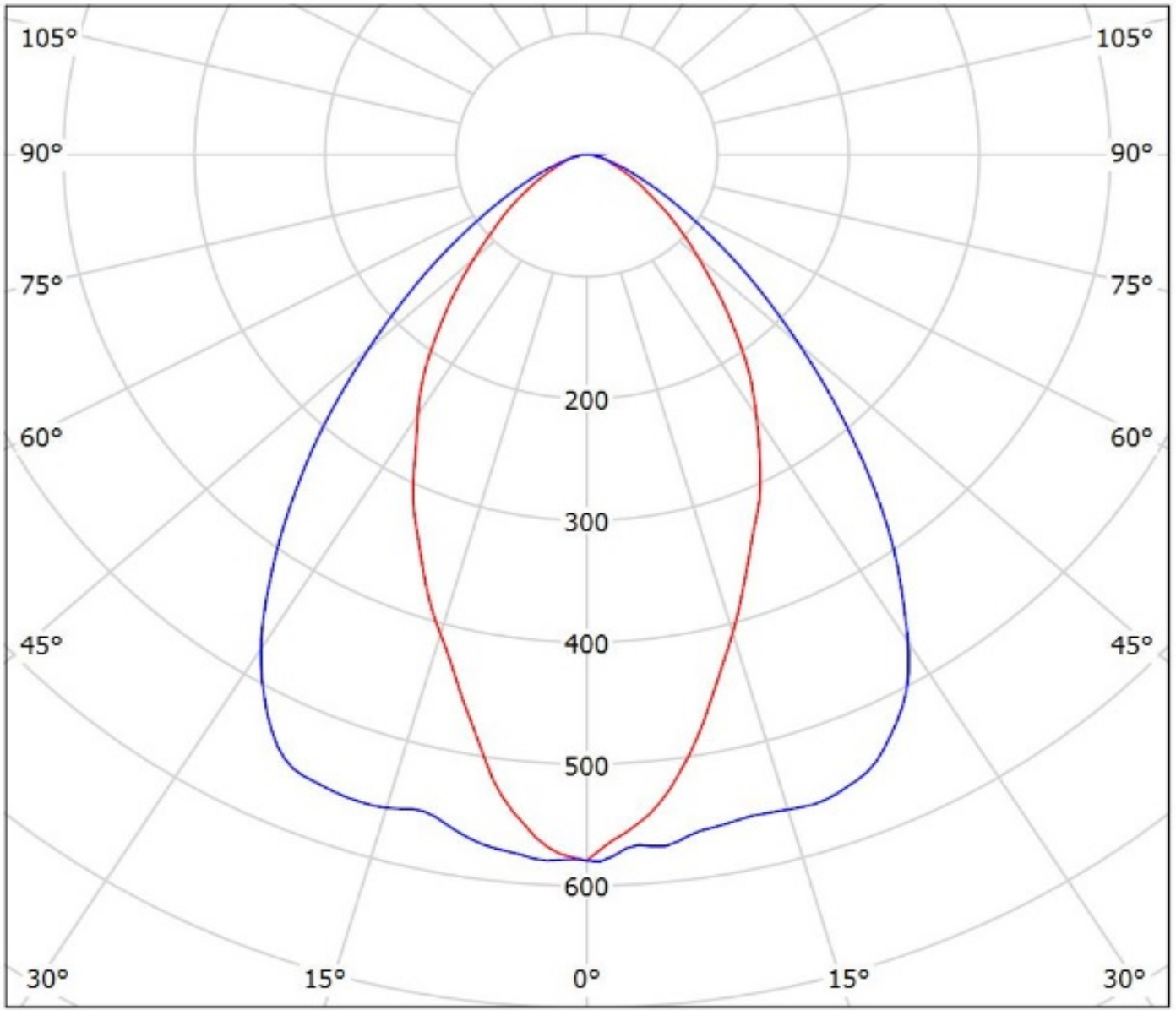

cd/klm
— C0 - C180 — C90 - C270

$\eta = 88\%$

Luminaire: Ledil FS15847_FLORENCE-3R-IP-O_(LG-6030)_Cav1

Lamps: 1 x LG-6030_(LEWMS68T80HZ)_1073.53lm@250mA_cct=5000K_P=7.9555W_I=0.25A

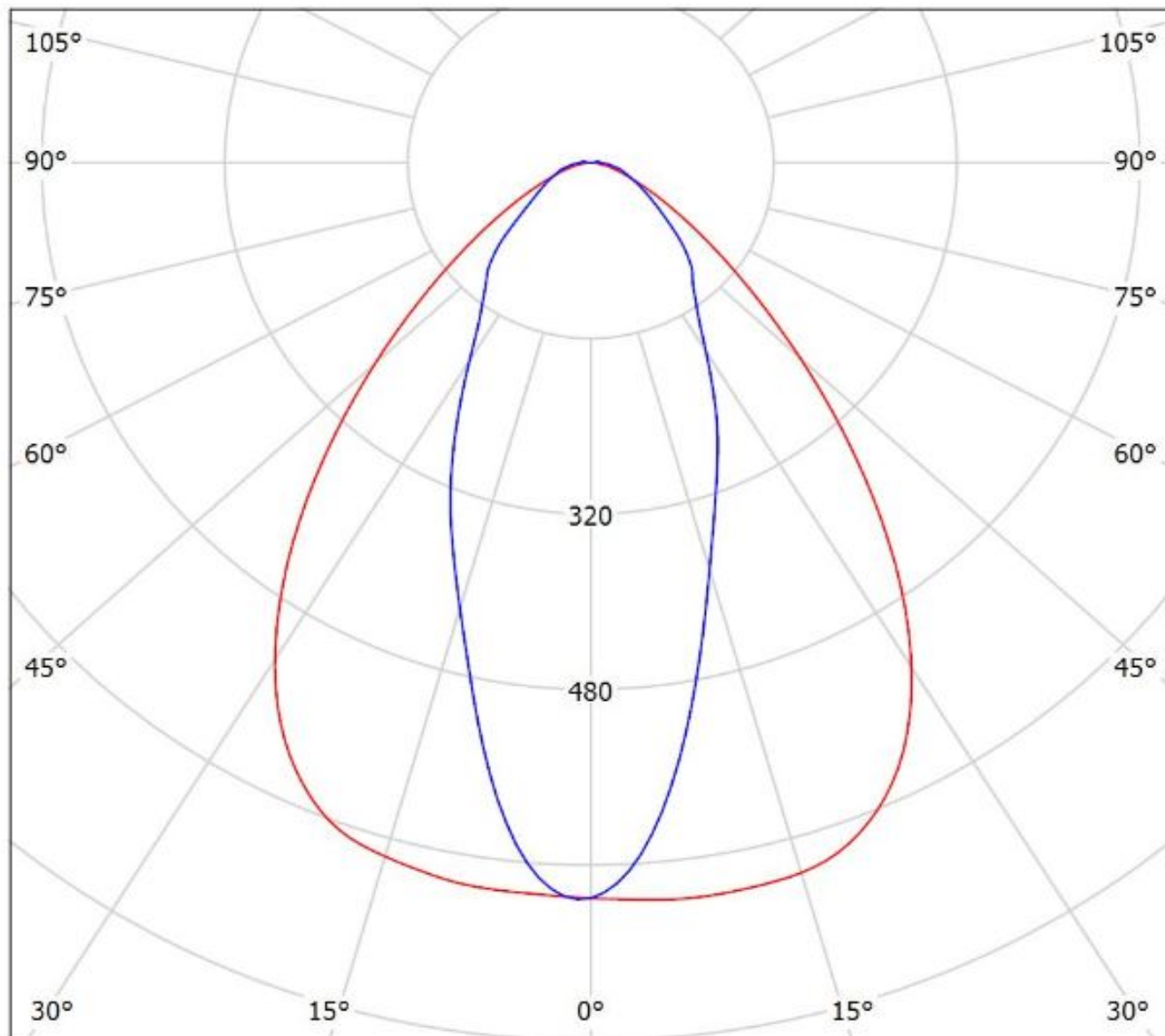

cd/klm

— C0 - C180 — C90 - C270

$\eta = 86\%$

Luminaire: Ledil Oy FS15847_FLORENCE-3R-IP-O_(Duris_S10)_SIMULATED
Lamps: 4 x Osram_Duris S10 with 90 degree rotation to next led

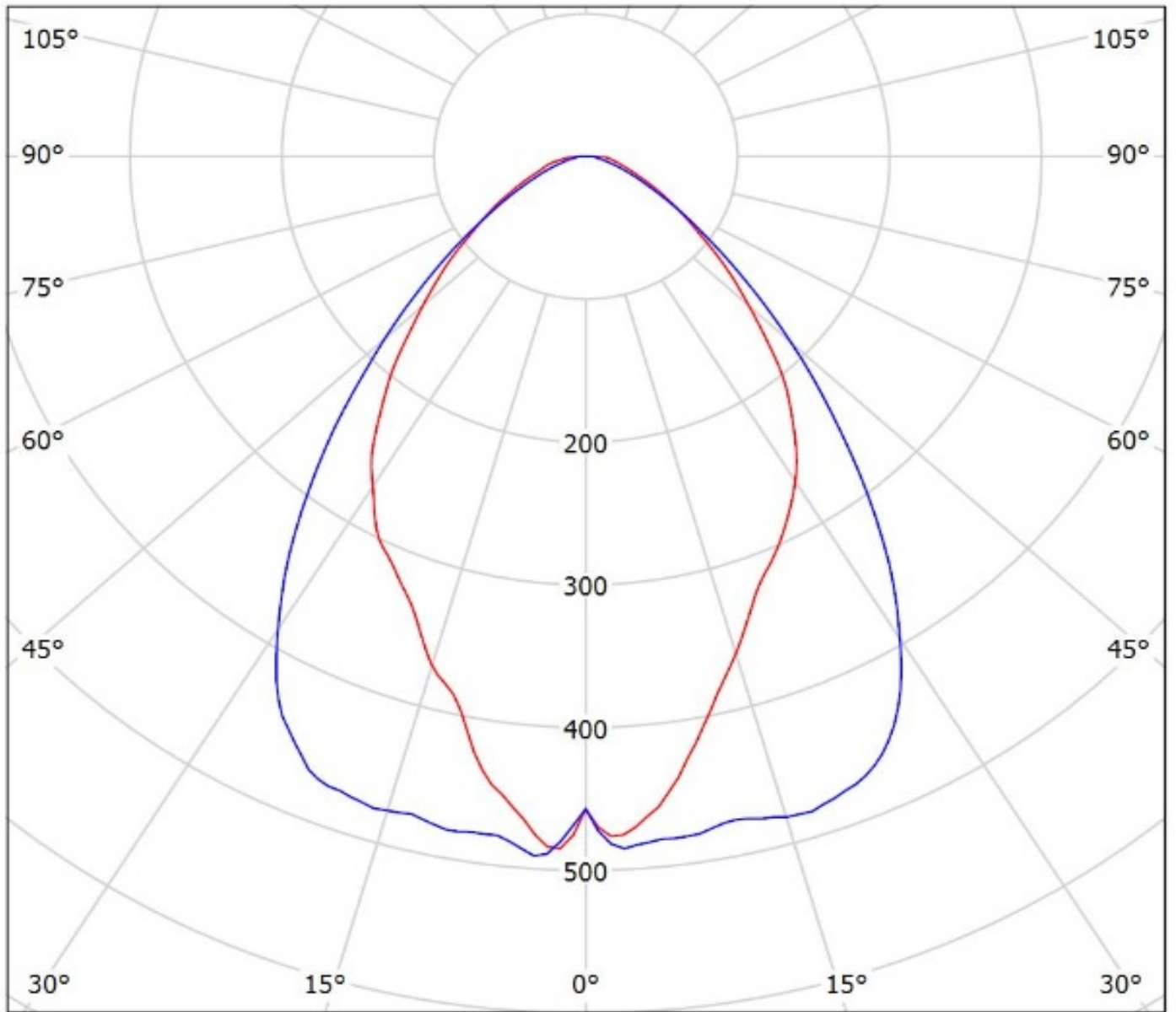

cd/klm

— C0 - C180 — C90 - C270

$\eta = 86\%$

Luminaire: Ledil Oy FS15847_FLORENCE-3R-IP-O_(Duris_S8)_SIMULATED
Lamps: 1 x Osram Duris S8 - GW P9LM31.EM

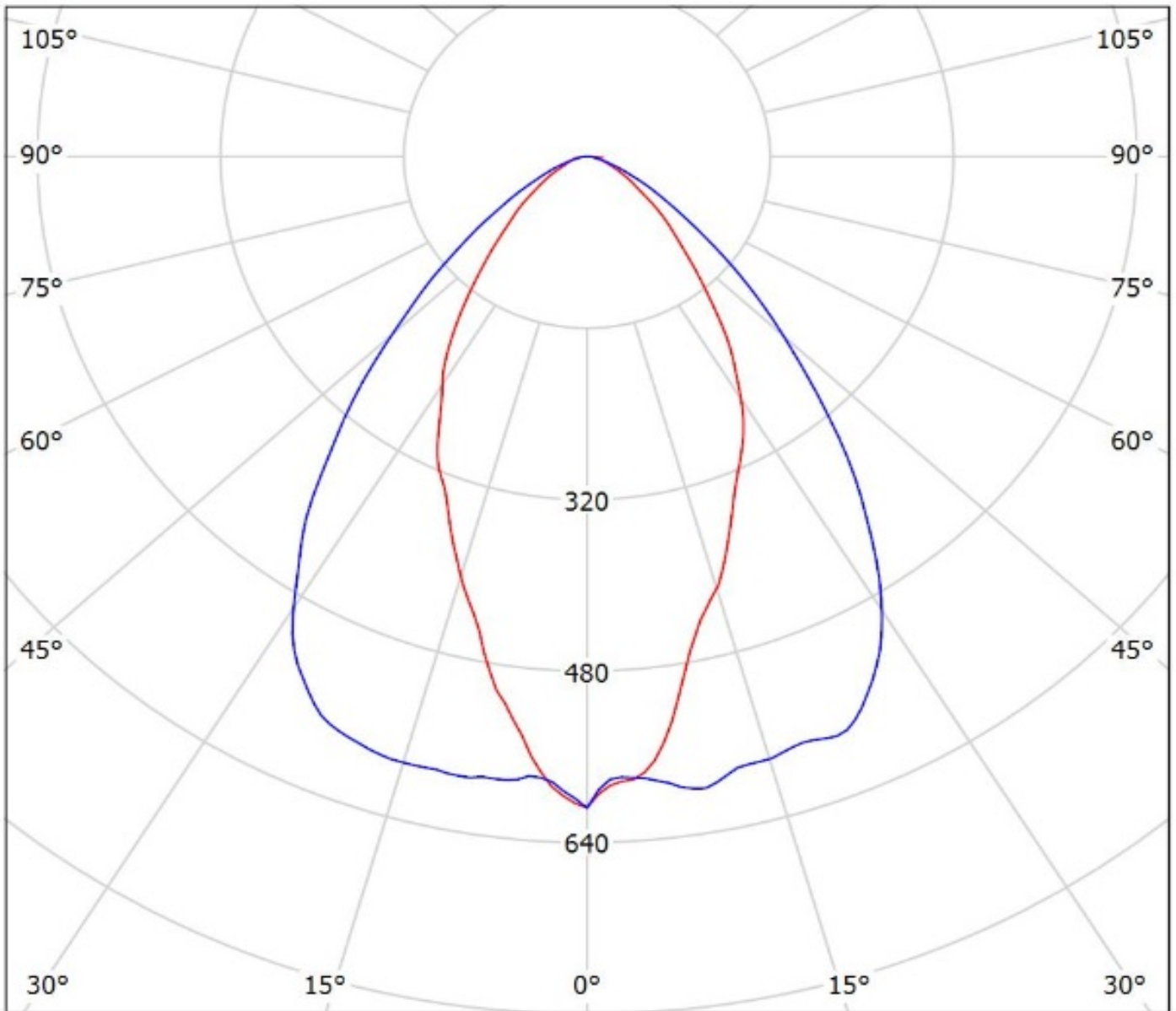

cd/klm

— C0 - C180 — C90 - C270

$\eta = 88\%$

Luminaire: LEDiL Oy FS15847_FLORENCE-3R-IP-O_(Fortimo_LED_Line_1ft_1100lm_840_3R_HV2)
Lamps: 1 x Fortimo_LED_Line_1ft_1100lm_840_3R_HV2_1035.97lm@250mA_P=7.91516W_η=0.25A

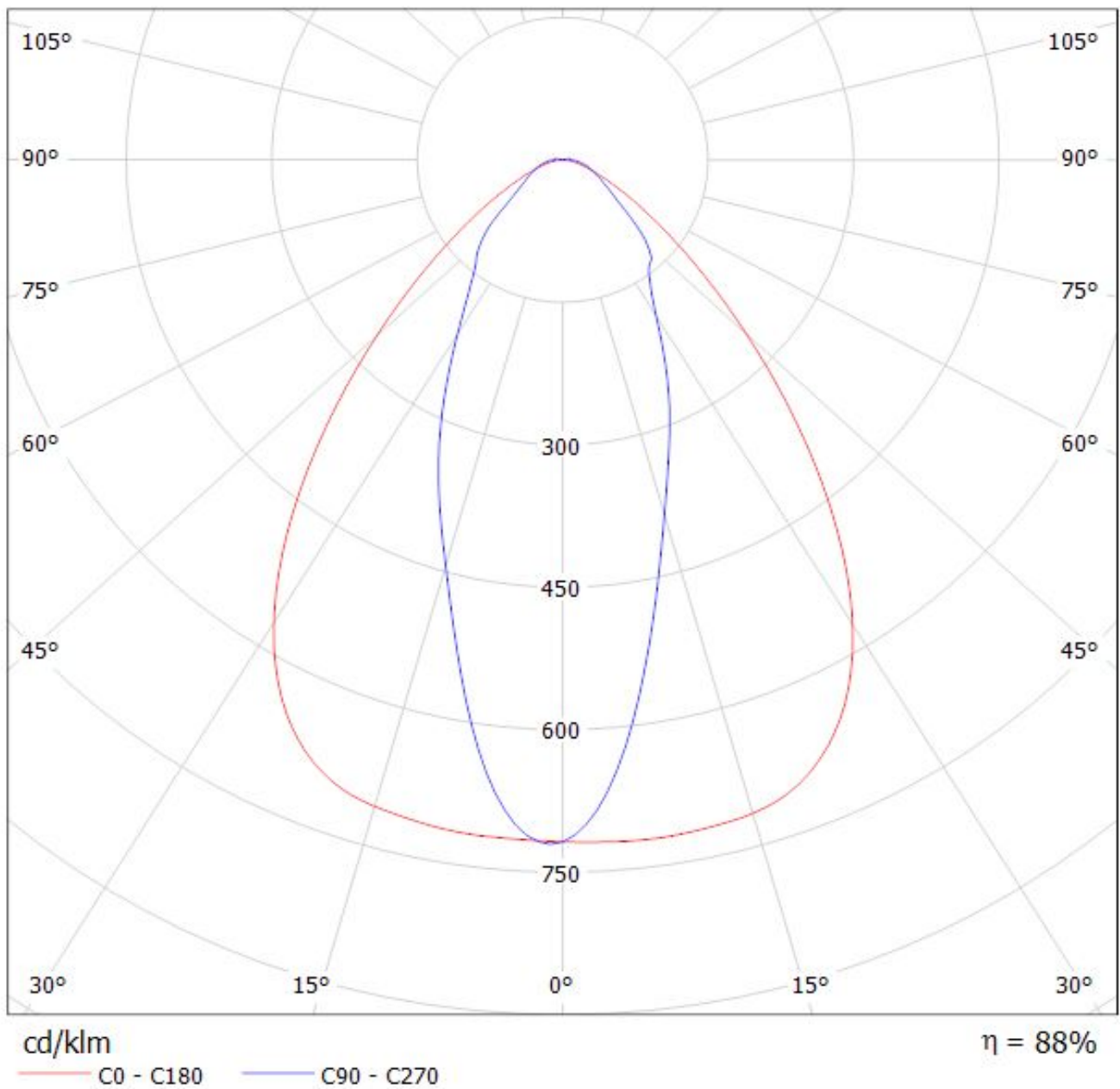

Luminaire: Ledil FS15847_FLORENCE-3R-IP-O_(Fortimo_LED_Line_1ft_2000lm_835_3R_HV2)

Lamps: 1 x Philips_Fortimo_LED_Line_1ft_2000lm_835_3R_HV2_(LG7030)_1226.7lm@250mA_P=7.54023W_I=0.250A

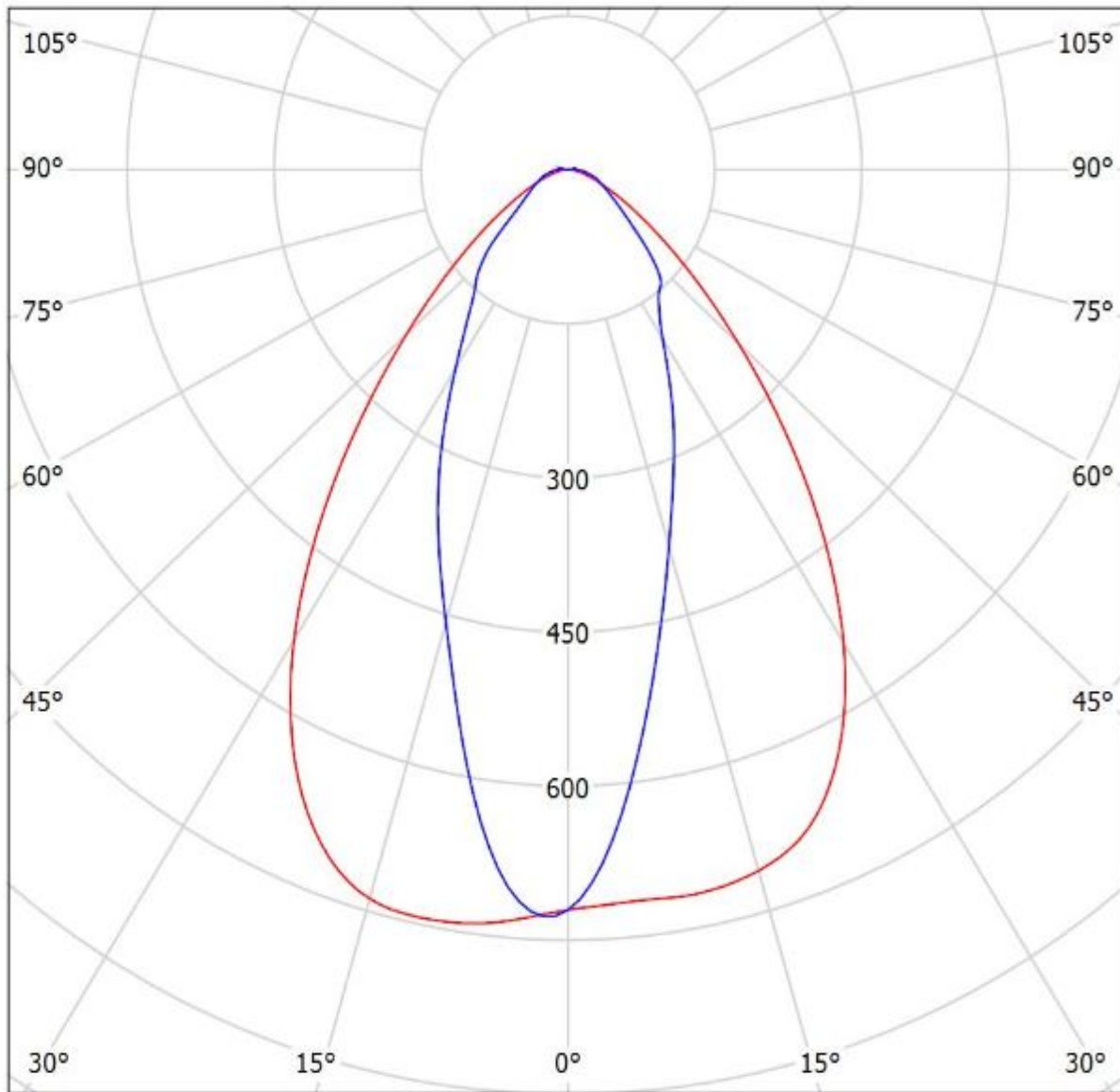

cd/klm

— C0 - C180 — C90 - C270

$\eta = 87\%$

Luminaire: LEDiL Oy FS15847_FLORENCE-3R-IP-O_(Philips_Fortimo_LED_Line_1ft_650lm_840_3R_LV3)
Lamps: 1 x Philips_Fortimo_LED_Line_1ft_650lm_840_3R_LV3_1122.62lm@250mA_P=8.18145W_I=0.250A

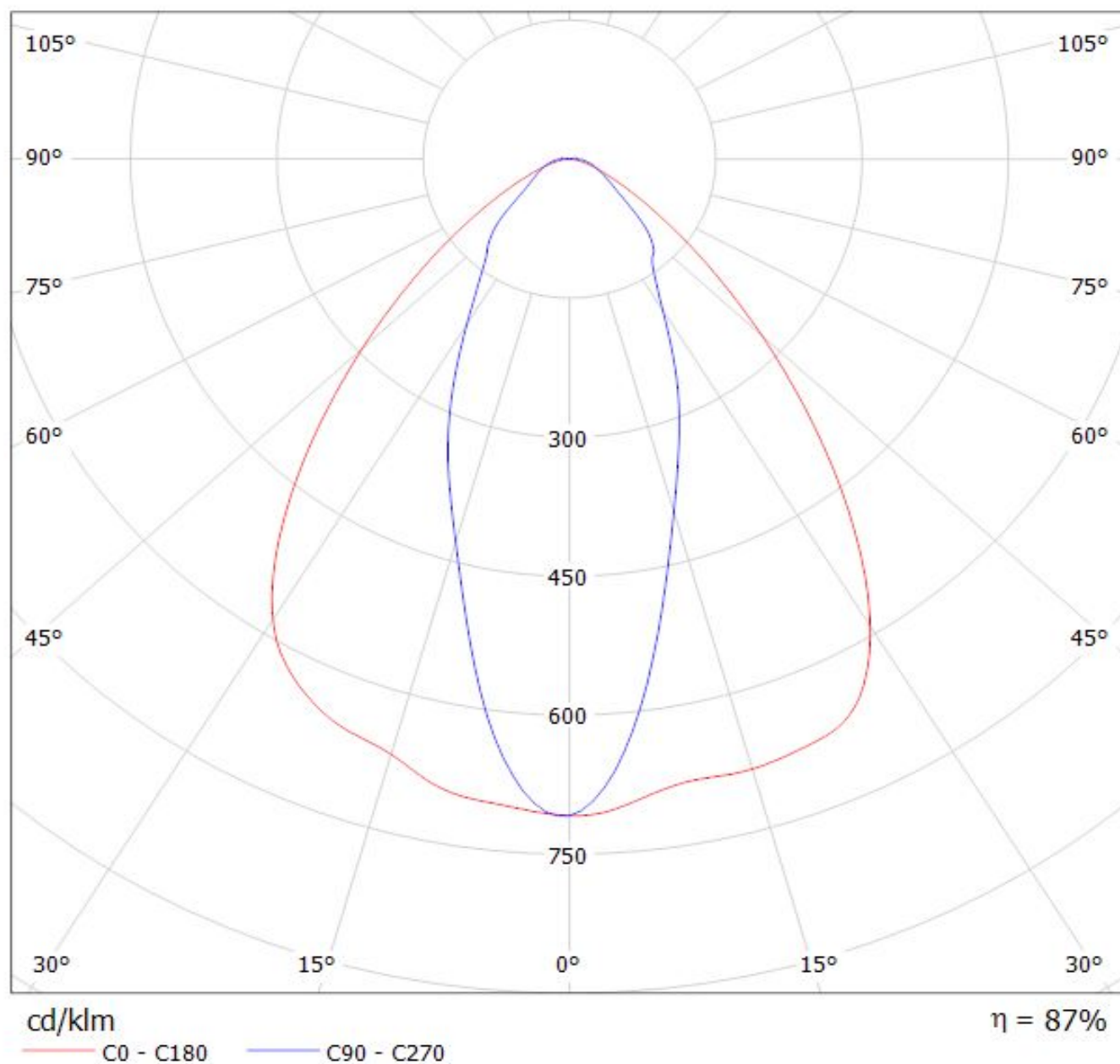

Luminaire: Ledil Oy FS15847_FLORENCE-3R-IP-O_(LM302B)_SIMULATED
Lamps: 4 x Samsung LM302B

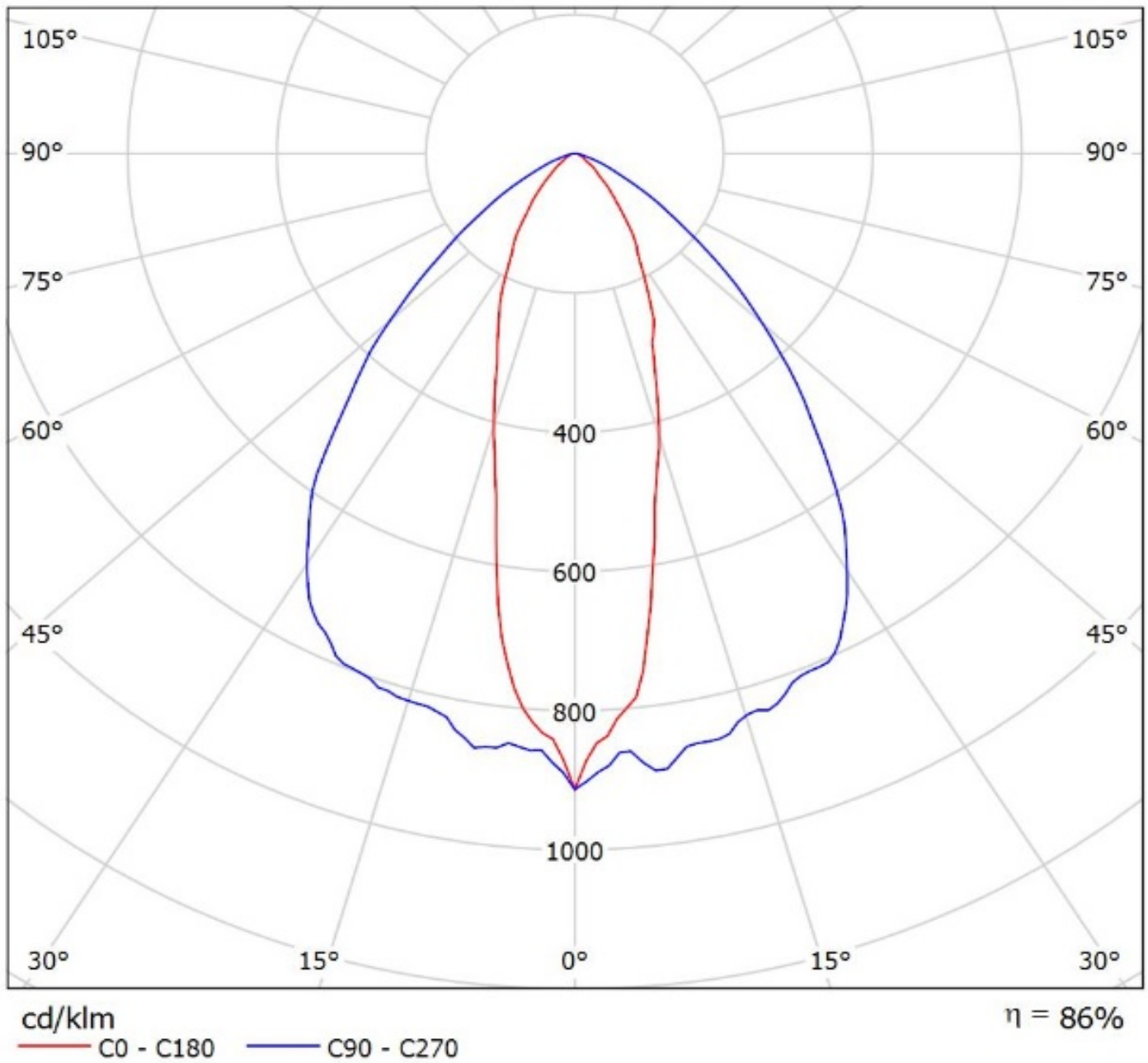

Luminaire: Ledil Oy FS15847_FLORENCE-3R-IP-O_(LM561B_PLUS)_SIMULATED
Lamps: 4 x Samsung LM561B PLUS

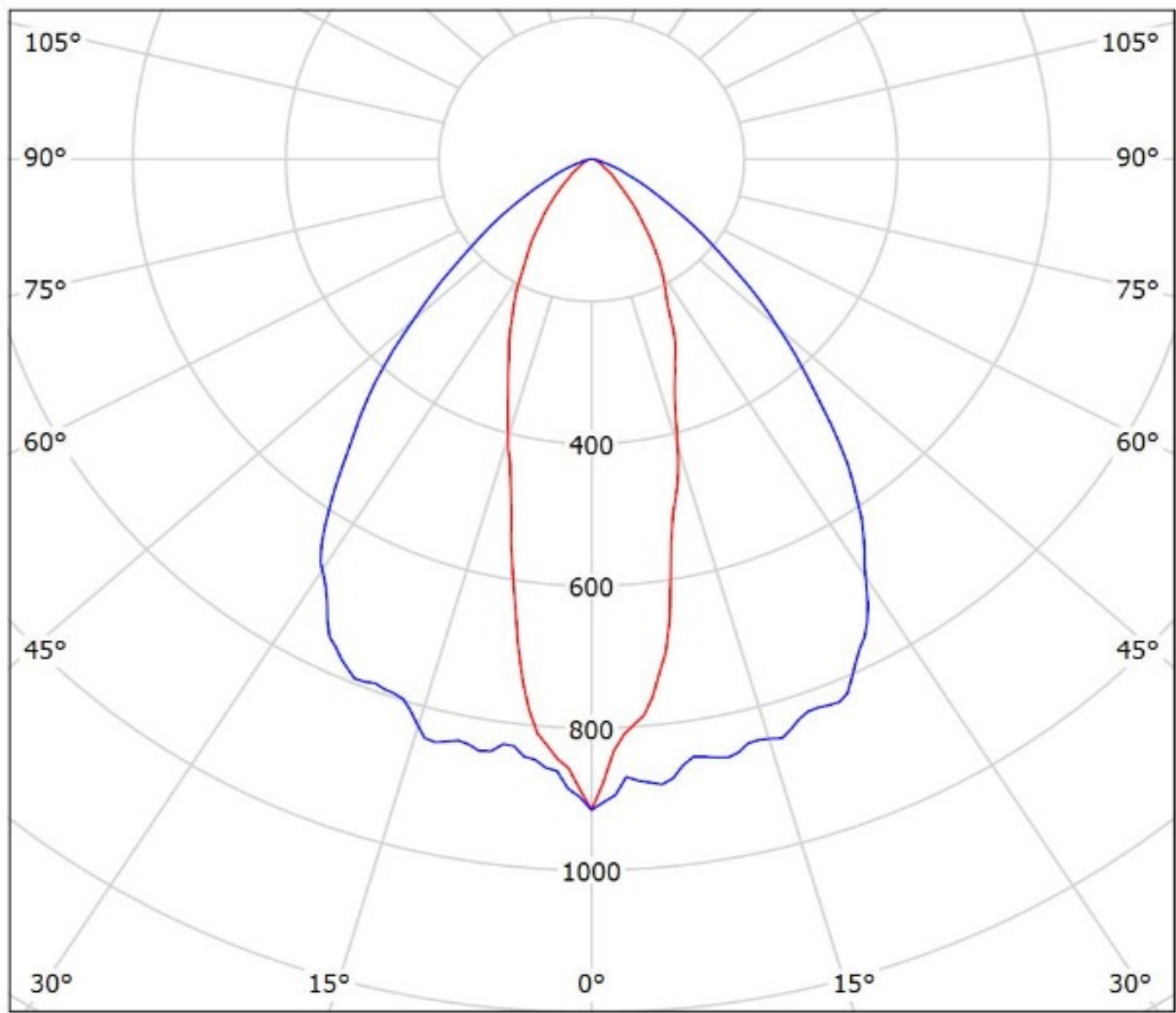

cd/klm
— C0 - C180 — C90 - C270

$\eta = 86\%$

Luminaire: Ledil Oy FS15847_FLORENCE-3R-IP-O_(Z8Y22)_SIMULATED

Lamps: 1 x Seoul Z8Y22

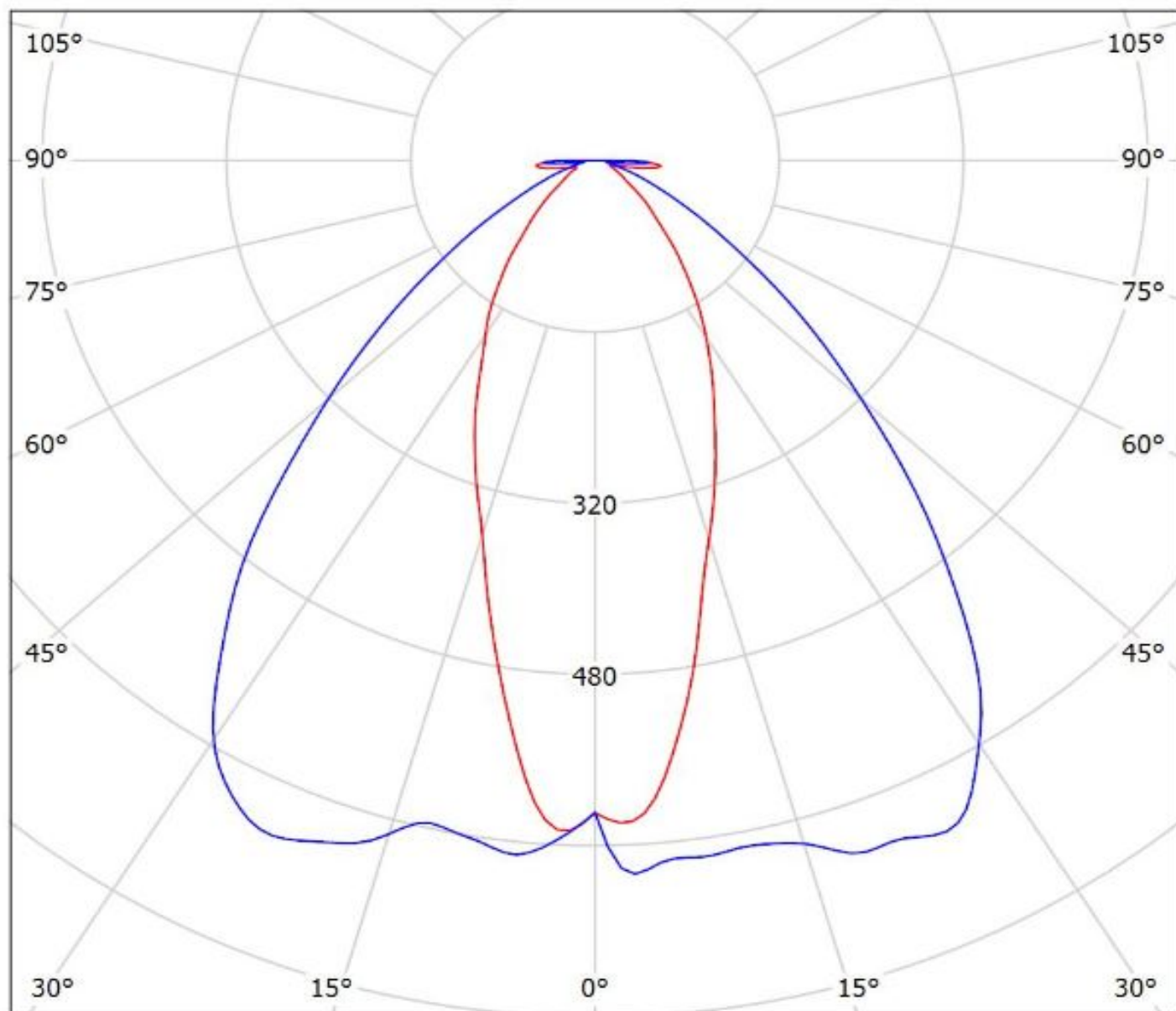

cd/klm

— C0 - C180 — C90 - C270

$\eta = 92\%$

Luminaire: Ledil Oy FS15847_FLORENCE-3R-IP-O_(Z8Y22P)_SIMULATED

Lamps: 1 x Seoul Z8Y22P

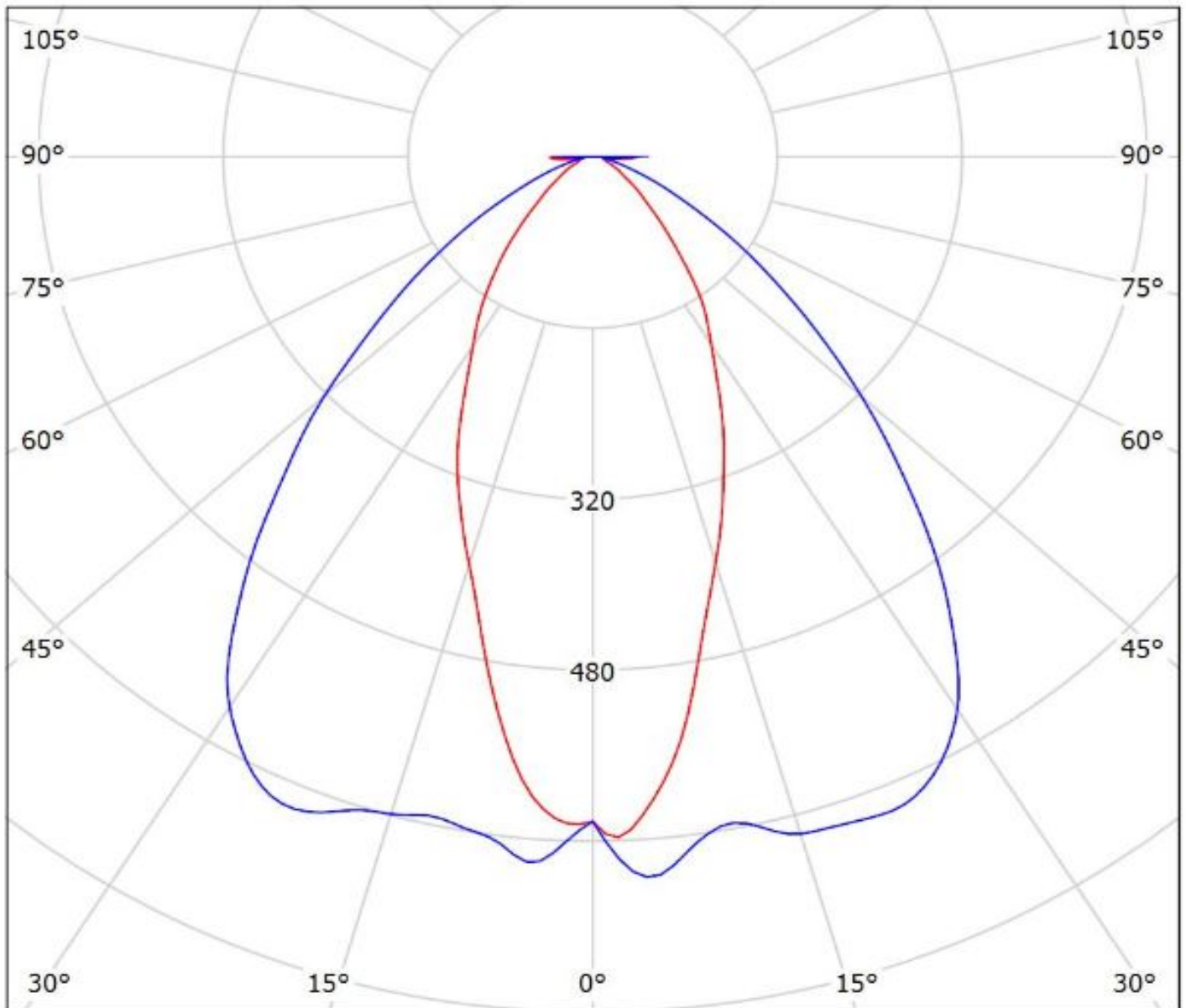

cd/klm

— C0 - C180 — C90 - C270

$\eta = 91\%$

Luminaire: Ledil Oy FS15847_FLORENCE-3R-IP-O_(SEOUL_3528_STW8A12D-E2)_SIMULATED
Lamps: 1 x Seoul 3528 STW8A12D-E2 - CCT: 4000 K

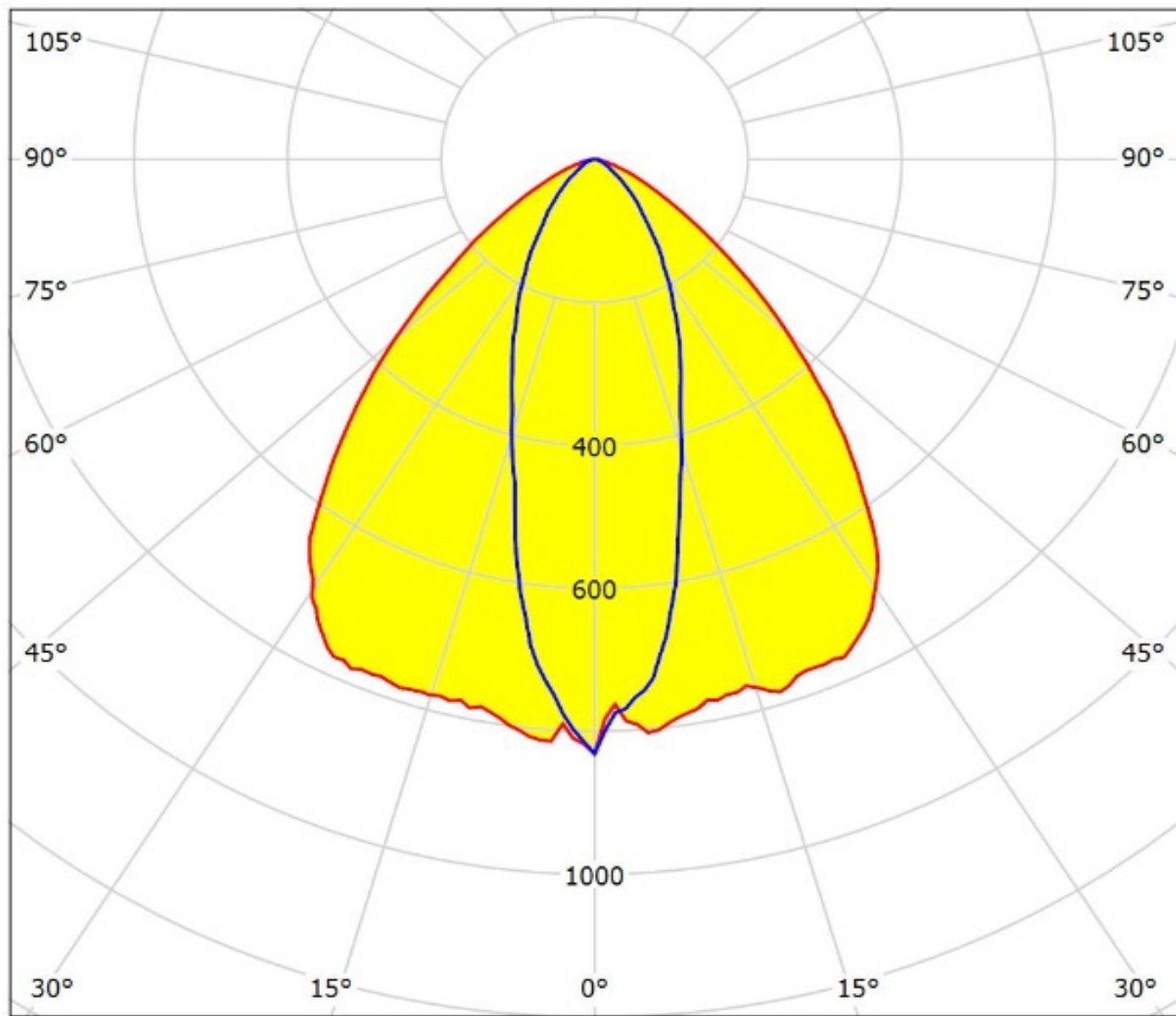

cd/klm

— C0 - C180 — C90 - C270

$\eta = 88\%$

NOTE: The typical divergence will be changed by different color, chip size and chip position tolerance. The typical total divergence is the full angle measured where the luminous intensity is half of the peak value.