

Pb-free
HEAT



KU163C

Reflector Sensor

Features

Function	Reflector Sensor (Analog Output)
Product features	<ul style="list-style-type: none">• Outer Dimension : 3.1 x 1.9 x 1.1mm (L x W x H)• Compact Small Package of Surface Mount• Integrated IRED and Phototransistor• Lead-free soldering compatible• RoHS compliant
Die materials (Emitter)	GaAs
Die materials (Detector)	Si
Assembly method	Auto pick & place machine (Auto Mounter)
Soldering methods	Reflow soldering, and manual soldering ※Please refer to Soldering Conditions about soldering.
Taping and reel	2,500pcs per reel in a 8mm width tape. (Standard) Reel diameter: ϕ 180mm

Recommended Applications

- Cameras, DSC (Lens Controller, Film Detection, Tape-end Detection)
- MO, DVD (Pick-up Controller, Disk Detection)
- Other General Applications for Controller (Object Detection, Code Reader)

Absolute Maximum Ratings

Item	Symbol	Absolute Maximum Ratings	Unit	
Operating Temperature	T_{opr}	-30~+85	°C	
Storage Temperature	T_{stg}	-40~+100	°C	
LED $T_a = 25^{\circ}\text{C}$	Power Dissipation	Pd	75	mW
	Forward Current	I_F	20	mA
	Derating ^{※1}	ΔI_F	0.17	mA/°C
	Pulse Forward Current ^{※2}	I_{FRM}	300	mA
	Pulse Forward Current Derating ^{※1}	ΔI_{FRM}	4	mA/°C
	Reverse Voltage	V_R	5	V
Phototransistor $T_a = 25^{\circ}\text{C}$	Collector Dissipation	Pc	75	mW
	Collector-Emitter Voltage	V_{CEO}	20	V
	Emitter-Collector Voltage	V_{ECO}	5	V
	Collector Current	Ic	20	mA

※1 $T_a=25^{\circ}\text{C}$ or higher

※2 I_{FRM} Measurement condition : Pulse Width $\leq 0.1\text{ms}$, Duty $\leq 1/100$

Electro-Optical Characteristics

(Ta=25°C)

Item	Conditions	Symbol	Characteristics		Unit
			MIN.	TYP.	
Input	I _F = 5mA	V _F	MIN.	0.9	V
			TYP.	1.1	
			MAX.	1.5	
	V _R = 5V	I _R	MAX.	10	μ A
	I _F = 20mA	λ _p	TYP.	940	nm
Output	V _{CEO} = 10V	I _{CEO}	MAX.	0.1	μ A
	-	λ _p	TYP.	850	nm
Coupling Characteristics	V _{CE} = 5V, I _F = 5mA, d = 1mm	I _c	MIN.	115	μ A
			TYP.	200	
			MAX.	425	
	V _{CE} = 5V, I _F = 5mA, No Reflector	I _{LEAK}	MAX.	2	μ A
	V _{CE} = 10V, R _L = 100Ω, I _F = 5mA	tr/tf	TYP.	10/10	μ s

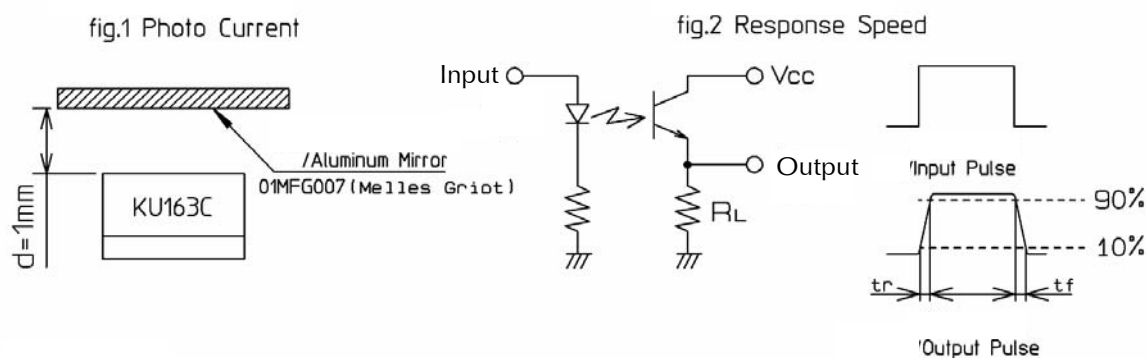
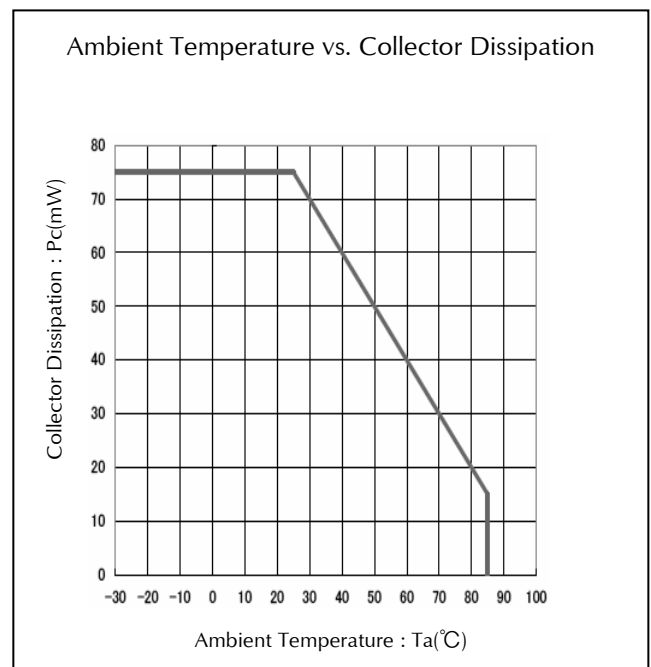
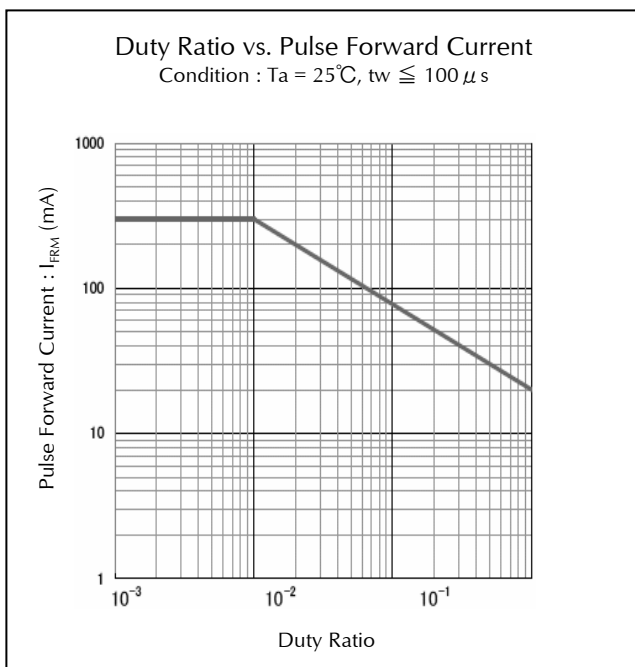
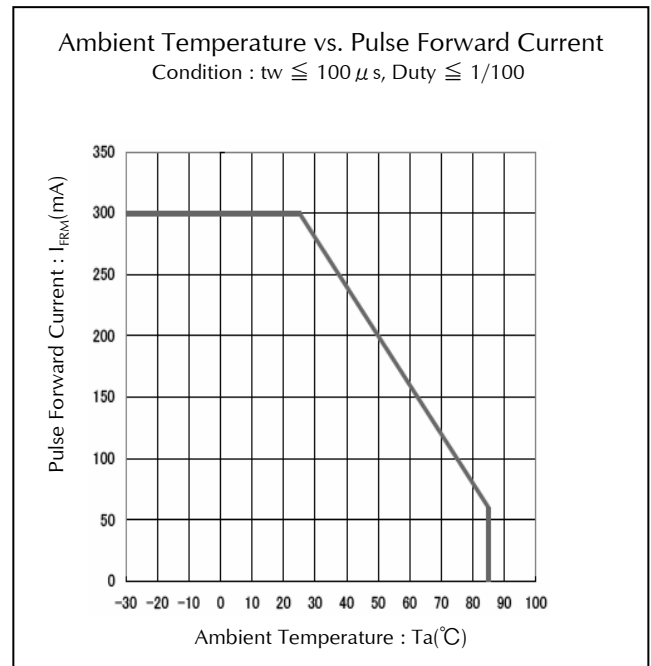
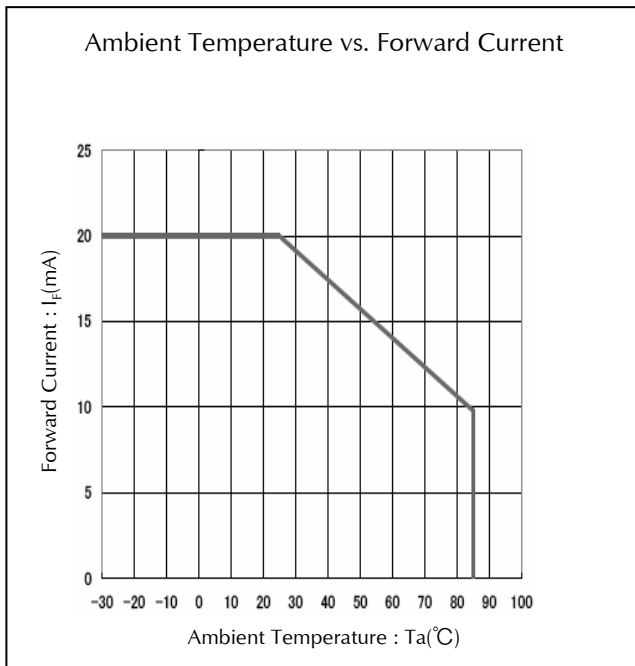

Photo Current Rank

Ranks	Photo Current I_C (μA)		Conditions
	MIN.	MAX.	
B	115	162	$I_F=5mA$ $V_{CE}=5V$ $d=1mm$
C	146	206	
D	185	262	
E	236	334	
F	300	425	

Technical Data



Technical Data

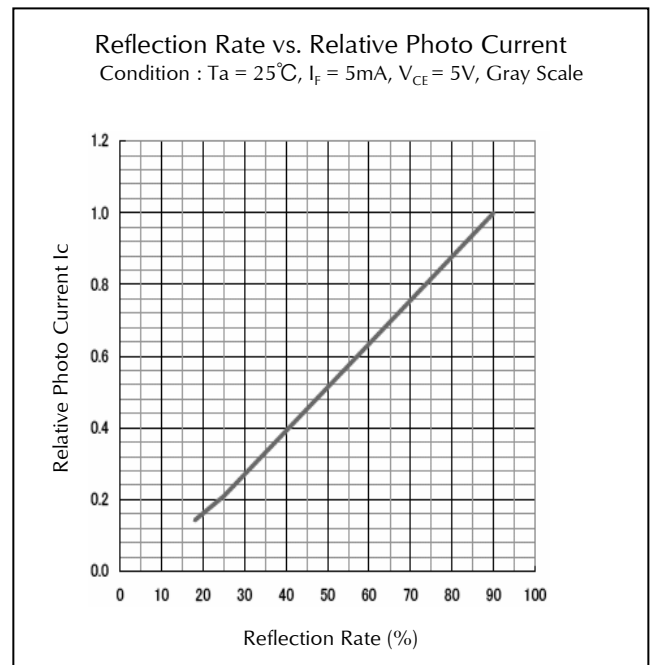
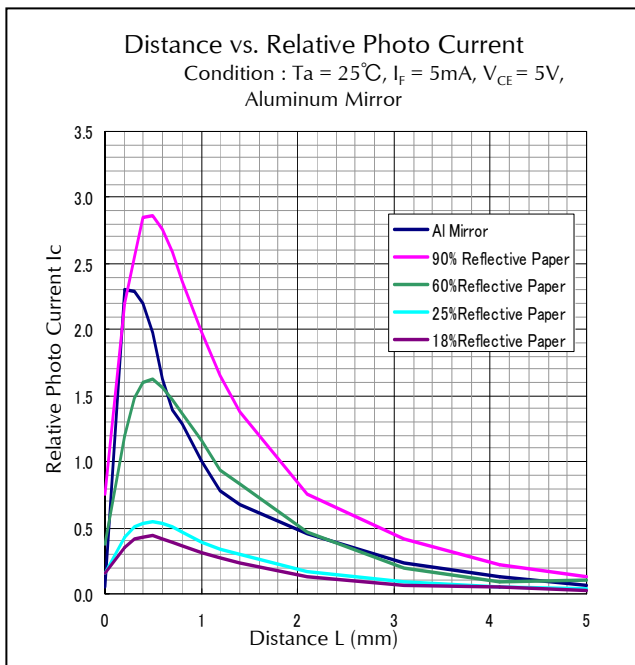
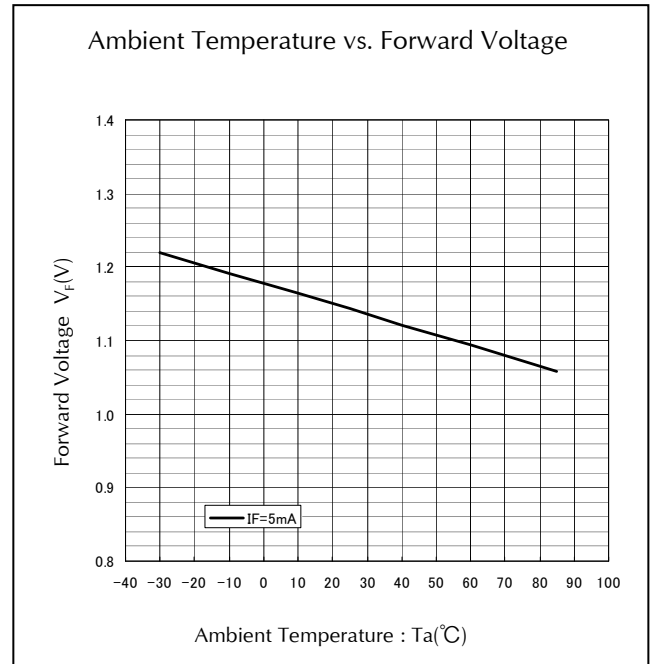
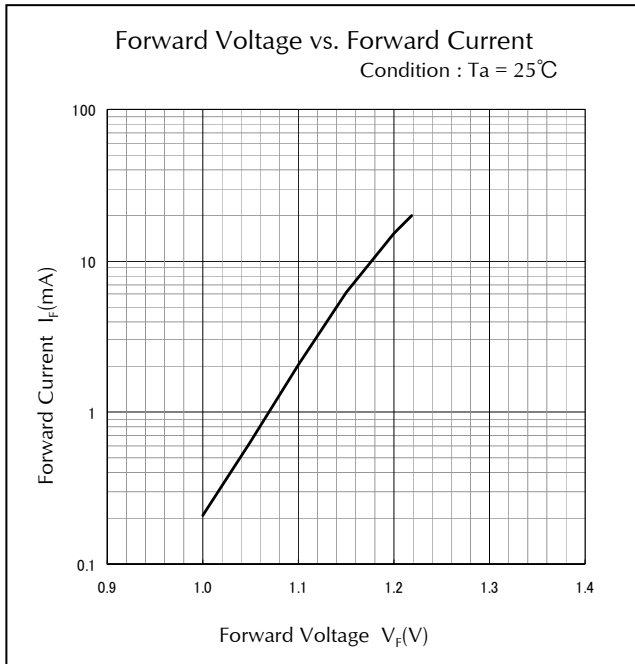

Technical Data

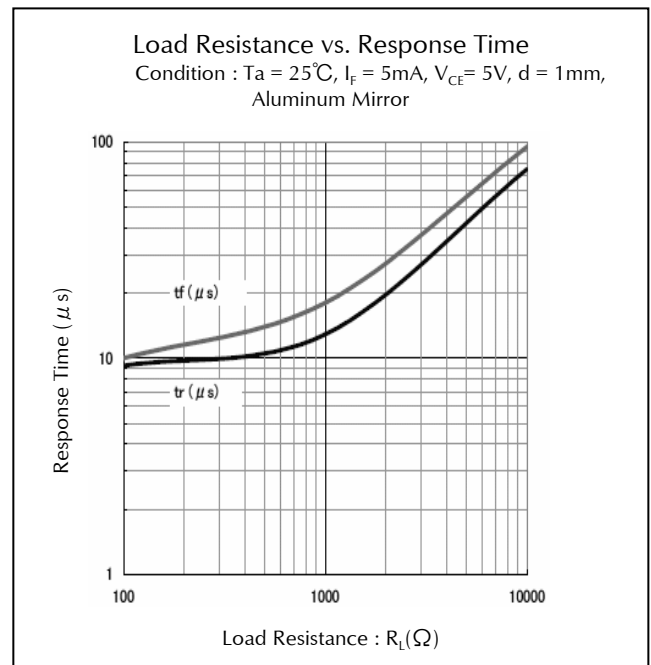
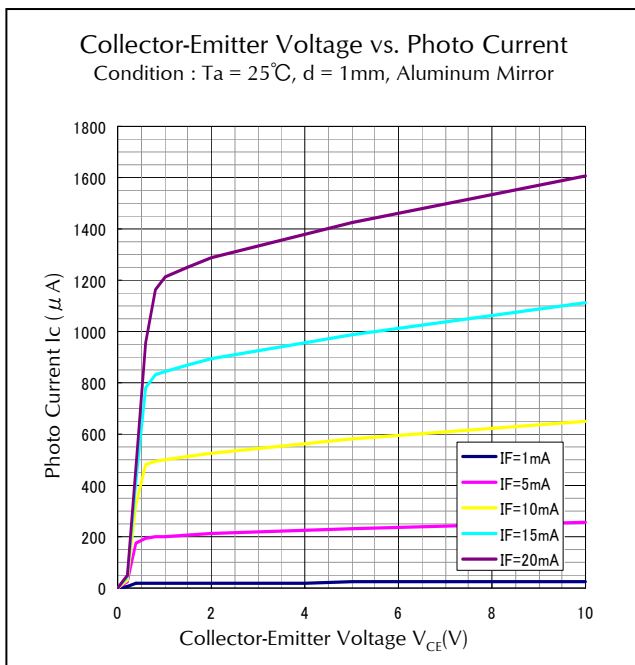
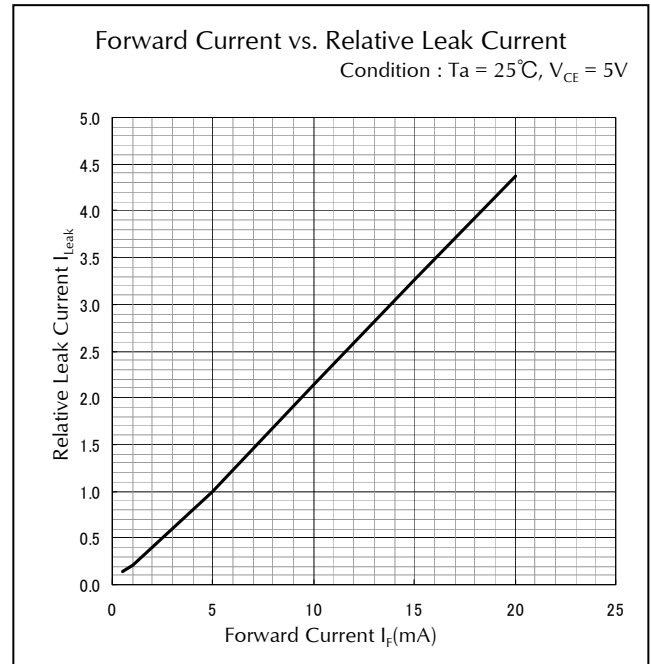
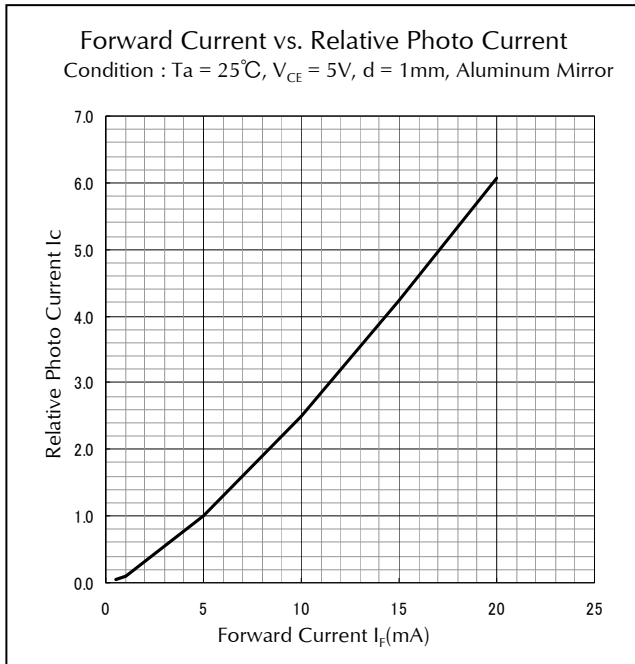

Technical Data

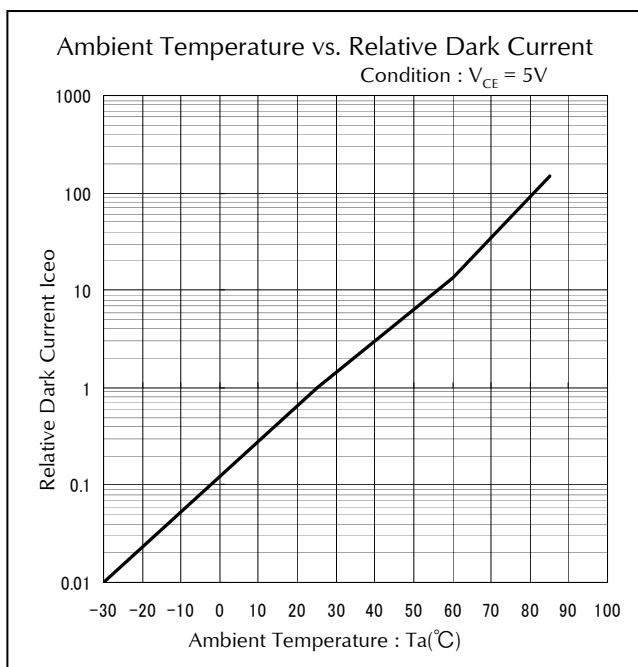
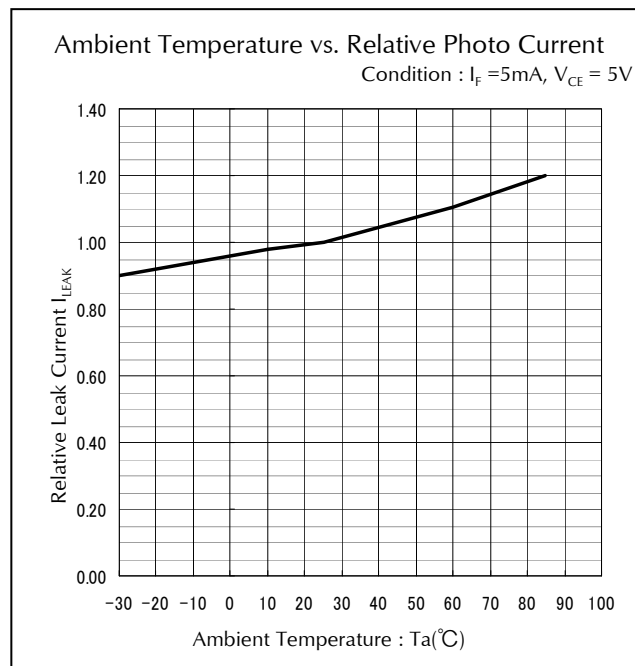
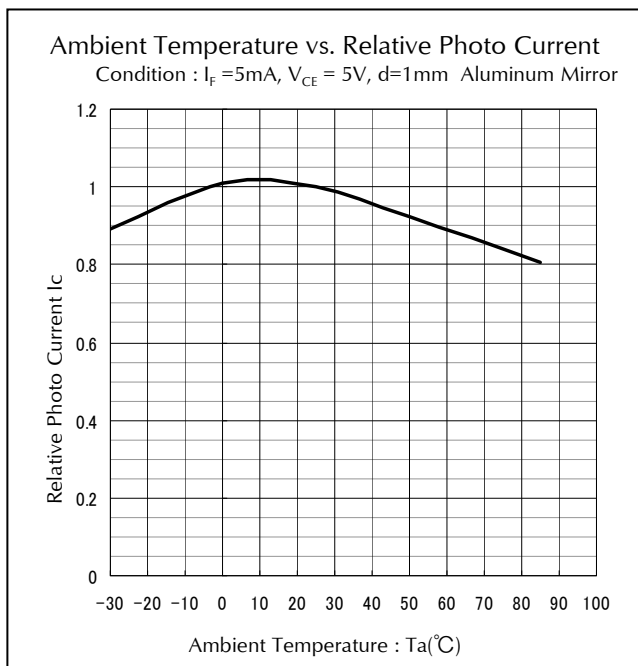

Technical Data

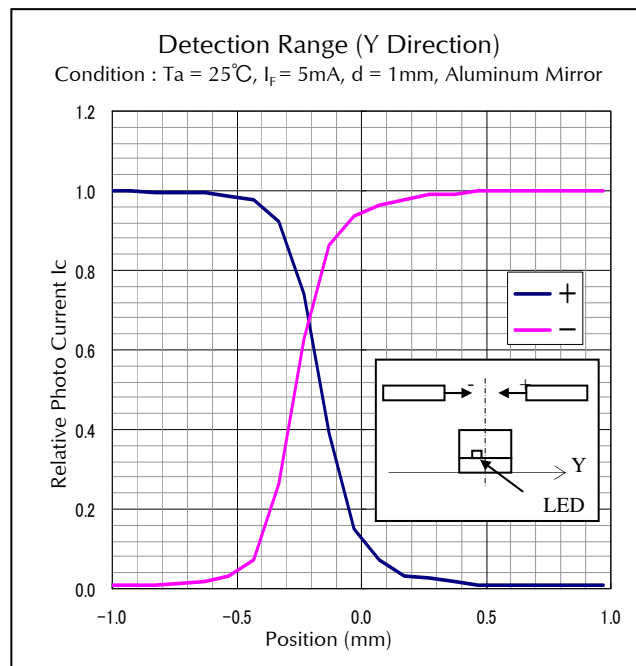
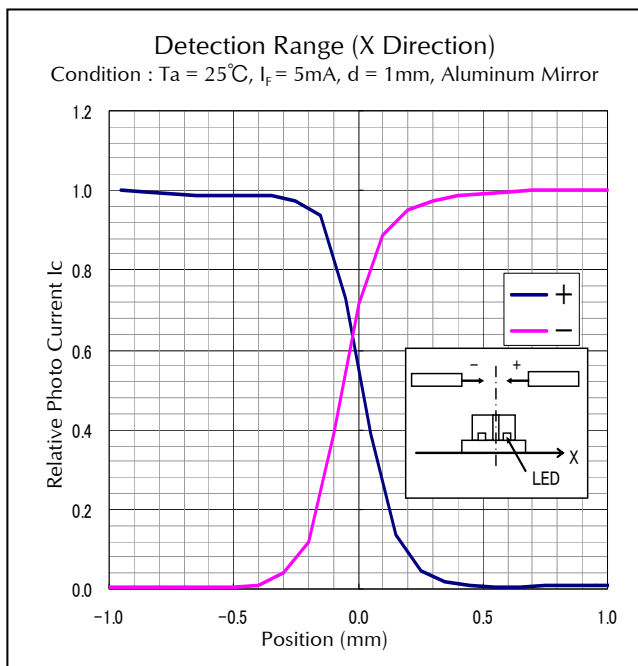

Package Dimensions

(Unit: mm)

MASS : (9.0mg)

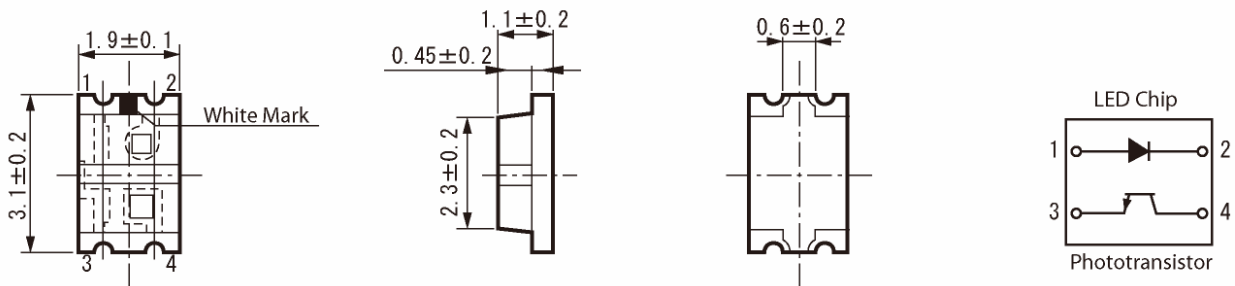

Recommended Soldering Pattern

(Unit: mm)

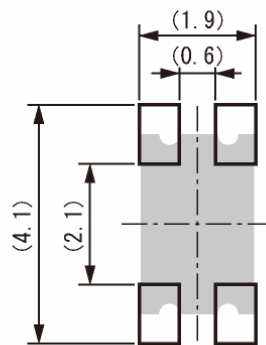

Taping Specification

(Unit: mm)

Quantity: 2,500pcs/ reel (standard)

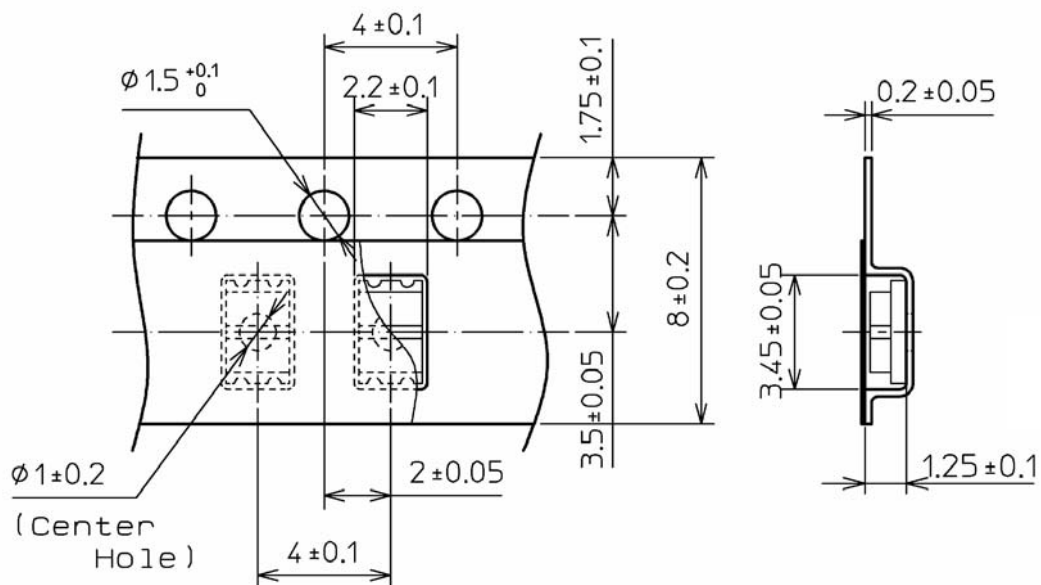

Reflow Soldering Conditions

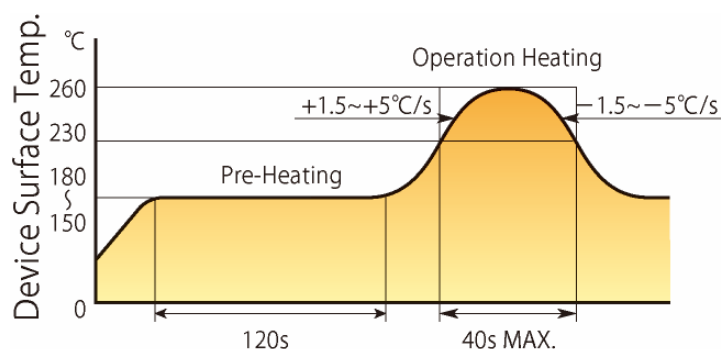

- 1) The above profile temperature gives the maximum temperature of the product resin surface. Please set the temperature so as to avoid exceeding this range.
- 2) Total times of reflow soldering process shall be no more than 2 times. When the second reflow soldering process is performed, intervals between the first and second reflow should be short as possible (while allowing some time for the component to return to normal temperature after the first reflow) in order to prevent the product from absorbing moisture.
- 3) Temperature fluctuation to the product during the pre-heating process shall be minimized.

Manual Soldering Conditions

- (1) Please avoid the installation of the substrate with the manual soldering as much as possible.**
If you do with the manual soldering, please note the following .

Iron tip temp.	350 °C	
Soldering time and frequency	3 s (MAX.)	1 time (MAX.) (Per One Terminal)

Reliability Testing Result

Reliability Testing Result	Applicable Standard	Testing Conditions	Duration	Failure
Room Temp. Operating Life	EIAJ ED-4701/100(101)	Ta = 25°C, LED : If = 5mA, Phototransistor : V _{CE} = 5V, There is a reflector., d = 1mm	1,000 h	0/25
Wet High Temp. Operating Life	EIAJ ED-4701/100(102)	Ta = 60°C, RH = 90%, LED : If = 5mA, Phototransistor : V _{CE} = 5V, There is a reflector., d = 1mm	1,000 h	0/25
High Temp. Operating Life	EIAJ ED-4701/100(101)	Ta = 85°C, LED : If = 5mA, Phototransistor : V _{CE} = 5V, There is a reflector., d = 1mm	1,000 h	0/25
Low Temp. Operating Life	EIAJ ED-4701/100(101)	Ta = -30°C, LED : If = 5mA, Phototransistor : V _{CE} = 5V, There is a reflector., d = 1mm	1,000 h	0/25
Thermal Shock	EIAJ ED-4701/200/(203)	-40°C(15min)~100°C(15min)	5 cycles	0/25
Resistance to Soldering Heat	EIAJ ED-4701/300(301)	(Reflow)Preheat : 150 ~ 180°C(120s Max.) Operating Heat : 230°C以上 (40s Max.) Peak : 260°C (5s Max.)	Twice	0/25

Failure Criteria

Items	Symbols	Conditions	Failure criteria
Forward Voltage	V _F	If=5mA	Testing Max.Value \geq Initial Value x 1.2
Reverse Current	I _R	V _R =5V	Testing Max.Value \geq 10 μ A x 2.5
Photo Current	I _C	If=5mA, V _{CE} =5V, d=1mm	Testing Max.Value \geq Initial Value x 1.2 Testing Min.Value \leq Initial Value x 0.8
Leak Current	I _{LEAK}	If=5mA, V _{CE} =5V, No Reflector	Testing Max.Value \geq 2 μ A x 1.2

Special Notice to Customers Using the Products and Technical Information Shown in This Data Sheet

- 1) The technical information shown in the data sheets are limited to the typical characteristics and circuit examples of the referenced products. It does not constitute the warranting of industrial property nor the granting of any license.
- 2) For the purpose of product improvement, the specifications, characteristics and technical data described in the data sheets are subject to change without prior notice. Therefore it is recommended that the most updated specifications be used in your design.
- 3) When using the products described in the data sheets, please adhere to the maximum ratings for operating voltage, heat dissipation characteristics, and other precautions for use. We are not responsible for any damage which may occur if these specifications are exceeded.
- 4) The products that have been described to this catalog are manufactured so that they will be used for the electrical instrument of the benchmark (OA equipment, telecommunications equipment, AV machine, home appliance and measuring instrument).
The application of aircrafts, space borne application, transportation equipment, medical equipment and nuclear power control equipment, etc. needs a high reliability and safety, and the breakdown and the wrong operation might influence the life or the human body. Please consult us beforehand if you plan to use our product for the usages of aircrafts, space borne application, transportation equipment, medical equipment and nuclear power control equipment, etc. except OA equipment, telecommunications equipment, AV machine, home appliance and measuring instrument.
- 5) In order to export the products or technologies described in this data sheet which are under the "Foreign Exchange and Foreign Trade Control Law," it is necessary to first obtain an export permit from the Japanese government.
- 6) No part of this data sheet may be reprinted or reproduced without prior written permission from Stanley Electric Co., Ltd.
- 7) The most updated edition of this data sheet can be obtained from the address below:
<http://www.stanley-components.com>