

Technical Data Sheet Mini-Top Infrared LEDs-RoHS Compliance EAIST2214A0

Features

- Low forward voltage.
- View angle 120°
- Small package
- Wide viewing angle
- Pb free
- The product itself will remain within RoHS compliant version.

Description

- Everlight Americas infrared emitting diode is a high intensity diode. Due to the package design ,the LED has wide viewing angle. The device is spectrally matched with phototransistor, photodiode and infrared receive module.

Applications

- Infrared applied system

Device Selection Guide

Device No.	Chip Material	Lens Color
EAIST2214A0	GaAlAs	Black

Package Dimensions

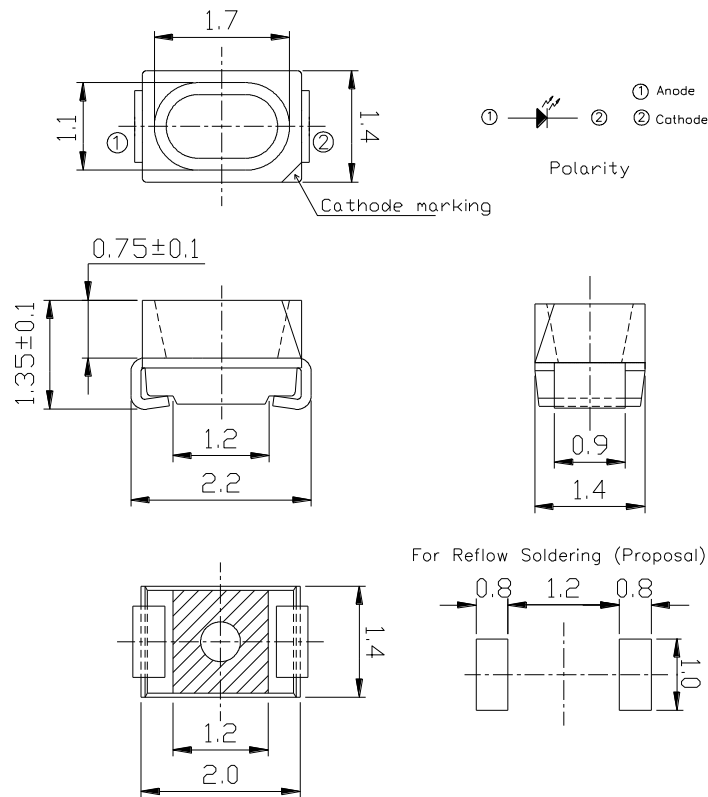

- Notes:** 1. All dimensions are in millimeters
2. Tolerances unless dimensions ± 0.1 mm

Absolute Maximum Ratings ($T_a=25^\circ\text{C}$)

Parameter	Symbol	Rating	Unit
Continuous Forward Current	I_F	65	mA
Reverse Voltage	V_R	5	V
Operating Temperature	T_{opr}	-40 ~ +100	$^\circ\text{C}$
Storage Temperature	T_{stg}	-40 ~ +100	$^\circ\text{C}$
Soldering Temperature *1	T_{sol}	260	$^\circ\text{C}$
Power Dissipation at(or below) 25 $^\circ\text{C}$ Free Air Temperature	P_d	130	mW

Notes:*1: Soldering time ≤ 5 seconds.

Electro-Optical Characteristics (Ta=25°C)

Parameter	Symbol	Min.	Typ.	Max.	Unit	Condition
Radiant Intensity	I _e	4	8	--	mW/sr	I _F =100mA Pulse Width ≤ 100μ s ,Duty ≤ 1%
			--	48		I _F =1A Pulse Width ≤ 100μ s ,Duty ≤ 1%
Peak Wavelength	λ _p	--	940	--	nm	I _F =20mA
Spectral Bandwidth	Δλ	--	45	--	nm	I _F =20mA
Forward Voltage	V _F		1.2	1.5	V	I _F =20mA
		--	1.4	1.8		I _F =100mA Pulse Width ≤ 100μ s ,Duty ≤ 1%
		--	2.6	4.0		I _F =1A Pulse Width ≤ 100μ s ,Duty ≤ 1%
Reverse Current	I _R	--	--	10	μ A	V _R =5V
View Angle	2θ _{1/2}	--	120	--	deg	I _F =20mA

Typical Electrical/Optical/Characteristics Curves

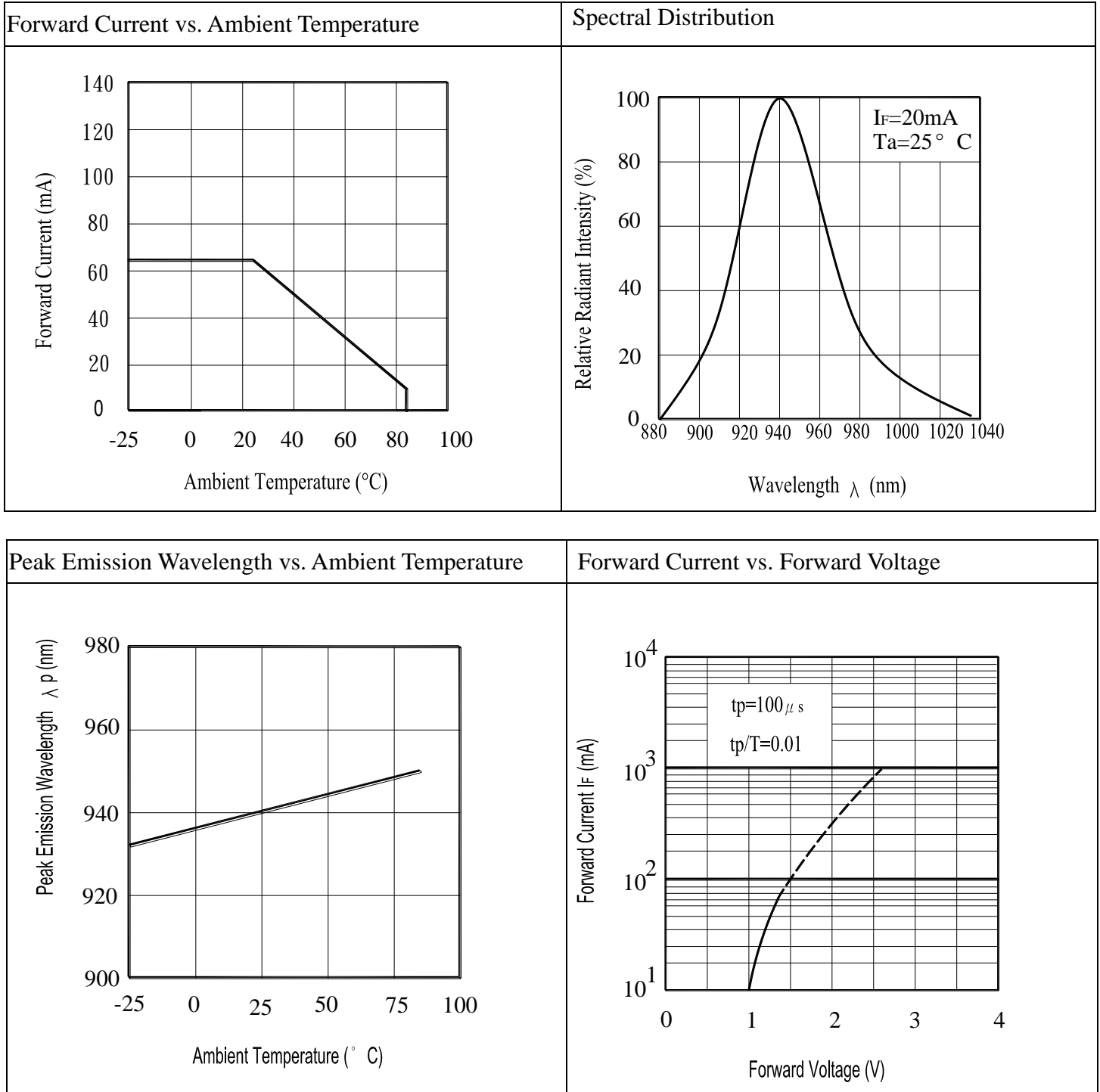

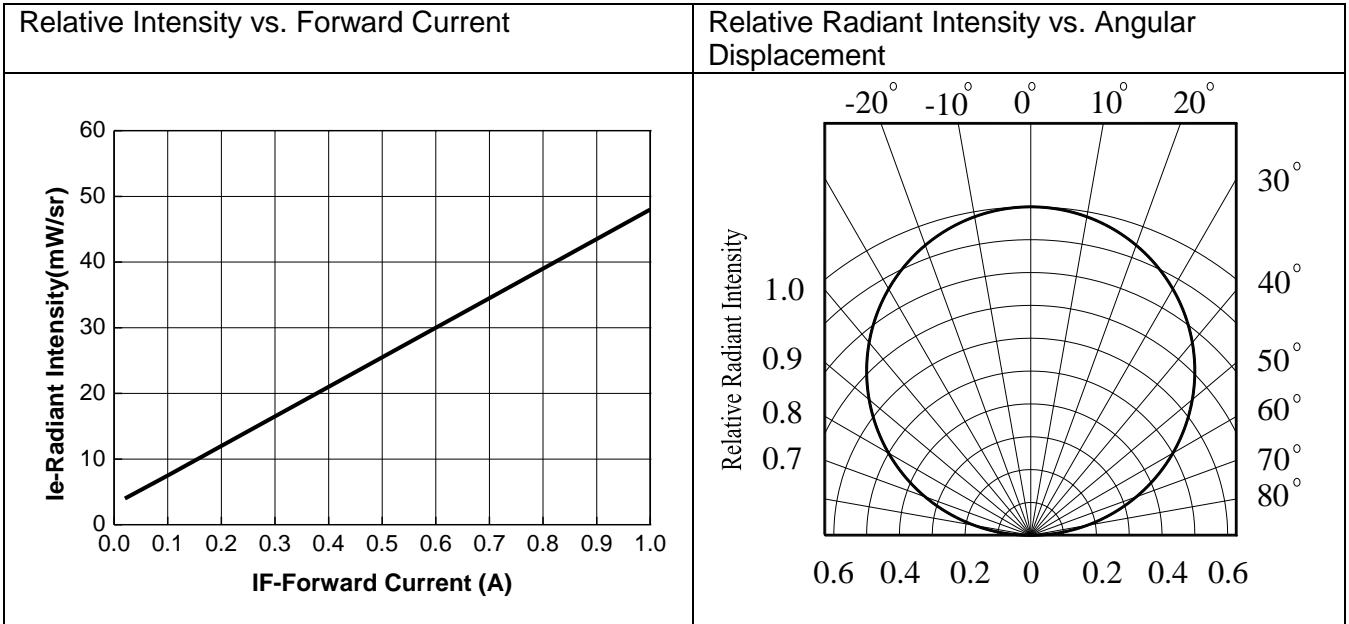

● **Precautions For Use**

1. Over-current-proof

Customer must apply resistors for protection , otherwise slight voltage shift will cause big current change (Burn out will happen).

2. Storage

- 2.1 Do not open moisture proof bag before the products are ready to use.
- 2.2 Before opening the package, the LEDs should be kept at 30°C or less and 90%RH or less.
- 2.3 The LEDs should be used within a year.
- 2.4 After opening the package, the LEDs should be kept at 30°C or less and 60%RH or less.
- 2.5 The LEDs should be used within 168 hours (7 days) after opening the package
- 2.6 If the moisture absorbent material (silica gel) has faded away or the LEDs have exceeded the storage time, baking treatment should be performed using the following conditions.
Baking treatment : 60±5°C for Min. 24 hours.

3. Soldering Condition

3.1 Pb-free solder temperature profile

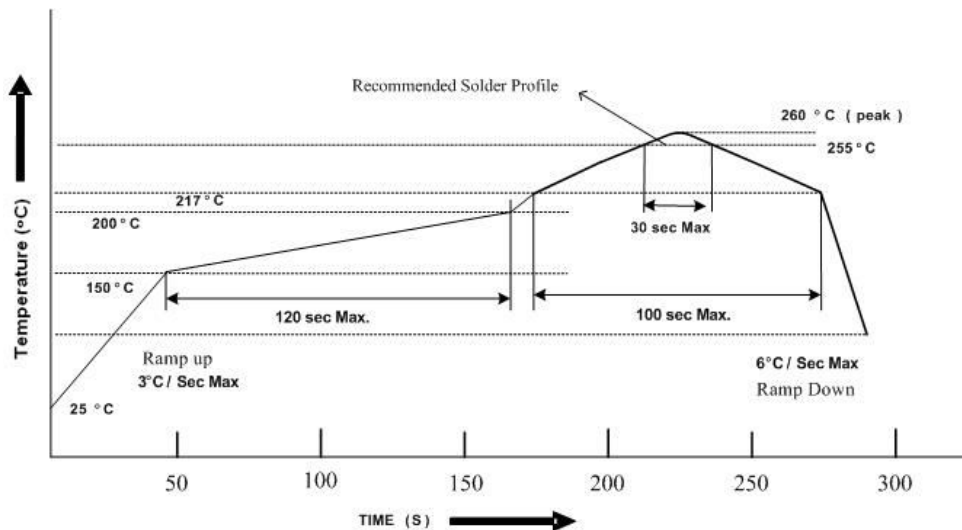

- 3.2 Reflow soldering should not be done more than two times.
- 3.3 When soldering, do not put stress on the LEDs during heating.
- 3.4 After soldering, do not warp the circuit board.

4. Soldering Iron

Each terminal is to go to the tip of soldering iron temperature less than 350°C for 3 seconds within once in less than the soldering iron capacity 25W. Leave two seconds and more intervals, and do soldering of each terminal. Be careful because the damage of the product is often started at the time of the hand solder.

5. Repairing

Repair should not be done after the LEDs have been soldered. When repairing is unavoidable, a double-head soldering iron should be used (as below figure). It should be confirmed beforehand whether the characteristics of the LEDs will or will not be damaged by repairing.



Package Dimensions

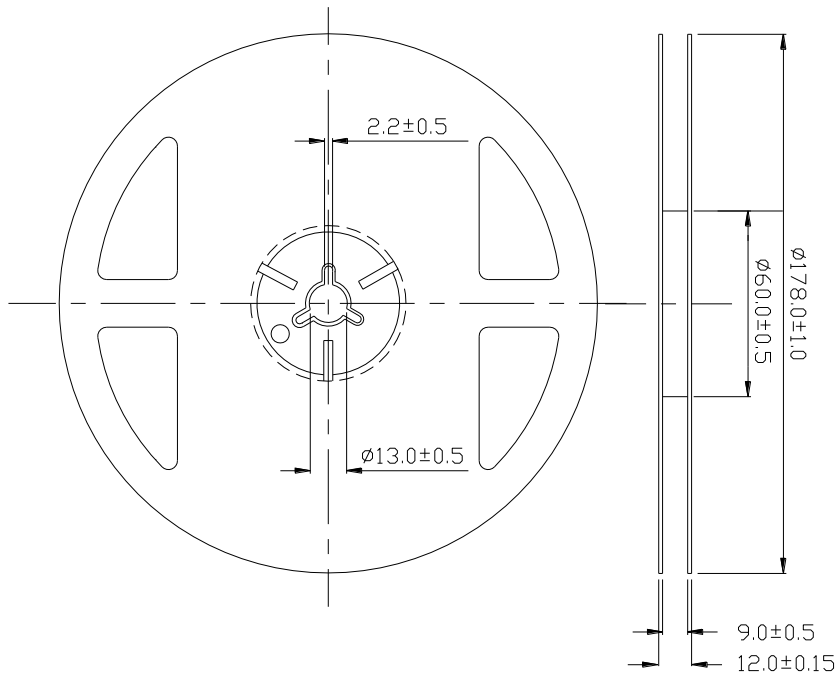

Note: The tolerances unless mentioned is ± 0.1 mm ,Unit = mm

2. Carrier Tape Dimensions:(Quantity: 1500pcs/reel)

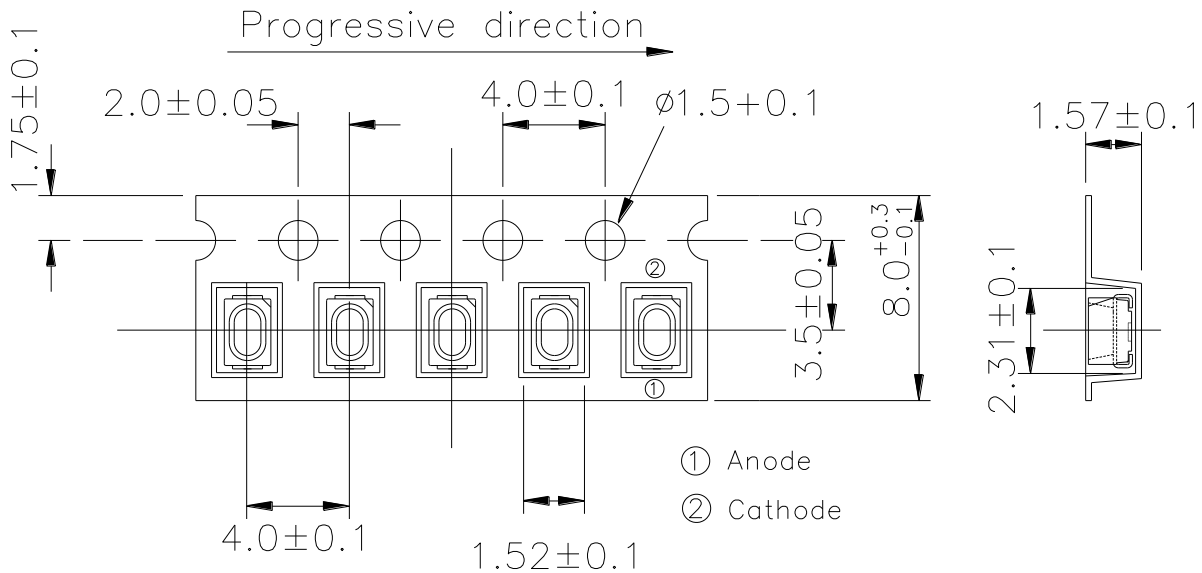

Note: The tolerances unless mentioned is ± 0.1 mm ,Unit = mm

Packing Procedure

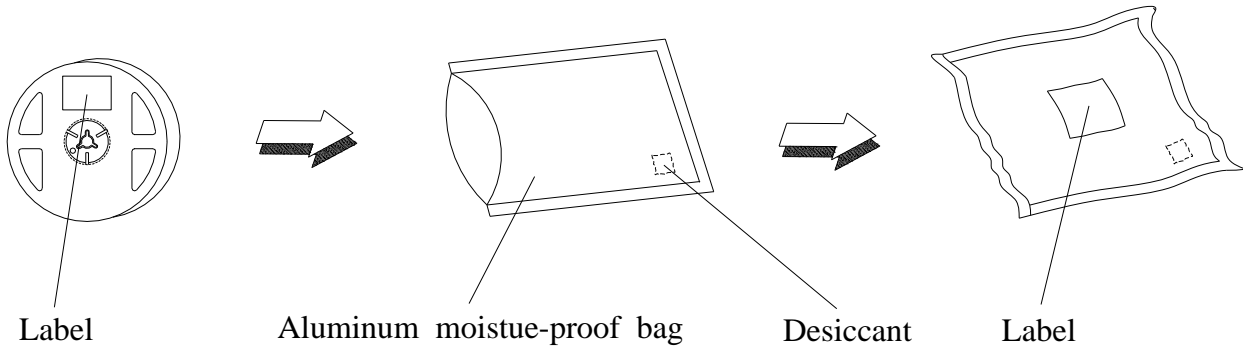

Label Form Specification

	EVERLIGHT AMERICA	
CPN: XXXXXXXXXXXX		
P/N: XXXXXXXXXXXX		
		RoHS
XXXXXXXXXXXXXXXXXXXX		
QTY: XXXX	CAT: XXX	
	HUE: XXX	
	REF: XXX	
LOT NO: XXXXXXXXXXXXXXXXXXXX		
REFERENCE: XXXXXXXXXXXX		
MADE IN TAIWAN		

CPN: Customer's Production Number
P/N : Production Number
QTY: Packing Quantity
CAT: Ranks
HUE: Peak Wavelength
REF: Reference
LOT No: Lot Number
MADE IN TAIWAN: Production Place

Notes

1. Above specification may be changed without notice. Everlight Americas will reserve authority on material change for above specification.
2. When using this product, please observe the absolute maximum ratings and the instructions for using outlined in these specification sheets. Everlight Americas assumes no responsibility for any damage resulting from use of the product which does not comply with the absolute maximum ratings and the instructions included in these specification sheets.
3. These specification sheets include materials protected under copyright of Everlight Americas corporation. Please don't reproduce or cause anyone to reproduce them without Everlight Americas's consent.