



300mA Linear Regulator with Enable And Fast Discharge Function

Description

The EC49513A/L is a 4-Low (Low dropout, Low quiescent Current, Low noise, Low cost) linear regulator with ON/OFF control and EC49513L can discharge output capacitor charge fast. The device operates in the input voltage range from +2.2V to +7.0V and delivers 300mA output current.

The high accuracy output voltage is preset at an internally trimmed voltage 1.2V, 1.5V, 1.8V, 2.5V, 2.8V, 3.0V or 3.3V. Other output voltages can be mask optioned from 1.2V to 5.0V with 100mV increment, except the EC49513A/L-285 which has 2.85V output voltage.

The EC49513A/L consists of a 1.0V reference compares amplifier, a P-channel pass transistor, and an enable/disable logic circuit. Other features include soft start function, short circuit protection, and thermal shutdown protection.

The EC49513A/L is also compatible with low ESR ceramic capacitors which give added output stability. This stability can be maintained even during load fluctuations due to the excellent transient response of the chip. The EC49513A/L devices are available in SOT23-5L、UFN-6 and TSOT23-5 packages.

Features

- EC49513A/L Without / With Fast Discharge
- Operating Voltage Range : +2.2V to +7.0V
- Output Voltages: +1.2V to +5.0V with 100mV
- Maximum Output Current : 300 mA
- Dropout Voltage : 120mV @ 100mA
- Low Current Consumption 15 μ A (Typ.)
- Shutdown Current : 0.1 μ A (Typ.)
- \pm 2% Output Voltage Accuracy (special \pm 1% highly accurate)
- Low ESR Capacitor Compatible
- High Ripple Rejection : 70 dB
- Output Current Limit Protection (450mA)
- Short Circuit Protection (150mA)
- Thermal Overload Shutdown Protection
- Control Output ON/OFF Function
- SOT23-5L、UFN-6 and TSOT23-5 packages.
- Green (Halogen Free With Commercial Standard)

Application

- Battery-Powered Devices.
- Personal Communication Devices.
- Mobile Phones, Cordless Phone.
- Portable Games.
- Portable AV equipment.

300mA Linear Regulator with Enable And Fast Discharge Function

Block Diagram

EC49513A Function Block Diagram

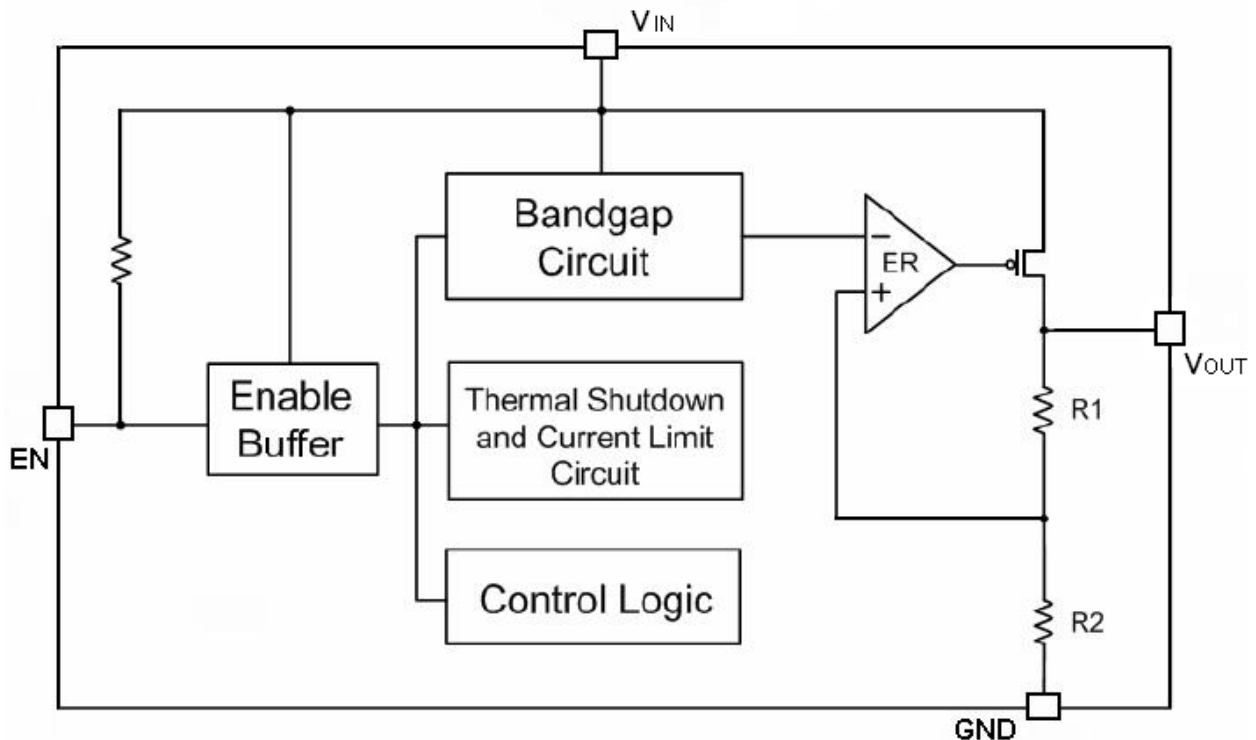

EC49513L Function Block Diagram

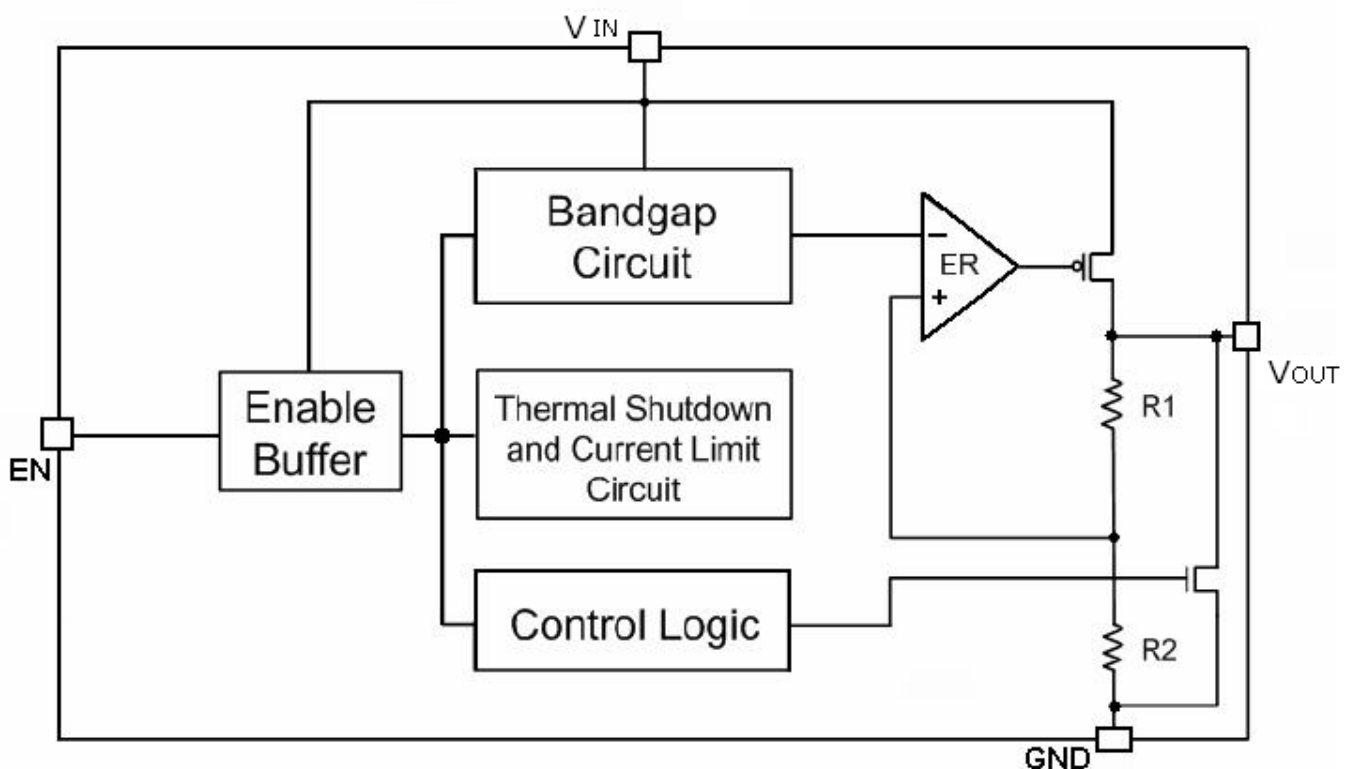

300mA Linear Regulator with Enable And Fast Discharge Function

Pin Assignment

SOT23-5L/TSOT23-5L
(Top View)

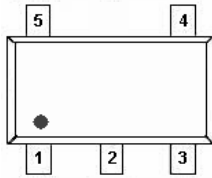

UFN-6
(Bottom View)

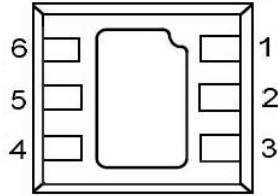

Pin Descriptions

Pin# SOT23-5L/TSOT23-5L	Pin# UFN-6	Symbol	Function
1	1	V _{IN}	Power Input.
2	5	GND	Ground Pin.
3	6	EN	Chip Enable Pin.
4	2,4	NC	No Connection.
5	3	V _{OUT}	Voltage Output Pin.

Ordering Information

EC49513X - XXX XX X

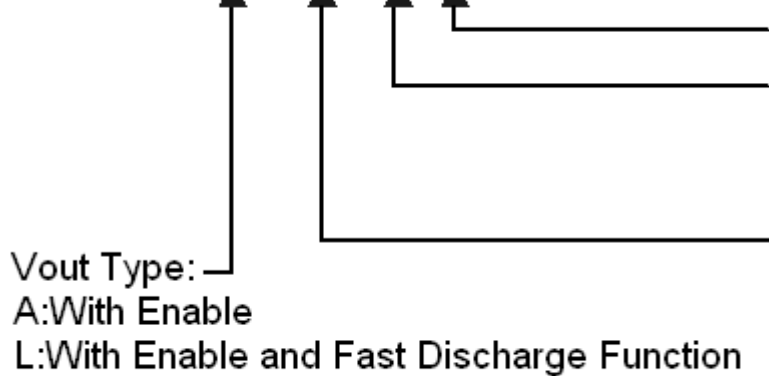

G:Green Mode

Package Type:B2=SOT23-5L

F=UFN-6

T2=TSOT23-5

Vout Code:

12=1.2V, 15=1.5V, 18=1.8V

25=2.5V, 27=2.7V, 28=2.8V

285=2.85V, 30=3.0V, 33=3.3V

36=3.6V, 42=4.2V,

Package	Part Number	Information
SOT23-5L	EC49513A-XXXB2G	The XXX character represents Output Voltage. Example: 12=1.2V, 15=1.5V...
	EC49513L-XXXB2G	
UFN-6	EC49513A-XXXFG	
	EC49513L-XXXFG	
TSOT23-5	EC49513A-XXXT2G	
	EC49513L-XXXT2G	



300mA Linear Regulator with Enable And Fast Discharge Function

Marking Information

Package	Part Number	Marking	Marking Information
SOT23-5L	EC49513A-XXXB2G	3AVXX	<p>The 1st to 2nd character represents the V_{OUT} Type. 3A: With Enable, 3L: With Enable and Fast Discharge Function.</p> <p>The 3rd character represents the Output Voltage code. Please refer the table for Output Voltage Code information.</p> <p>The XX characters represents the Date Code</p> <p>There are under-lines on 4th and 5th character for Green package.</p> <p>There are no under lines on second lines of 1st and 2nd characters for Lead Free package.</p>
	EC49513L-XXXB2G	3LVXX	
UFN-6	EC49513A-XXXFG	3AV XX	<p>The 1st to 2nd character represents the V_{OUT} Type. 3A: With Enable, 3L: With Enable and Fast Discharge Function.</p> <p>The 3rd character represents the Output Voltage code. Please refer the table for Output Voltage Code information.</p> <p>The XX characters represents the Date Code</p> <p>There are under-lines on 4th and 5th character for Green package.</p> <p>There are no under lines on second lines of 1st and 2nd characters for Lead Free package.</p>
	EC49513L-XXXFG	3LV XX	
TSOT23-5	EC49513A-XXXT2G	3AVXX	<p>The 1st to 2nd character represents the V_{OUT} Type. 3A: With Enable, 3L: With Enable and Fast Discharge Function.</p> <p>The 3rd character represents the Output Voltage code. Please refer the table for Output Voltage Code information.</p> <p>The XX characters represents the Date Code.</p> <p>There is an under-line on 1st digit for SOT23-5 package.</p> <p>There is an under-line on 2nd digit for TSOT25 package</p> <p>There are under-lines on 4th and 5th character for Green package.</p> <p>There are no under lines on second lines of 1st and 2nd characters for Lead Free package.</p>
	EC49513L-XXXT2G	3LVXX	



300mA Linear Regulator with Enable And Fast Discharge Function

Table1

Mark code vs. Output Voltage code of Products part

Part Number	Mark	Part Number	Mark	Part Number	Mark
EC49513A/L-12B2G	5	EC49513A/L-28B2G	K	EC49513A/L-42B2G	S
EC49513A/L-12FG		EC49513A/L-28FG		EC49513A/L-42FG	
EC49513A/L-12T2G		EC49513A/L-28T2G		EC49513A/L-42T2G	
EC49513A/L-15B2G	8	EC49513A/L-285B2G	L		
EC49513A/L-15FG		EC49513A/L-285FG			
EC49513A/L-15T2G		EC49513A/L-285T2G			
EC49513A/L-18B2G	A	EC49513A/L-30B2G	M		
EC49513A/L-18FG		EC49513A/L-30FG			
EC49513A/L-18T2G		EC49513A/L-30T2G			
EC49513A/L-25B2G	G	EC49513A/L-33B2G	Q		
EC49513A/L-25FG		EC49513A/L-33FG			
EC49513A/L-25T2G		EC49513A/L-33T2G			
EC49513A/L-27B2G	J	EC49513A/L-36B2G	V		
EC49513A/L-27FG		EC49513A/L-36FG			
EC49513A/L-27T2G		EC49513A/L-36T2G			

Absolute Maximum Ratings

Parameter	Symbol	Value	Units
Input Voltage V_{IN} to GND	V_{IN}	7.0	V
Output Current Limit, $I_{(LIMIT)}$	I_{OUT}	0.5	A
Junction Temperature	T_J	+155	°C
Thermal Resistance (SOT23-5L)	Θ_{JA}	250	°C/W
Power Dissipation	SOT23-5L	400	mW
	UFN-6	500	
Operating Ambient Temperature	T_{OPR}	-40 to +125	°C
Storage Temperature	T_{STG}	-55 to +150	°C
Lead Temperature (Soldering, 10sec.)	—	+260	°C

Note:

*The power dissipation of values are based on the condition that junction temperature T_J and ambient temperature T_A difference is 100°C

*Stresses beyond those listed under "absolute maximum ratings" may cause permanent damage to the device. These are stress ratings only, and function operation of the device at these to any other conditions beyond those indicated under "recommended operating conditions" is not implied. Exposure to absolute-maximum rated conditions for extended periods may affect device reliability.

* The power dissipation of UFN-6 would be 500 mW normally with the 0.5X0.5 square inches cooper area connected to the bottom pad. However, it could be up to 1000mW with larger cooper area.



300mA Linear Regulator with Enable And Fast Discharge Function

Electrical Characteristics

($V_{IN}=5V$, $T_A=25^{\circ}C$, unless otherwise noted.)

Symbol	Parameter	Test Conditions	Min	Typ	Max	Unit
V_{IN}	Input Voltage	—	2.2	—	7.0	V
V_{OUT}	Output Voltage	$V_{IN}=V_{OUT}+0.8V$	-1% -2%	V_{OUT}	+1% +2%	V
I_{MAX}	Output Current (see note *1)	$V_{OUT} + 0.8V \leq V_{IN} \leq 7.0V$, $2.2V \leq V_{IN}$	300	—	—	mA
V_{DROP}	Dropout Voltage	$I_{OUT}=300mA, 2.8V \leq V_{IN}, 25^{\circ}C \leq T_A \leq 80^{\circ}C$	—	550	650	mV
		$I_{OUT}=180mA, 2.8V \leq V_{IN}$	—	240	280	
		$I_{OUT}=150mA, 2.8V \leq V_{IN}$	—	160	180	
ΔV_{LINE}	Line Regulation	$V_{OUT} + 0.5V \leq V_{IN} \leq 7.0V$, $I_{OUT} = 1mA$	—	0.2	0.3	%V
		$V_{OUT}+0.15V \leq V_{IN} \leq 5.0V, I_{OUT} 1mA$, $V_{IN} \geq 2.8V$	—	—	0.2	
ΔV_{LOAD}	Load Regulation	$V_{IN} = V_{OUT} + 1V$, $1mA \leq I_{OUT} \leq 100mA$	—	0.01	0.02	%/mA
I_Q	Ground Pin Current	$V_{IN} = 5V$, $EN=5V$, No Load	—	15	30	μA
		$V_{IN} = 5V$, $EN=5V$, $I_{OUT} = 150mA$,	—	30	60	
I_{SD}	Shutdown Current	$V_{IN} = V_{OUT} + 1V$, $EN=0V$, No Load	—	0.1	1.0	μA
V_{IH}	EN Pin Input Voltage "H"	(See note *2, *4)	2.0	—	—	V
V_{IL}	EN Pin Input Voltage "L"	(See note *2)	—	—	0.3	V
I_{EN}	EN Pin Leakage Current	$V_{IN} = (V_{OUT} + 0.15V)$ to $5V$, $V_{EN} > V_{IH}$ (See note *3)	—	0.1	0.15	μA
I_{SC}	Short Circuit Current	—	—	150	—	mA
PSRR	Ripple Rejection Rate	$I_{OUT} = 30mA$, $F=1KHz$	—	70	—	dB
		$I_{OUT} = 30mA$, $F=10KHz$	—	65	—	
e_N	Output Noise	$I_{OUT} = 100mA$, $F=1KHz$, $C_{OUT}=10\mu A$	—	40	—	$\mu V_{(rms)}$
T_{SD}	Thermal Shutdown Temperature	—	—	150	—	$^{\circ}C$
T_{HYS}	Thermal Shutdown Hysteresis	—	—	20	—	$^{\circ}C$
R_{DIS}	Discharge Resistor	$V_{EN}=0V$, (See note *3)	—	30	100	Ω
T_{DIS}	Discharge Time	$V_{OUT}=3.3V$ to $0V$, $C_{OUT}=1\mu F$ (See note *3)	—	70	100	μS

Note:

*1) Measured using a double sided board with 1"x2" square inches of copper area connected to the GND pins for "heat spreading".

*2) EN pin input voltage must be always less than or equal to input voltage.

*3) It is for the EC49513L only.

300mA Linear Regulator with Enable And Fast Discharge Function

Typical Performance Characteristics

(1) Output Voltage vs. Output Current

EC49513A/L-18

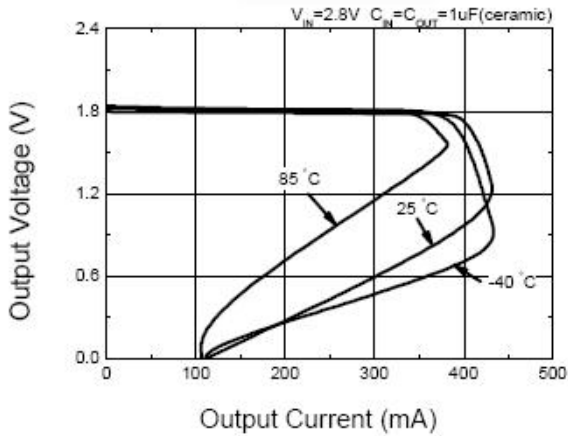

EC49513A/L-18

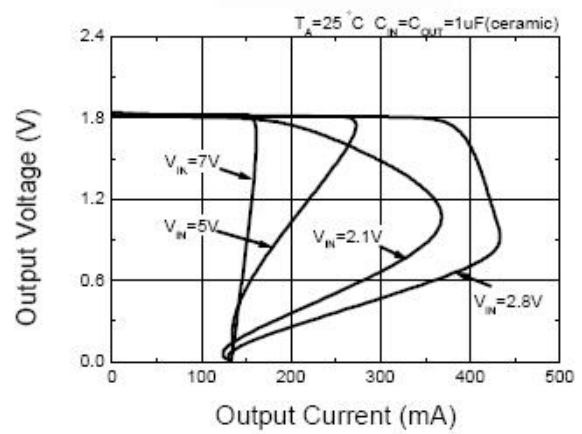

EC49513A/L-28

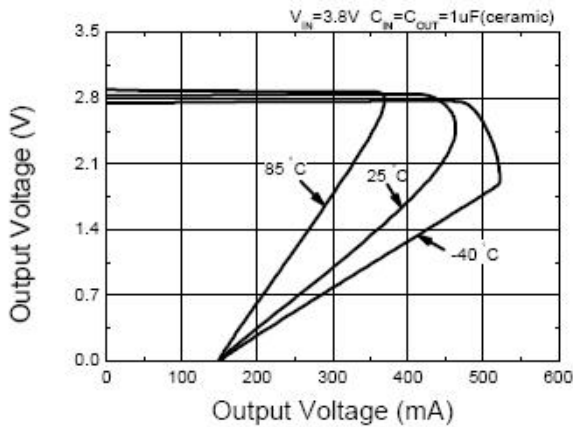

EC49513A/L-28

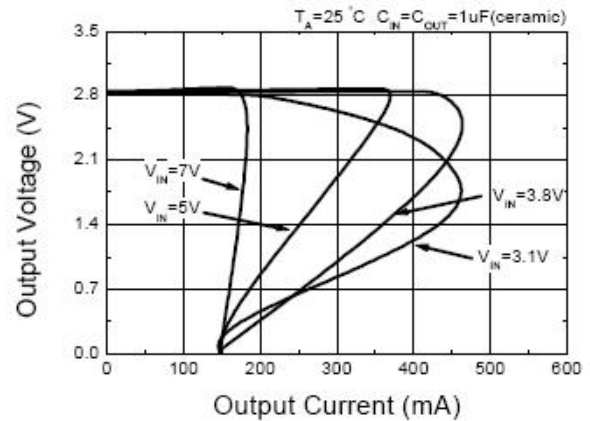

EC49513A/L-33

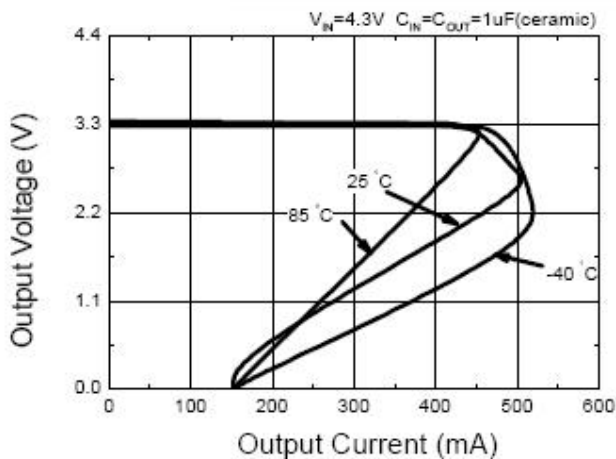

EC49513A/L-33

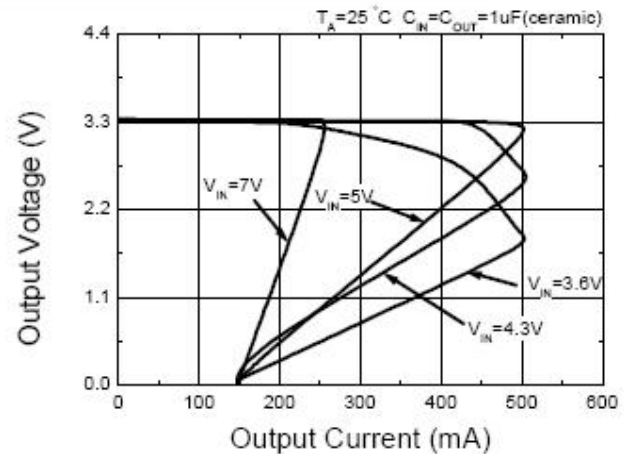

300mA Linear Regulator with Enable And Fast Discharge Function

Typical Performance Characteristics

(1) Output Voltage vs. Output Current (Continued)

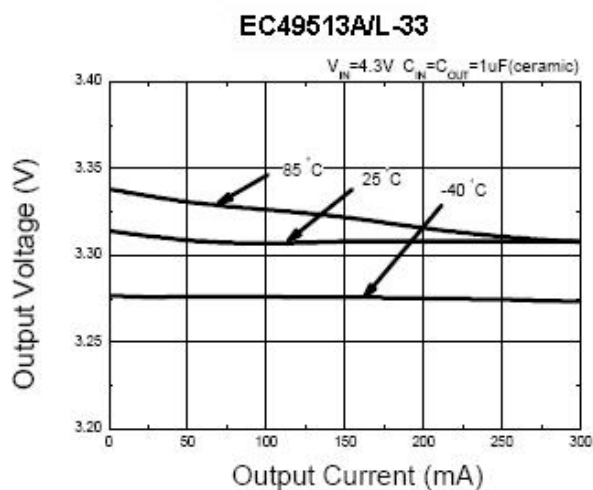
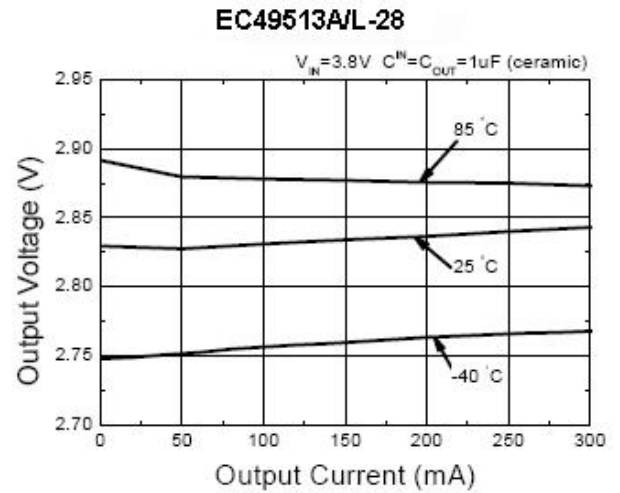
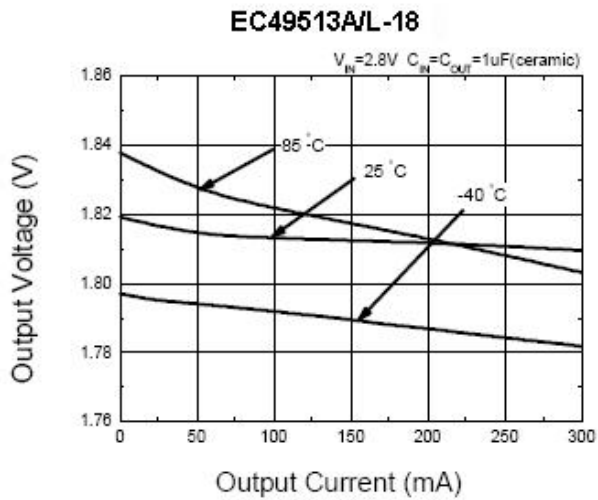

300mA Linear Regulator with Enable And Fast Discharge Function

Typical Performance Characteristics (Continued)

(2) Dropout Voltage vs. Output Current

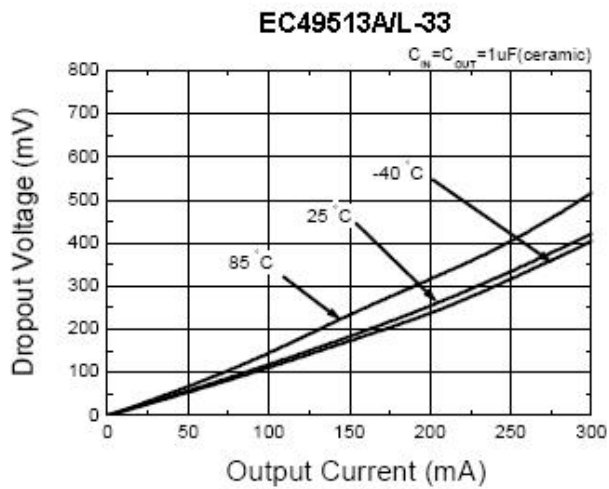
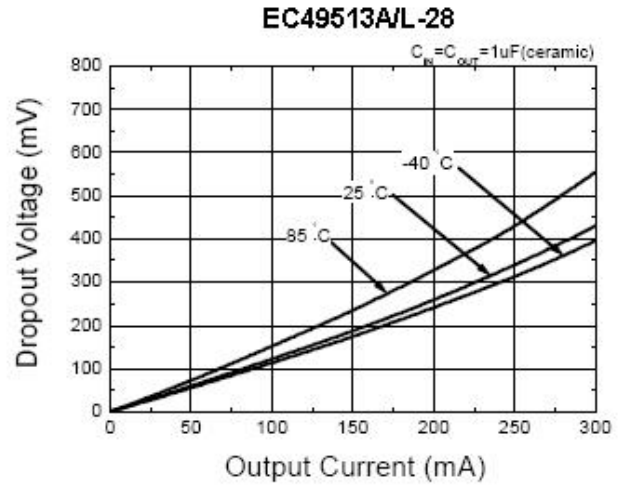
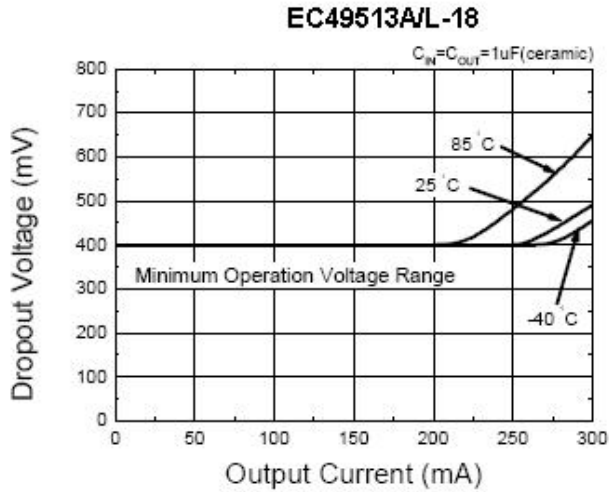

300mA Linear Regulator with Enable And Fast Discharge Function

Typical Performance Characteristics (Continued)

(3) Supply Current vs. Input Voltage

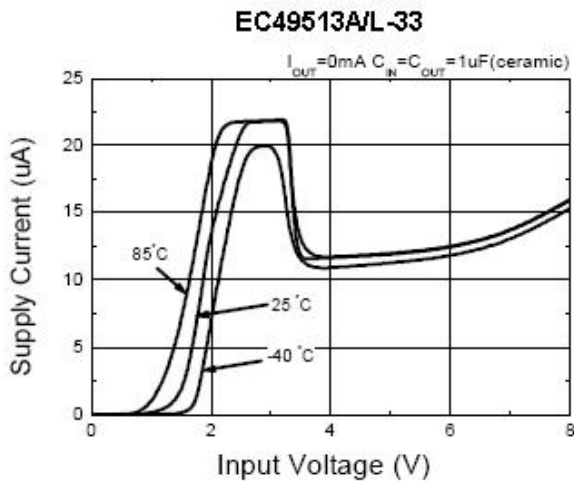
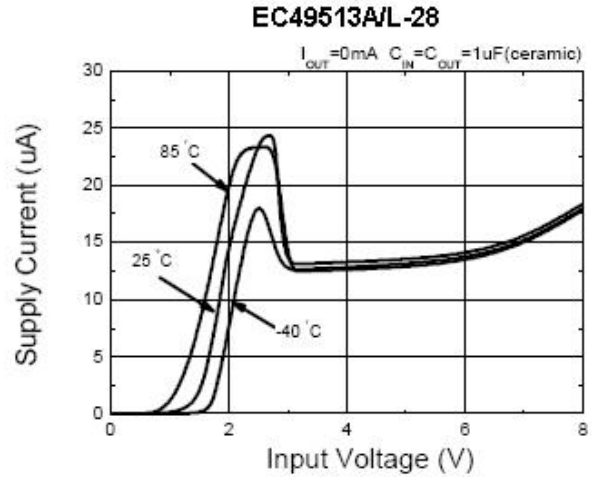
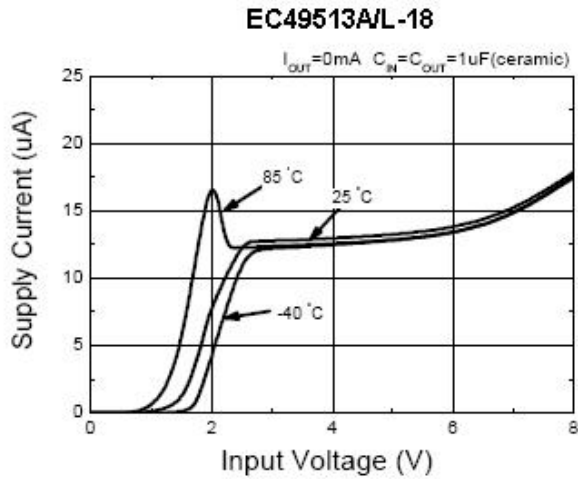

300mA Linear Regulator with Enable And Fast Discharge Function

Typical Performance Characteristics (Continued)

(4) Supply Current vs. Ambient Temperature

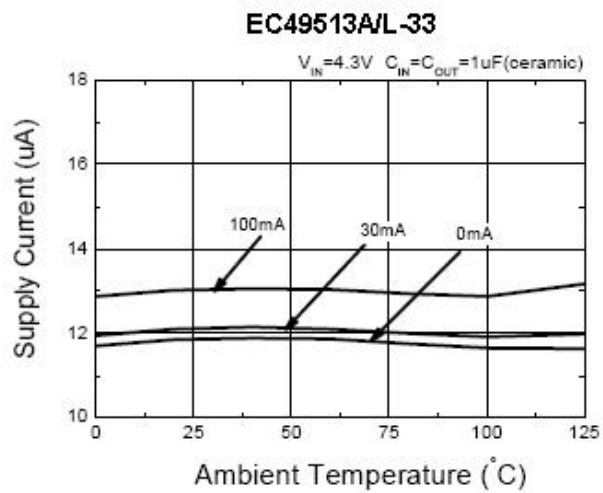
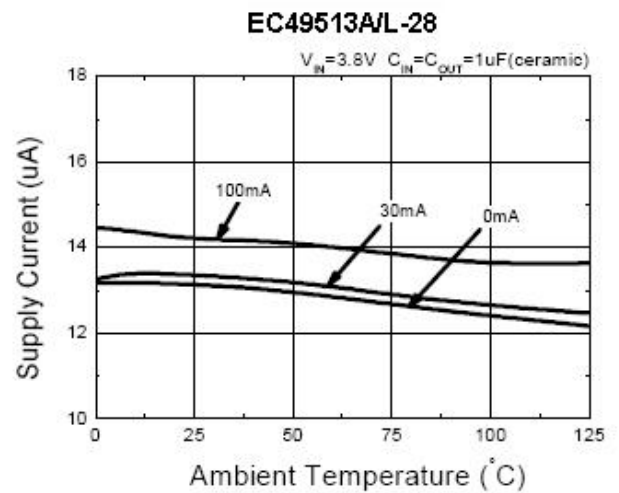
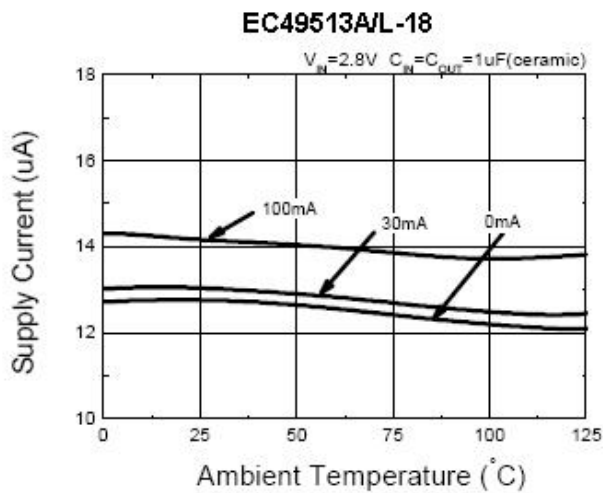

300mA Linear Regulator with Enable And Fast Discharge Function

Typical Performance Characteristics (Continued)

(5) Output Voltage vs. Ambient Temperature

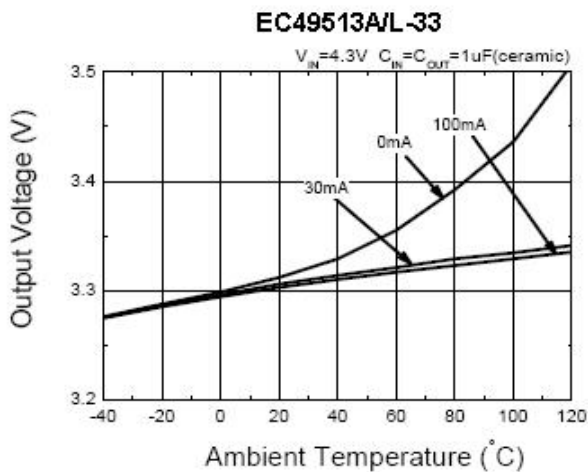
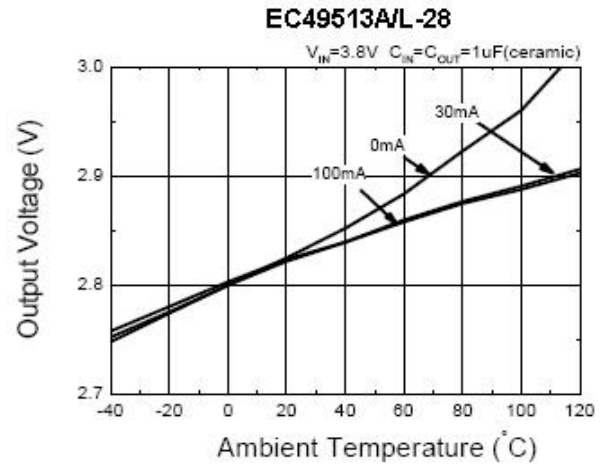
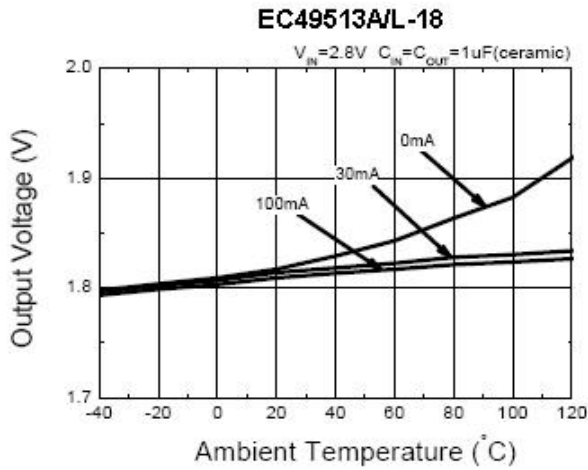

(6) Supply Current vs. Output Current

EC49513A/L

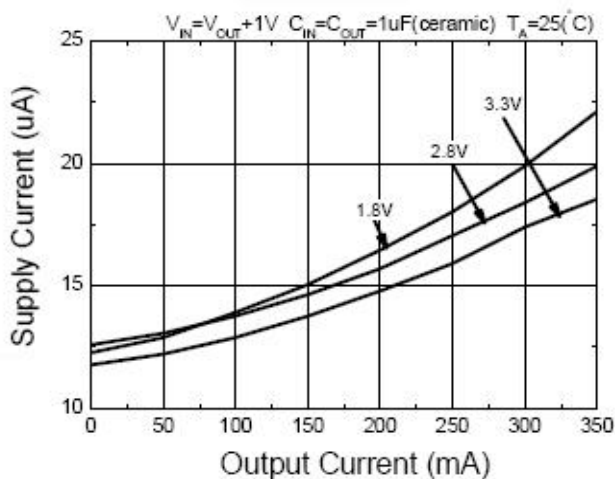



300mA Linear Regulator with Enable And Fast Discharge Function

Typical Performance Characteristics

(7) Output Voltage vs. Input Voltage

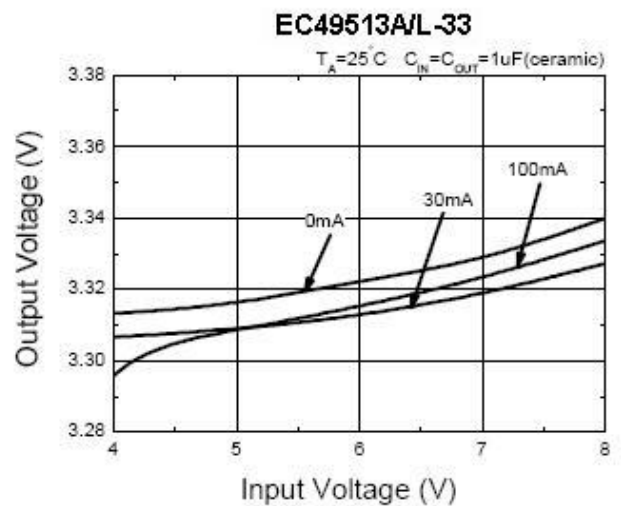
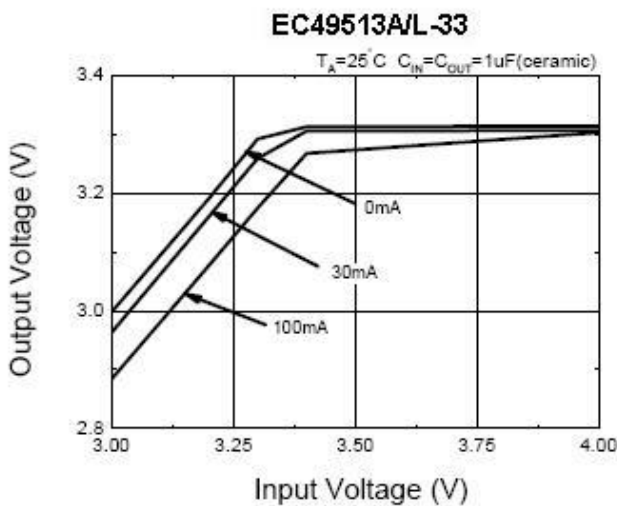
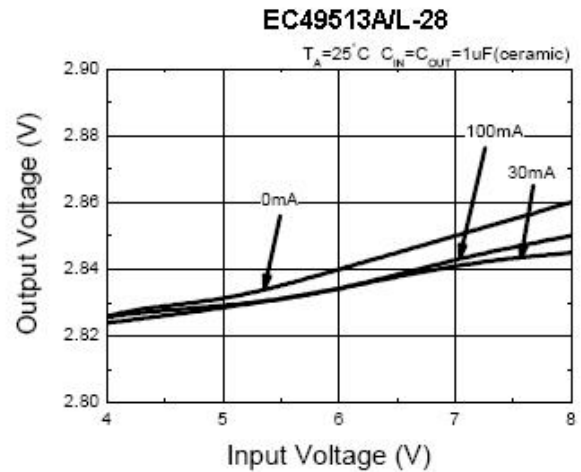
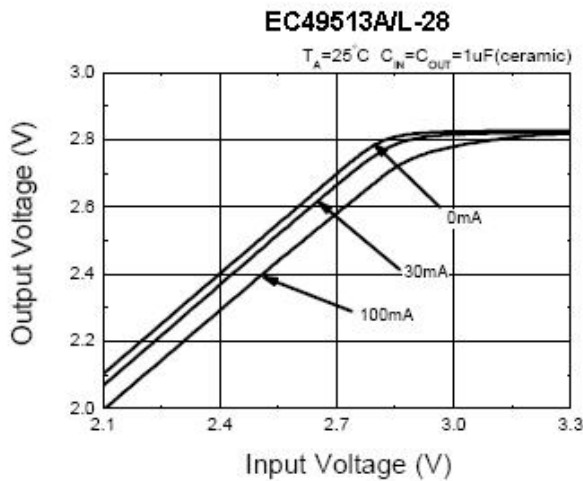
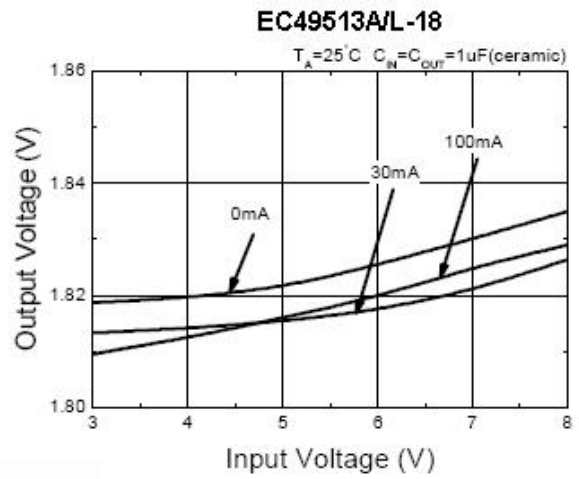
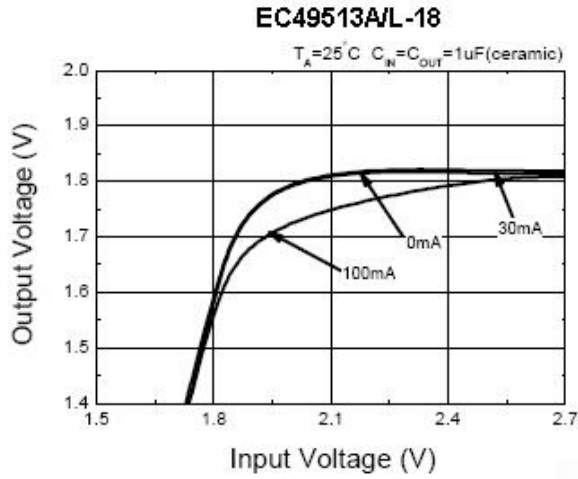



300mA Linear Regulator with Enable And Fast Discharge Function

Typical Performance Characteristics (Continued)

(8) Input Transient Response

EC49513A/L-18

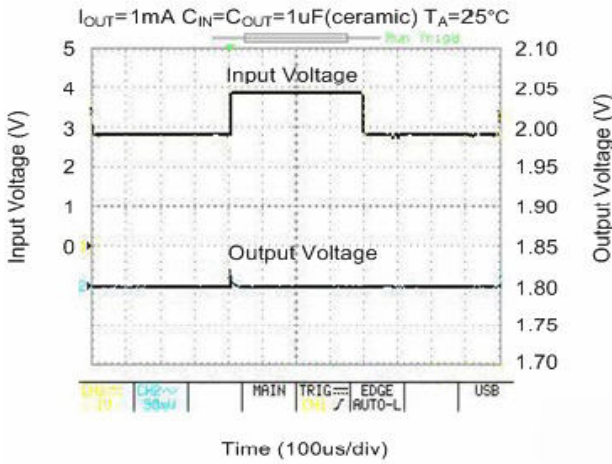

EC49513A/L-18

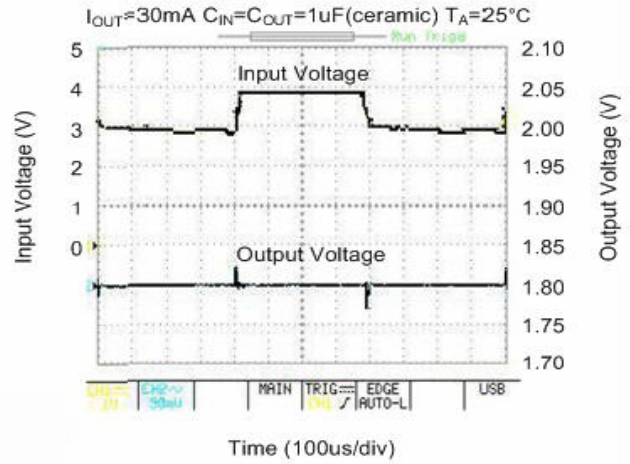

EC49513A/L-18

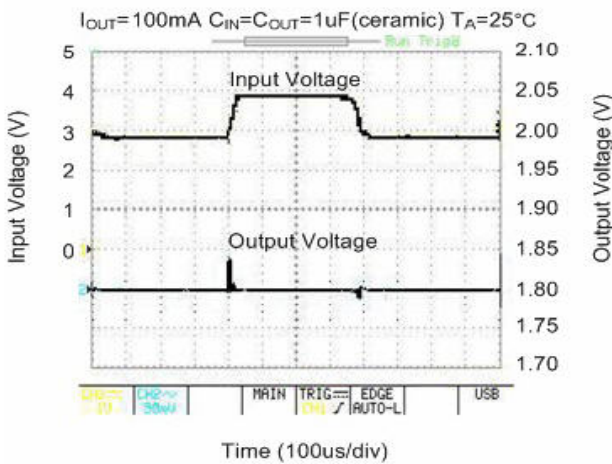

EC49513A/L-28

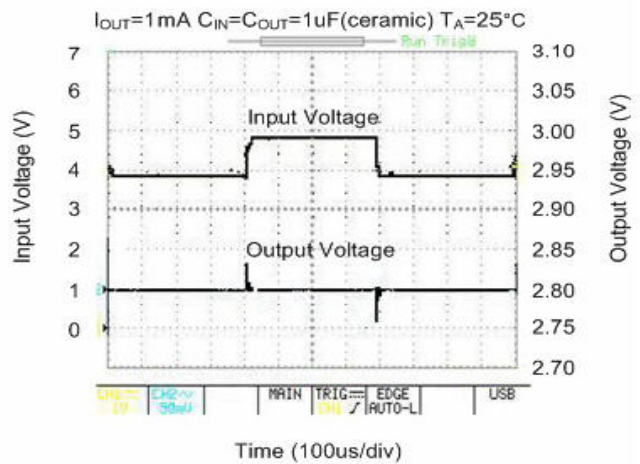

EC49513A/L-28

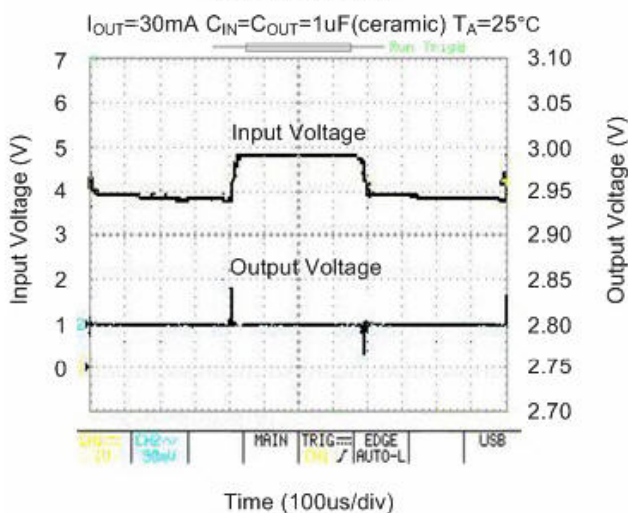

EC49513A/L-28

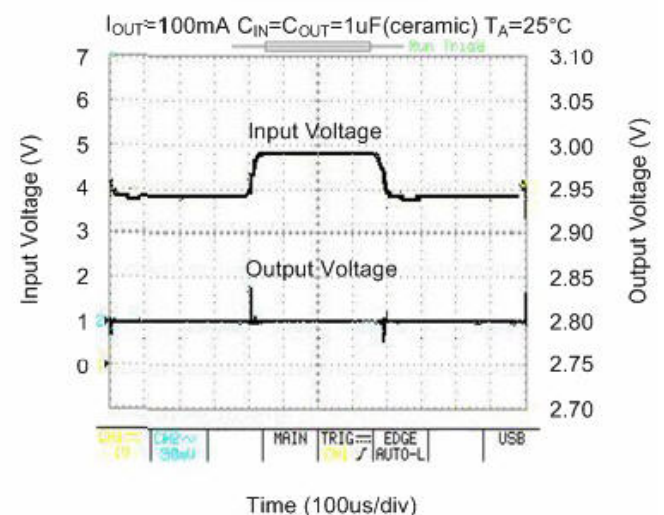

300mA Linear Regulator with Enable And Fast Discharge Function

Typical Performance Characteristics (Continued)

(8) Input Transient Response (Continued)

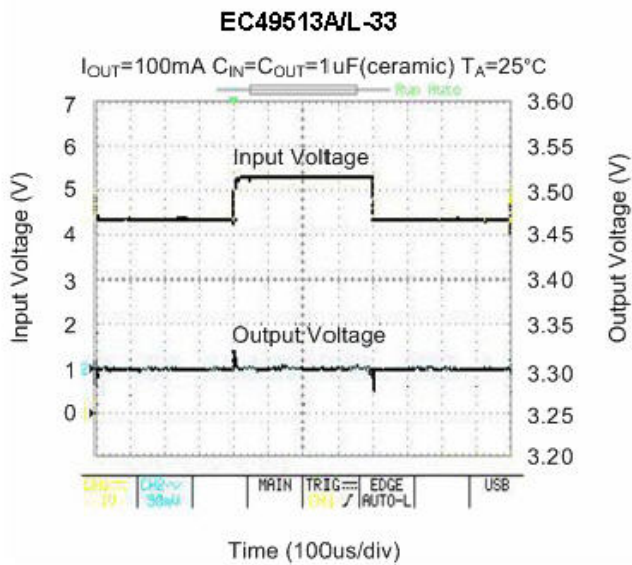
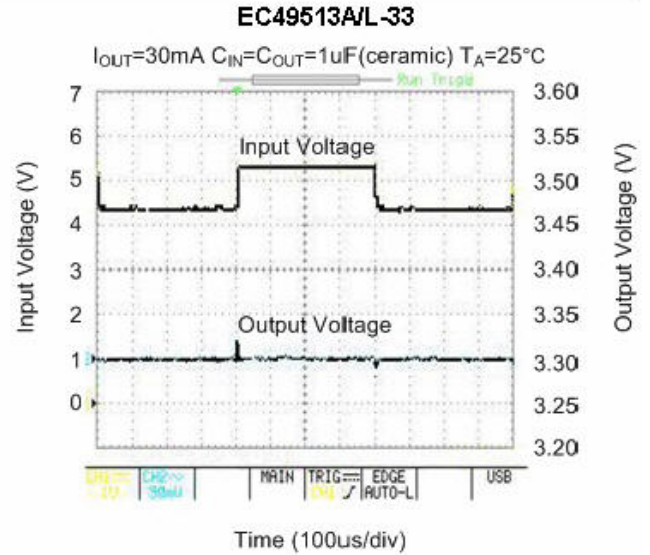
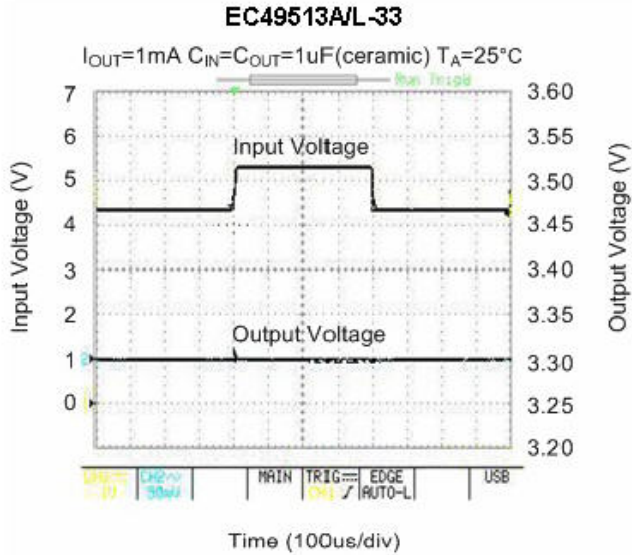

300mA Linear Regulator with Enable And Fast Discharge Function

Typical Performance Characteristics (Continued)

(9) Load Transient Response

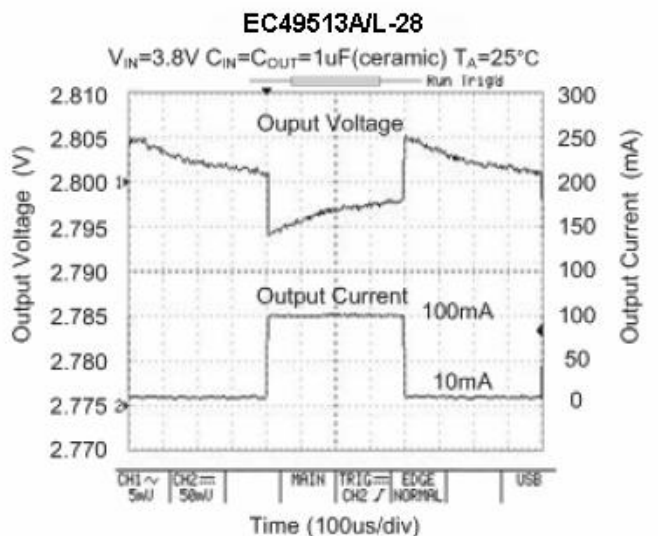
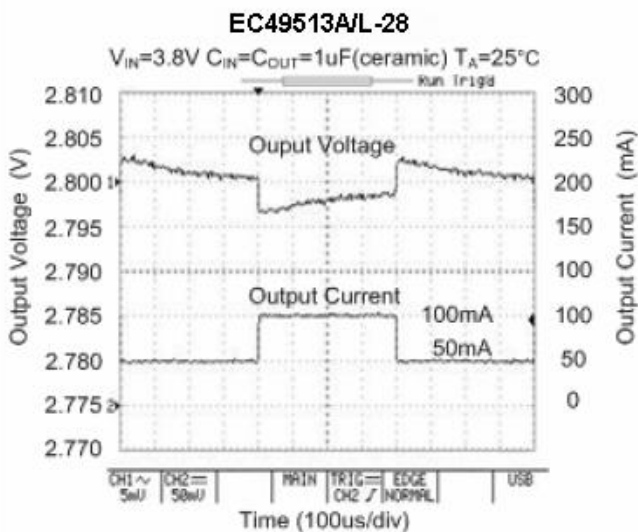
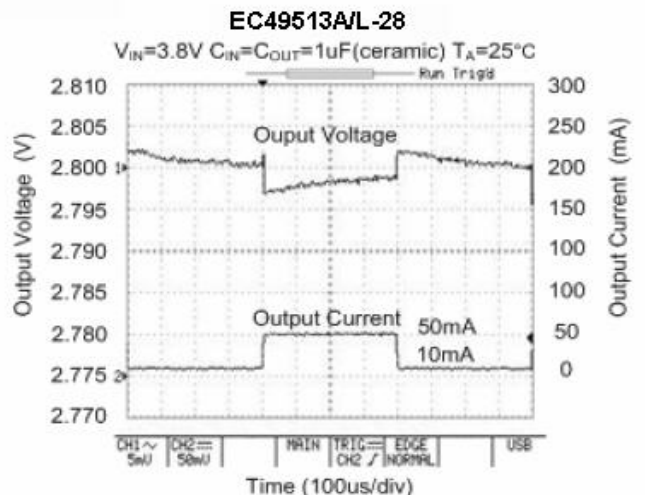
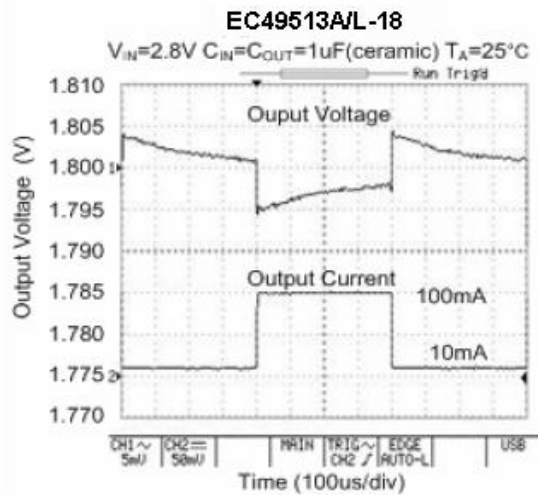
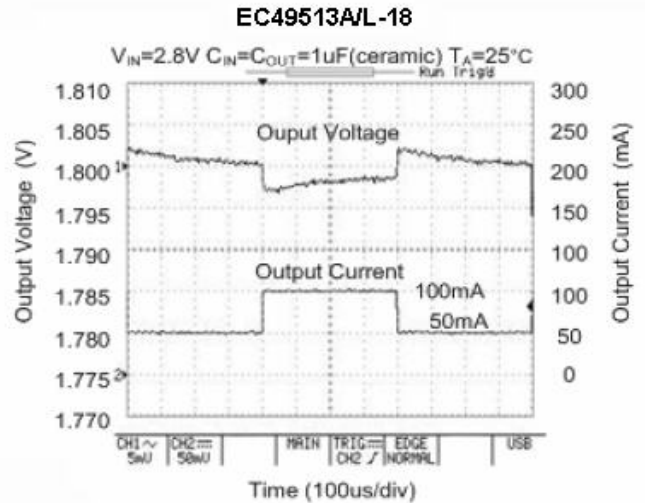
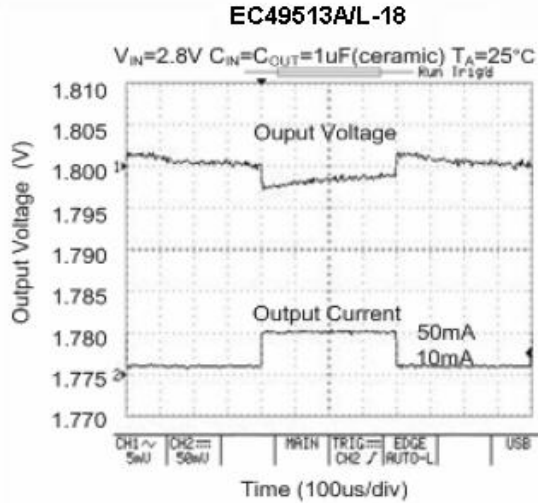

300mA Linear Regulator with Enable And Fast Discharge Function

Typical Performance Characteristics (Continued)

(9) Load Transient Response (Continued)

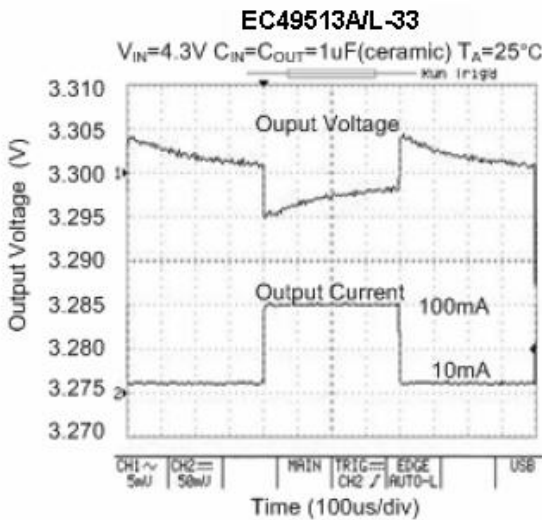
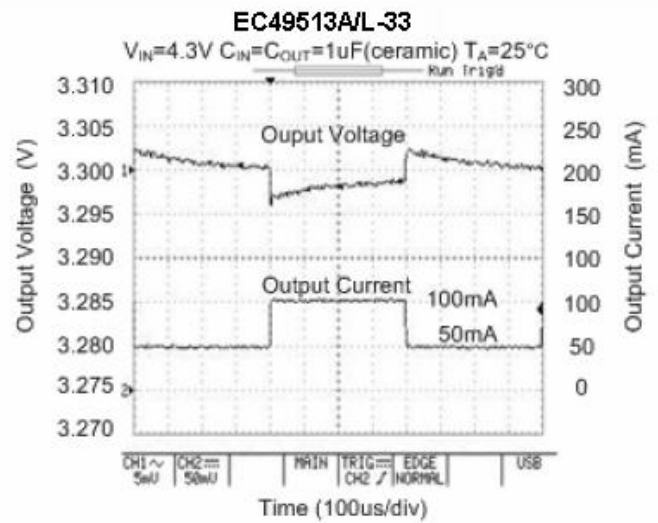
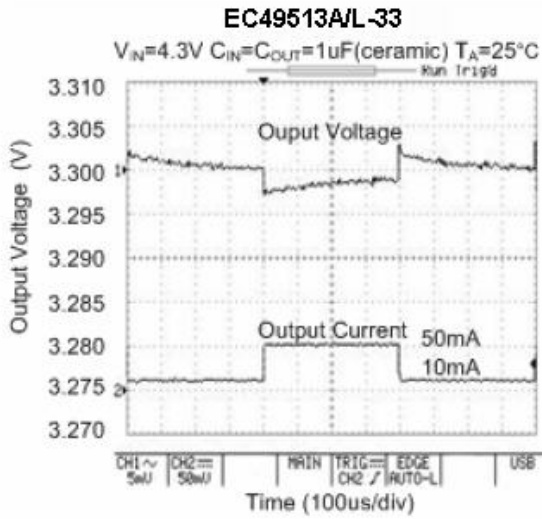

300mA Linear Regulator with Enable And Fast Discharge Function

Typical Performance Characteristics (Continued)

(10) Power Supply Rejection Ratio (EC49513A/L)

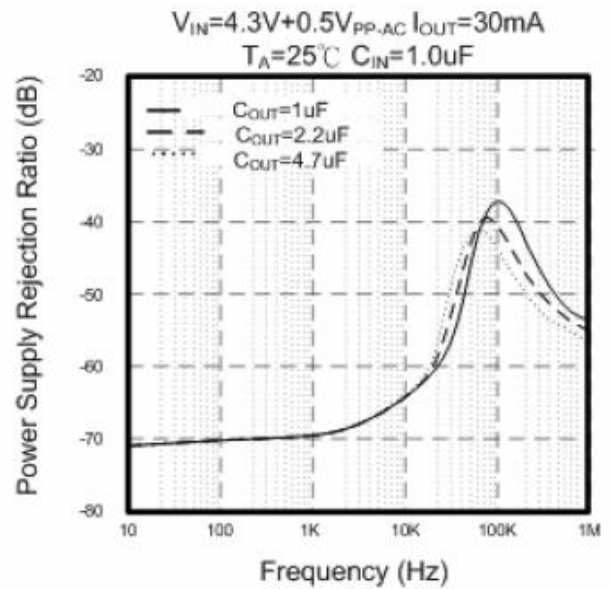
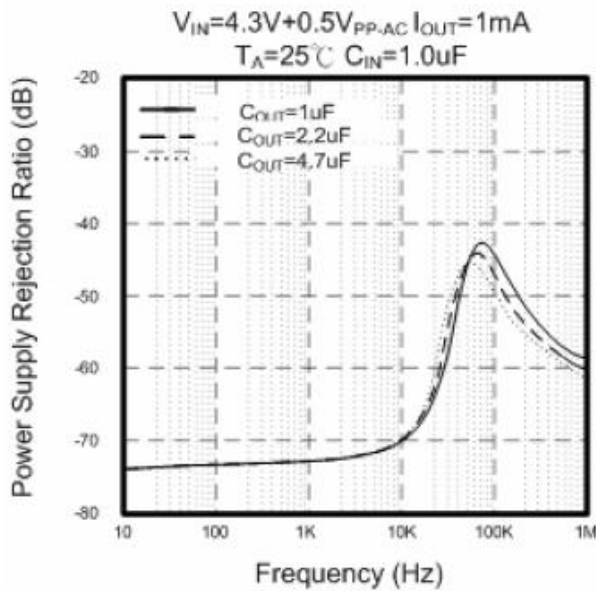

(11) Discharge Time vs. Output Capacitance (EC49513L only)

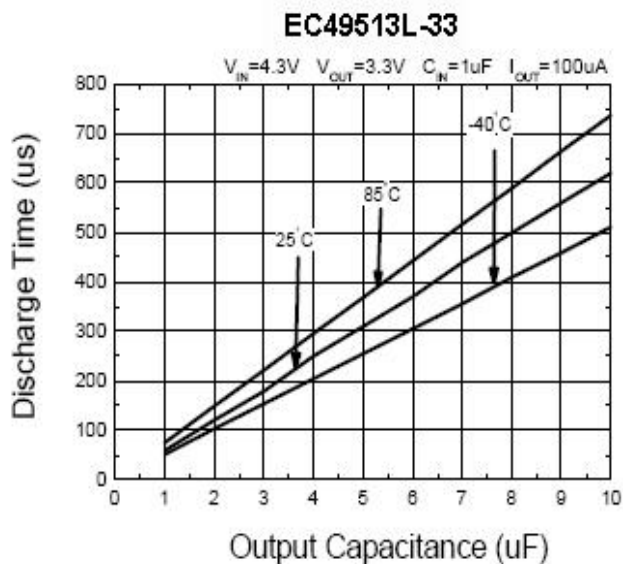

300mA Linear Regulator with Enable And Fast Discharge Function

Simplified Application Circuit

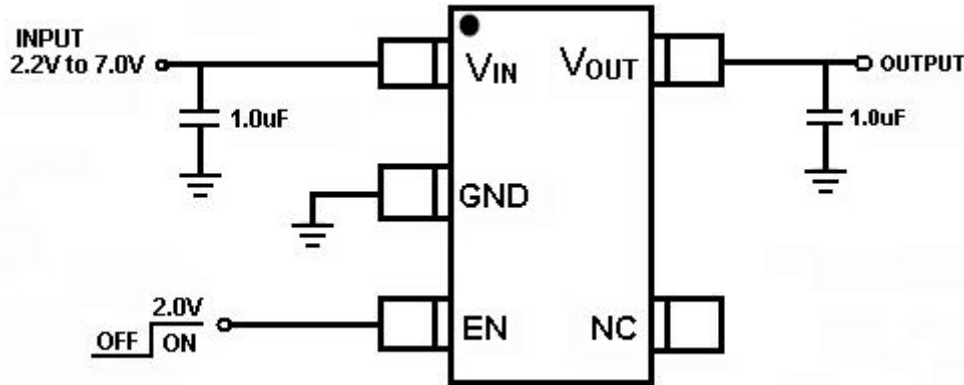

Detail Description

The EC49513A/L is a low dropout linear regulator. The device provides preset 2.5V, 2.85V and 3.3V output voltages for output current up to 300mA. Other mask options for special output voltages from 1.2V to 5.0V with 100mV increment are also available. As illustrated in function block diagram, it consists of a 1.0V reference, error amplifier, a P-channel pass transistor, an ON/OFF control logic and an internal feedback voltage divider.

The 1.0V band gap reference is connected to the error amplifier, which compares this reference with the feedback voltage and amplifies the voltage difference. If the feedback voltage is lower than the reference voltage, the pass-transistor gate is pulled lower, which allows more current to pass to the output pin and increases the output voltage. If the feedback voltage is too high, the pass transistor gate is pulled up to decrease the output voltage.

The output voltage is feed back through an internal resistive divider connected to V_{OUT} pin. Additional blocks include an output current limiter, thermal sensor, and shutdown logic.

Internal P-Channel Pass Transistor

The EC49513A/L features a P-channel MOSFET pass transistor. Unlike similar designs using PNP pass transistors, P-channel MOSFETs require no base drive, which reduces quiescent current. PNP based regulators also waste considerable current in dropout when the pass transistor saturates, and use high base-drive currents under large loads. The EC49513A/L does not suffer from these problems and consumes only 15 μ A (Typ.) of current consumption under heavy loads as well as in dropout conditions.

Enable Function

EN pin starts and stops the regulator. When the EN pin is switched to the power off level, the operation of all internal circuit stops, the build-in P-channel MOSFET output transistor between pins V_{IN} and V_{OUT} is switched off, allowing current consumption to be drastically reduced. The V_{OUT} Pin enters the GND level through the internal discharge path between V_{OUT} and GND pins.



300mA Linear Regulator with Enable And Fast Discharge Function

Fast Discharge Function

The EC49513L has fast discharge Function on EN pin disable. When user turns off EC49513L, its internal pull low resistor will discharge output capacitor charge. It'll avoid other device to arise wrong motions.

Output Voltage Selection

The EC49513A/L output voltage is preset at an internally trimmed voltage 2.5V, 2.85V or 3.3V. The output voltage also can be mask-optional from 1.2V to 5.0V with 100mV increment by special order. The first two digits of part number suffix identify the output voltage (see Ordering Information). For example, the EC49513A/L-33 has a preset 3.3V output voltage.

Current Limit

The EC49513A/L also includes a fold back current limiter. It monitors and controls the pass transistor's gate voltage, estimates the output current, and limits the output current within 0.5A.

Thermal Overload Protection

Thermal overload protection limits total power dissipation of EC49513A/L. When the junction temperature exceeds $T_J = +150^{\circ}\text{C}$, a thermal sensor turns off the pass transistor, allowing the IC to cool down. The thermal sensor turns the pass transistor on again after the junction temperature cools down by 20°C , resulting in a pulsed output during continuous thermal overload conditions.

Thermal overload protection is designed to protect the EC49513A/L in the event of fault conditions. For continuous operation, the absolute maximum operating junction temperature rating of $T_J = +125^{\circ}\text{C}$ should not be exceeded.

Operating Region and Power Dissipation

Maximum power dissipation of the EC49513A/L depends on the thermal resistance of the case and printed circuit board, the temperature difference between the die junction and ambient air, and the rate of airflow. The power dissipation across the devices is $P = I_{\text{OUT}} \times (V_{\text{IN}} - V_{\text{OUT}})$. The resulting maximum power dissipation is

$$P_{\text{MAX}} = \frac{(T_J - T_A)}{\theta_{\text{JC}} + \theta_{\text{CA}}} = \frac{(T_J - T_A)}{\theta_{\text{JA}}}$$

Where $(T_J - T_A)$ is the temperature difference between the EC49513A/L die junction and the surrounding air, θ_{JC} is the thermal resistance of the package chosen, and θ_{CA} is the thermal resistance through the printed circuit board, copper traces and other materials to the surrounding air. For better heat-sinking, the copper area should be equally shared between the V_{IN} , V_{OUT} , and GND pins.

The thermal resistance θ_{JA} of SOT23-5L package of EC49513A/L is $250^{\circ}\text{C}/\text{W}$. based on a maximum operating junction temperature 125°C with an ambient of 25°C , the maximum power dissipation will be:

$$P_{\text{MAX}} = \frac{(T_J - T_A)}{\theta_{\text{JC}} + \theta_{\text{CA}}} = \frac{(125 - 25)}{250} = 0.40\text{W}$$

Thermal characteristics were measured using a double sided board with 1"x 2" square inches of copper area connected to the GND pin for "heat spreading".



300mA Linear Regulator with Enable And Fast Discharge Function

Dropout Voltage

A regulator's minimum input output voltage differential, or dropout voltage, determines the lowest usable supply voltage. In battery powered systems, this will determine the useful end of life battery voltage. The EC49513A/L uses a P-channel MOSFET pass transistor, its dropout voltage is a function of drain-to-source on-resistance ($R_{DS(ON)}$) multiplied by the load current.

$$V_{DROPOUT} = V_{IN} - V_{OUT} = R_{DS(ON)} \times I_{out}$$

300mA Linear Regulator with Enable And Fast Discharge Function

Mechanical Dimensions
OUTLINE DRAWING SOT23-5L

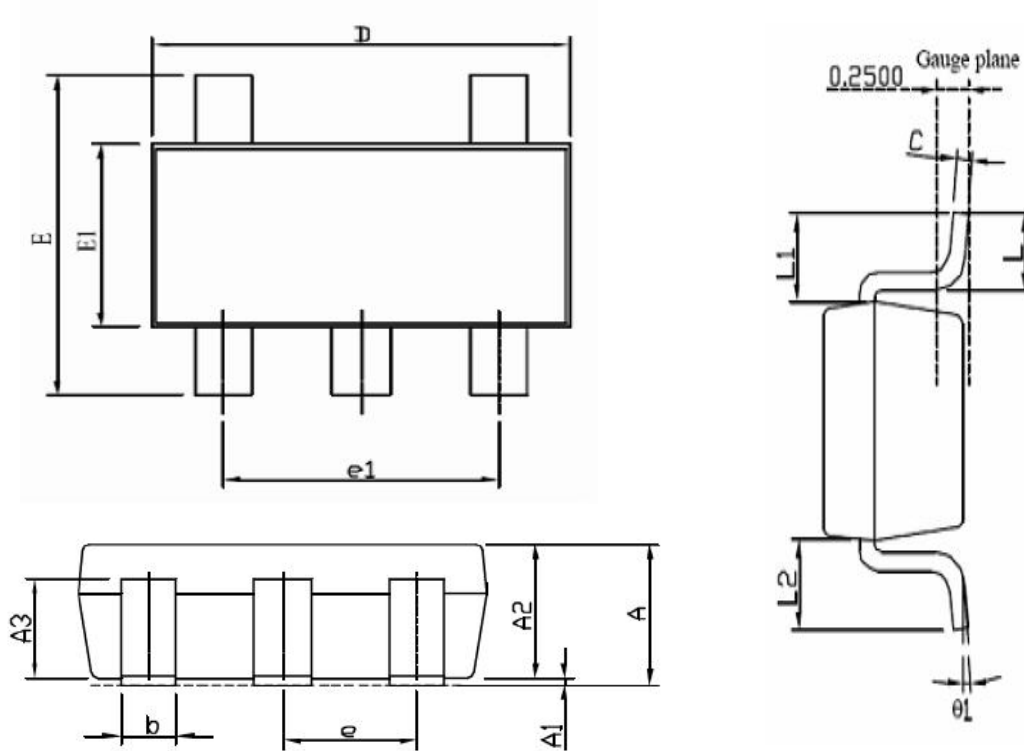

Symbols	Dimensions in Millimeters		
	Min	Nom	Max
A	1.00	1.10	1.40
A1	0.00	---	0.10
A2	1.00	1.10	1.30
A3	0.70	0.80	0.90
b	0.35	0.40	0.50
C	0.12	0.125	0.225
D	2.70	2.90	3.10
E1	1.40	1.60	1.80
e1	---	1.90(TYP)	---
E	2.60	2.80	3.00
L	0.37	---	---
$\theta 1$	1°	5°	9°
e	---	0.95(TYP)	---
L1	---	0.6(REF)	---
L1-L2	---	---	0.12

300mA Linear Regulator with Enable And Fast Discharge Function

Mechanical Dimensions
OUTLINE DRAWING UFN-6L

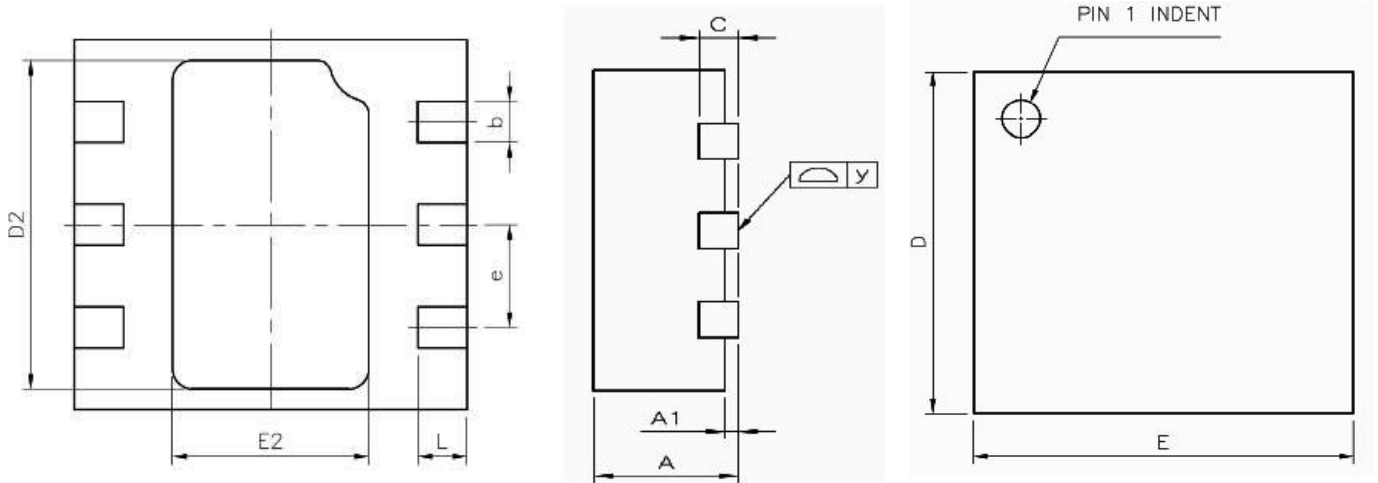

Dimension	mm		
	Min.	Nom.	Max.
A	0.50	0.55	0.60
A1	0.00	0.02	0.05
b	0.15	0.20	0.25
C	---	0.15 REF	---
D	1.60	1.80	1.90
D2	1.55	1.60	1.65
E	1.90	2.00	2.10
E2	0.95	1.00	1.05
e	---	0.50	---
L	0.20	0.25	0.30
y	0.00	---	0.075

300mA Linear Regulator with Enable And Fast Discharge Function

Mechanical Dimensions OUTLINE DRAWING TSOT23-5

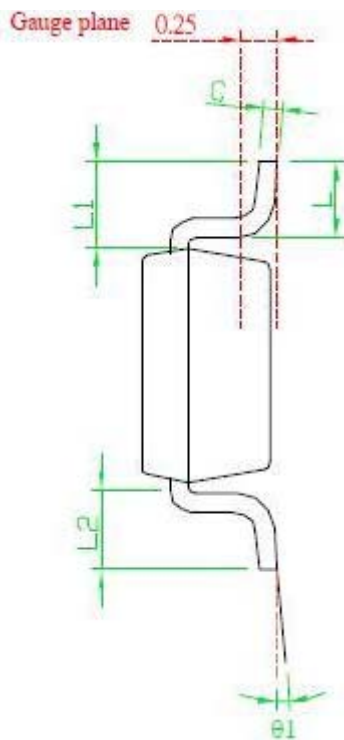
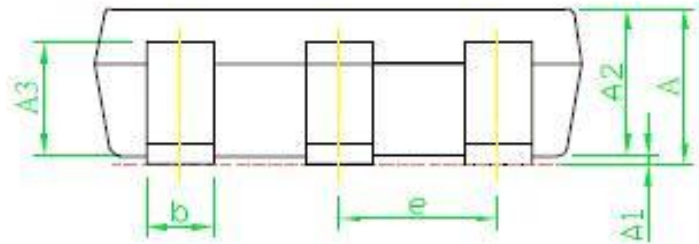
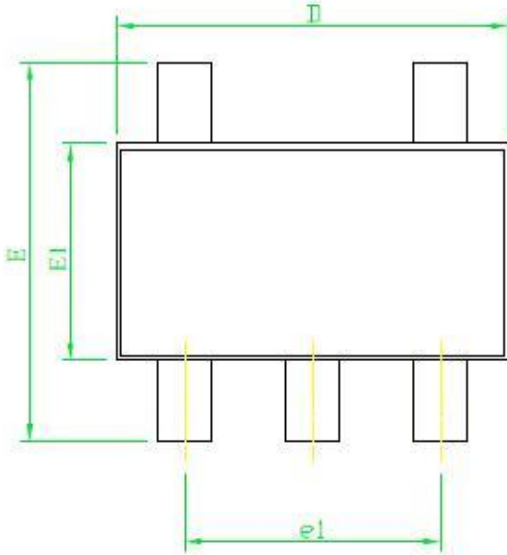

SYMBOL	Dimensions in Millimeters		
	MIN	NOM	MAX
A	-		1.00
A1	0.00	0.05	0.10
A2	0.84	0.87	0.90
A3	0.58	0.68	0.78
b	0.35	0.40	0.50
C	0.10	0.125	0.15
D	2.70	2.90	3.10
E1	1.40	1.60	1.80
e1	-	1.90(TYP)	-
E	2.60	2.80	3.00
e	-	0.95(TYP)	-
$\theta 1$	1°	5°	9°
L	0.37	-	-
L1	-	0.6REF	-
L1-L2	-	-	0.12