

Protection Device

TVS (Transient Voltage Suppressor)

ESD231-B1-W0201

Bi-directional, 5.5 V, 3.5 pF, 0201, RoHS and Halogen Free compliant

ESD231-B1-W0201

Data Sheet

Revision 1.1, 2015-10-02
Final

Edition 2015-10-02

Published by

Infineon Technologies AG

81726 Munich, Germany

© 2015 Infineon Technologies AG

All Rights Reserved.

Information

For further information on technology, delivery terms and conditions and prices, please contact the nearest Infineon Technologies Office (www.infineon.com)

Warnings

Due to technical requirements, components may contain dangerous substances. For information on the types in question, please contact the nearest Infineon Technologies Office.

Infineon Technologies components may be used in life-support devices or systems only with the express written approval of Infineon Technologies, if a failure of such components can reasonably be expected to cause the failure of that life-support device or system or to affect the safety or effectiveness of that device or system. Life support devices or systems are intended to be implanted in the human body or to support and/or maintain and sustain and/or protect human life. If they fail, it is reasonable to assume that the health of the user or other persons may be endangered.

1 Product Overview

1.1 Features

- ESD / transient protection of susceptible I/O lines to:
 - IEC61000-4-2 (ESD): ± 30 kV (air/contact discharge)
 - IEC61000-4-4 (EFT): ± 4 kV / ± 80 A(5/50 ns)
 - IEC61000-4-5 (surge): ± 12 A (8/20 μ s)
- Bi-directional working voltage up to: $V_{RWM} = \pm 5.5$ V
- Line capacitance: $C_L = 3.5$ pF (typical) at $f = 1$ MHz
- Clamping voltage: $V_{CL} = 12$ V (typical) at $I_{TLP} = 16$ A with $R_{DYN} = 0.3$ Ω (typical)
- Very low reverse current. $I_R < 1$ nA (typical)
- Minimized clamping overshoot due to extremely low parasitic inductance
- Small form factor SMD Size 0201 and low profile (0.58 mm x 0.28 mm x 0.15 mm)
- Bidirectional and symmetric I/V characteristics for optimized design and assembly
- Pb-free (RoHS compliant) and halogen free package



Guidelines for optimized PCB design and assembly process available [\[2\]](#)



1.2 Application Examples

- USB 2.0 HA, MIPI, (μ)SD-card (UHS), SIM-card
- Control ports for DVI, HDMI, Display Port, and Thunderbolt
- Audio Line, Speaker, Headset, Microphone Protection
- Human Interface Devices (Keyboard, Touchpad, Buttons)

1.3 Product Description

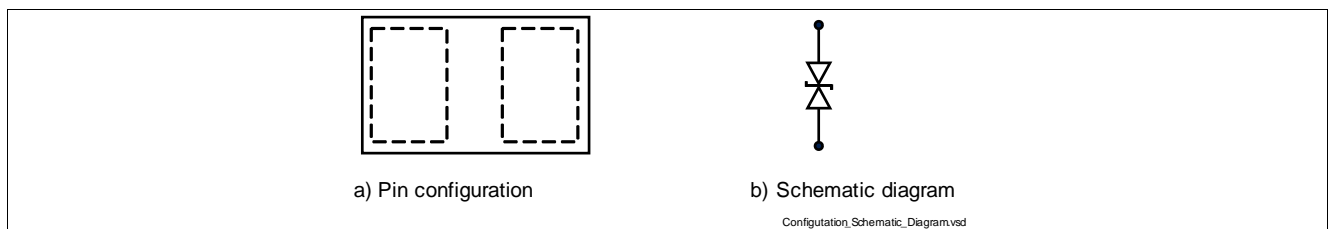

Figure 1-1 Pin Configuration and Schematic Diagram

Table 1-1 Part Information

Type	Package	Configuration	Marking code
ESD231-B1-W0201	WLL-2-1	1 line, bi-directional	M ¹⁾

1) The device does not have any marking or date code on the device backside. The Marking code is on pad side.

2 Maximum Ratings

Table 2-1 Maximum Rating at $T_A = 25\text{ °C}$, unless otherwise specified¹⁾

Parameter	Symbol	Values			Unit
		Min.	Typ.	Max.	
Reverse working voltage	V_{RWM}		±5.5		V
ESD air discharge ²⁾	V_{ESD}		±30		kV
ESD contact discharge ²⁾			±30		
Peak pulse power ³⁾	P_{PK}		132		W
Peak pulse current ³⁾	I_{PP}		12		A
Operating temperature	T_{OP}	-55		125	°C
Storage temperature	T_{stg}	-65		150	°C

1) Device is electrically symmetrical

2) V_{ESD} according to IEC61000-4-2

3) Stress pulse: 8/20µs current waveform according to IEC61000-4-5

Attention: Stresses above the max. values listed here may cause permanent damage to the device. Exposure to absolute maximum rating conditions for extended periods may affect device reliability. Maximum ratings are absolute ratings; exceeding only one of these values may cause irreversible damage to the component.

Table 2-2 Thermal Resistance

Parameter	Symbol	Values			Unit
		Min.	Typ.	Max.	
Junction - soldering point ¹⁾	R_{thJS}	-	30		K/W

1) For calculation of R_{thJA} please refer to Application Note [3] 077 Thermal Resistance Calculation.

Electrical Characteristics at $T_A = 25\text{ }^\circ\text{C}$, unless otherwise specified

3 Electrical Characteristics at $T_A = 25\text{ }^\circ\text{C}$, unless otherwise specified

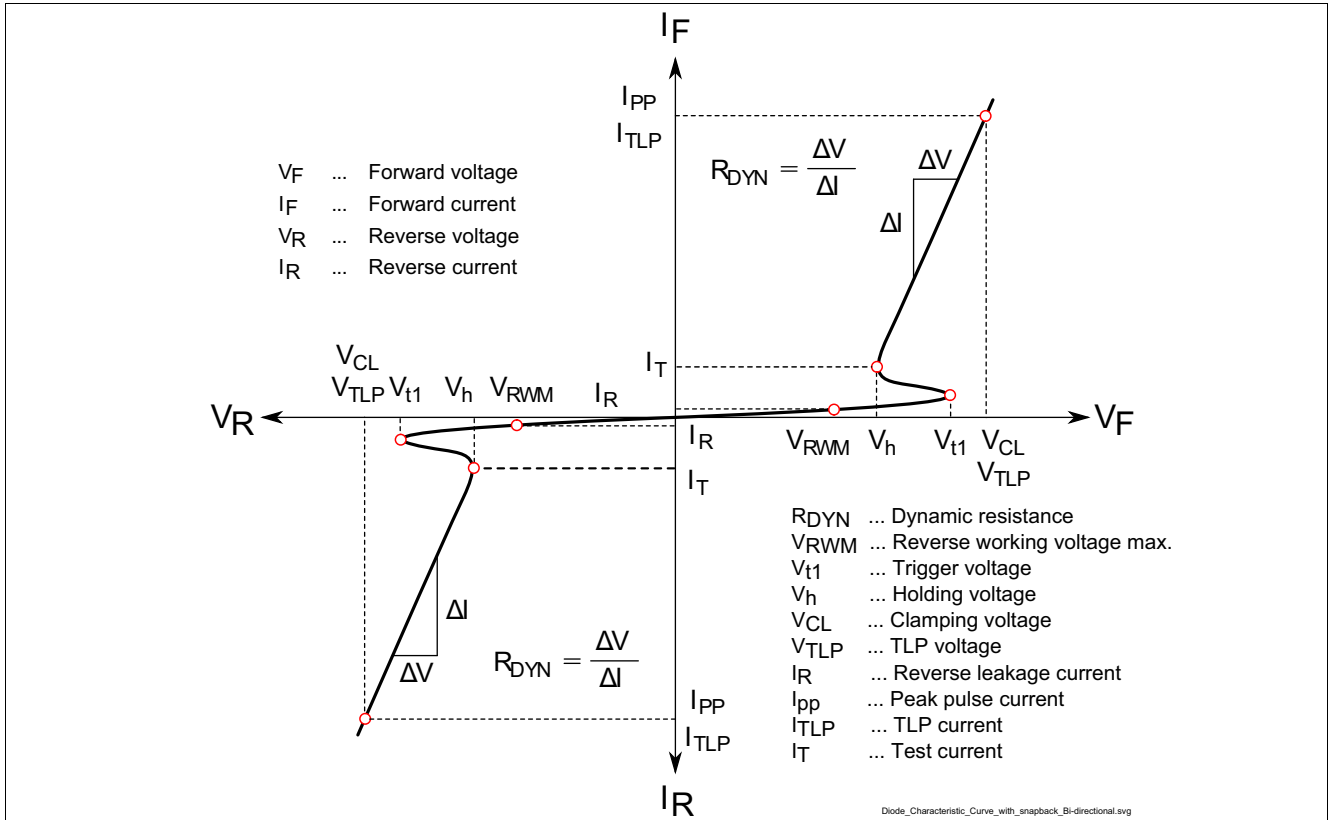

Figure 3-1 Definitions of electrical characteristics

Table 3-1 DC Characteristics at $T_A = 25\text{ }^\circ\text{C}$, unless otherwise specified¹⁾

Parameter	Symbol	Values			Unit	Note / Test Condition
		Min.	Typ.	Max.		
Trigger voltage	V_{t1}	6.1	9.5	–	V	
Holding voltage	V_h	6.1	7.8	12.5	V	$I_R = 10\text{ mA}$
Reverse current	I_R	–	–	20	nA	$V_R = 5.5\text{ V}$

1) Device is electrically symmetrical

Table 3-2 RF Characteristics at $T_A = 25\text{ }^\circ\text{C}$, unless otherwise specified

Parameter	Symbol	Values			Unit	Note / Test Condition
		Min.	Typ.	Max.		
Line capacitance	C_L	3	3.5	4.1	pF	$V_R = 0\text{ V}, f = 1\text{ MHz}$
		–	3.2	–		$V_R = 0\text{ V}, f = 1\text{ GHz}$

Electrical Characteristics at $T_A = 25\text{ }^\circ\text{C}$, unless otherwise specified
Table 3-3 ESD and Surge Characteristics at $T_A = 25\text{ }^\circ\text{C}$, unless otherwise specified ¹⁾

Parameter	Symbol	Values			Unit	Note / Test Condition
		Min.	Typ.	Max.		
Clamping voltage ²⁾	V_{CL}	–	12	–	V	$I_{TLP} = 16\text{ A}$, $t_p = 100\text{ ns}$
		–	16	–		$I_{TLP} = 30\text{ A}$, $t_p = 100\text{ ns}$
Clamping voltage ³⁾		–	8	–		$I_{PP} = 2\text{ A}$, $t_p = 8/20\text{ }\mu\text{s}$
		–	10	–		$I_{PP} = 9\text{ A}$, $t_p = 8/20\text{ }\mu\text{s}$
Dynamic resistance ²⁾	R_{DYN}	–	0.3	–	Ω	$t_p = 100\text{ ns}$

1) Device is electrically symmetrical

2) Please refer to Application Note AN210[1]. TLP parameter: $Z_0 = 50\text{ }\Omega$, $t_p = 100\text{ ns}$, $t_r = 0.6\text{ ns}$.

3) Stress pulse: 8/20 μs current waveform according to IEC61000-4-5

4 Typical Characteristics Diagrams

Typical characteristics diagrams at $T_A = 25^\circ\text{C}$, unless otherwise specified

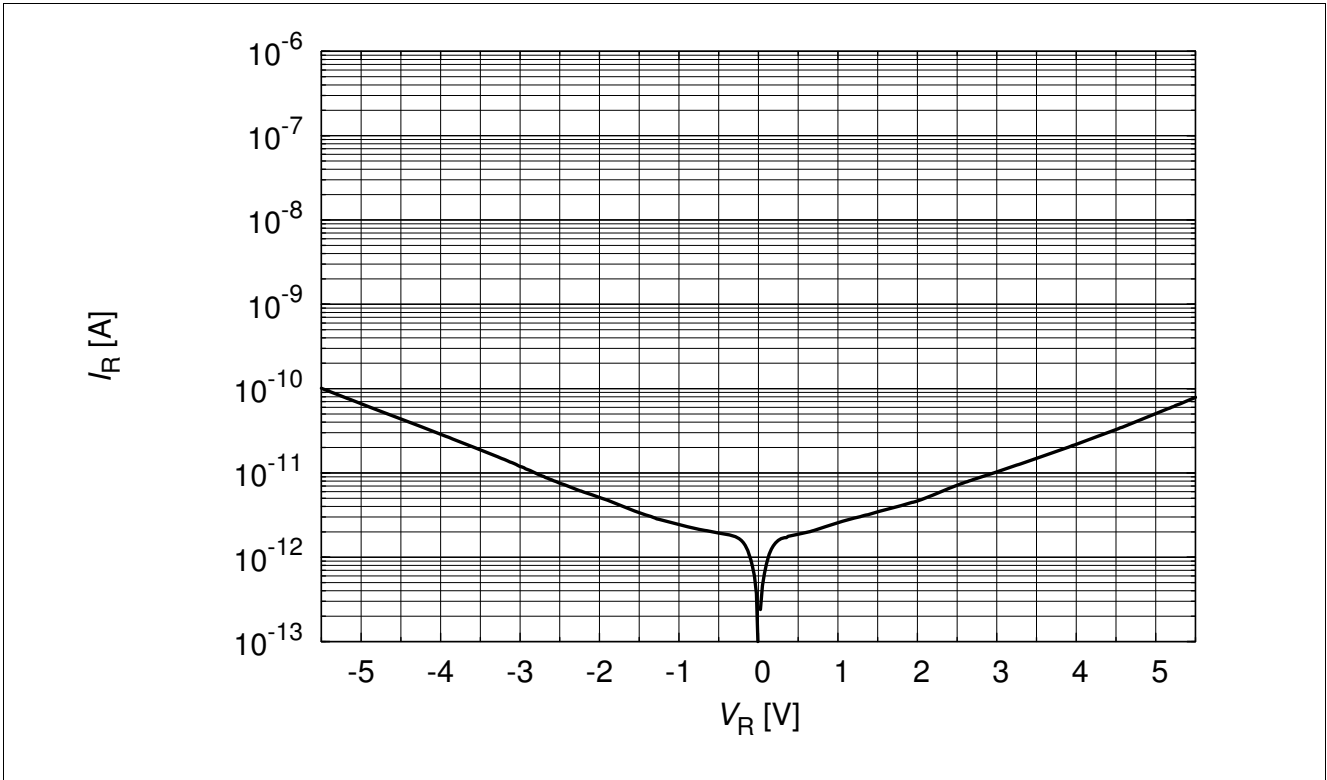

Figure 4-1 Reverse leakage current: $I_R = f(V_R)$

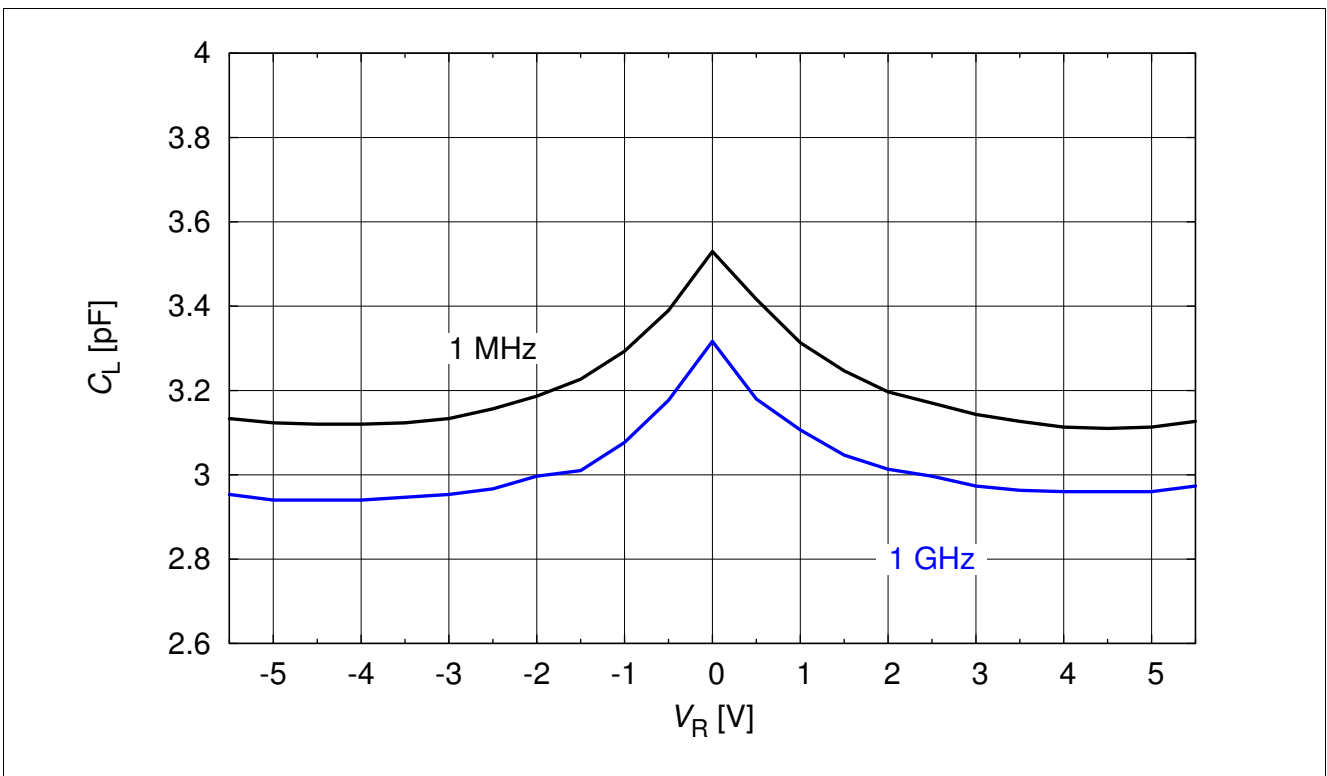

Figure 4-2 Line capacitance: $C_L = f(V_R)$

Typical Characteristics Diagrams

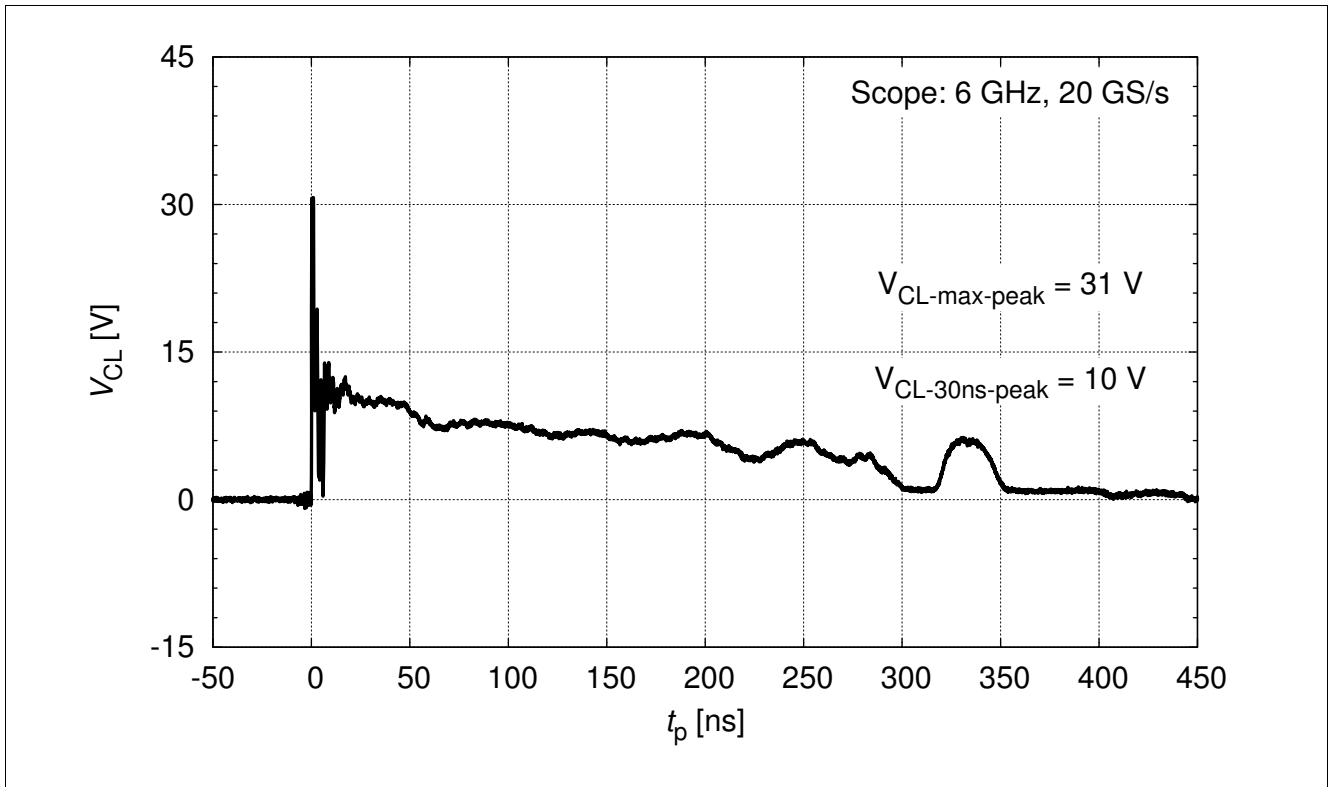

Figure 4-3 Clamping voltage (ESD): $V_{CL} = f(t)$, 8 kV positive pulse

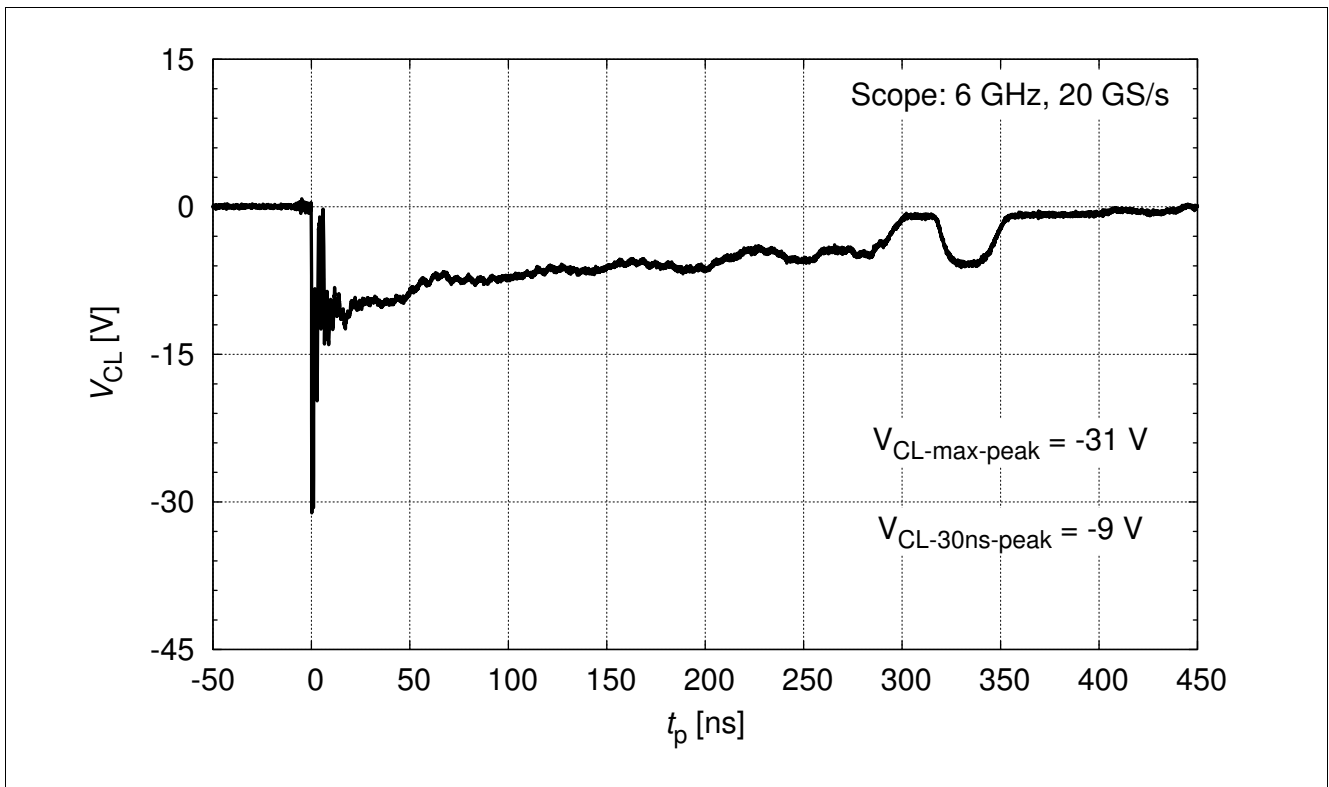

Figure 4-4 Clamping voltage (ESD): $V_{CL} = f(t)$, 8 kV negative pulse

Typical Characteristics Diagrams

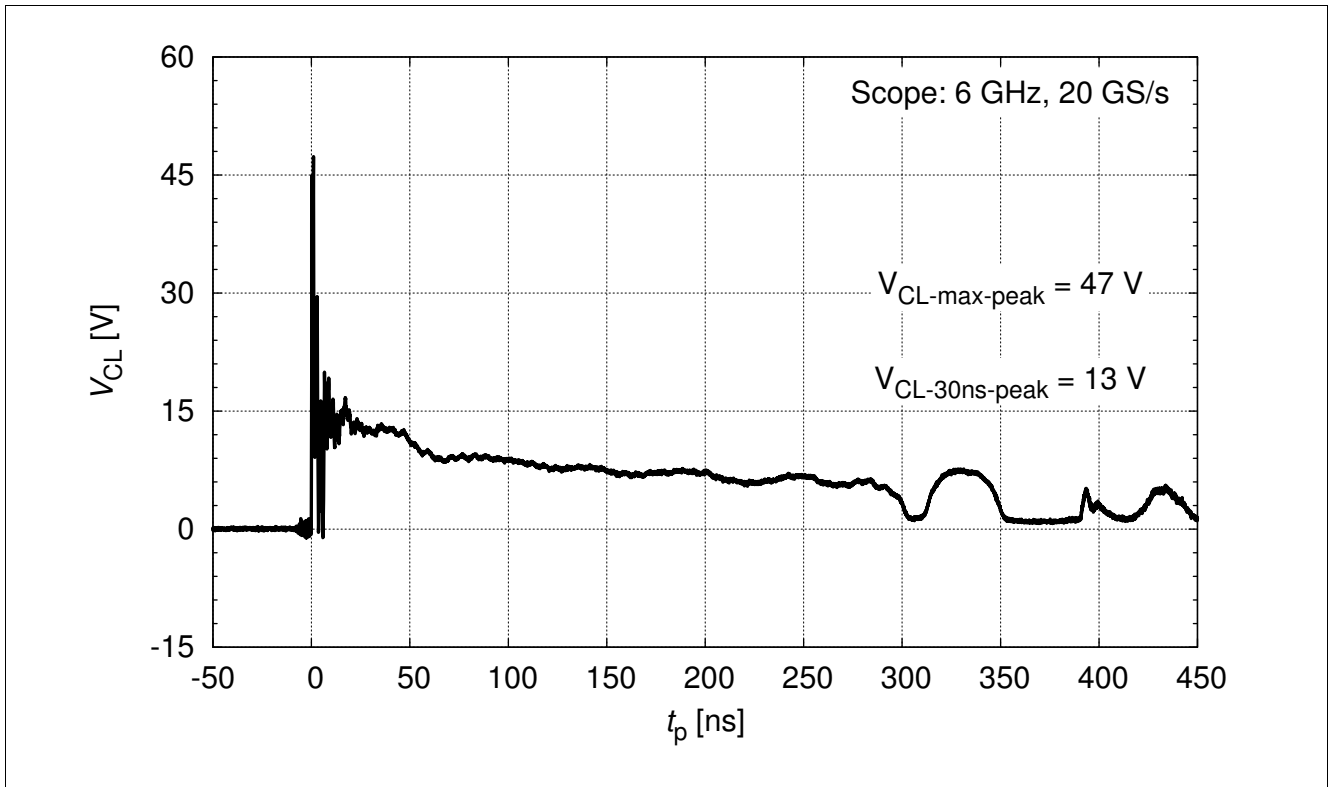

Figure 4-5 Clamping voltage (ESD): $V_{CL} = f(t)$, 15 kV positive pulse

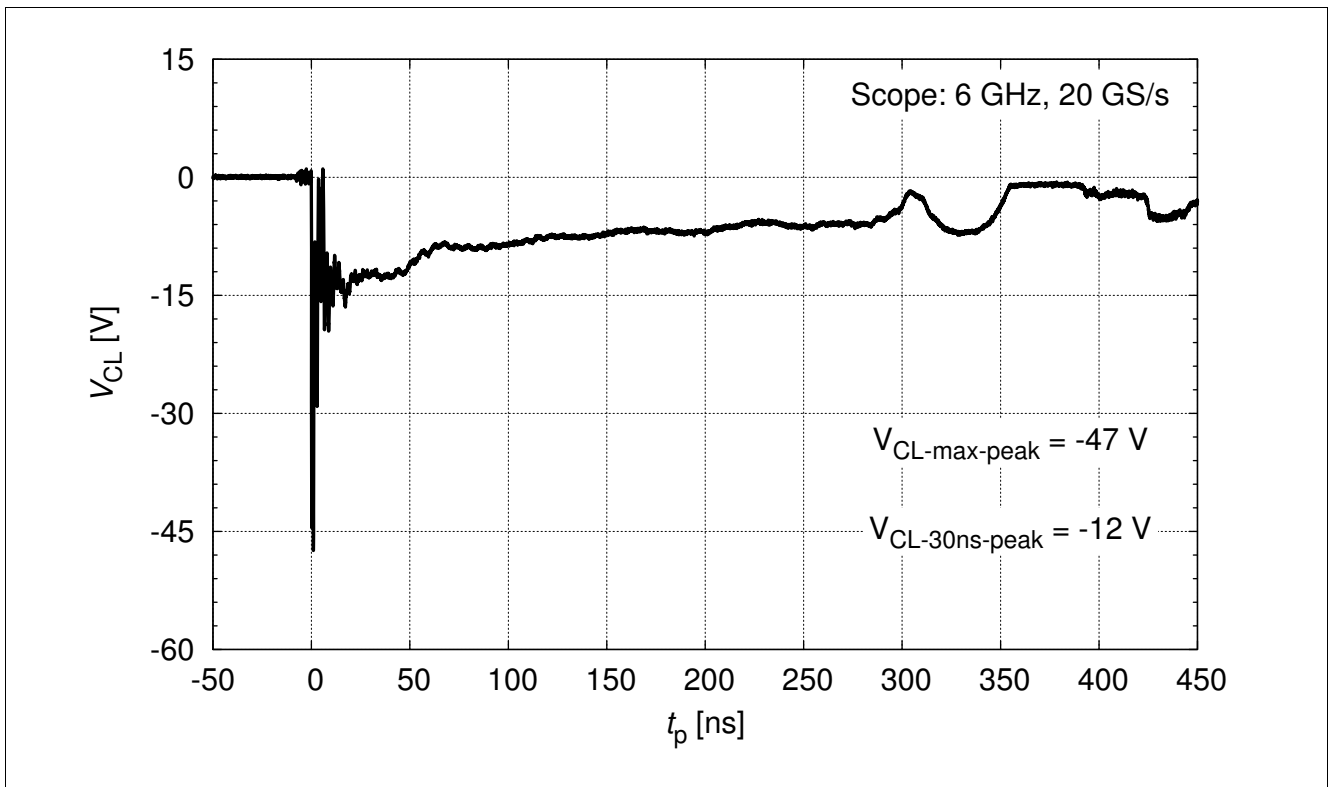

Figure 4-6 Clamping voltage (ESD): $V_{CL} = f(t)$, 15 kV negative pulse

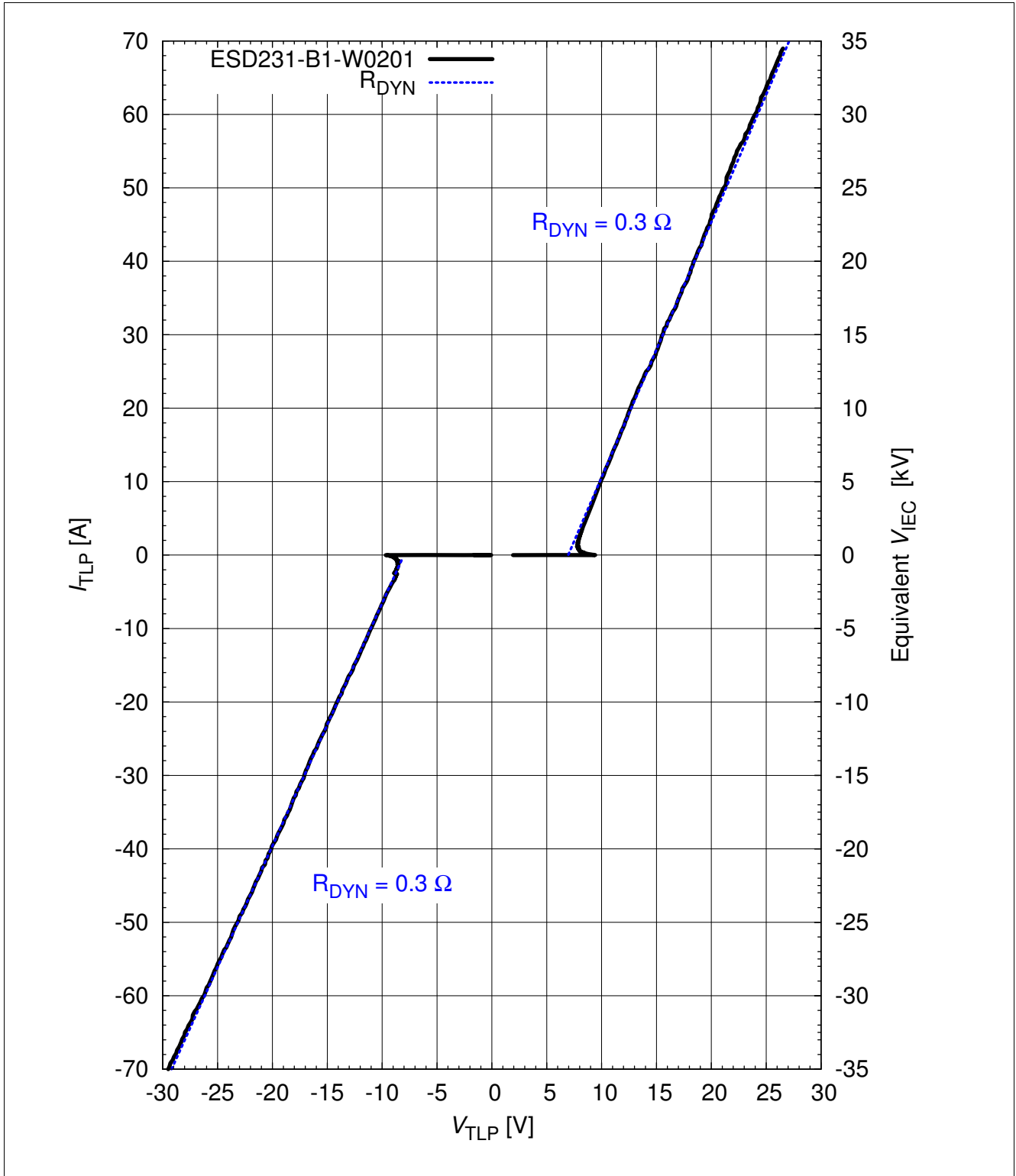

Figure 4-7 Clamping voltage (TLP): $I_{TLP} = f(V_{TLP})$ [1]

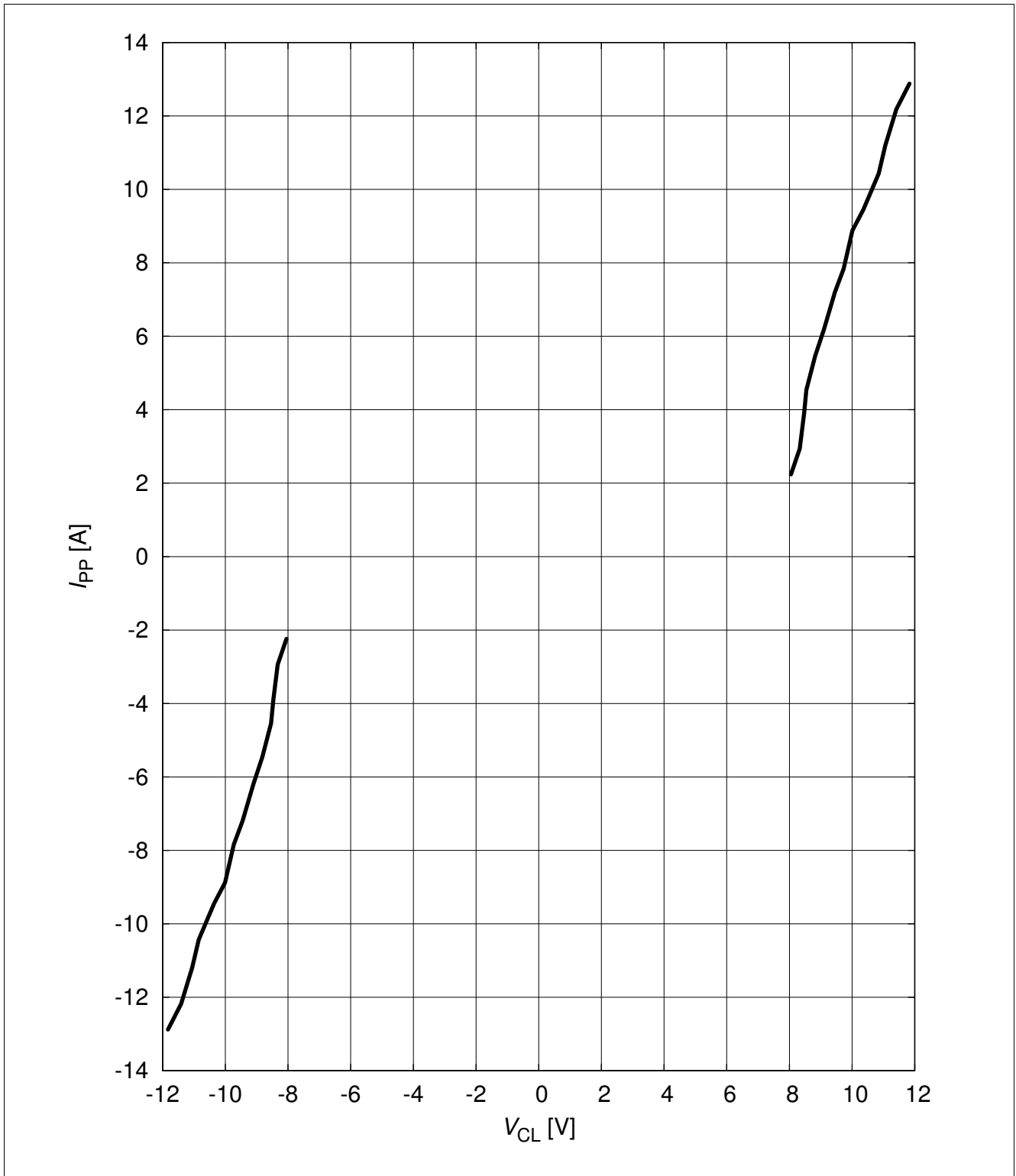

Figure 4-8 Clamping voltage (Surge): $I_{PP} = f(V_{CL})$ [1]

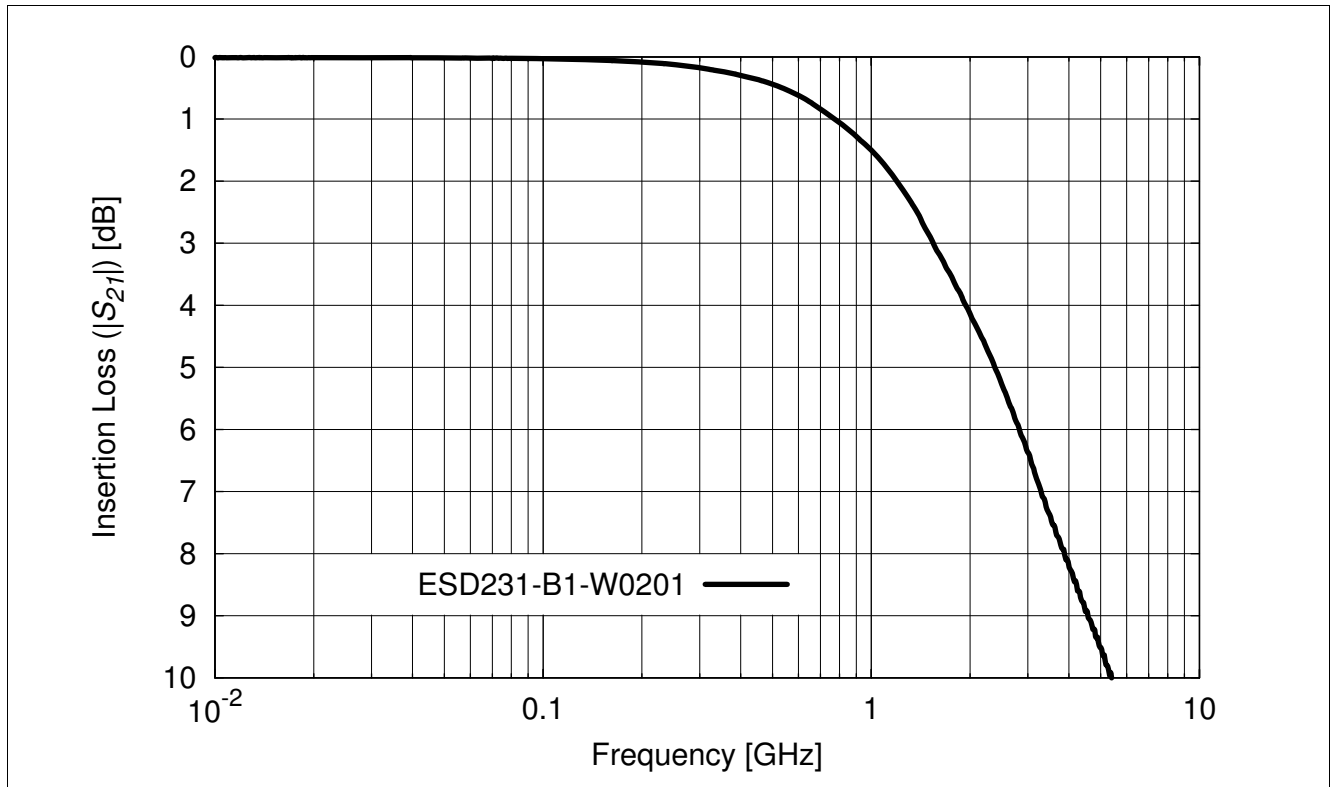

Figure 4-9 Insertion loss vs. frequency in a 50 Ω system

5 Package Information

5.1 WLL-2-1

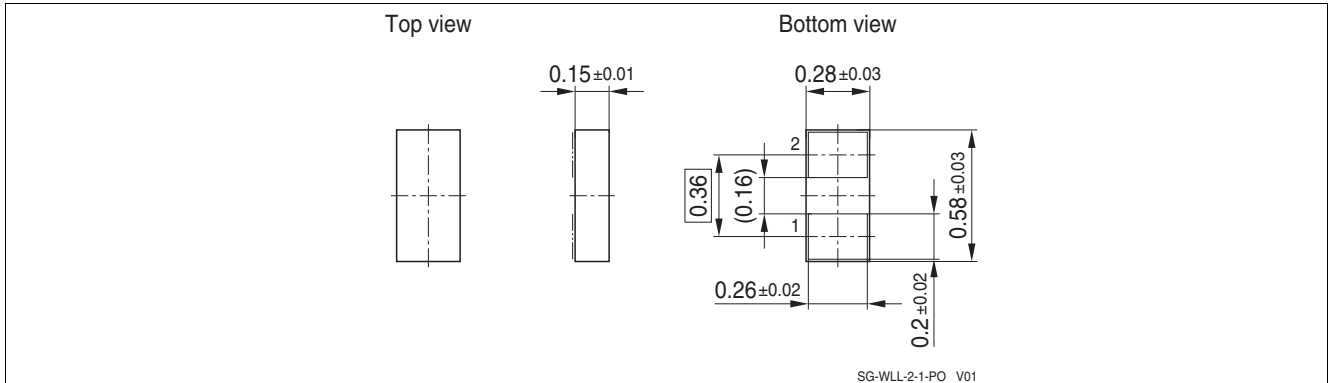

Figure 5-1 WLL-2-1 Package outline (dimension in mm)

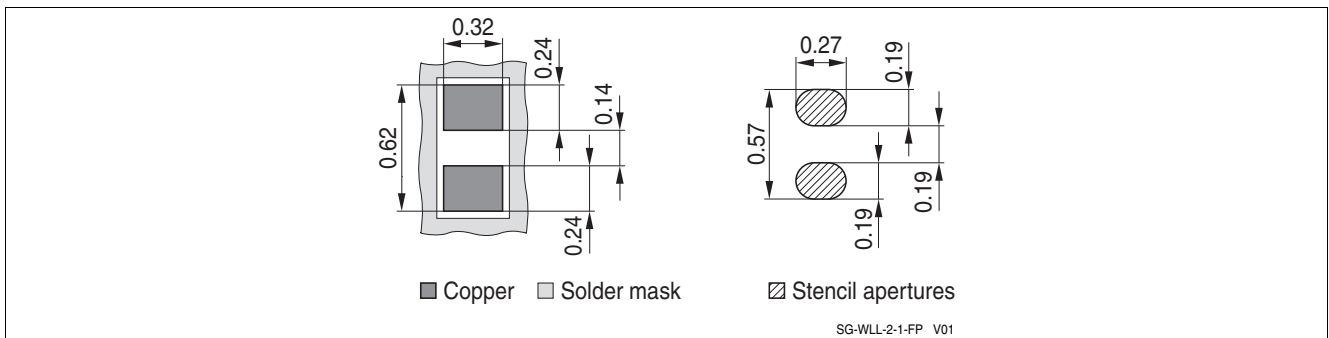

Figure 5-2 WLL-2-1 Footprint (dimension in mm) Recommendation for Printed Circuit Board Assembly^[2]

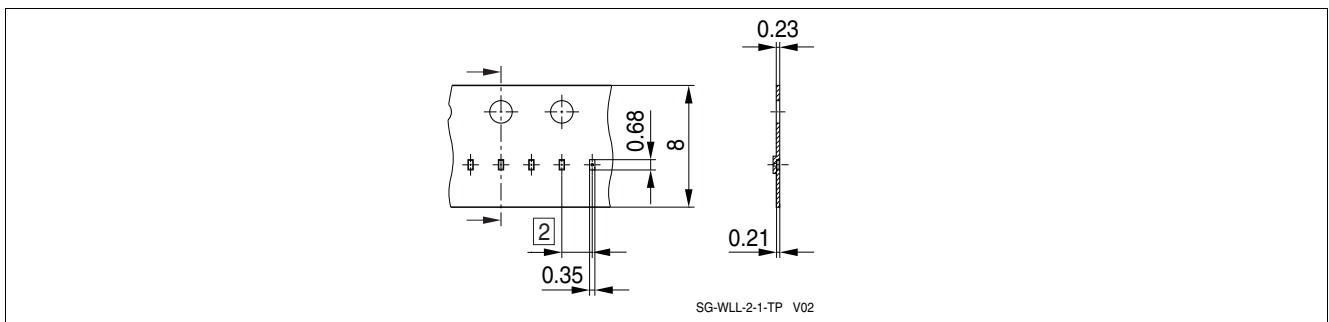

Figure 5-3 WLL-2-1 Packing (dimension in mm)

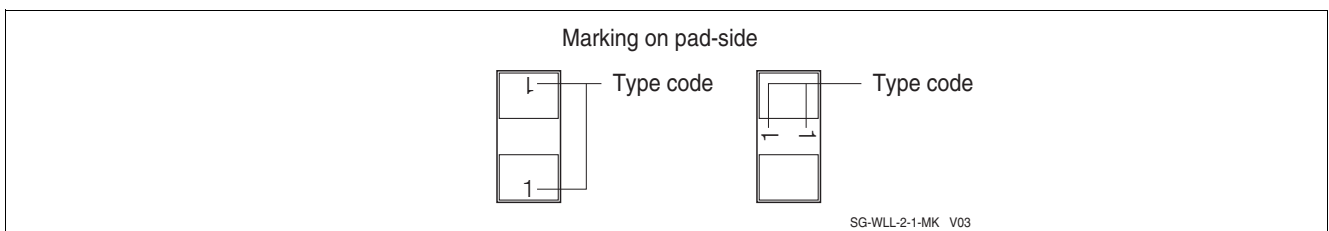

Figure 5-4 WLL-2-1 Marking example Table 1-1 "Part Information" on Page 3

References

- [1] Infineon AG - **Application Note AN210**: Effective ESD Protection design at System Level Using VF-TLP Characterization Methodology
- [2] Infineon AG - Recommendation for Printed Circuit Board Assembly of Infineon WLL Packages
<http://www.infineon.com/dgdl/?fileId=db3a304344f7b4f9014503db540027c0>
- [3] Infineon AG - **Application Note AN077**: Thermal Resistance Calculation

Revision History: Rev. 1.0 2015-07-31

Page or Item	Subjects (major changes since previous revision)
Revision 1.1, 2015-10-02	
All	Sales code change from ESD231-B1-CSP0201 to ESD231-B1-W0201

Trademarks of Infineon Technologies AG

AURIX™, BlueMoon™, C166™, CanPAK™, CIPOS™, CIPURSE™, COMNEON™, EconoPACK™, CoolMOS™, CoolSET™, CORECONTROL™, CROSSAVE™, DAVE™, EasyPIM™, EconoBRIDGE™, EconoDUAL™, EconoPIM™, EiceDRIVER™, eupec™, FCOS™, HITFET™, HybridPACK™, I²RF™, ISOFACE™, IsoPACK™, MIPAQ™, ModSTACK™, my-d™, NovalithIC™, OmniTune™, OptiMOS™, ORIGAT™, PRIMARION™, PrimePACK™, PrimeSTACK™, PRO-SIL™, PROFET™, RASIC™, ReverSave™, SatRIC™, SIEGET™, SINDRION™, SIPMOS™, SMARTi™, SmartLEWIS™, SOLID FLASH™, TEMPFET™, thinQ!™, TRENCHSTOP™, TriCore™, X-GOLD™, X-PMU™, XMM™, XPOSSYS™.

Other Trademarks

Advance Design System™ (ADS) of Agilent Technologies, AMBA™, ARM™, MULTI-ICE™, KEIL™, PRIMECELL™, REALVIEW™, THUMB™, μVision™ of ARM Limited, UK. AUTOSAR™ is licensed by AUTOSAR development partnership. Bluetooth™ of Bluetooth SIG Inc. CAT-ig™ of DECT Forum. COLOSSUS™, FirstGPS™ of Trimble Navigation Ltd. EMV™ of EMVCo, LLC (Visa Holdings Inc.). EPCOS™ of Epcos AG. FLEXGO™ of Microsoft Corporation. FlexRay™ is licensed by FlexRay Consortium. HYPERTERMINAL™ of Hilgraeve Incorporated. IEC™ of Commission Electrotechnique Internationale. IrDA™ of Infrared Data Association Corporation. ISO™ of INTERNATIONAL ORGANIZATION FOR STANDARDIZATION. MATLAB™ of MathWorks, Inc. MAXIM™ of Maxim Integrated Products, Inc. MICROTEC™, NUCLEUS™ of Mentor Graphics Corporation. Mifare™ of NXP. MIPI™ of MIPI Alliance, Inc. MIPS™ of MIPS Technologies, Inc., USA. muRata™ of MURATA MANUFACTURING CO., MICROWAVE OFFICE™ (MWO) of Applied Wave Research Inc., OmniVision™ of OmniVision Technologies, Inc. Openwave™ Openwave Systems Inc. RED HAT™ Red Hat, Inc. RFMD™ RF Micro Devices, Inc. SIRIUS™ of Sirius Satellite Radio Inc. SOLARIS™ of Sun Microsystems, Inc. SPANSION™ of Spansion LLC Ltd. Symbian™ of Symbian Software Limited. TAIYO YUDEN™ of Taiyo Yuden Co. TEAKLITE™ of CEVA, Inc. TEKTRONIX™ of Tektronix Inc. TOKO™ of TOKO KABUSHIKI KAISHA TA. UNIX™ of X/Open Company Limited. VERILOG™, PALLADIUM™ of Cadence Design Systems, Inc. VLYNQ™ of Texas Instruments Incorporated. VXWORKS™, WIND RIVER™ of WIND RIVER SYSTEMS, INC. ZETEX™ of Diodes Zetex Limited.

Last Trademarks Update 2010-10-26

www.infineon.com

Published by Infineon Technologies AG