

Medium Power Film Capacitors

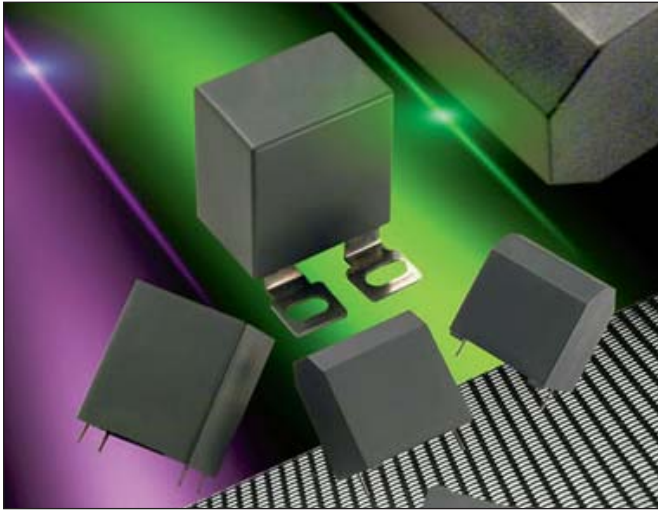

FSB (RoHS Compliant)



GENERAL DESCRIPTION

Metallized polypropylene dielectric capacitor with controlled self-healing.

Reinforced metallization developed for high impulse currents.

APPLICATIONS

- IGBT protection
- IGBT clamping

PACKAGING MATERIAL

- Plastic case backfilled with thermosetting resin

HOW TO ORDER

FSB ┆	1 ┆	6 ┆	U ┆	0154 ┆	J ┆	-- ┆	
Series	Case Size	Dielectric	Voltage Code	Capacitance Code	Capacitance Tolerances	Terminal Code	
	1 = PO Style 2 = 18 Style 3 = 19 Style 4 = 26 style 5 = R28 Style (2 terminal or 4 terminal) 6-C (Lug Terminals)	6 = Polypropylene	A = 700V B = 850V C = 1000V U = 1200V G = 1500V N = 2000V	0 + pF code 0154 = 0.15µF 0334 = 0.33µF 0255 = 2.5µF etc.	J = ± 5% K = ±10% (Case size 6 only)	-- = 2 Terminal JC = 4 Terminal (Case Size 5 option only) 90 = 90° Terminals 18 = 180° Terminals (Case size 6-C options only)	

PROTECTION

ELECTRICAL CHARACTERISTICS

Capacitance Range C_n	0.10µF to 5.6µF
Tolerance on C_n	±5%, ±10%
Rated DC Voltage V_{ndc}	700 to 2000 V
Stray Inductance	≤ 25 nH
RMS Current	I_{rms} max. = up to 28A The currents shown in the tables are maximum. It is necessary to maintain operation within the maximum temperature of the dielectric 85°C. See "Hot spot temperature calculation"
Insulation Resistance	$R_i \times C \geq 30,000$ s
Impulse Current	$I^2.t$ max. = up to 1.69 A ² s Spikes or peak currents in the capacitors may cause a deterioration of the bonding between the metallization and the connections. These bonds are capable of withstanding only a limited amount of energy for each spike. The table shows the maximum energy permitted in the form ($I^2.t$), where I is in Amperes, and t is in seconds.
Note:	The formula ($I^2.t$) replaces dv/dt which is less easy to use as it is not an expression of energy ($I = C.dv/dt$). This type of capacitor has been designed to withstand high ($I^2.t$) values.
Variation of Capacitance with Temperature	$\frac{\Delta C}{C} \leq \pm 2\%$ between -40 and +85°C
Climatic Category	40/085/56 (IEC 68)
Test Voltage Between Terminals @ 25°C	1.6 V_{ndc} during 10s
Withstanding Voltage Between Terminals and Case @ 25°C	@ 3 kVrms @ 50Hz during 1 min.

Medium Power Film Capacitors



FSB (RoHS Compliant)

GENERAL DESCRIPTION

STYLE: P0; 18; 19; 26; R68
ALL CASE SIZES
2 TERMINALS VERSION

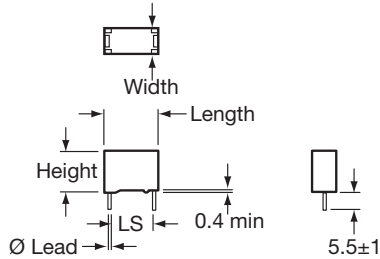

General Tolerance: 0.5mm

STYLE: R68
CASE SIZE 5 ONLY
4 TERMINALS VERSION

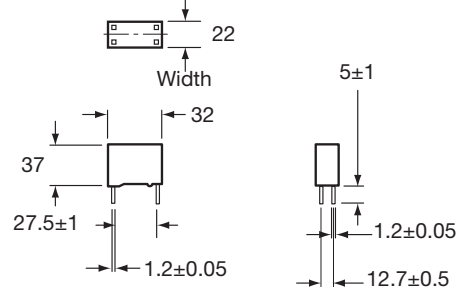

General Tolerance: 0.5mm

DIMENSIONS:

Case Size	Case Style	Length ±0.50 mm	Width ±0.50 mm	Height ±0.50 mm	Dimensions lead -0.05 mm	LS ±1.00 mm
1	P0	32	13.0	22.0	Ø 0.80	27.5
2	18	32	16.0	25.0	Ø 0.80	27.5
3	19	32	18.0	28.0	Ø 0.80	27.5
4	26	32	21.0	31.0	Ø 1.00	27.5
5	R68 2 Terminals Version	32	22.0	37.0	Ø 1.00	27.5
	R68 4 Terminals Version	32	22.0	37.0	Ø 1.20	27.5

PROTECTION

RATINGS AND PART NUMBER REFERENCE

Part Number	Capacitance (µF)	Case Style	Dv/Dt	I _{rms} (A)	R _s (mΩ)	R _{th} (hotspot/amb.)	ESL (nH)
V_{ndc}=1200V V_{peak}=1600V Vr_{ms}=560v Vs=2000V Voltage Code: U							
FSB16U0154J--	0.15	P0	500	3.0	14.3	45.9	25.0
FSB26U0274J--	0.27	18	500	7.6	8.4	36.8	25.0
FSB36U0394J--	0.39	19	500	11.0	6.2	32.2	25.0
FSB46U0474J--	0.47	26	500	12.0	5.6	29.4	25.0
FSB56U0684J--	0.68	R68 (2 terminals)	500	12.0	3.8	23.7	25.0
FSB56U0684JJC	0.68	R68 (4 terminals)	500	16.7	3.8	23.7	25.0
V_{ndc}=1600V V_{peak}=2000V Vr_{ms}=630v Vs=2300V Voltage Code: M							
FSB16M0134J--	0.13	P0	600	4.6	13.3	44.9	25.0
FSB26M0184J--	0.18	18	600	6.4	9.9	35.9	25.0
FSB36M0244J--	0.24	19	600	8.5	7.8	32.4	25.0
FSB46M0334J--	0.33	26	600	11.7	5.6	28.6	25.0
FSB56M0434J--	0.43	R68 (2 terminals)	600	12.0	4.6	23.8	25.0
FSB56M0434JJC	0.43	R68 (4 terminals)	600	15.2	4.6	23.8	25.0
V_{ndc}=2000V V_{peak}=2400V Vr_{ms}=700v Vs=2600V Voltage Code: N							
FSB16N0104J--	0.10	P0	700	4.2	14.3	44.6	25.0
FSB26N0134J--	0.13	18	700	5.5	11.3	35.7	25.0
FSB36N0184J--	0.18	19	700	7.6	8.5	32.1	25.0
FSB46N0224J--	0.22	26	700	9.3	6.8	29.1	25.0
FSB56N0304J--	0.30	R68 (2 terminals)	700	12.0	5.3	23.8	25.0
FSB56N0304JJC	0.30	R68 (4 terminals)	700	12.7	5.3	23.8	25.0

Medium Power Film Capacitors



FSB (RoHS Compliant)

CASE SIZE 6-C

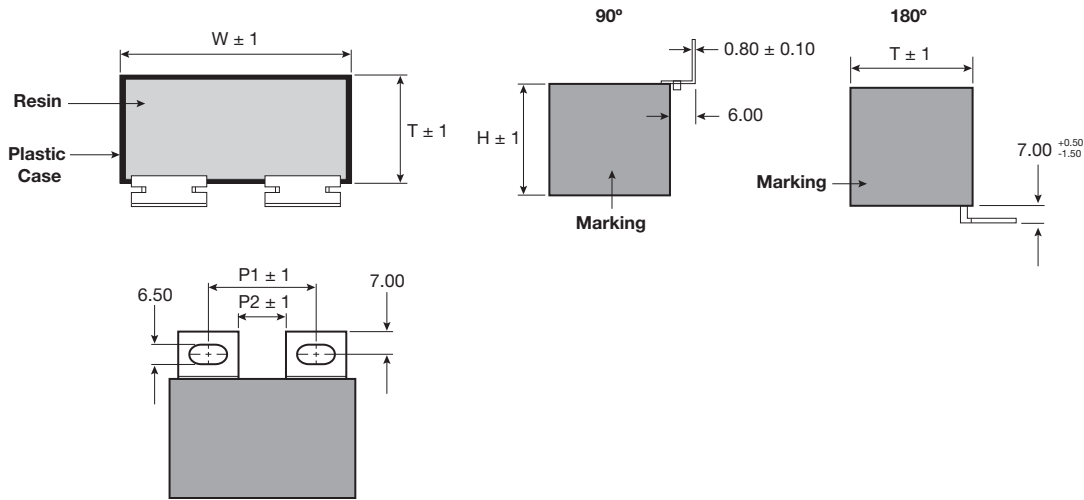

RATINGS AND PART NUMBER REFERENCE FOR LUG TERMINALS

PROTECTION

Cap (μ F) $\pm 10\%$	Rated Voltage (V)	AVX Part Number		Case Size	W ± 0.50 (mm)	H ± 0.50 (mm)	T ± 0.50 (mm)	P1 ± 0.50 (mm)	P2 ± 0.50 (mm)	dv/dt Volt/sec	I peak Amps	I rms Amps	Rs m Ω	ESL nH	Rth °C/W	Packaging Inner Box	
		90°	180°													Qty	Size
V_{ndc} = 700V V_{peak} = 1100V V_{rms} = 380V V_s = 1400V Voltage Code: A																	
1.20	700	FSBA6A0125K90	FSBA6A0125K18	A	42.50	27.5	24.5	23-28	11.0	600.0	720.0	17.5	4.0	18.0	16.4	42	360*170*80
2.00	700	FSBB6A0205K90	FSBB6A0205K18	B	42.50	35.5	33.5	23-28	11.0	600.0	1200.0	23.5	3.3	20.0	11.3	35	360*170*80
2.20	700	FSBB6A0225K90	FSBB6A0225K18	B	42.50	35.5	33.5	23-28	11.0	600.0	1320.0	24.0	3.1	20.0	10.8	35	360*170*80
2.50	700	FSBB6A0255K90	FSBB6A0255K18	B	42.50	35.5	33.5	23-28	11.0	600.0	1500.0	24.5	2.9	20.0	10.1	35	360*170*80
3.00	700	FSBB6A0305K90	FSBB6A0305K18	B	42.50	45.0	33.0	23-28	11.0	600.0	1800.0	27.5	2.7	20.0	7.7	40	360*170*80
3.30	700	FSB96A0335K90	FSB96A0335K18	9	42.50	45.0	33.0	23-28	11.0	600.0	1980.0	28.0	2.7	25.0	7.2	40	360*170*80
3.50	700	FSB96A0355K90	FSB96A0355K18	9	42.50	45.0	33.0	23-28	11.0	600.0	2100.0	28.5	2.6	25.0	7.4	40	360*170*80
4.00	700	FSB86A0405K90	FSB86A0405K18	8	57.50	45.0	30.0	37-39	24.0	360.0	1440.0	29.0	4.4	35.0	7.9	25	360*170*80
4.70	700	FSB76A0475K90	FSB76A0475K18	7	57.50	50.0	35.0	37-39	24.0	360.0	1692.0	35.0	4.1	38.0	6.9	20	360*170*80
5.00	700	FSB76A0505K90	FSB76A0505K18	7	57.50	50.0	35.0	37-39	24.0	360.0	1800.0	37.0	3.9	38.0	6.9	20	360*170*80
5.60	700	FSB76A0565K90	FSB76A0565K18	7	57.50	50.0	35.0	37-39	24.0	360.0	2016.0	39.0	3.7	38.0	6.5	20	360*170*80
V_{ndc} = 850V V_{peak} = 1200V V_{rms} = 450V V_s = 1500V Voltage Code: B																	
0.82	850	FSBA6B0824K90	FSBA6B0824K18	A	42.5	27.5	24.5	23-28	11.0	750.0	615.0	13.0	6.7	18.0	20.7	42	360*170*80
1.00	850	FSBA6B0105K90	FSBA6B0105K18	A	42.5	27.5	24.5	23-28	11.0	750.0	750.0	15.0	5.5	18.0	18.8	42	360*170*80
1.50	850	FSBB6B0155K90	FSBB6B0155K18	B	42.5	35.5	33.5	23-28	11.0	750.0	1125.0	22.0	3.9	20.0	13.9	35	360*170*80
1.75	850	FSBB6B0175K90	FSBB6B0175K18	B	42.5	35.5	33.5	23-28	11.0	750.0	1312.5	24.0	3.4	20.0	12.6	35	360*170*80
2.00	850	FSB66B0205K90	FSB66B0205K18	6	42.5	45.0	30.0	23-28	11.0	750.0	1500.0	25.0	3.4	25.0	19.1	40	360*170*80
2.20	850	FSB66B0225K90	FSB66B0225K18	6	42.5	45.0	30.0	23-28	11.0	750.0	1650.0	28.0	3.1	25.0	18.6	40	360*170*80
2.50	850	FSB66B0255K90	FSB66B0255K18	6	42.5	45.0	30.0	23-28	11.0	750.0	1875.0	28.0	2.7	25.0	17.8	40	360*170*80
2.50	850	FSB76B0255K90	FSB76B0255K18	7	57.5	50.0	35.0	37-39	24.0	469.0	1172.5	24.0	5.3	38.0	10.7	20	360*170*80
3.00	850	FSB86B0305K90	FSB86B0305K18	8	57.5	45.0	30.0	37-39	24.0	469.0	1407.0	27.0	4.5	35.0	9.9	25	360*170*80
3.30	850	FSB86B0335K90	FSB86B0335K18	8	57.5	45.0	30.0	37-39	24.0	469.0	1547.7	27.5	4.1	35.0	9.3	25	360*170*80
4.00	850	FSB76B0405K90	FSB76B0405K18	7	57.5	50.0	35.0	37-39	24.0	469.0	1876.0	33.0	3.5	38.0	8.0	20	360*170*80
5.00	850	FSB66B0505K90	FSB66B0505K18	6	57.5	50.0	35.0	37-39	24.0	469.0	2345.0	37.0	2.9	38.0	6.9	20	360*170*80
V_{ndc} = 1000V V_{peak} = 1300 V_{rms} = 480V V_s=1700V Voltage Code: C																	
0.68	1000	FSBA6C0684K90	FSBA6C0684K18	A	42.5	27.5	24.5	23-28	11.0	870.0	591.6	16.5	4.3	18.0	14.6	42	360*170*80
0.75	1000	FSBA6C0754K90	FSBA6C0754K18	A	42.5	27.5	24.5	23-28	11.0	870.0	652.5	17.5	4.0	18.0	14.2	42	360*170*80
1.20	1000	FSBB6C0125K90	FSBB6C0125K18	B	42.5	35.5	33.5	23-28	11.0	870.0	1044.0	23.5	3.3	20.0	9.2	35	360*170*80
1.50	1000	FSBB6C0155K90	FSBB6C0155K18	B	42.5	35.5	33.5	23-28	11.0	870.0	1305.0	25.0	2.9	20.0	8.9	35	360*170*80
1.75	1000	FSB96C0175K90	FSB96C0175K18	9	42.5	45.0	33.0	23-28	11.0	870.0	1522.5	27.0	2.7	25.0	7.0	40	360*170*80
2.00	1000	FSB96C0205K90	FSB96C0205K18	9	42.5	45.0	33.0	23-28	11.0	870.0	1740.0	28.0	2.6	25.0	6.9	40	360*170*80
2.20	1000	FSB86C0225K90	FSB86C0225K18	8	57.5	45.0	30.0	37-39	24.0	500.0	1100.0	27.5	3.3	35.0	8.1	25	360*170*80
2.50	1000	FSB96C0255K90	FSB96C0255K18	9	42.5	45.0	33.0	23-28	11.0	750.0	1875.0	24.5	4.0	25.0	6.0	40	360*170*80
3.00	1000	FSB86C0305K90	FSB86C0305K18	8	57.5	45.0	30.0	37-39	24.0	450.0	1350.0	24.5	4.8	35.0	6.4	25	360*170*80
3.00	1000	FSB76C0305K90	FSB76C0305K18	7	57.5	50.0	35.0	37-39	24.0	500.0	1500.0	32.0	2.7	38.0	5.7	20	360*170*80
3.30	1000	FSB86C0335K90	FSB86C0335K18	8	57.5	45.0	30.0	37-39	24.0	450.0	1485.0	25.5	4.6	35.0	6.9	25	360*170*80
3.30	1000	FSB76C0335K90	FSB76C0335K18	7	57.5	50.0	35.0	37-39	24.0	450.0	1485.0	32.5	2.6	38.0	5.5	20	360*170*80
4.00	1000	FSB76C0405K90	FSB76C0405K18	7	57.5	50.0	35.0	37-39	24.0	450.0	1800.0	29.5	4.0	38.0	5.6	20	360*170*80

Medium Power Film Capacitors



FSB (RoHS Compliant)

Cap (μ F) $\pm 10\%$	Rated Voltage (V)	AVX Part Number		Case Size	W ± 0.50 (mm)	H ± 0.50 (mm)	T ± 0.50 (mm)	P1 ± 0.50 (mm)	P2 ± 0.50 (mm)	dv/dt Volt/sec	I peak Amps	I rms Amps	Rs m Ω	ESL nH	Rth °C/W	Packaging Inner Box	
		90°	180°													Qty	Size
V_{ndc} = 1200V V_{peak} = 1600V V_{rms} = 560V V_s = 2000V Voltage Code: U																	
0.33	1200	FSBA6U0334K90	FSBA6U0334K18	A	42.5	27.5	24.5	23~28	11.0	1000.0	330.0	9.3	7.4	18.0	20.3	42	360*170*80
0.39	1200	FSBA6U0394K90	FSBA6U0394K18	A	42.5	27.5	24.5	23~28	11.0	1000.0	390.0	10.5	6.4	18.0	18.7	42	360*170*80
0.47	1200	FSBA6U0474K90	FSBA6U0474K18	A	42.5	27.5	24.5	23~28	11.0	1000.0	470.0	11.9	5.5	18.0	16.3	42	360*170*80
0.56	1200	FSBA6U0564K90	FSBA6U0564K18	A	42.5	27.5	24.5	23~28	11.0	1000.0	560.0	13.7	4.8	18.0	14.9	42	360*170*80
0.68	1200	FSBB6U0684K90	FSBB6U0684K18	B	42.5	35.5	33.5	23~28	11.0	1000.0	680.0	16.5	4.1	20.0	12.0	35	360*170*80
0.82	1200	FSBB6U0824K90	FSBB6U0824K18	B	42.5	35.5	33.5	23~28	11.0	1000.0	820.0	18.5	3.6	20.0	11.0	35	360*170*80
1.00	1200	FSB66U0105K90	FSB66U0105K18	B	42.5	45.0	30.0	23~28	11.0	1000.0	1000.0	17.3	3.7	25.0	12.3	40	360*170*80
1.20	1200	FSBB6U0125K90	FSBB6U0125K18	B	42.5	35.5	33.5	23~28	11.0	1000.0	1200.0	18.4	3.3	20.0	12.4	35	360*170*80
1.20	1200	FSB66U0125K90	FSB66U0125K18	6	42.5	45.0	30.0	23~28	11.0	1200.0	1440.0	26.0	3.4	25.0	17.5	40	360*170*80
1.50	1200	FSB66U0155K90	FSB66U0155K18	6	42.5	45.0	30.0	23~28	11.0	870.0	1305.0	26.0	3.4	25.0	17.5	40	360*170*80
1.50	1200	FSBB6U0155K90	FSBB6U0155K18	B	42.5	35.5	33.5	23~28	11.0	1000.0	1500.0	21.0	2.8	20.0	11.2	35	360*170*80
2.00	1200	FSB96U0205K90	FSB96U0205K18	9	42.5	45.0	30.0	23~28	11.0	870.0	1740.0	28.0	2.8	25.0	7.2	25	360*170*80
2.00	1200	FSB86U0205K90	FSB86U0205K18	8	57.5	45.0	30.0	37~39	24.0	575.0	1150.0	19.7	2.4	35.0	8.8	25	360*170*80
2.20	1200	FSB86U0225K90	FSB86U0225K18	8	57.5	45.0	30.0	37~39	24.0	500.0	1100.0	21.0	4.2	35.0	8.1	25	360*170*80
2.20	1200	FSB76U0225K90	FSB76U0225K18	7	57.5	50.0	35.0	37~39	24.0	575.0	1265.0	21.4	3.9	38.0	7.6	20	360*170*80
2.50	1200	FSB86U0255K90	FSB86U0255K18	8	57.5	45.0	30.0	37~39	24.0	500.0	1250.0	21.2	4.9	35.0	7.9	25	360*170*80
3.00	1200	FSB76U0305K90	FSB76U0305K18	7	57.5	50.0	35.0	37~39	24.0	575.0	1725.0	32.8	4.3	38.0	6.5	20	360*170*80
3.30	1200	FSB76U0335K90	FSB76U0335K18	7	57.5	50.0	35.0	37~39	24.0	500.0	1650.0	28.2	3.0	38.0	6.2	20	360*170*80
V_{ndc} = 1500V V_{peak} = 1950V V_{rms} = 600V V_s = 2250V Voltage Code: G																	
0.33	1500	FSBA6G0334K90	FSBA6G0334K18	A	42.5	27.5	24.5	23~28	11.00	1220.0	402.6	14.0	6.0	18.0	17.0	42	360*170*80
0.39	1500	FSBA6G0394K90	FSBA6G0394K18	A	42.5	27.5	24.5	23~28	11.00	1220.0	475.8	14.5	5.6	18.0	15.9	42	360*170*80
0.47	1500	FSBB6G0474K90	FSBB6G0474K18	B	42.5	35.5	33.5	23~28	11.00	1220.0	573.4	19.0	4.8	20.0	11.0	35	360*170*80
0.68	1500	FSBB6G0684K90	FSBB6G0684K18	B	42.5	35.5	33.5	23~28	11.00	1220.0	829.6	21.0	4.0	20.0	9.8	35	360*170*80
0.75	1500	FSBB6G0754K90	FSBB6G0754K18	B	42.5	35.5	33.5	23~28	11.00	1220.0	915.0	22.0	3.6	20.0	9.4	35	360*170*80
1.00	1500	FSB96G0105K90	FSB96G0105K18	9	42.5	45.0	33.0	23~28	11.00	1220.0	1220.0	23.0	3.3	25.0	7.4	40	360*170*80
1.20	1500	FSB86G0125K90	FSB86G0125K18	8	57.5	45.0	30.0	37~39	24.00	870.0	1044.0	26.0	3.6	35.0	7.3	25	360*170*80
1.50	1500	FSB76G0155K90	FSB76G0155K18	7	57.5	50.0	35.0	37~39	24.00	725.0	1087.5	29.5	3.3	38.0	5.9	20	360*170*80
1.80	1500	FSB76G0185K90	FSB76G0185K18	7	57.5	50.0	35.0	37~39	24.00	725.0	1305.0	30.5	3.0	38.0	5.6	20	360*170*80
V_{ndc} = 2000V V_{peak} = 2400V V_{rms} = 700V V_s = 2600V Voltage Code: N																	
0.10	2000	FSBA6N0104K90	FSBA6N0104K18	A	42.5	27.5	24.5	23~28	11.0	1600.0	160.0	8.5	16.3	18.0	23.6	42	360*170*80
0.15	2000	FSBA6N0154K90	FSBA6N0154K18	A	42.5	27.5	24.5	23~28	11.0	1600.0	240.0	11.0	9.8	18.0	18.8	42	360*170*80
0.22	2000	FSBA6N0224K90	FSBA6N0224K18	A	42.5	27.5	24.5	23~28	11.0	1600.0	352.0	13.5	6.6	18.0	15.3	42	360*170*80
0.33	2000	FSBA6N0334K90	FSBA6N0334K18	A	42.5	27.5	24.5	23~28	11.0	1220.0	402.6	12.5	9.6	18.0	15.1	42	360*170*80
0.33	2000	FSBB6N0334K90	FSBB6N0334K18	B	42.5	35.5	33.5	23~28	11.0	1600.0	528.0	18.0	5.3	20.0	9.8	35	360*170*80
0.39	2000	FSBB6N0394K90	FSBB6N0394K18	B	42.5	35.5	33.5	23~28	11.0	1000.0	390.0	17.5	4.7	20.0	9.4	35	360*170*80
0.47	2000	FSB66N0474K90	FSB66N0474K18	6	42.5	45.0	30.0	23~28	11.0	1600.0	752.0	22.0	6.3	25.0	19.4	40	360*170*80
0.56	2000	FSB66N0564K90	FSB66N0564K18	6	42.5	45.0	30.0	23~28	11.0	1600.0	896.0	23.0	5.2	25.0	17.9	40	360*170*80
0.68	2000	FSB66N0684K90	FSB66N0684K18	6	42.5	45.0	30.0	23~28	11.0	1200.0	816.0	24.0	4.4	25.0	17.3	40	360*170*80
0.68	2000	FSBB6N0684K90	FSBB6N0684K18	B	42.5	35.5	33.5	23~28	11.0	1220.0	829.6	18.0	6.5	20.0	7.1	35	360*170*80
0.82	2000	FSB96N0824K90	FSB96N0824K18	9	42.5	45.0	33.0	23~28	11.0	1220.0	1000.4	20.0	6.0	25.0	7.0	40	360*170*80
0.82	2000	FSB86N0824K90	FSB86N0824K18	8	57.5	45.0	30.0	37~39	24.0	930.0	762.6	24.5	4.0	35.0	7.4	25	360*170*80
1.00	2000	FSB96N0105K90	FSB96N0105K18	9	42.5	45.0	33.0	23~28	11.0	1220.0	1220.0	21.5	5.3	25.0	6.9	40	360*170*80
1.00	2000	FSB76N0105K90	FSB76N0105K18	7	57.5	50.0	35.0	37~39	24.0	930.0	930.0	28.0	3.6	38.0	6.0	20	360*170*80
1.20	2000	FSB86N0125K90	FSB86N0125K18	8	57.5	45.0	30.0	37~39	24.0	725.0	870.0	22.5	5.9	35.0	6.6	25	360*170*80
1.50	2000	FSB76N0155K90	FSB76N0155K18	7	57.5	50.0	35.0	37~39	24.0	725.0	1087.5	26.0	5.2	38.0	4.9	20	360*170*80

* Insert K for 10% capacitance tolerance (standard); J = +5% tolerances available on request.

Last two characters terminal styles 90 = 90° terminals insert 18 = 180°

Values outside this standard range may be available – please contact AVX for any special requirements.

AVX reserves the right to supply capacitors to a tighter capacitance tolerance or higher voltage rating, in the same case size.

PROTECTION

STANDARDS

IEC 61071-1, IEC 61071-2: Power electronic capacitors

TANGENT OF LOSS ANGLE (TANδ₀) FOR POLYPROPYLENE DIELECTRIC

Polypropylene has a constant dielectric loss factor of 2x10⁻⁴ irrespective of temperature and frequency (up to 1 MHz).

IGBT SNUBBER

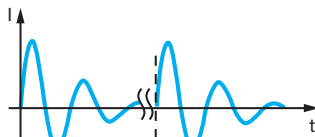
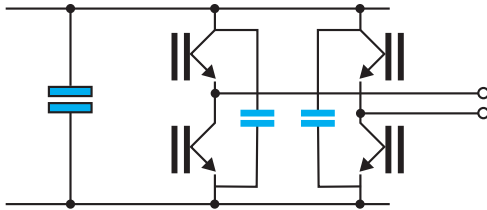

With

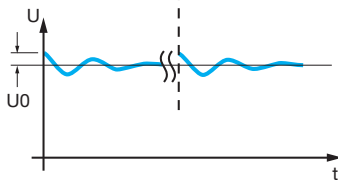

L = stray inductance IGBT + capacitor

R = serial resistance IGBT + capacitor

HOT SPOT TEMPERATURE CALCULATION

See *Hot Spot Temperature*, page 3.

$$\theta_{\text{hot spot}} = \theta_{\text{ambient}} + (P_d + P_t) \times R_{th}$$

with P_d (Dielectric losses) = $Q \times \text{tg}\delta_0$
 $\Rightarrow [\frac{1}{2} \times C_n \times (V_{\text{ripple peak to peak}})^2 \times f] \times (2 \times 10^{-4})$
 P_t (Thermal losses) = $R_s \times (I_{rms})^2$
 R_{th} : $R_{th \text{ ambient / hot spot}}$ in °C/W

where C_n in Farad I_{rms} in Ampere f in Hertz
 V in Volt R_s in Ohm θ in °C

Due to the design of the capacitor and its technology, the thermal impedance between the terminations and the core of the capacitor is low, it is necessary to take care that the capacitor is never overheated by use of wrongly sized connections.

Do not use the capacitor as a heat sink.

Due to the complexity of the IGBT / capacitor thermal exchanges, we recommend that thermal measurements shall be made on the different components. We would be pleased to advise you on specific applications.

WORKING TEMPERATURE

(according to the power to be dissipated) -40°C to +85°C

MARKING

AVX logo

Capacitance and tolerance in clear

Nominal DC voltage in clear

RMS current in clear

Date of manufacture (IEC coding)

$$I_{eff} = \sqrt{\left[\frac{C\beta_0^2 \times U_0}{2j\beta} \right]^2 \times \frac{1}{T} \times \left[\frac{e^{-2\alpha \times T}}{\beta^2 + \alpha^2} \times [\beta \sin(2\beta \times T) - \alpha \times \cos(2\beta \times T)] + \frac{1}{\alpha} \times e^{-2\alpha \times T} + \frac{\alpha}{\beta^2 + \alpha^2} - \frac{1}{\alpha} \right]}$$

with $\beta_0 = \sqrt{\frac{1}{LC}}$; $\alpha = \frac{R}{2L}$; $\beta = \sqrt{\beta_0^2 - \alpha^2}$