

**KEMET Part Number: LDECA2100JA0N00**  
(DECA2100JA0N00)

LDE, Film, Metallized PEN Stacked, Automotive Grade, 0.01 uF, 5%, 50 V, 40 VAC, 125C, 1206, 1.1mm

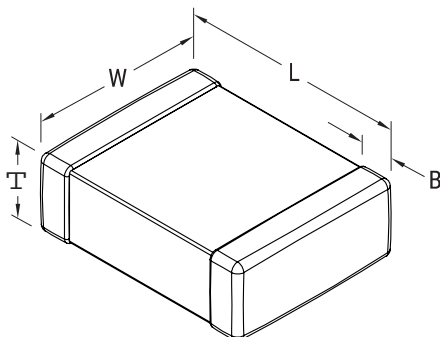

Dimensions	
Chip Size	1206
L	3.3mm +0.3/-0.1mm
W	1.7mm +/-0.2mm
T	1.1mm MAX
B	0.5mm +0.5/-0.3mm

Packaging Specifications	
Packaging:	T&R
Packaging Quantity:	3000

General Information	
Supplier:	KEMET
Series:	LDE
Dielectric:	Metallized PEN Stacked
Style:	SMD Chip
Features:	Automotive Grade
RoHS:	Yes
Qualifications:	AEC-Q200
AEC-Q200:	Yes

Specifications	
Capacitance:	0.01 uF
Capacitance Tolerance:	5%
Voltage DC:	50 VDC
Voltage AC:	40 VAC
Temperature Range:	-55/+125C
Rated Temperature:	125C
Dissipation Factor:	0.8% 1kHz
Insulation Resistance:	1 GOhms
Max dV/dt:	100 V/us