

# SPECIFICATION

## PATENT PENDING

- Part No. : MA1130.A.LBICGT.002
- Product Name : Raptor II - 6 in 1 Next Generation Dual Fin Permanent Mount External Antenna with GPS/GLONASS/BeiDou, LTE MIMO 1&2, Wi-Fi MIMO 1&2 and AM/FM
- Feature : **2 x 4G/3G/2G MIMO** Antenna (698~960MHz, 1710~2170MHz,2300~2700MHz )  
**1 x GPS/GLONASS/BeiDou** Antenna ( 1561/1575.42/1602MHz )  
**2 x Wi-Fi 2.4GHz/5.8GHz** MIMO Antenna  
MIMO2 antenna can be replaced by DSRC band  
**1 x AM/FM** Antenna  
IP67 Waterproof  
Front End SAW Filter  
High Efficiency/Peak Gain Outdoor Antenna  
SMA(M) and RP-SMA(M) Connectors as standard (Fakra Optional)  
0.3m RG-316 Cable as standard  
**RoHS Compliant**



## 1. Introduction

The Raptor II MA1130.A is a 6in1 next generation, dual fin, permanent screw mount antenna for vehicle roof applications. It is fully IP67 waterproof with a distinct quality dual fin high gloss finish housing that has passed highest automotive hardness testing levels to help prevent scratching. The 6 separate antennas inside support frequency bands in LTE, GPS/GLONASS/BeiDou, Wi-Fi, 4G/3G/2G and AM/FM radio.

This outstanding, patent pending, antenna delivers powerful MIMO antenna technology for LTE, Wi-Fi 2.4/5.8GHz 802.11n and the emerging 802.11ac, plus a high gain omnidirectional DSRC (V2V/V2X) 5.9GHz antenna, and an optimized GPS/GLONASS/BeiDou patch antenna for location.

The LTE antennas also include backward compatibility to work at most worldwide 2G and 3G bands.

Applications include:

- Next generation OEM car connectivity
- Multimedia, navigation and telematics systems
- V2V and V2X applications
- Fleet management
- Real-time HD video streaming
- E-Call

Examples of new uses that require such a highly sophisticated antenna are real-time streaming applications that demand high speed video uplink and downlink into the cabin of the car. These challenges are resolved by the highly efficient, high gain MIMO antennas, with high isolation, which is necessary to achieve the required signal to noise ratio and throughput.



The Raptor II can also be customized for your particular wireless application and frequency band, subject to NRE and MOQ.

The six standard cables are .3m RG-316, terminating in SMA(M) for GNSS, LTE MIMO 1&2, AM/FM, DSRC and RP SMA(M) for Wi-Fi.

Cable length and connector types are customizable. For short cable runs up to 1 meter, RG174 can be used. For longer cable runs it is recommended to use low loss CFD200 cable extensions.

Contact your regional Taoglas sales office for support.

## 2. Specification Table

4G/3G/2G MIMO							
Band	LTE 700	GSM 850	GSM 900	DCS	PCS	UMTS1	LTE 2600
Frequency (MHz)	698-824	824-894	880-960	1710-1880	1850-1990	1920-2170	2500-2690
MIMO 1							
Peak Gain (dBi) *	1.61	0.64	-0.23	4.00	3.54	3.40	5.69
Average Gain (dBi)*	-5.34	-4.49	-6.04	-3.88	-3.37	-3.57	-3.51
Efficiency (%)*	29.82	35.55	25.57	41.12	45.98	43.97	44.80
Return loss (dB) *	<-6	<-6	<-4	<-5	<-10	<-10	<-8
MIMO 2							
Peak Gain (dBi) *	0.26	1.44	0.53	3.74	3.98	4.08	6.12
Average Gain (dBi) *	-5.36	-4.21	-5.15	-4.18	-3.48	-3.59	-3.30
Efficiency (%) *	29.59	38.02	30.91	38.35	44.87	43.83	46.83
Return loss (dB) *	<-6	<-6	<-4	<-5	<-10	<-10	<-8
Polarization	Linear						
Impedance	50Ω						
Cable	30cm RG-316 standard, fully customizable						
Connector	SMA Male Straight, fully customizable						

2.4GHz/5.8GHz MIMO		
Frequency (GHz)	2.4~2.5	5.15~5.85
MIMO 1		
Peak Gain (dBi) *	3.43	2.92
Average Gain (dBi) *	-4.38	-4.23
Efficiency (%)*	36.57	37.75
Return loss (dB) *	<-10	<-6
MIMO 2		
Peak Gain (dBi) *	6.81	6.37
Average Gain (dBi) *	-2.86	-3.65
Efficiency (%)*	52.66	44.19
Return loss (dB) *	<-10	<-6
Polarization	Linear	
Impedance	50Ω	
Cable	30cm RG-316 standard, fully customizable	
Connector	SMA Male RP Straight, fully customizable	

DSRC	
Frequency (GHz)	5.850~5.925
Peak Gain (dBi) *	6.6
Average Gain (dBi) *	-3.81
Efficiency (%)*	41.69
Return loss (dB) *	<-10
Polarization	Linear
Impedance	50Ω
Cable	30cm RG-316 standard, fully customizable
Connector	SMA Male Straight, fully customizable

GPS/GLONASS/BeiDou			
Center Frequency fc	BeiDou:1561.098 ± 2MH	GPS:1575.42±3 MHz	GLONASS:1602±0.5 MHz
Gain	-1 dBi typ.	-2.5 dBi typ.	-1.5 dBi typ.
VSWR(@Center Frequency)	< 2		
Polarization	RHCP		
Impedance	50Ω		
Antenna size	25*25*4mm		
Cable	30cm RG-316 standard, fully customizable		
Connector	SMA Male Straight, fully customizable		
LNA Electrical Properties			
Frequency	1558~1610MHz		
Gain @3V	28 dB typical		
DC Power Input	3V		
Noise Figure @3V	2.8dB		
Power Consumption @3V	10 mA		

MECHANICAL	
Antenna Dimensions	176.2*84.5*70.8mm ( L*W*H )
Housing	PC
Waterproof	IP67
Base	Aluminum
Thread diameter	M20 x 1.5P
Nut	Nickel Plated Steel
ENVIRONMENTAL	
Operation Temperature	-40°C to 85°C
Storage Temperature	-40°C to 90°C
Humidity	Non-condensing 65°C 95% RH

\* All measurements were conducted with 30cm cable length

### 3. LTE MIMO

#### 3.1. LTE MIMO1 and 2 Characteristics

##### 3.1.1. Return Loss on 30\*30cm GND

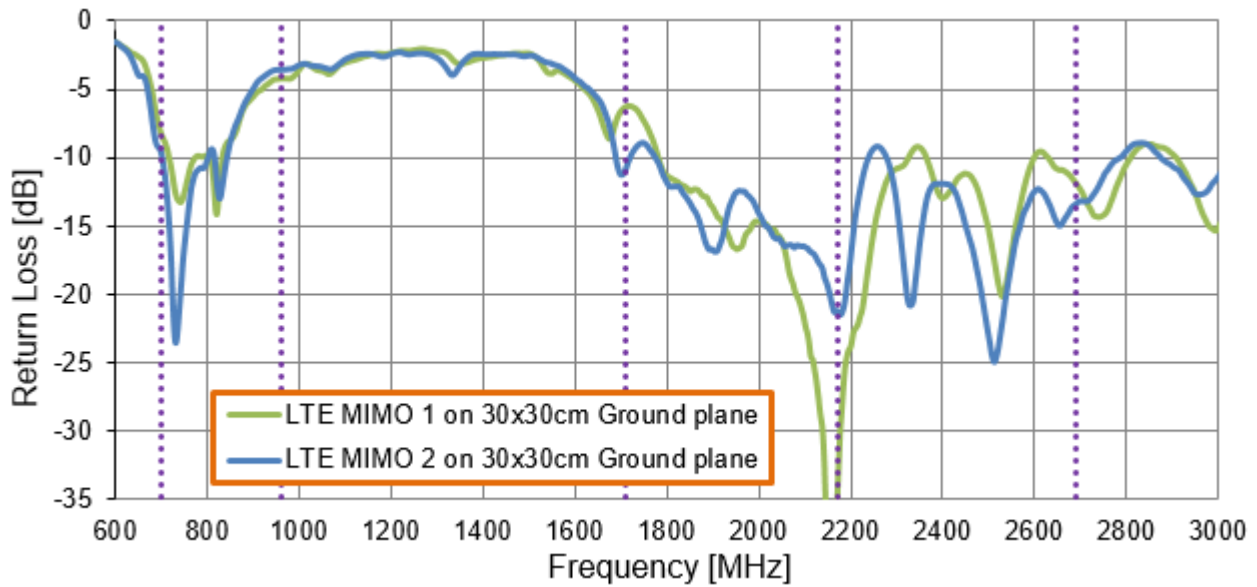

##### 3.1.2. Efficiency on 30\*30cm GND

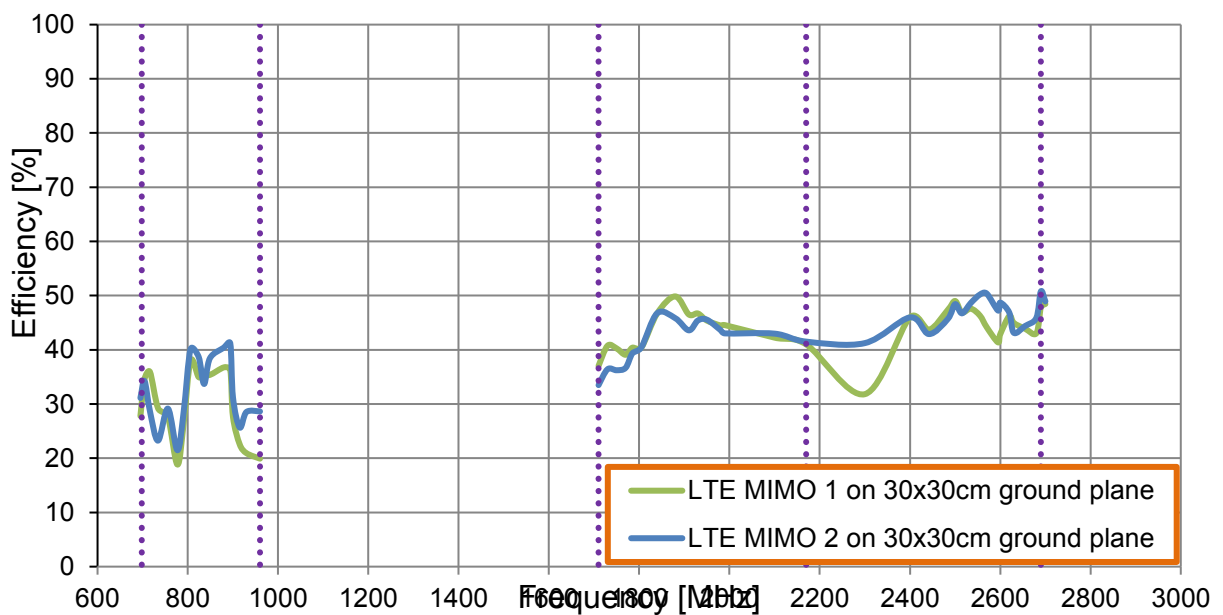

### 3.1.3. Peak Gain on 30\*30cm GND

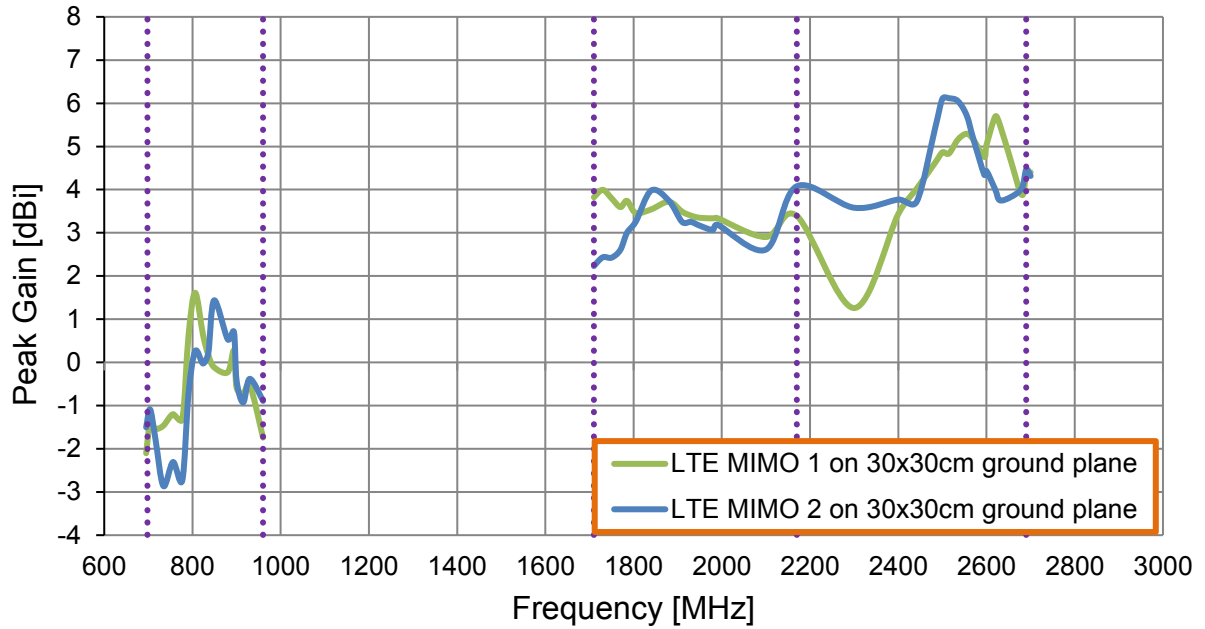

### 3.1.4. Average Gain on 30\*30cm GND

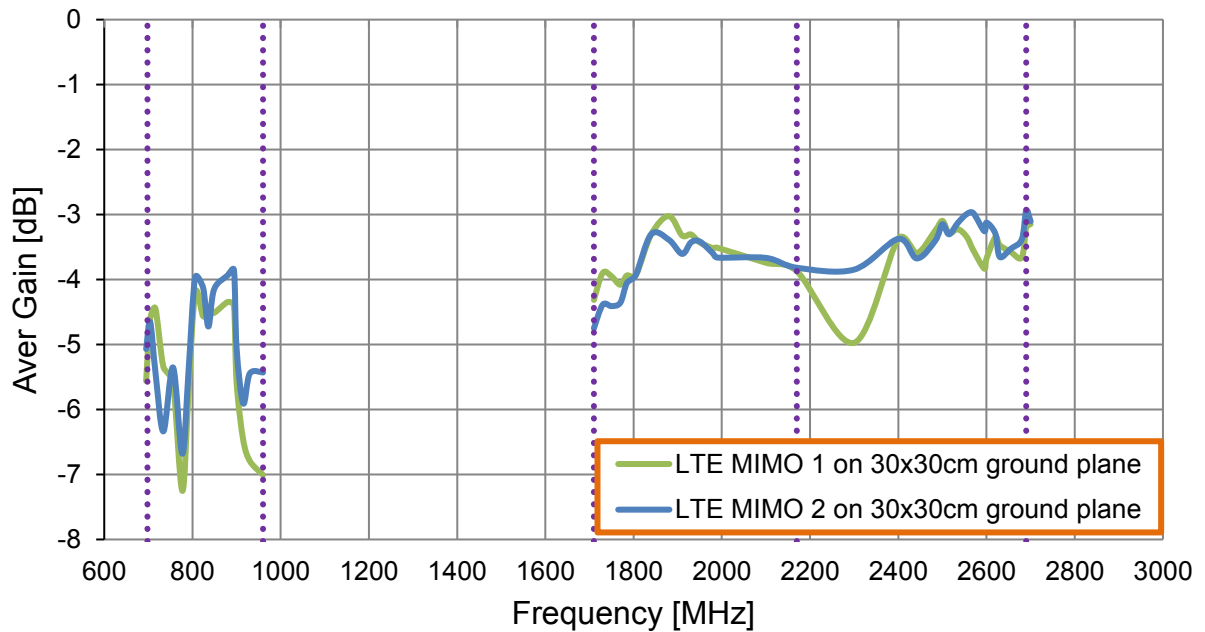



### 3.2. LTE Characteristics with different cable length

#### 3.2.1. MIMO 1 Efficiency

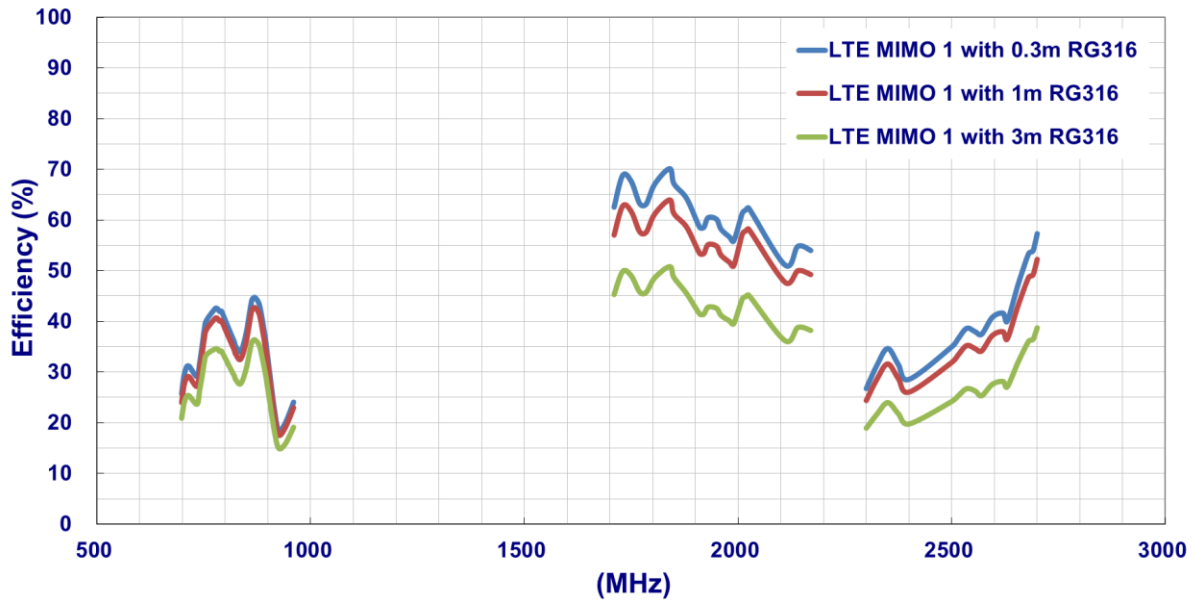

#### 3.2.2. MIMO 1 Peak Gain

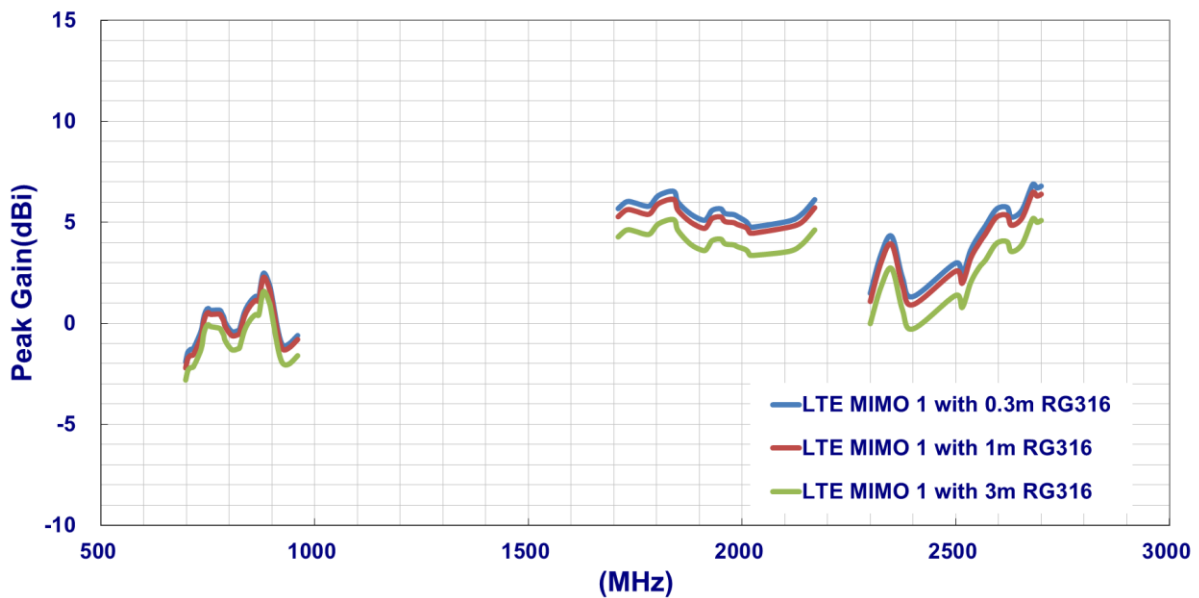

### 3.2.3. MIMO 1 Average Gain

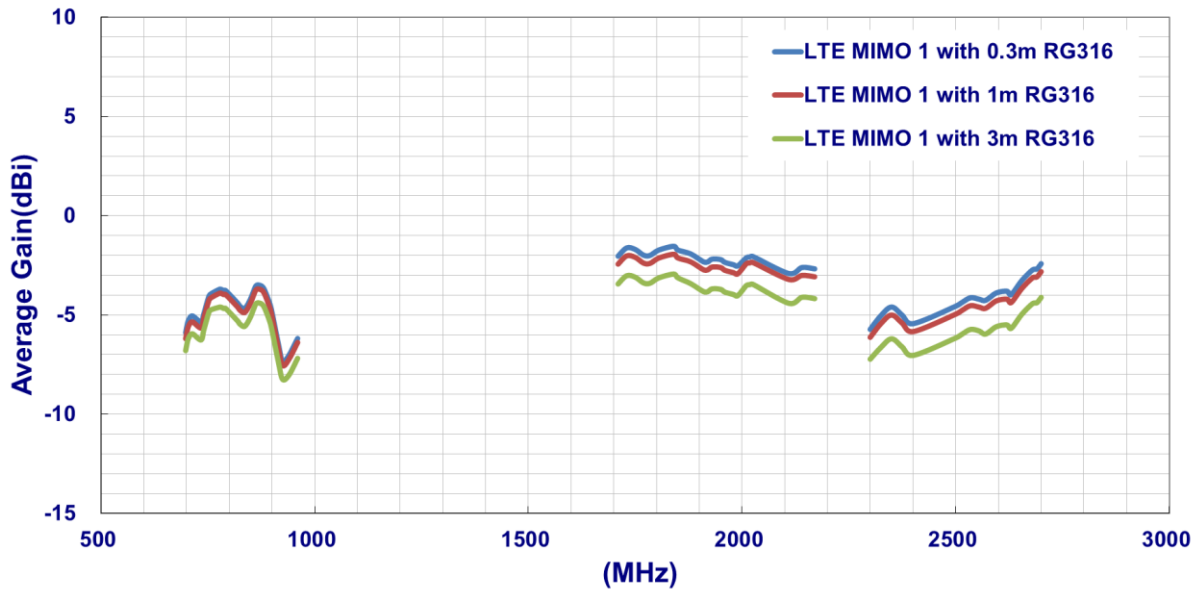

### 3.2.4. MIMO 2 Efficiency

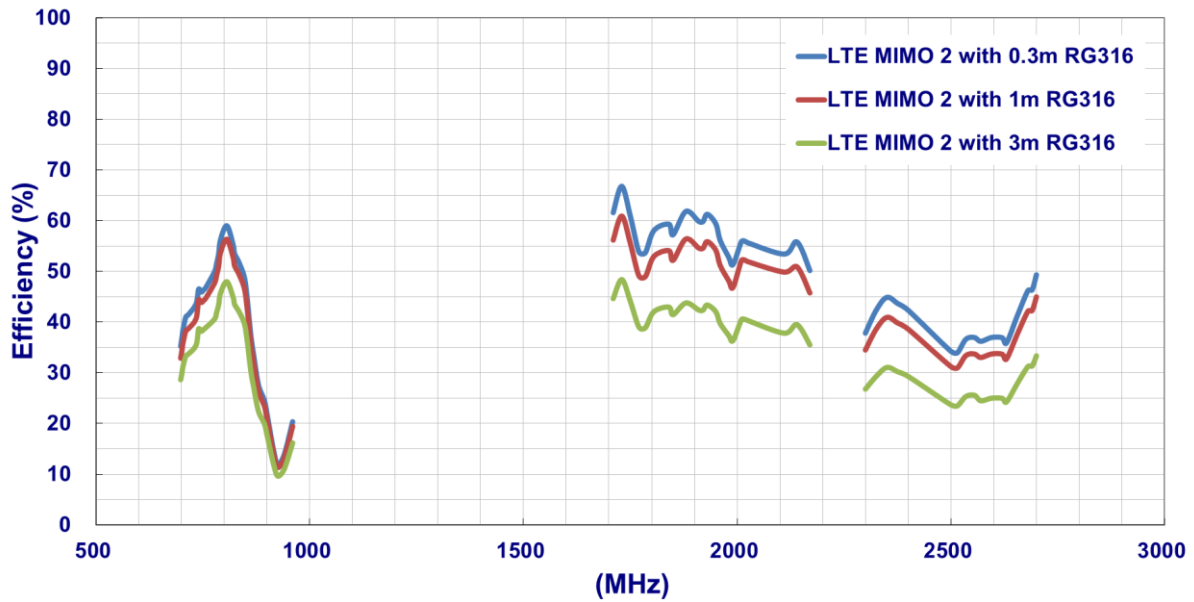

### 3.2.5. MIMO 2 Peak Gain

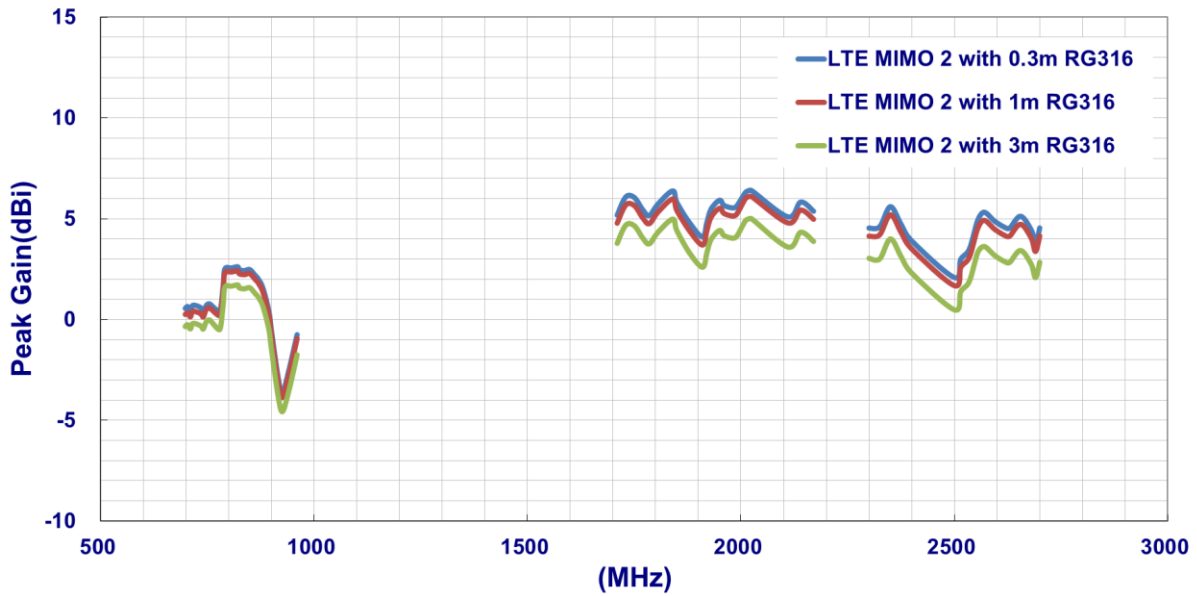

### 3.2.6. MIMO 2 Average Gain

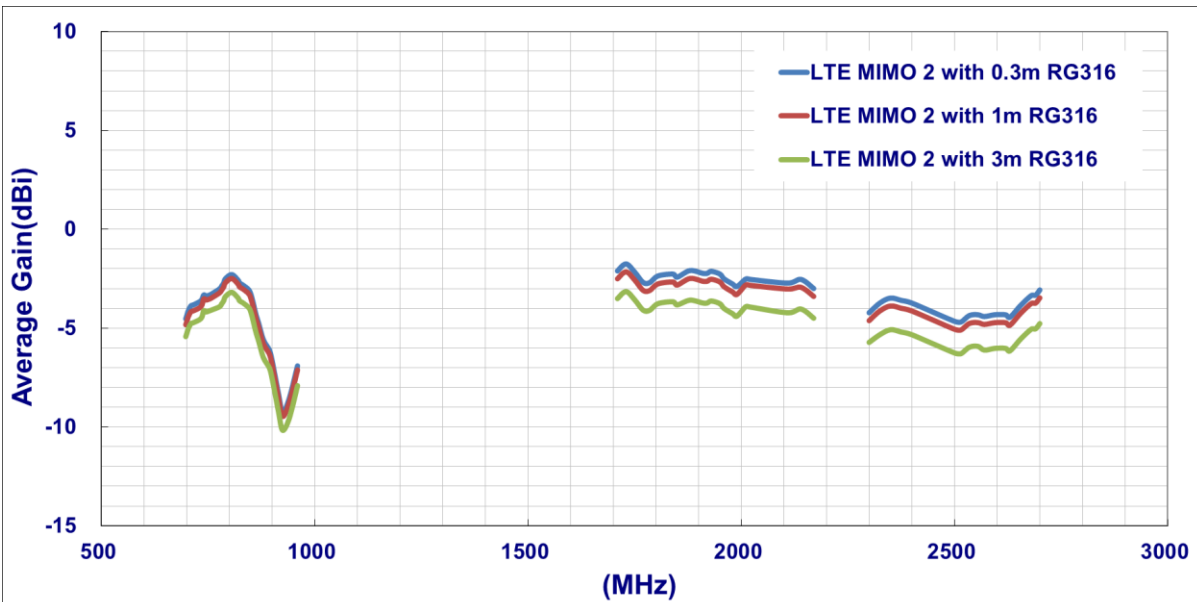

### 3.3. 3D Radiation Pattern

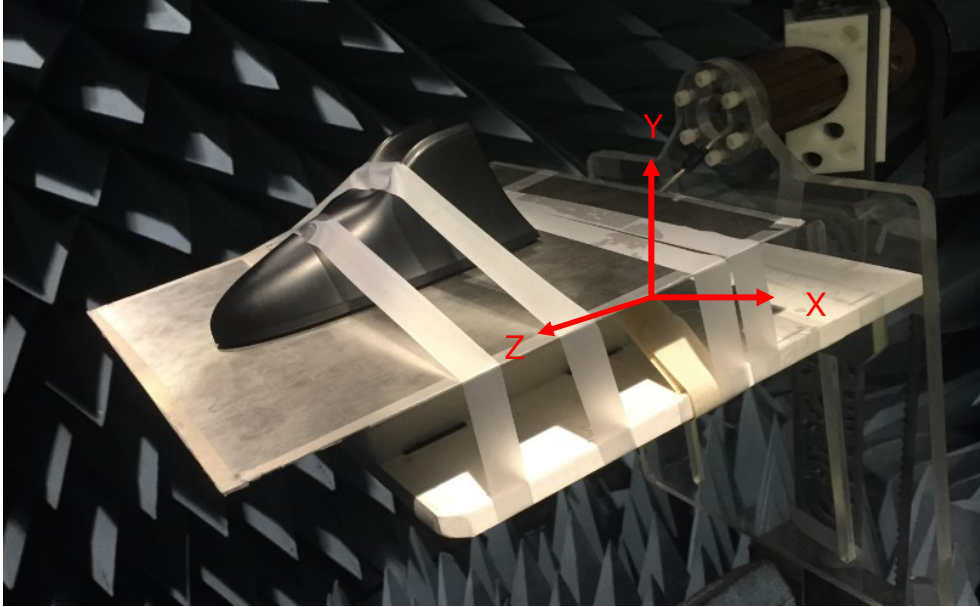

### 3.3.1. LTE MIMO1 3D Radiation Pattern

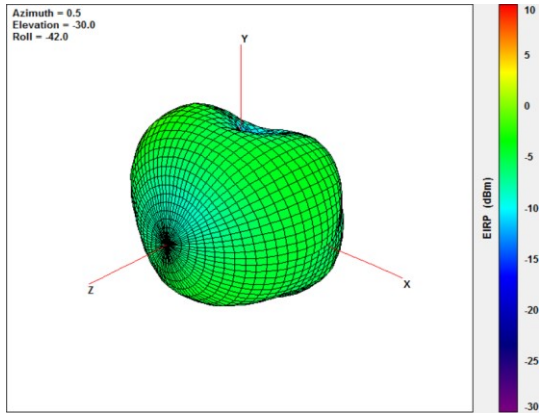

@756MHz

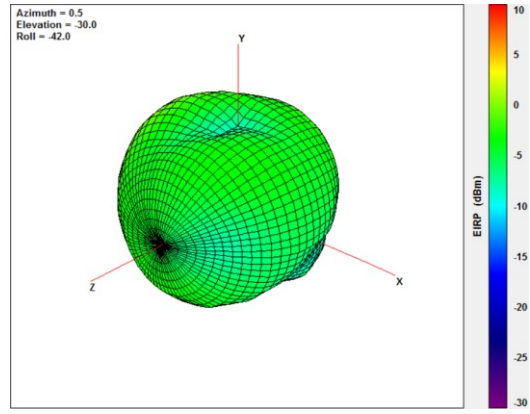

@824MHz

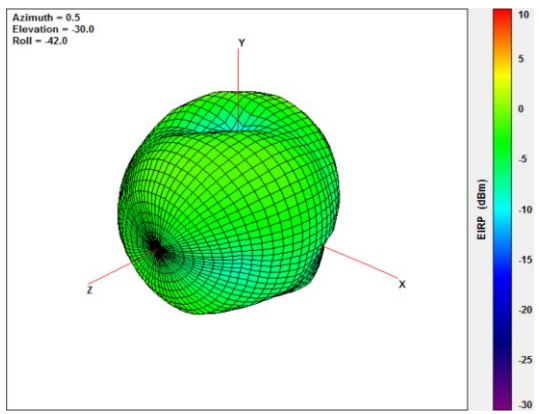

@880MHz

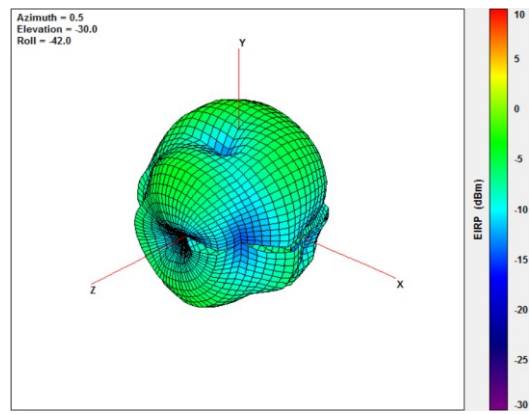

@960MHz

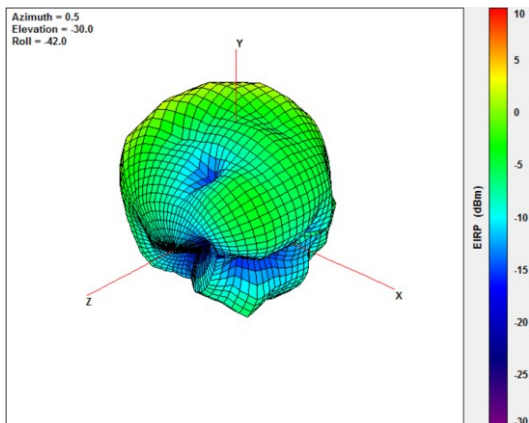

@1710MHz

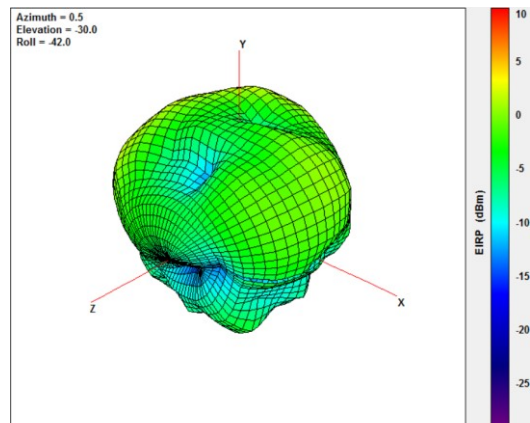

@1880MHz

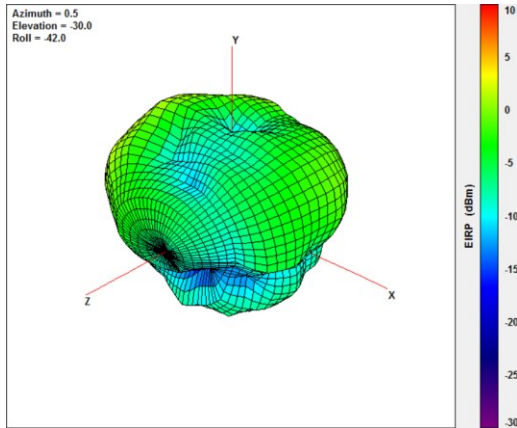

@1990MHz

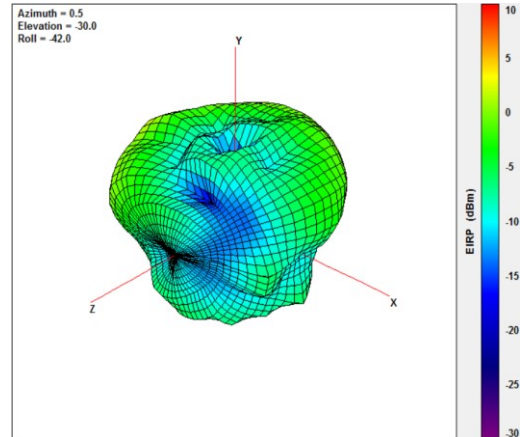

@2170MHz

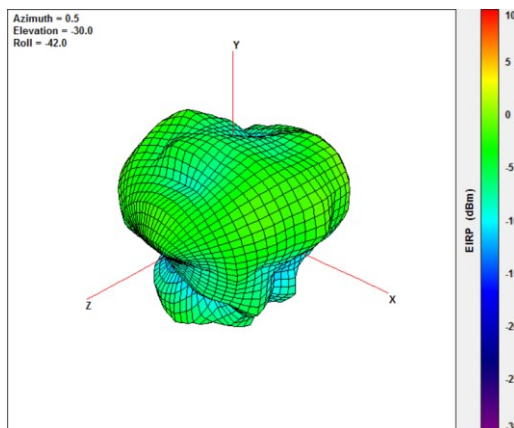

@2300MHz

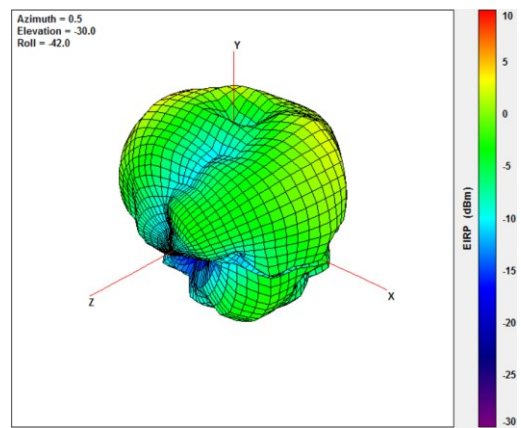

@2500MHz

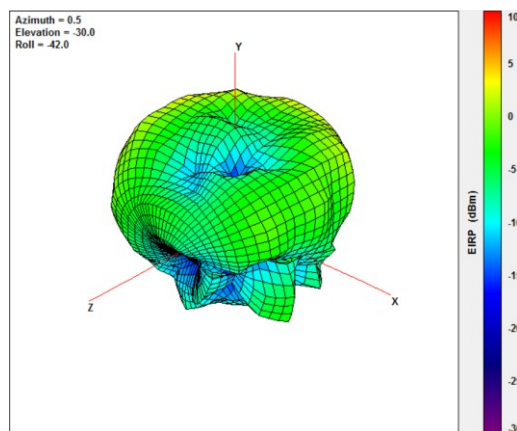

@2290MHz

### 3.3.2. LTE MIMO2 3D Radiation Pattern

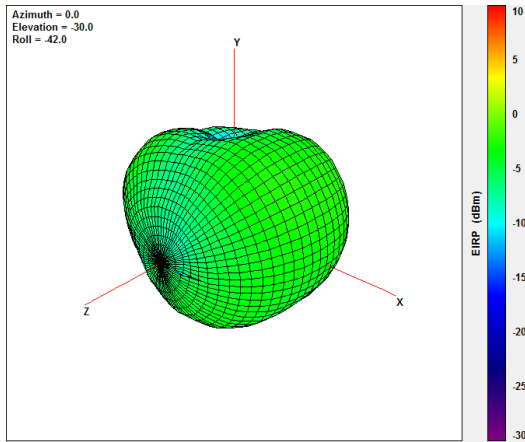

@756MHz

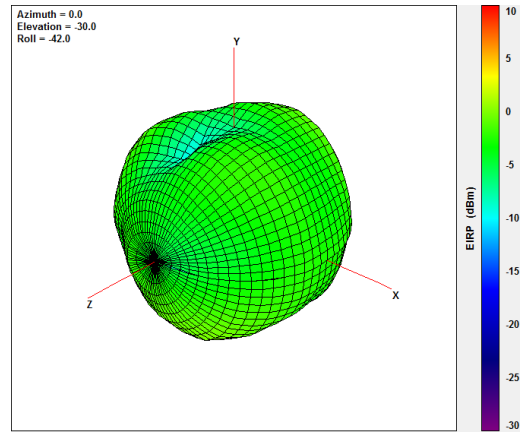

@824MHz

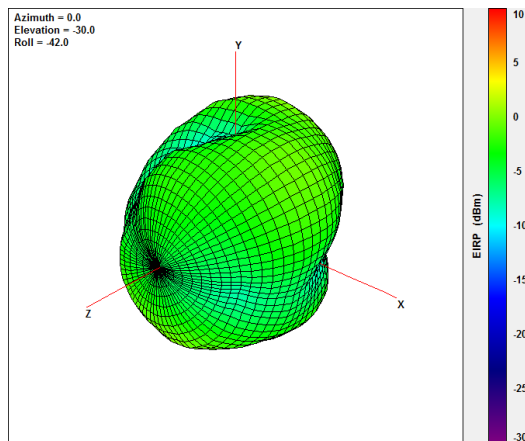

@880MHz

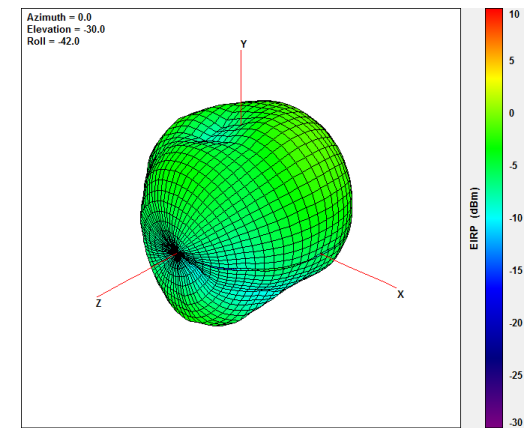

@960MHz

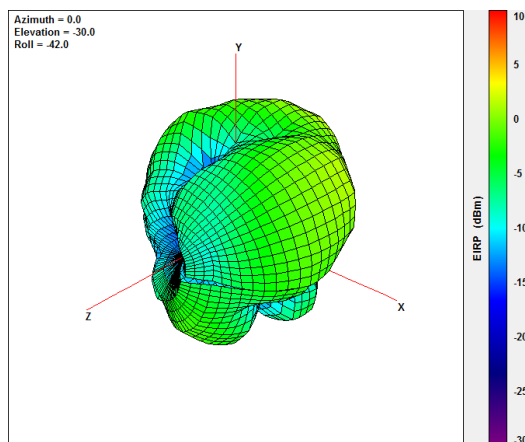

@1710MHz

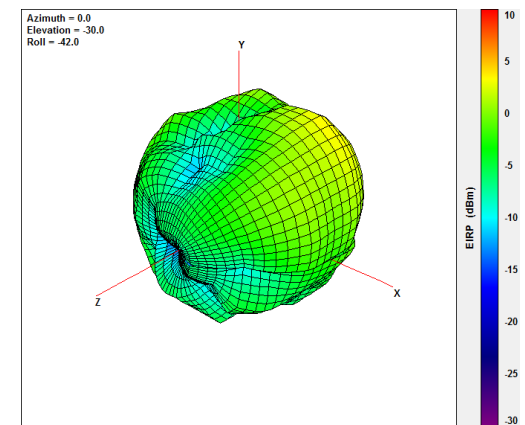

@1880MHz



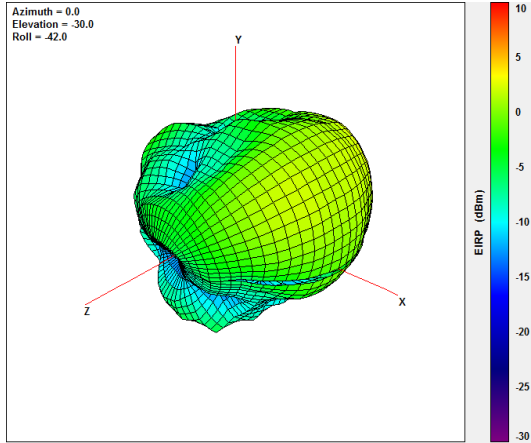

@1990MHz

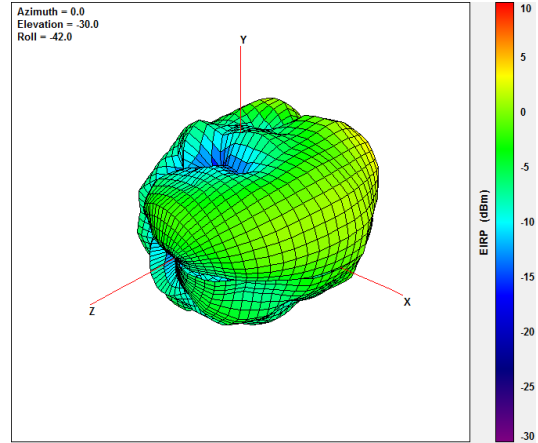

@2170MHz

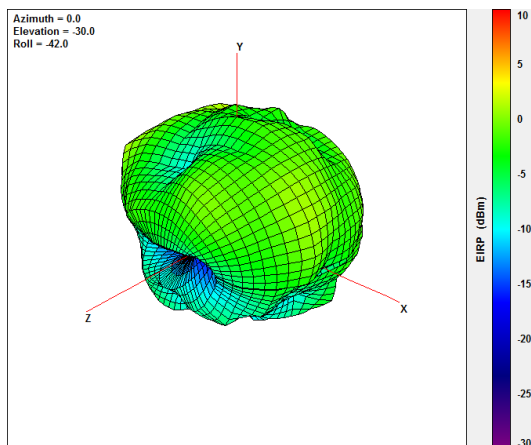

@2300MHz

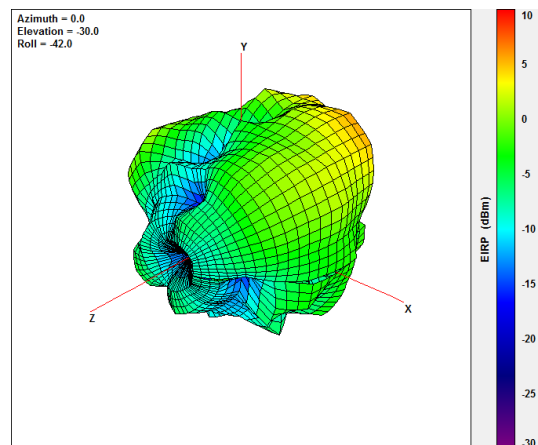

@2500MHz

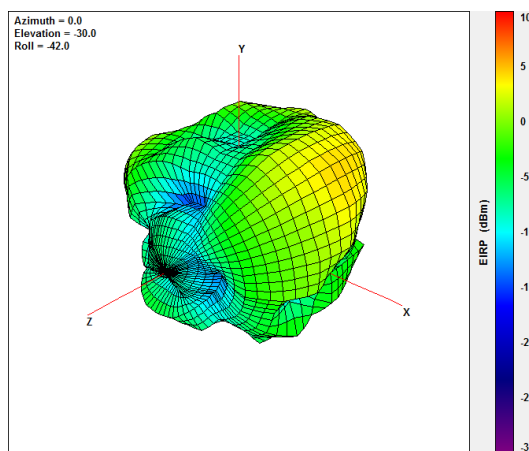

@2690MHz



## 4. Wi-Fi 2.4/5.8GHz

### 4.1. Wi-Fi 2.4/5.8GHz Characteristics

#### 4.1.1. Return Loss on 30\*30cm GND

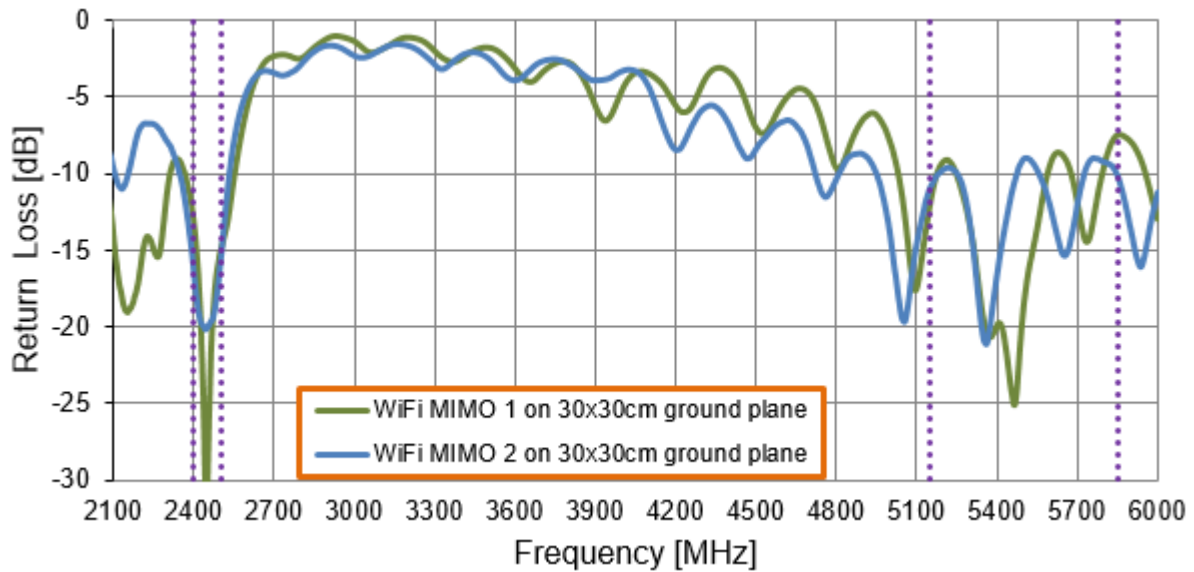

#### 4.1.2. Isolation on 30\*30cm GND

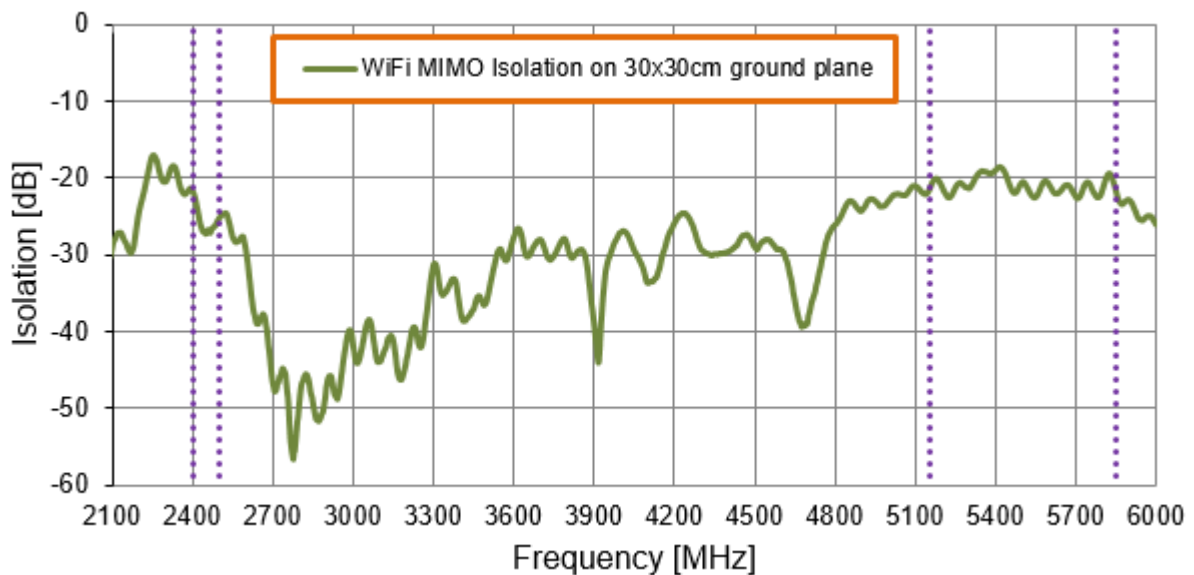

### 4.1.3. Average Gain on 30\*30cm GND

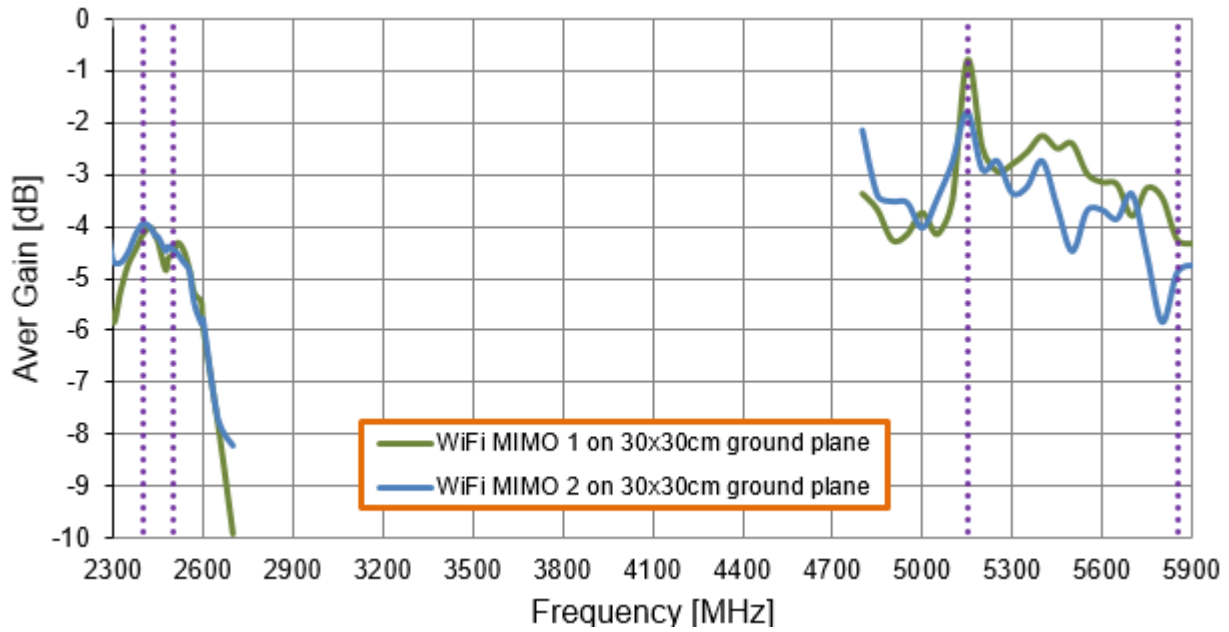

### 4.1.4. Peak Gain on 30\*30cm GND

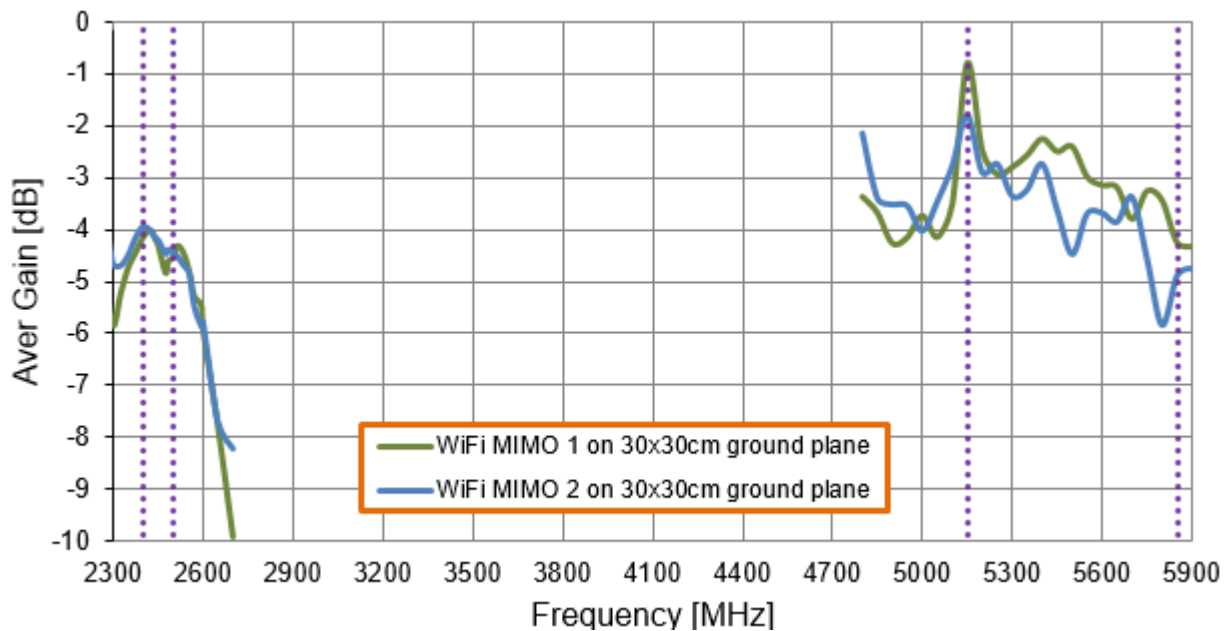

#### 4.1.5. Efficiency on 30\*30cm GND

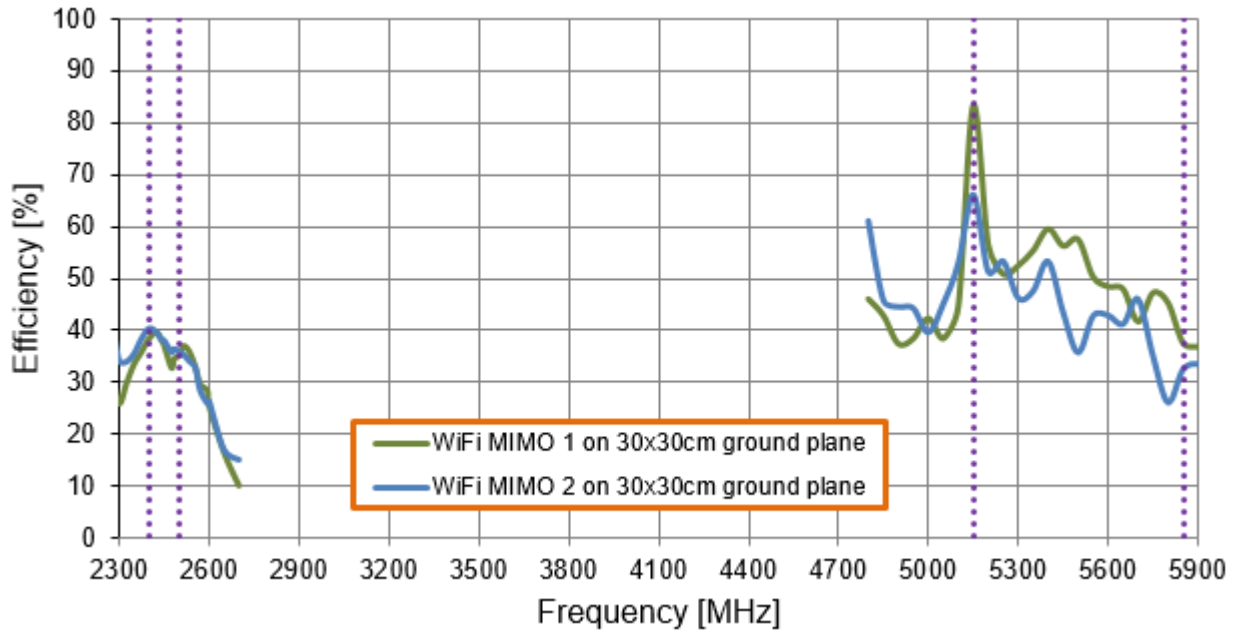

## 4.2. Wi-Fi Characteristics with different cable length

### 4.2.1. Average Gain

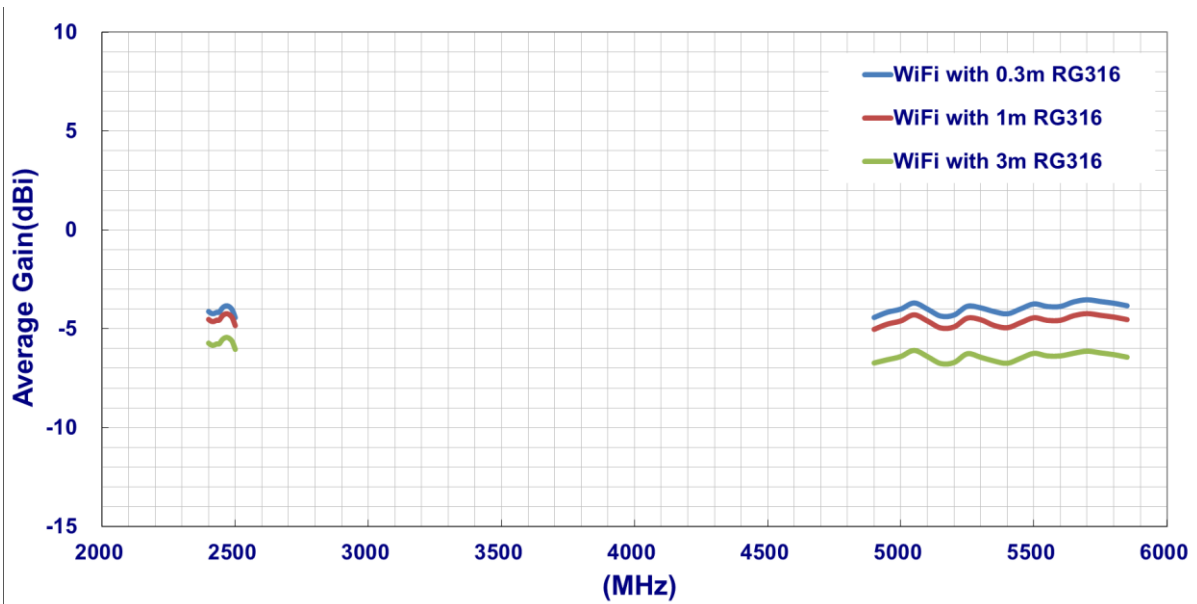

### 4.2.2. Peak Gain

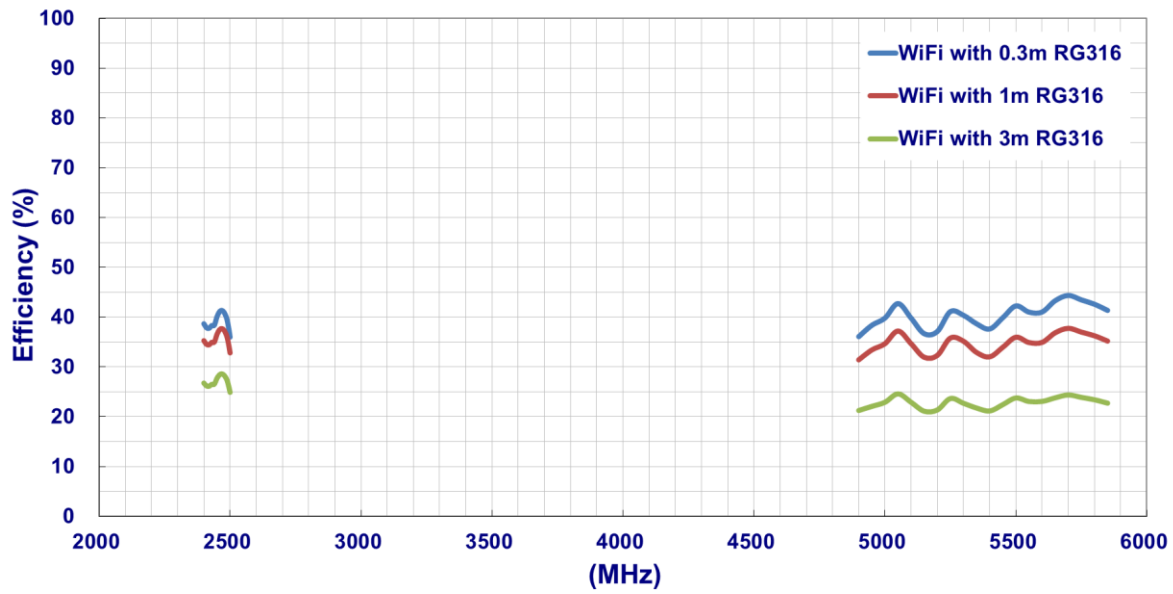

### 4.2.3. Efficiency

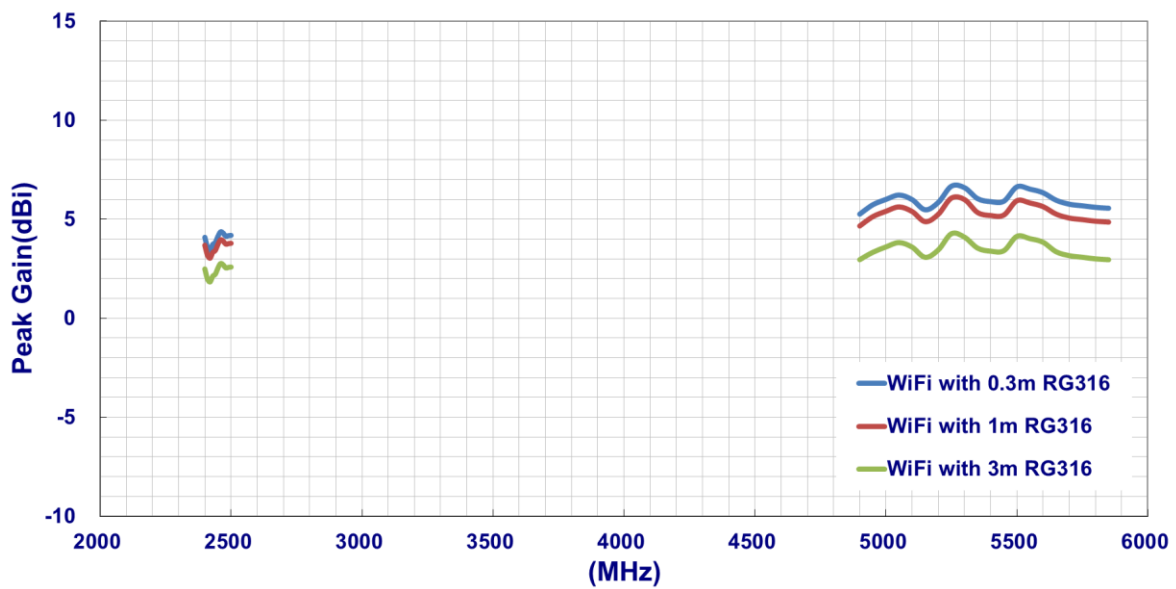

### 4.3. 3D Radiation Patterns

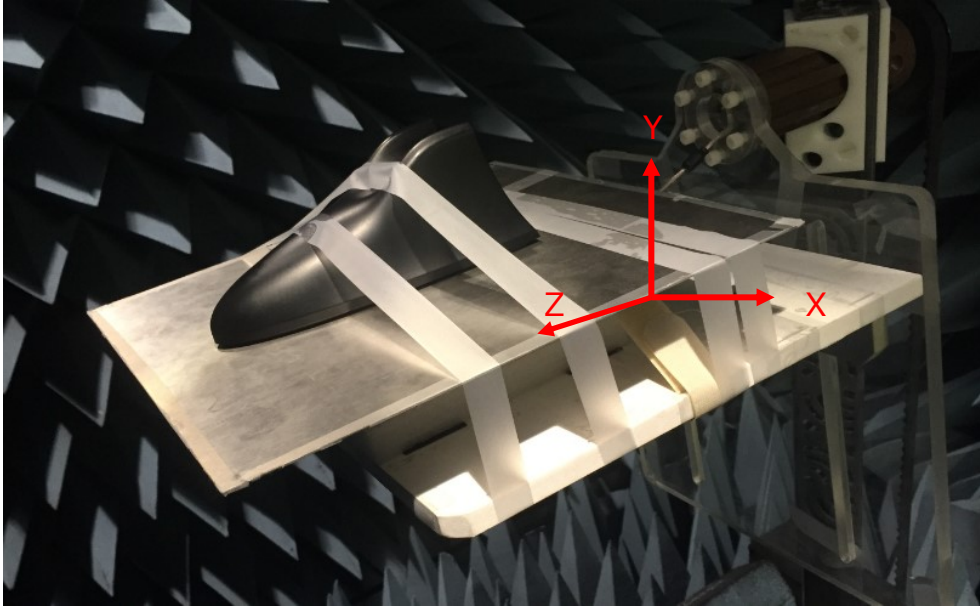

### 4.3.1. Wi-Fi 2.4/5.8GHz 3D Radiation Pattern

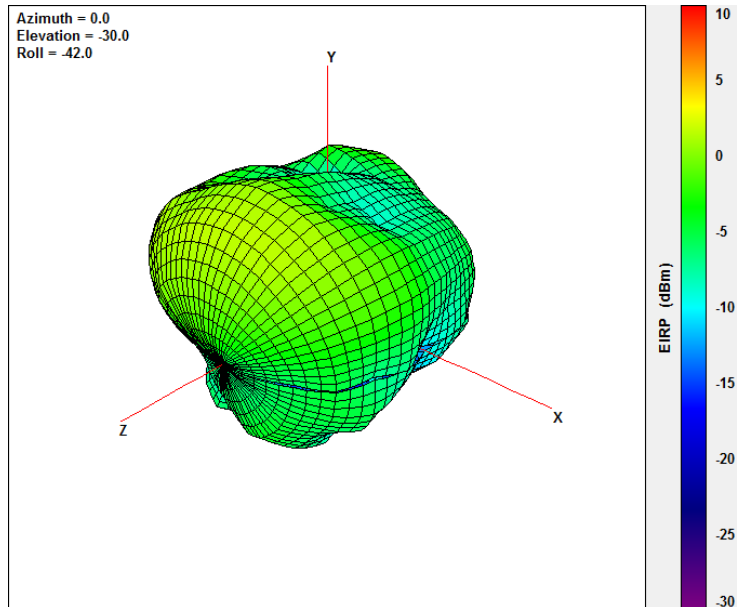

@2450MHz

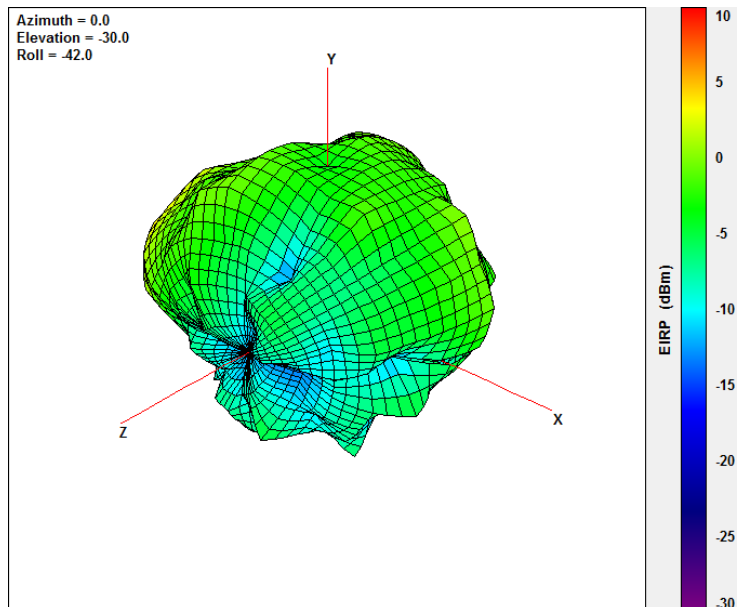

@5550MHz

### 4.3.2. 2.4/5.8GHz MIMO2 3D Radiation Pattern

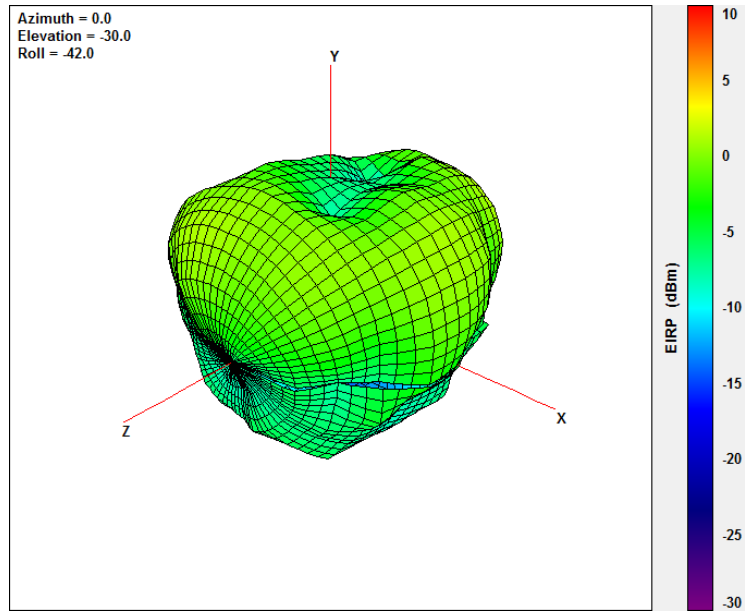

@2450MHz

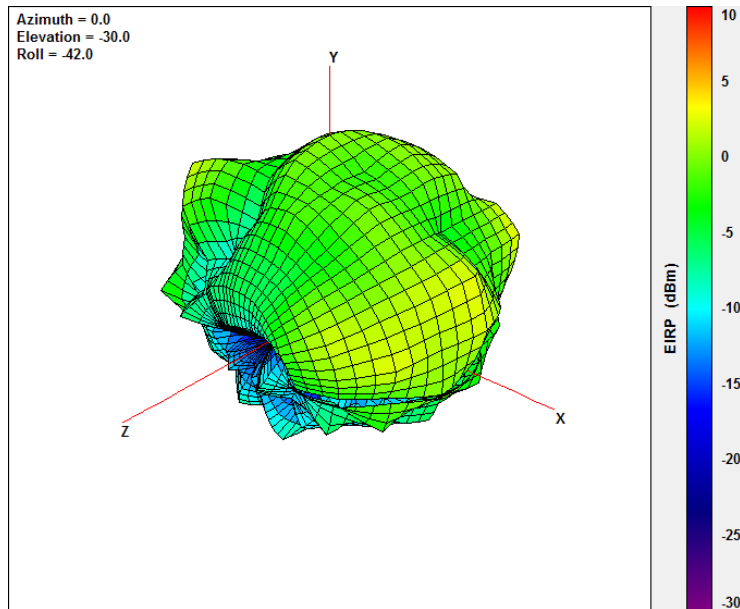

@5550MHz

## 5. DSRC 5.9GHz

### 5.1. DSRC 5.9GHz Characteristics

#### 5.1.1. Average Gain on 50\*50cm GND

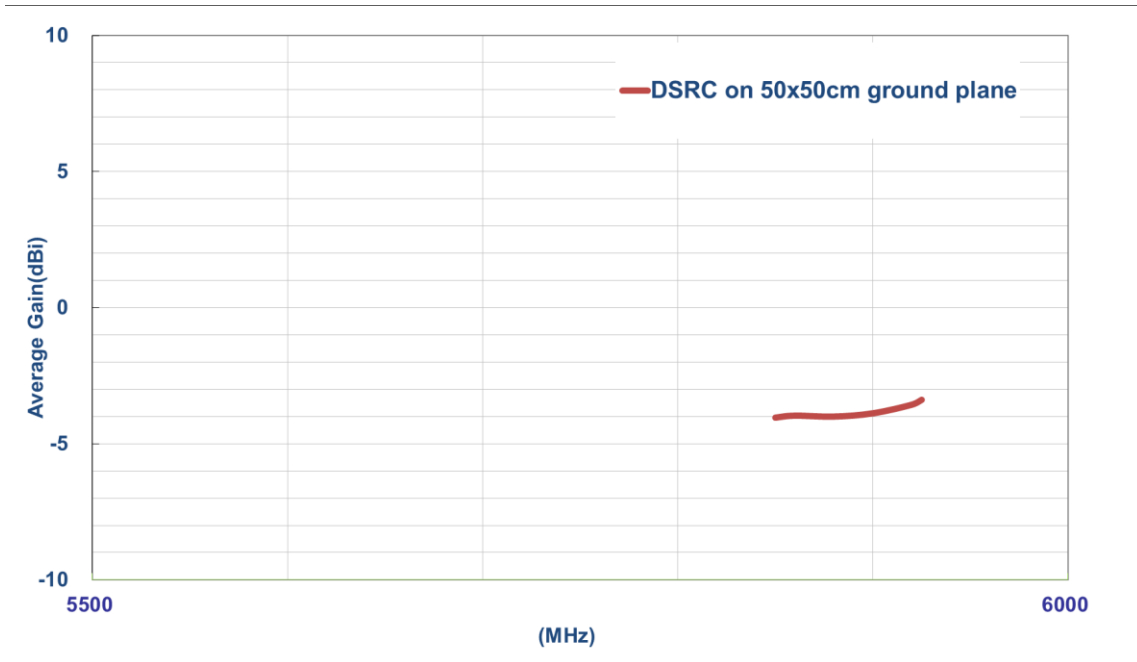

#### 5.1.2. Peak Gain on 50\*50cm GND

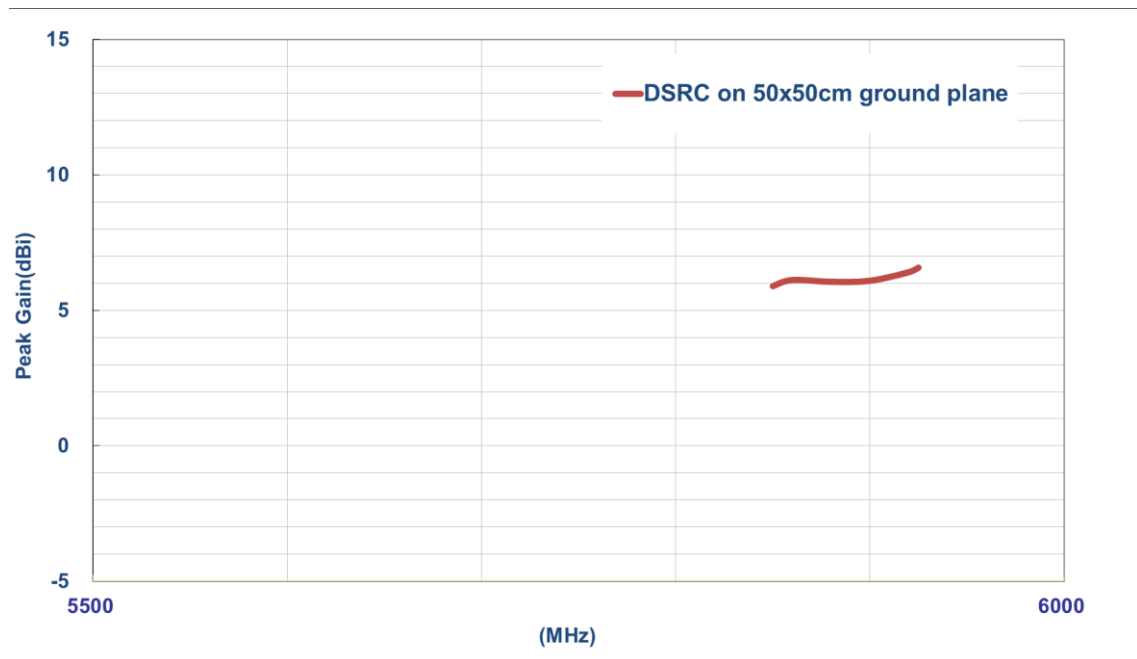



### 5.1.3. Efficiency on 50\*50cm GND

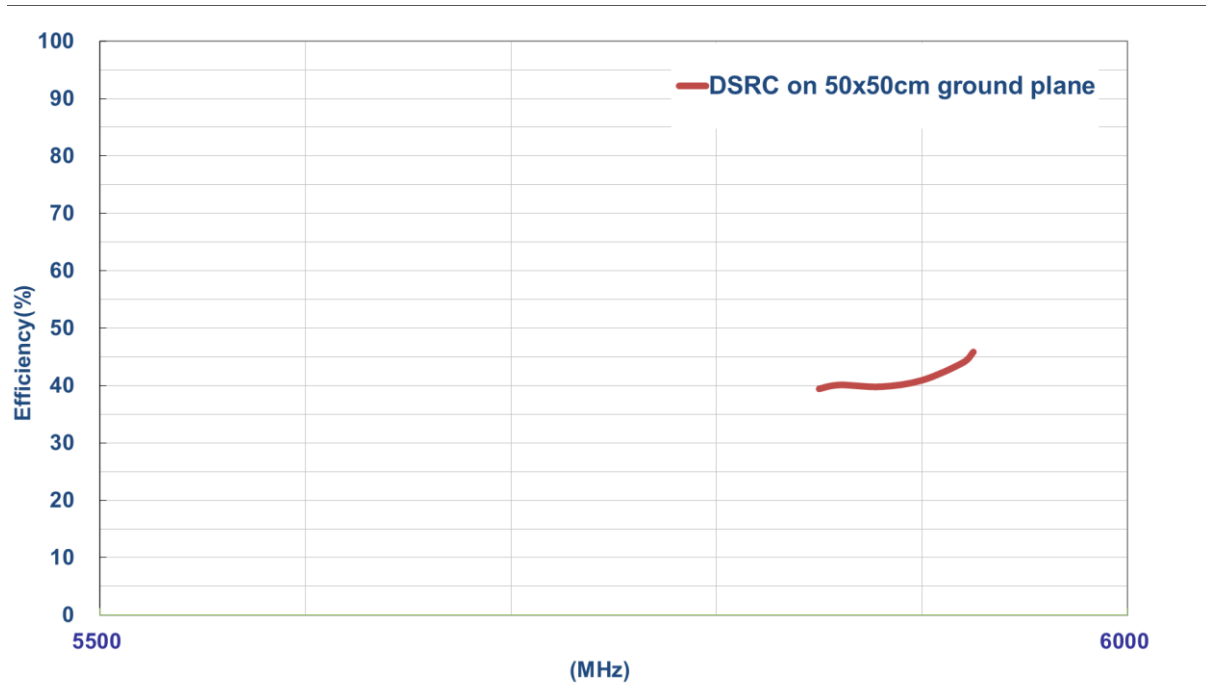

## 5.2. DSRC Characteristics with different cable length

### 5.2.1. Average Gain

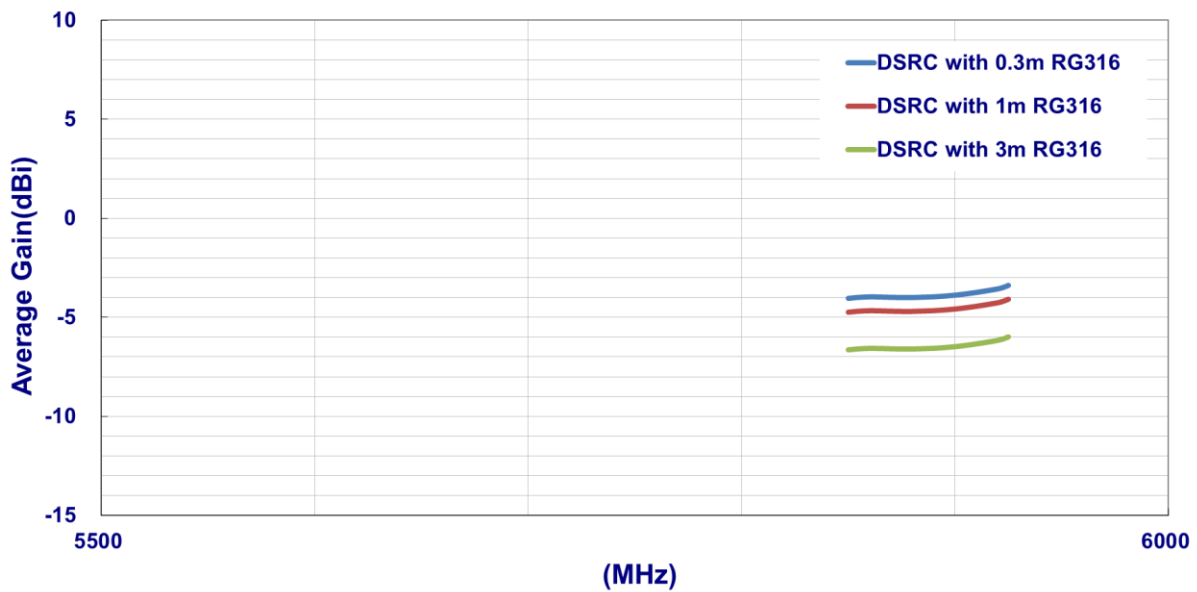

### 5.2.2. Peak Gain

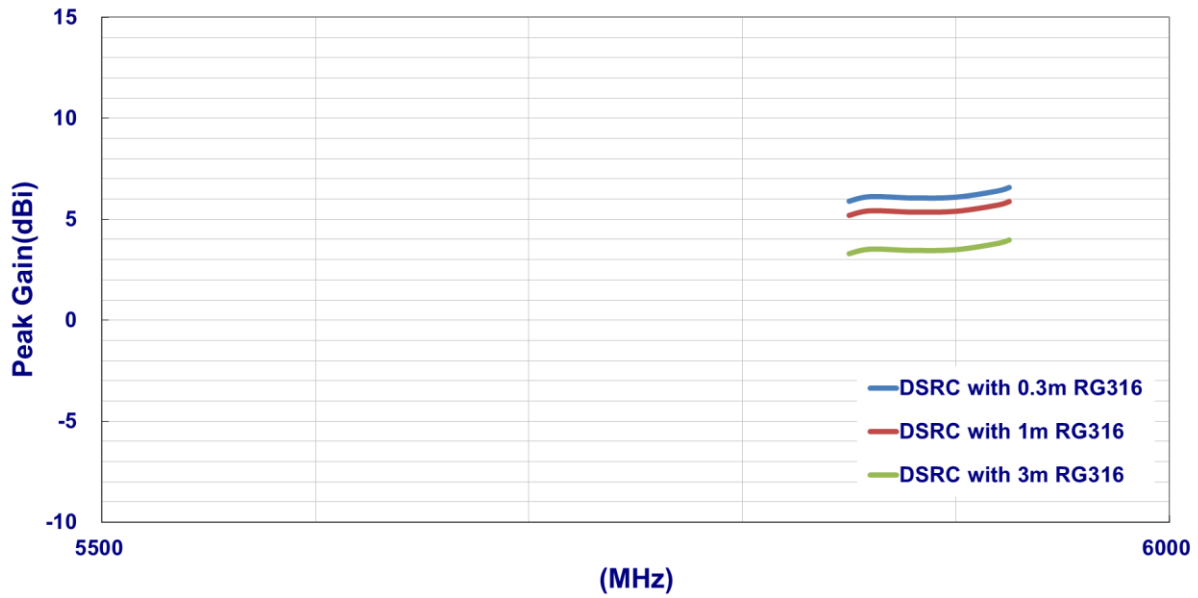

### 5.2.3. Efficiency

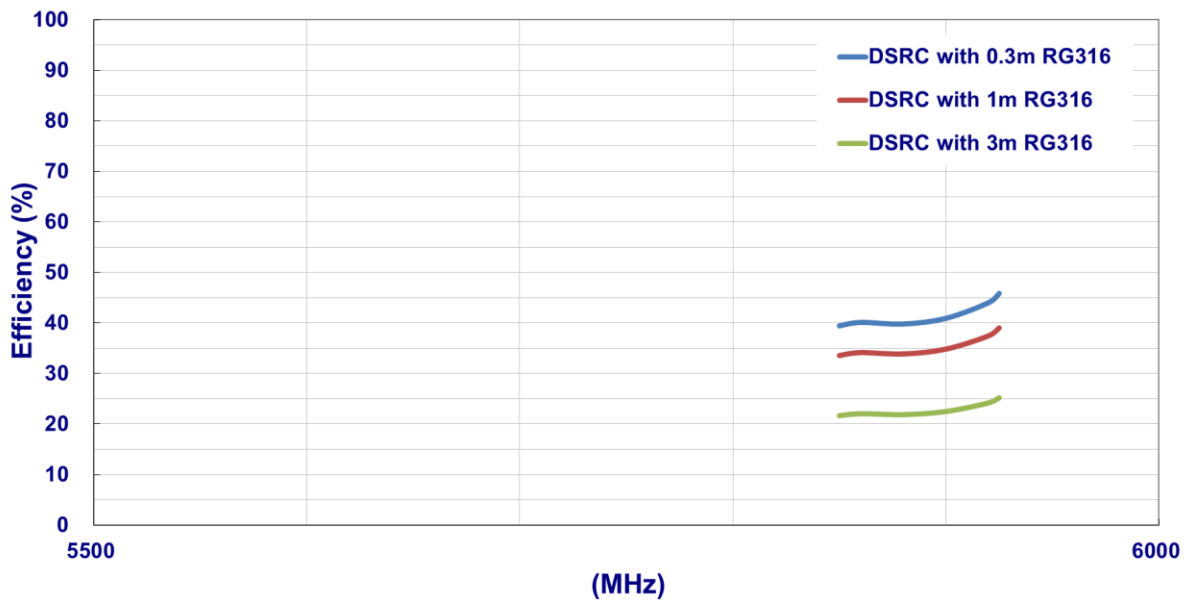



## 6. Drawing

Front View

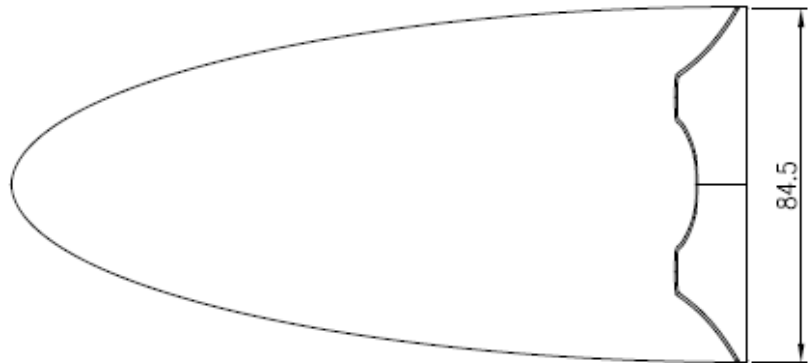

Side View

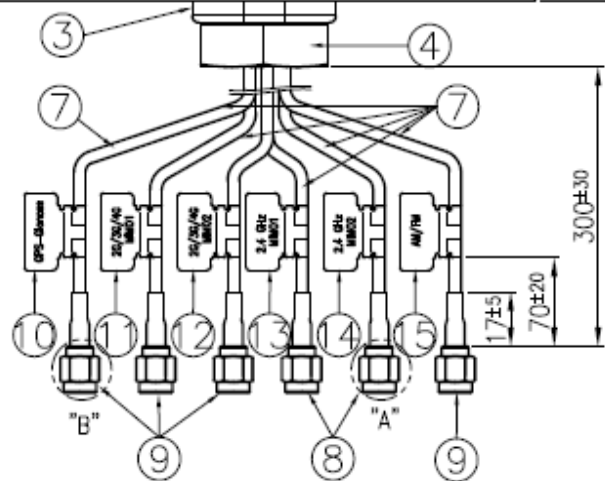
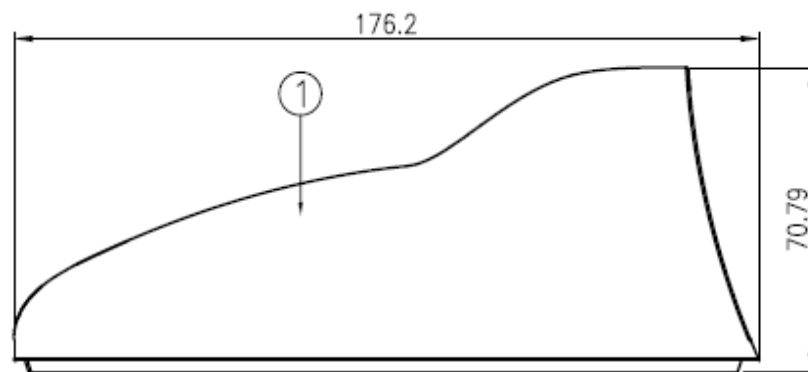



Back View

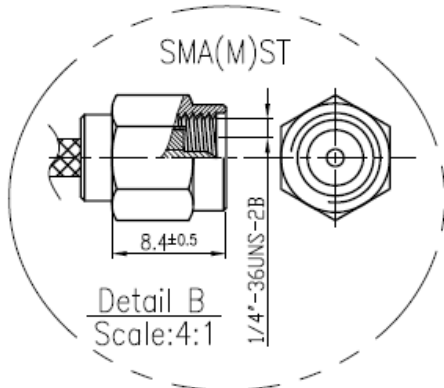
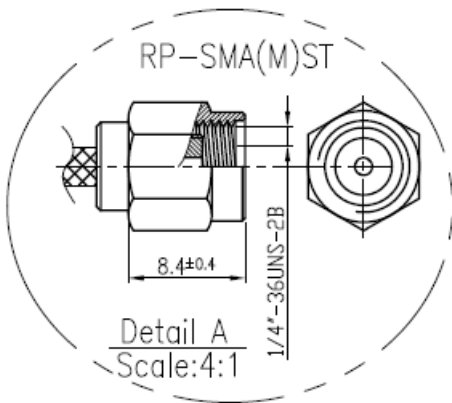
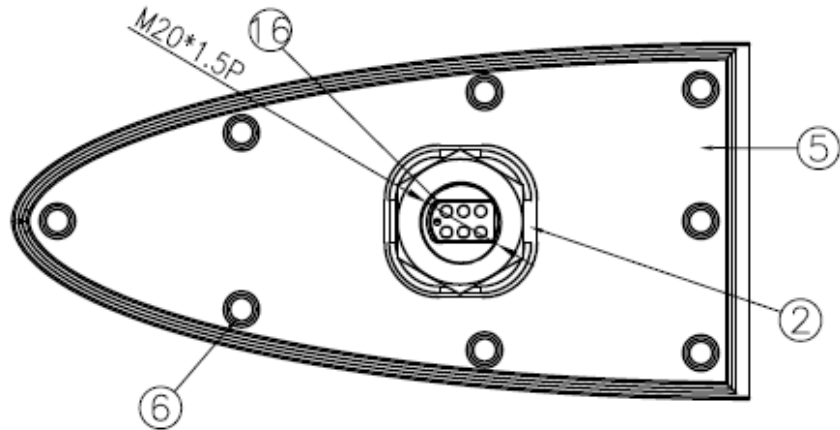

	Name	Material	Finish	QTY
1	Housing	PC	Black	1
2	Base	Aluminum	Natural	1
3	Spacer	POM	Black	1
4	Nut	Steel	Ni Plated	1
5	Rubber	Silicon Rubber	Black	1
6	Screw TP-1 $\phi$ 3x14	Steel	Ni Plated	8
7	RG316 Coaxial Cable	FEP	Brown	6
8	RP-SMA(M)ST	Brass	Gold	2
9	SMA(M)ST	Brass	Gold	4
10	GPS-Glonass Label	Coated Paper	Orange	1
11	2G/3G/4G MIM01 Label	Coated Paper	Light Gray	1
12	2G/3G/4G MIM02 Label	Coated Paper	White	1
13	2.4 GHz MIM01 Label	Coated Paper	Sea Green	1
14	2.4 GHz MIM02 Label	Coated Paper	Forest Green	1
15	AM/FM Label	Coated Paper		1
16	Rubber	Silicon Rubber	Black	1



## 7. Packaging

### MA1130.A.LBICGT.001 Packaging Specifications

1 pcs MA850.A.LBICG.002 per Blister Top Cover  
Blister Top Dimensions - 211 x 110 x 85mm  
Weight - 390g

16 pcs MA1130.A.LBICGT.001 per carton  
Carton - 570 x 510 x 345mm  
Weight - 10.8Kg

Pallet Dimensions 1140 x 1020 x 1200mm  
12 Cartons per Pallet  
6 Cartons per layer  
2 Layers

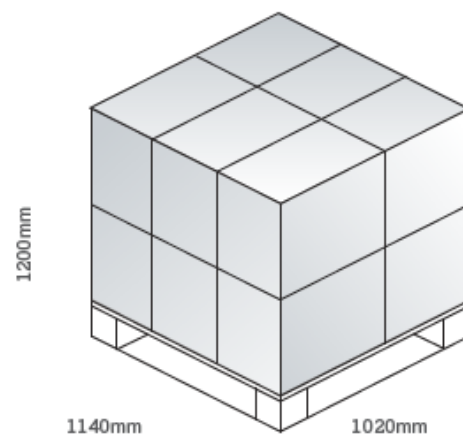
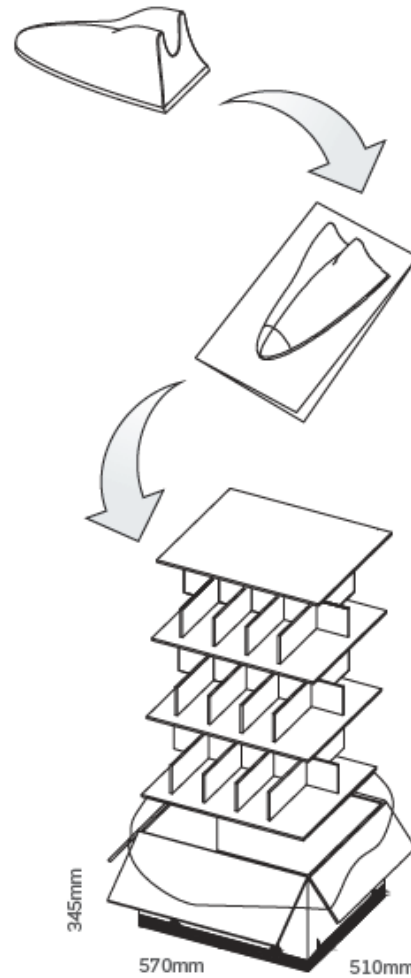



Taoglas makes no warranties based on the accuracy or completeness of the contents of this document and reserves the right to make changes to specifications and product descriptions at any time without notice. Taoglas reserves all rights to this document and the information contained herein.

Reproduction, use or disclosure to third parties without express permission is strictly prohibited.

Copyright © Taoglas Ltd.