

# DATA SHEET

## **BLF521** UHF power MOS transistor

Product specification

November 1992

# UHF power MOS transistor

# BLF521

### FEATURES

- High power gain
- Easy power control
- Gold metallization
- Good thermal stability
- Withstands full load mismatch
- Designed for broadband operation.

### DESCRIPTION

Silicon N-channel enhancement mode vertical D-MOS transistor designed for communications transmitter applications in the UHF frequency range.

The transistor is encapsulated in a 4-lead, SOT172D studless envelope, with a ceramic cap. All leads are isolated from the mounting base.

### PIN CONFIGURATION

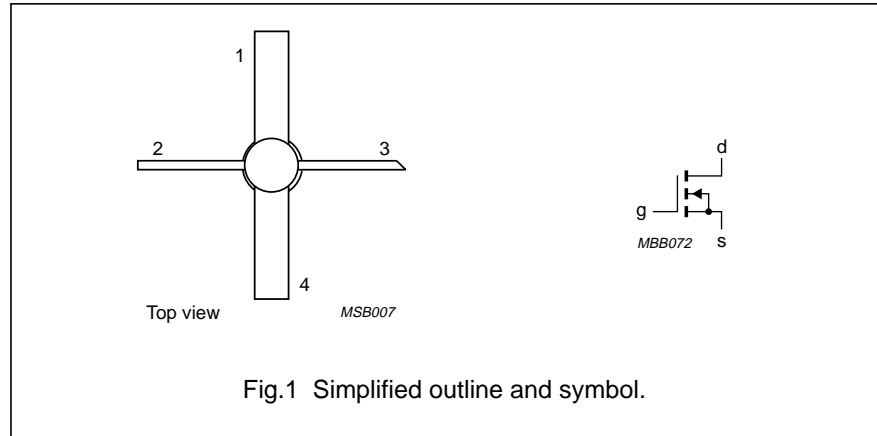

### CAUTION

The device is supplied in an antistatic package. The gate-source input must be protected against static charge during transport and handling.

### WARNING

**Product and environmental safety - toxic materials**

This product contains beryllium oxide. The product is entirely safe provided that the BeO disc is not damaged. All persons who handle, use or dispose of this product should be aware of its nature and of the necessary safety precautions. After use, dispose of as chemical or special waste according to the regulations applying at the location of the user. It must never be thrown out with the general or domestic waste.

### PINNING - SOT172D

PIN	DESCRIPTION
1	source
2	gate
3	drain
4	source

### QUICK REFERENCE DATA

RF performance at  $T_{amb} = 25\text{ }^{\circ}\text{C}$  in a common source test circuit.

MODE OF OPERATION	f (MHz)	$V_{DS}$ (V)	$P_L$ (W)	$G_p$ (dB)	$\eta_D$ (%)
CW, class-B	500	12.5	2	> 10	> 50

# UHF power MOS transistor

BLF521

## LIMITING VALUES

In accordance with the Absolute Maximum System (IEC 134).

SYMBOL	PARAMETER	CONDITIONS	MIN.	MAX.	UNIT
$V_{DS}$	drain-source voltage		–	40	V
$\pm V_{GS}$	gate-source voltage		–	20	V
$I_D$	DC drain current		–	1	A
$P_{tot}$	total power dissipation	up to $T_{mb} = 25\text{ }^\circ\text{C}$	–	10	W
$T_{stg}$	storage temperature		–65	150	$^\circ\text{C}$
$T_j$	junction temperature		–	200	$^\circ\text{C}$

## THERMAL RESISTANCE

SYMBOL	PARAMETER	THERMAL RESISTANCE
$R_{th\ j-mb}$	thermal resistance from junction to mounting base	17.5 K/W
$R_{th\ j-a}$	thermal resistance from junction to ambient (note 1)	75 K/W

### Note

1. Mounted on printed circuit board, see Fig.12.

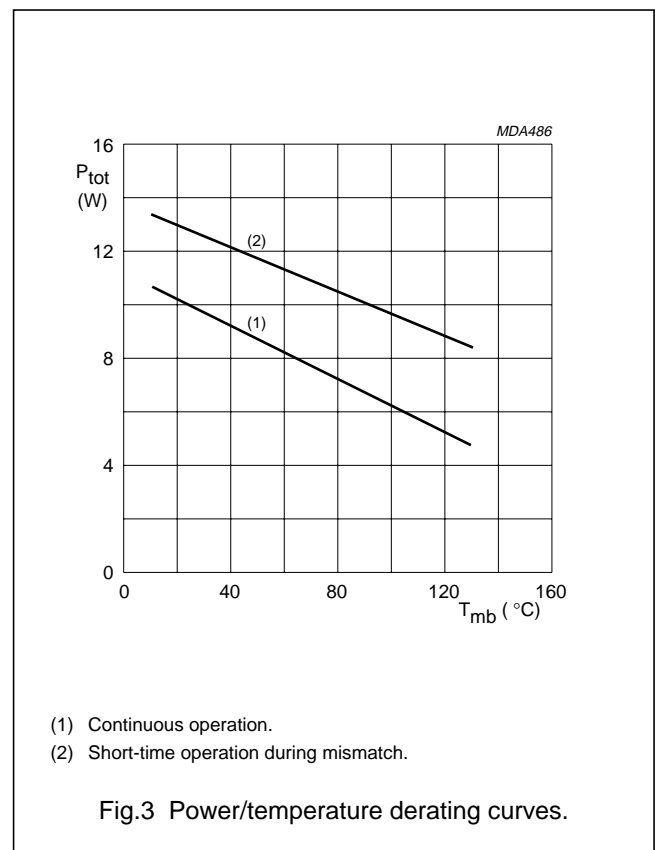
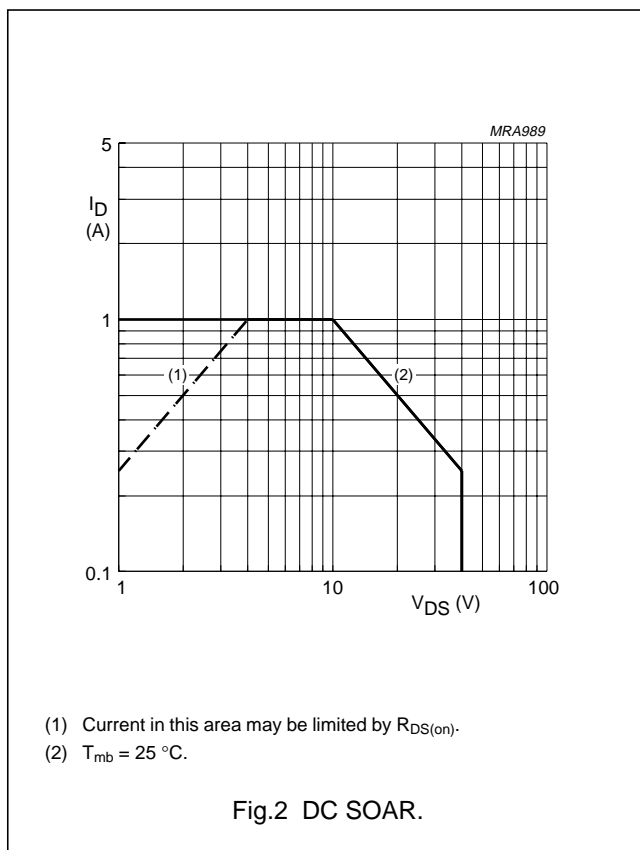

UHF power MOS transistor

BLF521

**CHARACTERISTICS**

$T_j = 25\text{ }^\circ\text{C}$  unless otherwise specified.

SYMBOL	PARAMETER	CONDITIONS	MIN.	TYP.	MAX.	UNIT
$V_{(BR)DSS}$	drain-source breakdown voltage	$V_{GS} = 0; I_D = 3\text{ mA}$	40	–	–	V
$I_{DSS}$	drain-source leakage current	$V_{GS} = 0; V_{DS} = 12.5\text{ V}$	–	–	10	$\mu\text{A}$
$I_{GSS}$	gate-source leakage current	$\pm V_{GS} = 20\text{ V}; V_{DS} = 0$	–	–	1	$\mu\text{A}$
$V_{GS(th)}$	gate-source threshold voltage	$I_D = 3\text{ mA}; V_{DS} = 10\text{ V}$	2	–	4.5	V
$g_{fs}$	forward transconductance	$I_D = 0.3\text{ A}; V_{DS} = 10\text{ V}$	80	135	–	mS
$R_{DS(on)}$	drain-source on-state resistance	$I_D = 0.3\text{ A}; V_{GS} = 15\text{ V}$	–	3.5	4	$\Omega$
$I_{DSX}$	on-state drain current	$V_{GS} = 15\text{ V}; V_{DS} = 10\text{ V}$	–	1.3	–	A
$C_{is}$	input capacitance	$V_{GS} = 0; V_{DS} = 12.5\text{ V}; f = 1\text{ MHz}$	–	5.3	–	pF
$C_{os}$	output capacitance	$V_{GS} = 0; V_{DS} = 12.5\text{ V}; f = 1\text{ MHz}$	–	7.8	–	pF
$C_{rs}$	feedback capacitance	$V_{GS} = 0; V_{DS} = 12.5\text{ V}; f = 1\text{ MHz}$	–	1.8	–	pF

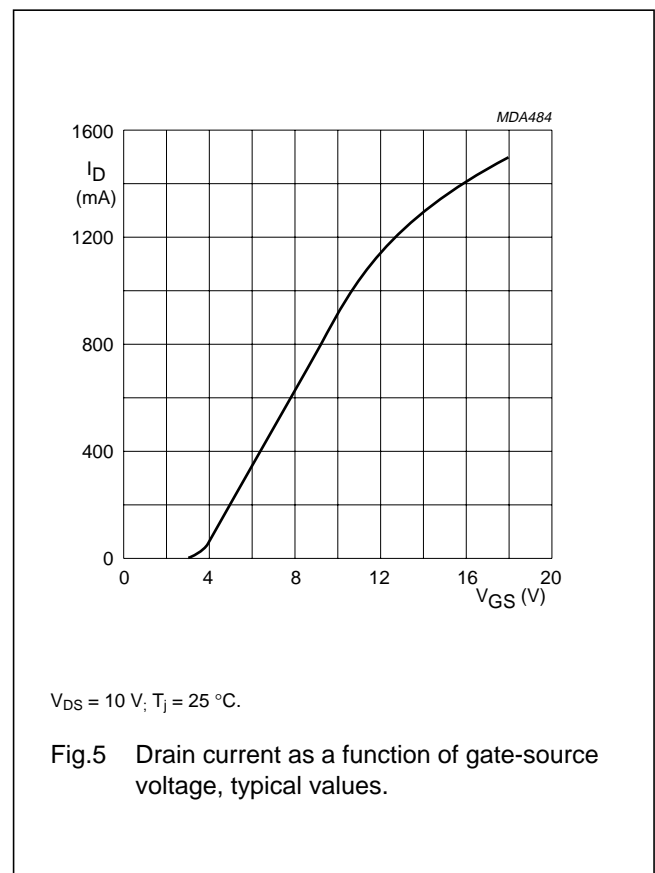
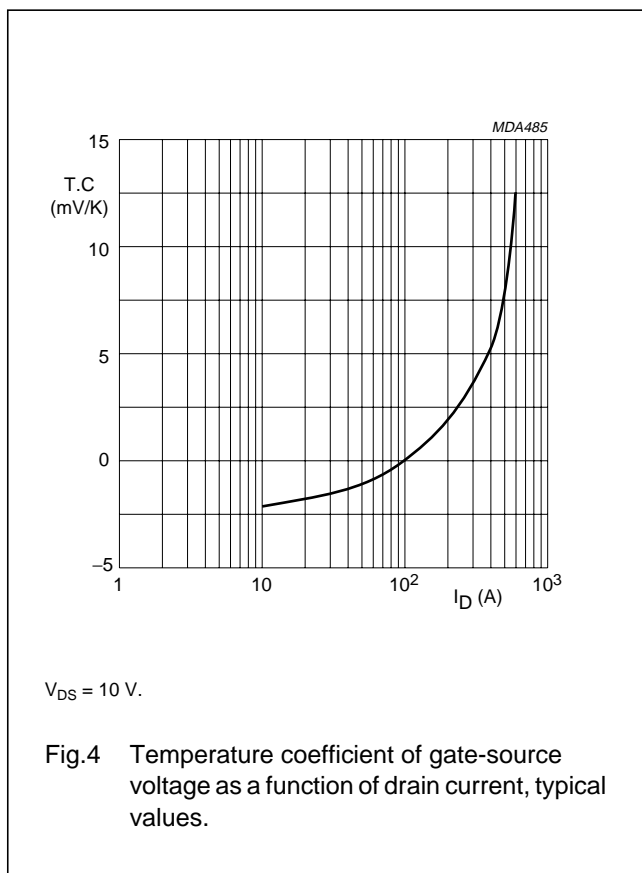

UHF power MOS transistor

BLF521

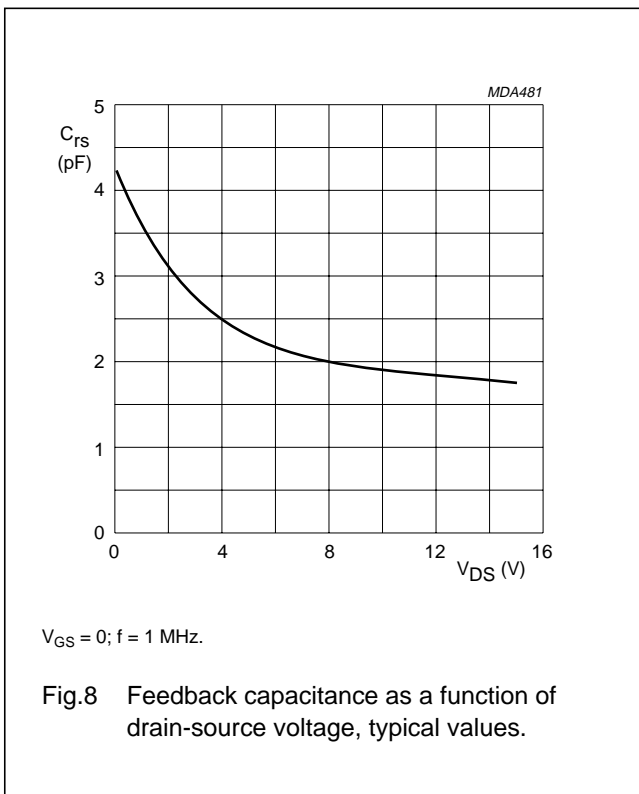
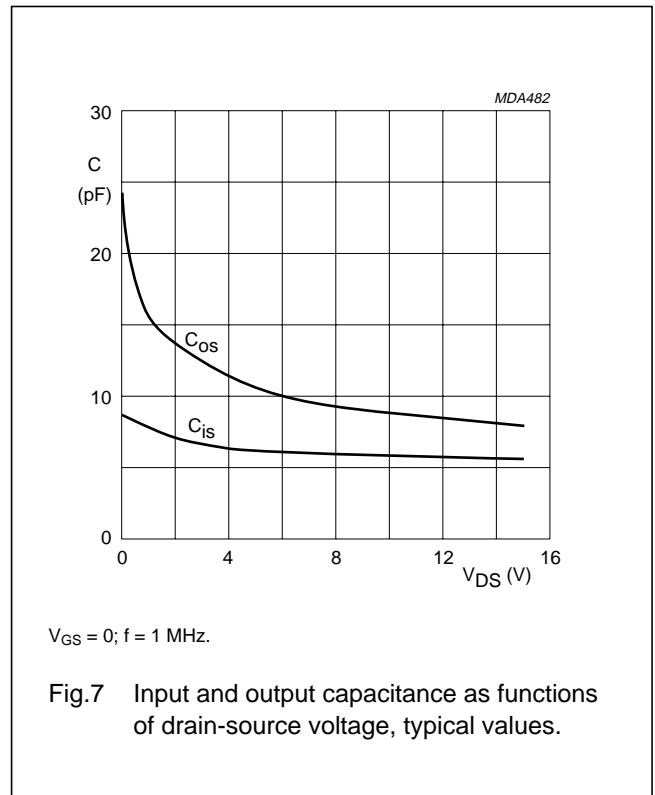
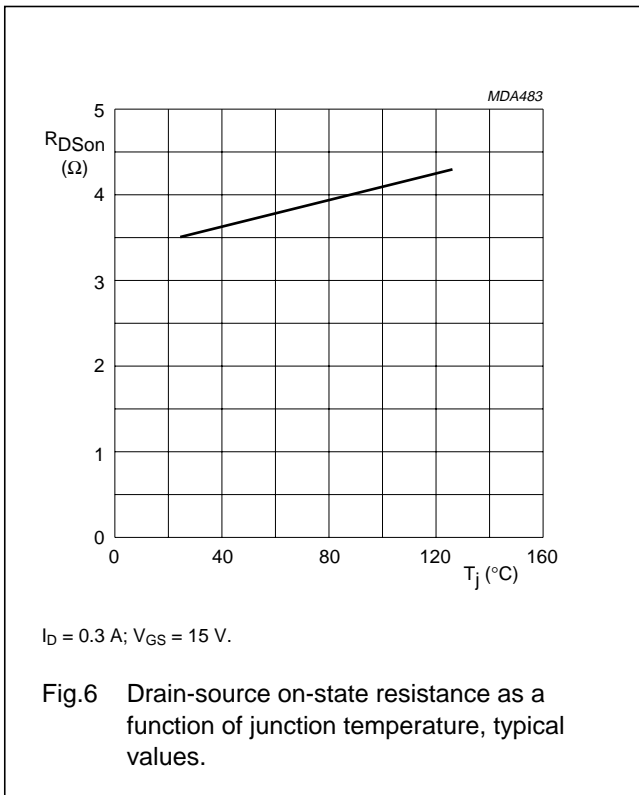

# UHF power MOS transistor

# BLF521

## APPLICATION INFORMATION FOR CLASS-B OPERATION

$T_{amb} = 25\text{ }^{\circ}\text{C}$ ;  $R_{GS} = 274\ \Omega$ , unless otherwise specified.

RF performance in a common source class-B test circuit.

MODE OF OPERATION	f (MHz)	V <sub>DS</sub> (V)	I <sub>DQ</sub> (mA)	P <sub>L</sub> (W)	G <sub>p</sub> (dB)	$\eta_D$ (%)
CW, class-B	500	12.5	10	2	> 10 typ. 13	> 50 typ. 60

### Ruggedness in class-B operation

The BLF521 is capable of withstanding a load mismatch corresponding to VSWR = 50:1 through all phases under the following conditions:

$V_{DS} = 15.5\text{ V}$ ;  $f = 500\text{ MHz}$  at rated output power.

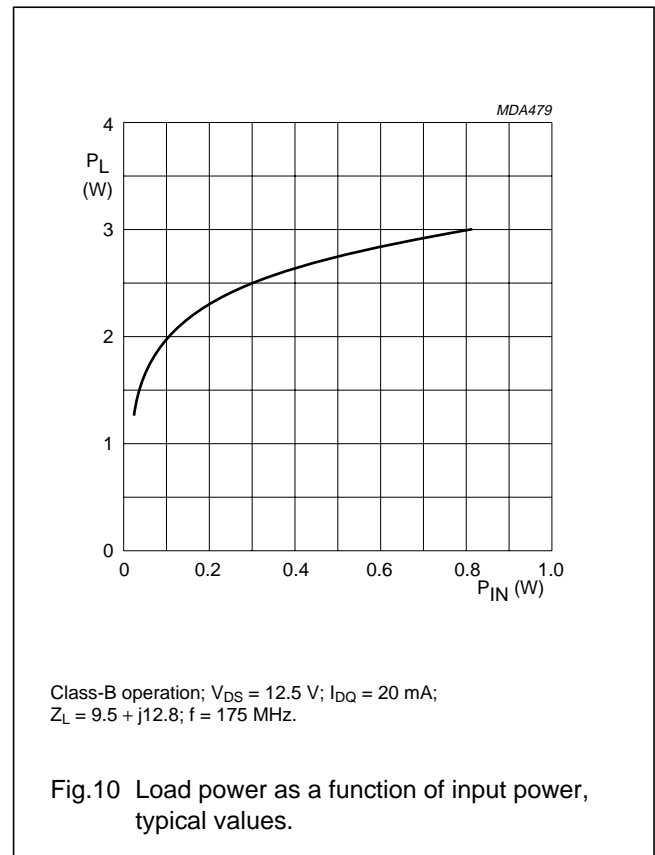
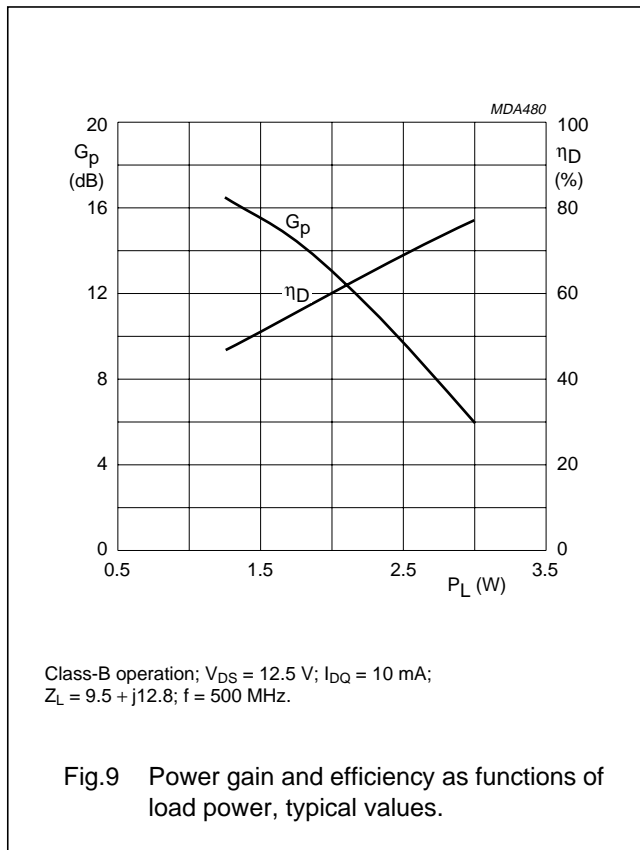

UHF power MOS transistor

BLF521

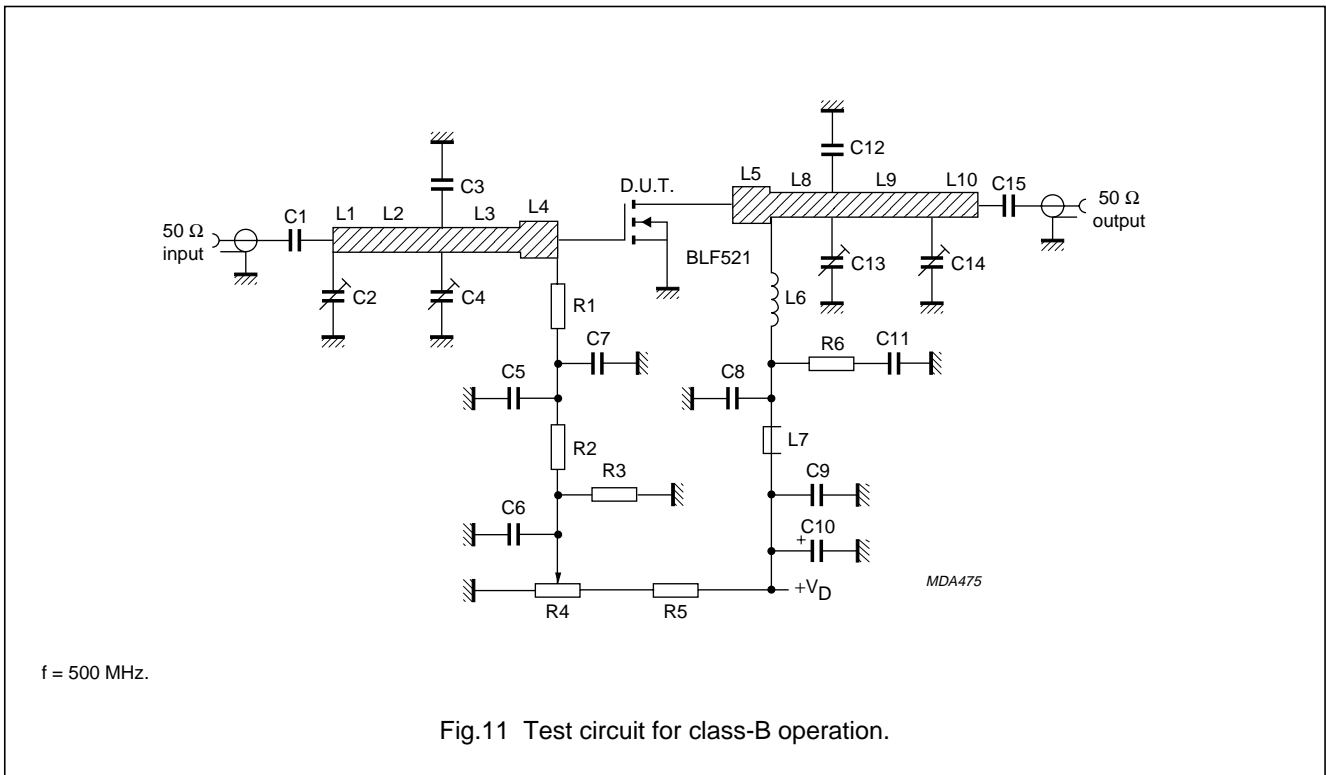

## UHF power MOS transistor

BLF521

## List of components (class-AB test circuit)

COMPONENT	DESCRIPTION	VALUE	DIMENSIONS	CATALOGUE NO.
C1, C5, C8, C15	multilayer ceramic chip capacitor (note 1)	390 pF, 500 V		
C2, C13	film dielectric trimmer	2 to 9 pF		2222 809 09002
C3	multilayer ceramic chip capacitor (note 2)	5.6 pF, 500 V		
C4	film dielectric trimmer	2 to 18 pF		2222 809 09003
C6, C11	multilayer ceramic chip capacitor	2 × 100 nF in parallel, 50 V		2222 852 47104
C7, C9	multilayer ceramic chip capacitor	100 nF, 50 V		2222 852 47104
C10	electrolytic capacitor	10 µF, 63 V		2222 030 38109
C12	multilayer ceramic chip capacitor (note 2)	9.1 pF, 50 V		
C14	film dielectric trimmer	1.4 to 5.5 pF		2222 809 09001
L1	stripline (note 3)	83 Ω	20 × 2 mm	
L2	stripline (note 3)	83 Ω	21 × 2 mm	
L3	stripline (note 3)	83 Ω	19 × 2 mm	
L4, L5	stripline (note 3)	67 Ω	12 × 3 mm	
L6	5 turns enamelled 0.5 mm copper wire	62 nH	length 3.75 mm int. dia. 3 mm leads 2 × 4 mm	
L7	grade 3B Ferroxcube RF choke			4312 020 36642
L8	stripline (note 3)	83 Ω	18.6 × 2 mm	
L9	stripline (note 3)	83 Ω	31.6 × 2 mm	
L10	stripline (note 3)	83 Ω	2 × 2 mm	
R1	0.4 W metal film resistor	274 Ω		2322 151 72741
R2	0.4 W metal film resistor	1.96 kΩ		2322 151 71962
R3	0.4 W metal film resistor	1 MΩ		2322 151 71005
R4	cermet potentiometer	5 kΩ		
R5	0.4 W metal film resistor	7.5 kΩ		2322 151 77502
R6	1 W metal film resistor	10 Ω		2322 153 51009

## Notes

1. American Technical Ceramics (ATC) capacitor, type 100B or other capacitor of the same quality.
2. American Technical Ceramics (ATC) capacitor, type 100A or other capacitor of the same quality.
3. The striplines are on a double copper-clad printed circuit board, with PTFE fibre-glass dielectric ( $\epsilon_r = 2.2$ ), thickness 1.6 mm.



UHF power MOS transistor

BLF521

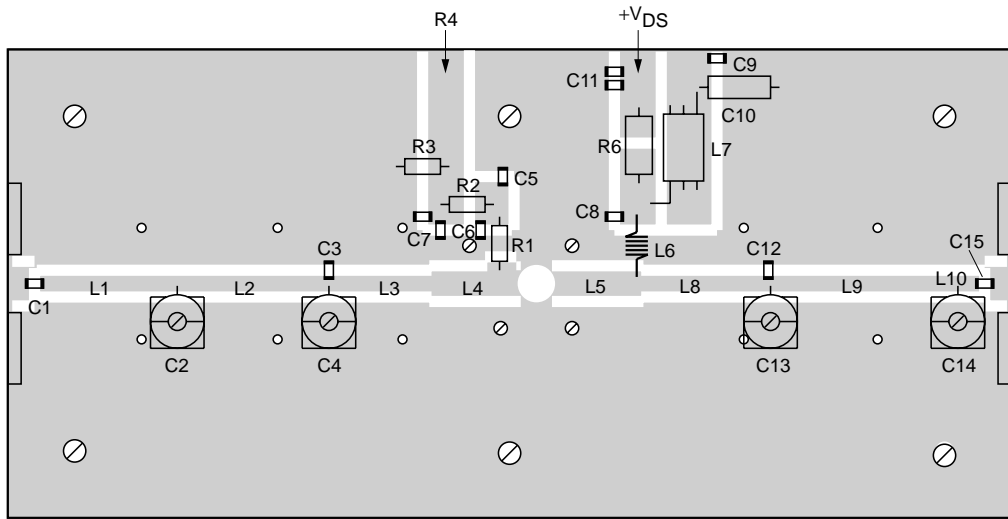

MBA381

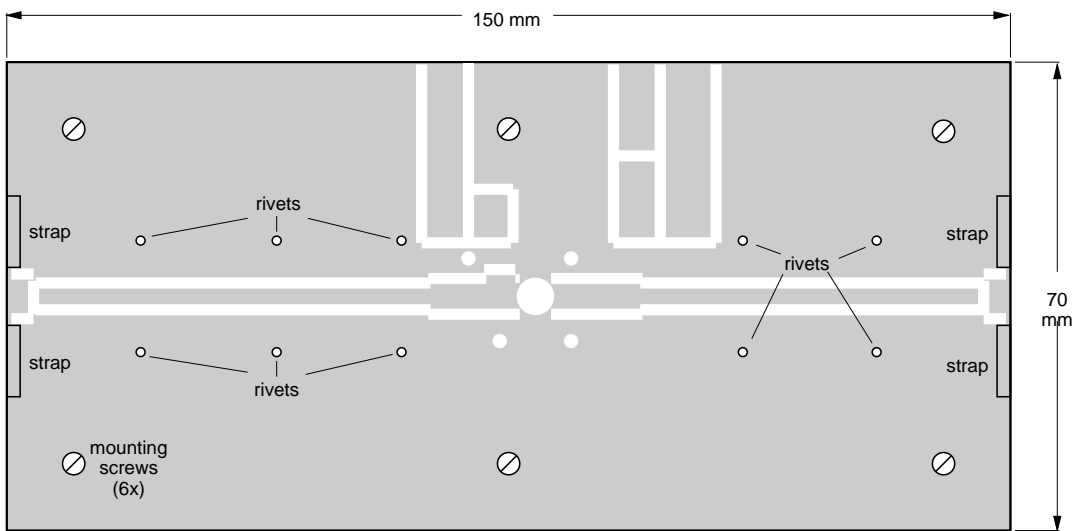

MBA380

The circuit and components are situated on one side of the printed circuit board, the other side being fully metallized, to serve as a ground plane. Earth connections are made by means of copper straps and hollow rivets for a direct contact between upper and lower sheets.

Fig.12 Component layout for 500 MHz test circuit.

UHF power MOS transistor

BLF521

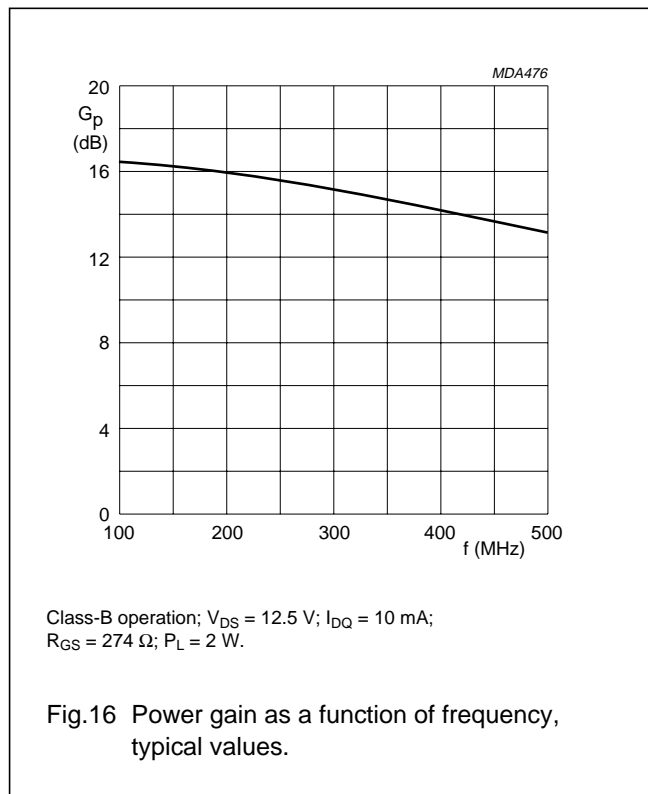
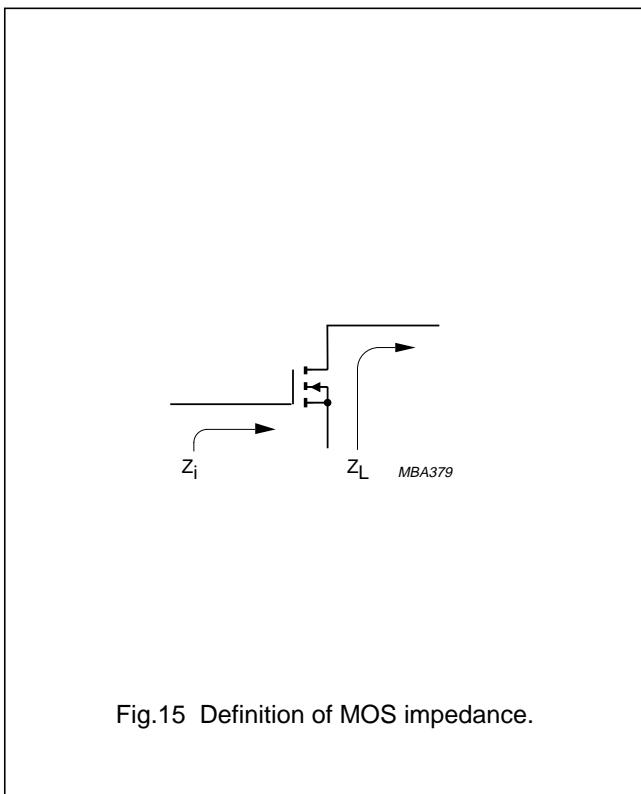
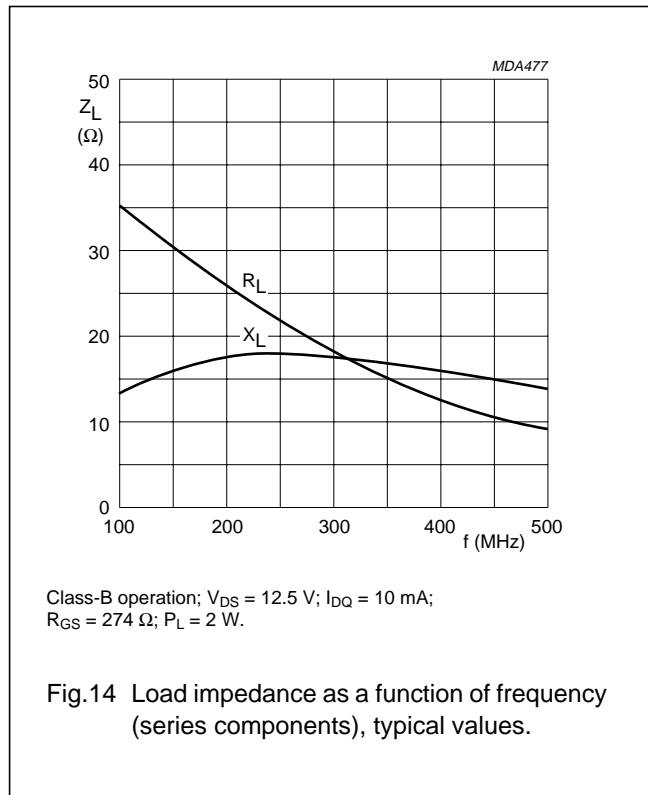
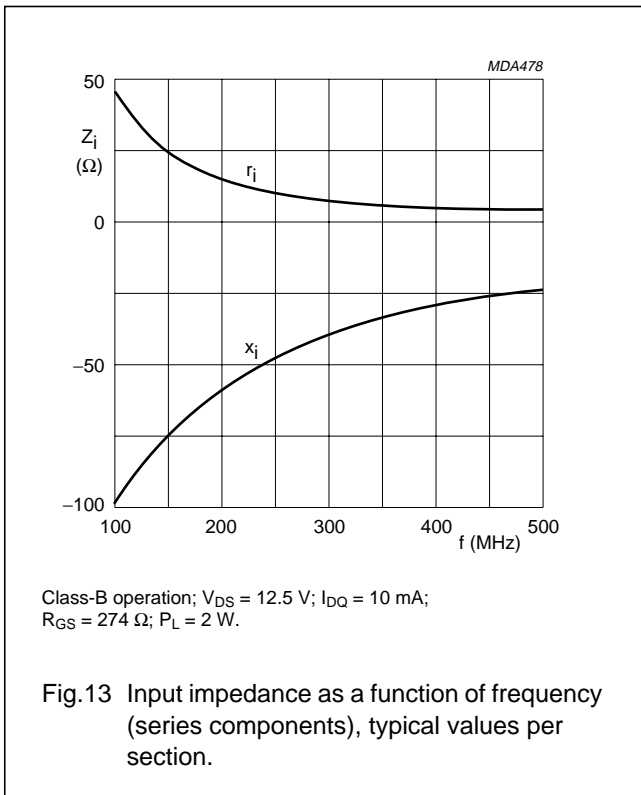

## UHF power MOS transistor

BLF521

## Common emitter S-parameters

Measured at  $V_{DS} = 12.5$  V and  $I_D = 100$  mA.

f (MHz)	S <sub>11</sub>		S <sub>21</sub>		S <sub>12</sub>		S <sub>22</sub>	
	MAGNITUDE (ratio)	ANGLE (deg)	MAGNITUDE (ratio)	ANGLE (deg)	MAGNITUDE (ratio)	ANGLE (deg)	MAGNITUDE (ratio)	ANGLE (deg)
40	0.968	-24.0	10.749	161.5	0.044	72.6	0.900	-27.4
100	0.864	-55.4	9.105	138.3	0.094	51.7	0.828	-62.4
200	0.701	-91.0	6.353	112.7	0.130	29.7	0.735	-100.8
300	0.626	-112.4	4.693	97.0	0.140	17.2	0.693	-122.7
400	0.587	-127.0	3.622	85.6	0.141	9.4	0.678	-136.3
500	0.580	-137.1	2.959	76.5	0.139	4.0	0.675	-145.4
600	0.580	-144.6	2.498	68.8	0.135	0.0	0.675	-152.1
700	0.581	-151.7	2.131	61.4	0.130	-2.5	0.677	-157.5
800	0.588	-157.6	1.874	54.7	0.123	-4.3	0.677	-162.3
900	0.596	-163.5	1.656	48.8	0.115	-4.8	0.683	-166.9
1000	0.605	-168.8	1.473	43.0	0.107	-4.4	0.689	-171.2

Measured at  $V_{DS} = 12.5$  V and  $I_D = 150$  mA.

f (MHz)	S <sub>11</sub>		S <sub>21</sub>		S <sub>12</sub>		S <sub>22</sub>	
	MAGNITUDE (ratio)	ANGLE (deg)	MAGNITUDE (ratio)	ANGLE (deg)	MAGNITUDE (ratio)	ANGLE (deg)	MAGNITUDE (ratio)	ANGLE (deg)
40	0.965	-25.9	11.435	160.6	0.044	72.0	0.876	-29.2
100	0.857	-58.7	9.534	136.8	0.092	50.1	0.804	-65.7
200	0.691	-95.1	6.529	111.3	0.125	28.6	0.715	-104.3
300	0.622	-116.7	4.783	96.0	0.134	16.7	0.678	-125.8
400	0.588	-130.3	3.663	84.8	0.135	9.2	0.666	-138.8
500	0.580	-140.8	2.988	75.9	0.133	4.3	0.665	-147.5
600	0.582	-147.8	2.515	68.4	0.128	0.7	0.666	-154.0
700	0.586	-154.9	2.154	61.2	0.123	-1.3	0.668	-159.1
800	0.588	-160.5	1.897	54.6	0.117	-2.6	0.669	-163.8
900	0.599	-166.3	1.673	48.8	0.111	-2.6	0.675	-168.1
1000	0.609	-171.7	1.493	43.0	0.103	-1.7	0.681	-172.3

## UHF power MOS transistor

BLF521

Measured at  $V_{DS} = 12.5$  V and  $I_D = 200$  mA.

f (MHz)	S <sub>11</sub>		S <sub>21</sub>		S <sub>12</sub>		S <sub>22</sub>	
	MAGNITUDE (ratio)	ANGLE (deg)	MAGNITUDE (ratio)	ANGLE (deg)	MAGNITUDE (ratio)	ANGLE (deg)	MAGNITUDE (ratio)	ANGLE (deg)
40	0.965	-26.7	11.660	160.1	0.044	71.4	0.854	-30.4
100	0.851	-60.7	9.625	135.9	0.091	49.4	0.783	-67.7
200	0.688	-97.5	6.524	110.5	0.123	27.9	0.699	-106.5
300	0.623	-118.8	4.751	95.2	0.131	16.4	0.666	-127.6
400	0.590	-132.7	3.644	84.3	0.132	9.2	0.657	-140.3
500	0.585	-142.4	2.968	75.3	0.130	4.3	0.658	-148.7
600	0.583	-150.0	2.495	67.8	0.126	1.0	0.659	-155.0
700	0.589	-156.7	2.137	60.7	0.120	-0.8	0.662	-160.0
800	0.593	-162.2	1.877	54.3	0.114	-1.9	0.664	-164.6
900	0.602	-167.8	1.656	48.4	0.108	-1.7	0.670	-168.9
1000	0.612	-173.0	1.476	42.8	0.100	-0.5	0.677	-173.0

Measured at  $V_{DS} = 12.5$  V and  $I_D = 250$  mA.

f (MHz)	S <sub>11</sub>		S <sub>21</sub>		S <sub>12</sub>		S <sub>22</sub>	
	MAGNITUDE (ratio)	ANGLE (deg)	MAGNITUDE (ratio)	ANGLE (deg)	MAGNITUDE (ratio)	ANGLE (deg)	MAGNITUDE (ratio)	ANGLE (deg)
40	0.963	-27.3	11.640	159.7	0.045	70.8	0.832	-31.3
100	0.848	-62.0	9.567	135.2	0.092	48.9	0.766	-69.2
200	0.686	-99.3	6.434	109.8	0.123	27.4	0.688	-108.2
300	0.624	-120.3	4.674	94.6	0.130	16.0	0.657	-128.9
400	0.594	-134.2	3.582	83.8	0.130	8.9	0.651	-141.3
500	0.585	-143.9	2.914	74.7	0.128	4.2	0.651	-149.6
600	0.590	-150.8	2.447	67.4	0.124	0.9	0.654	-155.8
700	0.595	-157.6	2.097	60.3	0.119	-0.6	0.658	-160.7
800	0.601	-163.1	1.840	53.8	0.113	-1.7	0.660	-165.2
900	0.607	-168.8	1.625	48.0	0.106	-1.3	0.667	-169.4
1000	0.613	-174.1	1.447	42.2	0.099	-0.1	0.673	-173.3

UHF power MOS transistor

BLF521

PACKAGE OUTLINE

Studless ceramic package; 4 leads

SOT172D

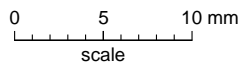
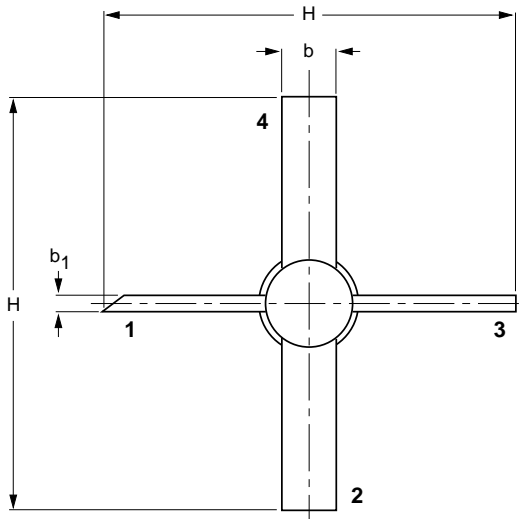
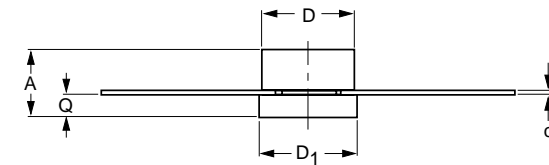

DIMENSIONS (millimetre dimensions are derived from the original inch dimensions)

UNIT	A	b	b <sub>1</sub>	c	D	D <sub>1</sub>	H	Q
mm	3.71 2.89	3.31 3.04	0.89 0.63	0.16 0.10	5.20 4.95	5.33 5.08	26.17 24.63	1.15 0.88
inches	0.146 0.114	0.13 0.12	0.035 0.025	0.006 0.004	0.205 0.195	0.210 0.200	1.03 0.97	0.045 0.035

OUTLINE VERSION	REFERENCES				EUROPEAN PROJECTION	ISSUE DATE
	IEC	JEDEC	EIAJ			
SOT172D						97-06-28

## UHF power MOS transistor

BLF521

**DEFINITIONS**

<b>Data Sheet Status</b>	
Objective specification	This data sheet contains target or goal specifications for product development.
Preliminary specification	This data sheet contains preliminary data; supplementary data may be published later.
Product specification	This data sheet contains final product specifications.
<b>Limiting values</b>	
Limiting values given are in accordance with the Absolute Maximum Rating System (IEC 134). Stress above one or more of the limiting values may cause permanent damage to the device. These are stress ratings only and operation of the device at these or at any other conditions above those given in the Characteristics sections of the specification is not implied. Exposure to limiting values for extended periods may affect device reliability.	
<b>Application information</b>	
Where application information is given, it is advisory and does not form part of the specification.	

**LIFE SUPPORT APPLICATIONS**

These products are not designed for use in life support appliances, devices, or systems where malfunction of these products can reasonably be expected to result in personal injury. Philips customers using or selling these products for use in such applications do so at their own risk and agree to fully indemnify Philips for any damages resulting from such improper use or sale.