



IMB08-04NPSVT0S

IMB

INDUCTIVE PROXIMITY SENSORS

SICK
Sensor Intelligence.



Illustration may differ



Ordering information

Type	Part no.
IMB08-04NPSVT0S	1072592

Other models and accessories → www.sick.com/IMB

Detailed technical data

Features

Housing	Cylindrical thread design
Housing	Standard
Thread size	M8 1
Diameter	Ø 8 mm
Sensing range S_n	4 mm
Safe sensing range S_a	3.24 mm
Installation type	Non-flush
Switching frequency	4,000 Hz
Connection type	Connector M8, 3-pin ¹⁾
Switching output	PNP
Output function	NO
Electrical wiring	DC 3-wire
Enclosure rating	IP68 ²⁾ IP69K ³⁾
Special features	Resistant against coolant lubricants, Optical adjustment indicator Capable of communication via IO-Link 1.0

¹⁾ With gold plated contact pins.

²⁾ According to EN 60529.

³⁾ According to ISO 20653:2013-03.

Communication interface

Communication interface	IO-Link V1.0
Mode	COM2 (38,4 kBaud)
Process data length	1 Byte
Process data structure	Bit 0 = Sr reached

Bit 1 = Sa reached

Mechanics/electronics

Supply voltage	10 V DC ... 30 V DC
Ripple	≤ 10 %
Voltage drop	≤ 2 V ¹⁾
Current consumption	≤ 10 mA ²⁾
Hysteresis	3 % ... 20 %
Reproducibility	≤ 2 % ^{3) 4)}
Temperature drift (of S_r)	± 10 %
EMC	According to EN 60947-5-2
Continuous current I_a	≤ 200 mA
Short-circuit protection	✓
Reverse polarity protection	✓
Power-up pulse protection	✓
Shock and vibration resistance	100 g / 11 ms / 1000 cycles; 150 g / 1 Mio cycles; 10 Hz ... 55 Hz, 1 mm / 55 z ... 500 Hz / 15 g
Ambient operating temperature	-40 °C ... +100 °C
Housing material	Stainless steel, V2A (1.4305)
Sensing face material	Plastic, LCP
Housing length	50 mm
Thread length	34 mm
Tightening torque, max.	Typ. 14 Nm ⁵⁾
UL File No.	E181493

¹⁾ At I_a max.

²⁾ Without load.

³⁾ U_b and T_a constant.

⁴⁾ Of S_r.

⁵⁾ Valid if toothed side of nut is used.

Reduction factors

Note	The values are reference values which may vary
Stainless steel (V2A, 304)	Approx. 0.69
Aluminum (Al)	Approx. 0.37
Copper (Cu)	Approx. 0.28
Brass (Br)	Approx. 0.4

Installation note

Remark	Associated graphic see "Installation"
A	8 mm
B	18 mm
C	8 mm
D	12 mm
E	8 mm
F	32 mm

Classifications

ECl@ss 5.0	27270101
ECl@ss 5.1.4	27270101
ECl@ss 6.0	27270101
ECl@ss 6.2	27270101
ECl@ss 7.0	27270101
ECl@ss 8.0	27270101
ECl@ss 8.1	27270101
ECl@ss 9.0	27270101
ETIM 5.0	EC002714
ETIM 6.0	EC002714
UNSPSC 16.0901	39122230

Installation note

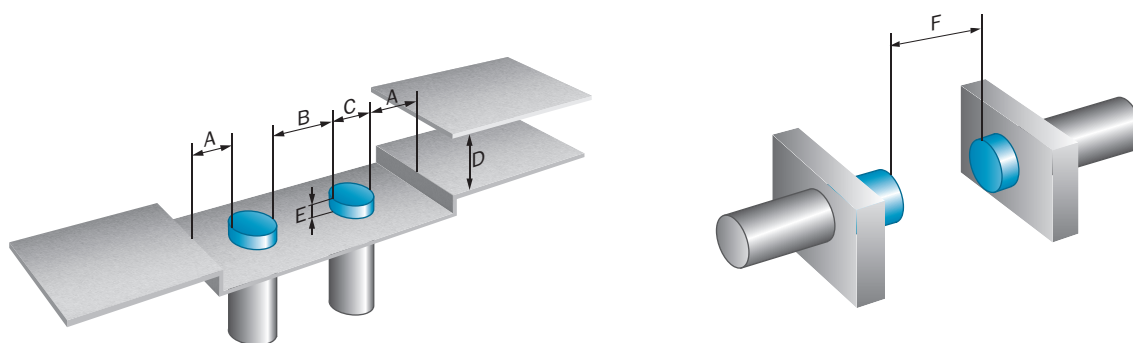

Adjustments possible

Normally open

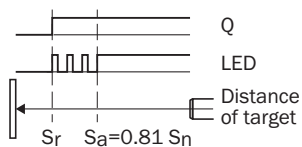

Connection diagram

cd-002

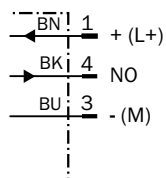

Characteristic curve

Non-flush installation

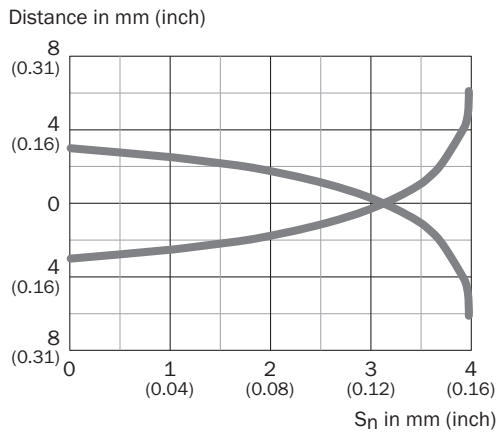

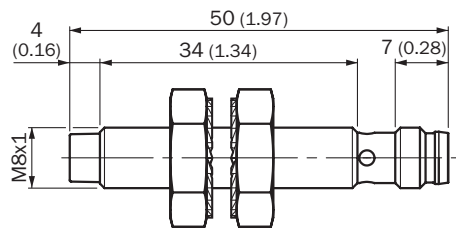

Dimensional drawing (Dimensions in mm (inch))

IMB08 Standard, connector M8, non-flush



Recommended accessories

Other models and accessories → www.sick.com/IMB

	Brief description	Type	Part no.
Universal bar clamp systems			
	Plate N11N for universal clamp bracket, Stainless steel 1.4571 (sheet), Stainless steel 1.4408 (clamp), Universal clamp (5322626), mounting hardware	BEF-KHS-N11N	2071081
Mounting brackets and plates			
	Mounting plate for M8 sensors, steel, zinc coated, without mounting hardware	BEF-WG-M08	5321722
	Mounting bracket for M8 sensors, steel, zinc coated, without mounting hardware	BEF-WN-M08	5321721

	Brief description	Type	Part no.
Plug connectors and cables			
	<p>Head A: female connector, M8, 3-pin, straight Head B: Flying leads Cable: PP, unshielded, 2 m This product is generally resistant to chemical cleaning agents (see ECOLAB) and other chemical compounds such as H2O2 and CH2O2. Before permanent installation is carried out, the material's resistance to the cleaning agent being used must be checked., Resistant against lactic acid & hydrogen peroxide (H2O2)</p>	DOL-0803-G02MRN	6058504
	<p>Head A: female connector, M8, 3-pin, straight Head B: Flying leads Cable: PP, unshielded, 5 m This product is generally resistant to chemical cleaning agents (see ECOLAB) and other chemical compounds such as H2O2 and CH2O2. Before permanent installation is carried out, the material's resistance to the cleaning agent being used must be checked., Resistant against lactic acid & hydrogen peroxide (H2O2)</p>	DOL-0803-G05MRN	6058505
	<p>Head A: female connector, M8, 3-pin, angled with LED Head B: Flying leads Cable: PP, unshielded, 2 m This product is generally resistant to chemical cleaning agents (see ECOLAB) and other chemical compounds such as H2O2 and CH2O2. Before permanent installation is carried out, the material's resistance to the cleaning agent being used must be checked., Resistant against lactic acid & hydrogen peroxide (H2O2)</p>	DOL-0803-L02MRN	6058787
	<p>Head A: female connector, M8, 3-pin, angled Head B: Flying leads Cable: PP, unshielded, 5 m This product is generally resistant to chemical cleaning agents (see ECOLAB) and other chemical compounds such as H2O2 and CH2O2. Before permanent installation is carried out, the material's resistance to the cleaning agent being used must be checked.</p>	DOL-0803-L05MRN	6058788
	<p>Head A: female connector, M8, 3-pin, angled Head B: Flying leads Cable: PP, unshielded, 2 m This product is generally resistant to chemical cleaning agents (see ECOLAB) and other chemical compounds such as H2O2 and CH2O2. Before permanent installation is carried out, the material's resistance to the cleaning agent being used must be checked., Resistant against lactic acid & hydrogen peroxide (H2O2)</p>	DOL-0803-W02MRN	6058507
	<p>Head A: female connector, M8, 3-pin, angled Head B: Flying leads Cable: PP, unshielded, 5 m This product is generally resistant to chemical cleaning agents (see ECOLAB) and other chemical compounds such as H2O2 and CH2O2. Before permanent installation is carried out, the material's resistance to the cleaning agent being used must be checked.</p>	DOL-0803-W05MRN	6058508
	<p>Head A: female connector, M8, 3-pin, straight, A-coded Head B: Flying leads Cable: Sensor/actuator cable, PUR, halogen-free, unshielded, 2 m</p>	YF8U13-020UA1XLEAX	2094782
	<p>Head A: female connector, M8, 3-pin, straight, A-coded Head B: Flying leads Cable: Sensor/actuator cable, PUR, halogen-free, unshielded, 5 m</p>	YF8U13-050UA1XLEAX	2094788
	<p>Head A: female connector, M8, 3-pin, angled, A-coded Head B: Flying leads Cable: Sensor/actuator cable, PUR, halogen-free, unshielded, 2 m</p>	YG8U13-020UA1XLEAX	2094794
	<p>Head A: female connector, M8, 3-pin, angled, A-coded Head B: Flying leads Cable: Sensor/actuator cable, PUR, halogen-free, unshielded, 5 m</p>	YG8U13-050UA1XLEAX	2095586
	<p>Head A: female connector, M8, 3-pin, angled with LED, A-coded Head B: Flying leads Cable: Sensor/actuator cable, PUR, halogen-free, unshielded, 2 m</p>	YI8U13-020UA1XLEAX	2095593
	<p>Head A: female connector, M8, 3-pin, straight, A-coded Head B: male connector, M8, 3-pin, straight, A-coded Cable: Sensor/actuator cable, PUR, halogen-free, unshielded, 2 m</p>	YF8U13-020UA1M8U13	2096304

	Brief description	Type	Part no.
	Head A: female connector, M8, 3-pin, straight, A-coded Head B: male connector, M8, 3-pin, straight, A-coded Cable: Sensor/actuator cable, PUR, halogen-free, unshielded, 5 m	YF8U13-050UA1M8U13	2096308

SICK AT A GLANCE

SICK is one of the leading manufacturers of intelligent sensors and sensor solutions for industrial applications. A unique range of products and services creates the perfect basis for controlling processes securely and efficiently, protecting individuals from accidents and preventing damage to the environment.

We have extensive experience in a wide range of industries and understand their processes and requirements. With intelligent sensors, we can deliver exactly what our customers need. In application centers in Europe, Asia and North America, system solutions are tested and optimized in accordance with customer specifications. All this makes us a reliable supplier and development partner.

Comprehensive services complete our offering: SICK LifeTime Services provide support throughout the machine life cycle and ensure safety and productivity.

For us, that is “Sensor Intelligence.”

WORLDWIDE PRESENCE:

Contacts and other locations –www.sick.com