



Underside View
(this side faces the passenger)



Top View
(this side faces the sky)

Stingray

MA206.A.AB.004

Specification

Part No.	MA206.A.AB.004
Product Name	Stingray MA.206 Stingray GPS/2.4~2.54GHz Combination Adhesive Antenna
Feature	GPS - High gain LNA up to 32dB 2.4~2.5GHz Height 10.8mm Diameter 55.1mm GPS - Standard 3m RG174 cable and SMA(M) connector 2.4GHZ - Standard 3m RG174 cable and RF-SMA(M) RoHS Compliant

1. Introduction

This is a combination high performance GPS and 2.4~2.5GHz antenna to simplify AVL or Fleet management antenna systems worldwide. Its high quality low profile covert housing can be attached onto the glass or even out of sight under the dashboard. This combination is ideal for those applications that require durability, small size, and covert installation.

The standard version has 3 metres RG174 cable and SMA(M) connector on GPS and RP-SMA(M) on 2.4~2.5GHz. The cables and connectors are completely customizable according to customer request.

Features

GPS

- High LNA Gain up to 32 dB
- Miniaturized to 51.7x10.8mm
- Low Noise 1.5 dB max

Wi-Fi

- Advanced 2.4~2.5GHz

Other

- Water Resistant IP 65
- Quality textured covert design. Low profile
- UV resistant ABS housing
- Comes with high grade 3M double sided tape for quick and easy mounting
- Customizable cables and connectors

2. Specification

PERFORMANCE SPECIFICATIONS		
Items	GPS Antenna	2.4~2.5GHz
Features	High performance GPS ceramic patch antenna with cutting edge low noise amplifier	2400MHz to 2500MHz
Frequency	1575.42 MHz \pm 2MHz	2.4 - 2.5 GHz
Gain	28dB typ. Gain at Zenith: -1.0 dBi min Axial Ratio :3.0 dB max	0 dB typ.
Noise Figure	2dB max.	-
Polarization	RHCP	Linear
DC Power Input	2.7 ~ 3.3V	-
Bandwidth	10 MHz min	100 MHz
VSWR	\leq 1.92	\leq 1.92
Impedance	50 Ω	50 Ω
Cable / Connector	Standard 3m RG-174 Cable / SMA(M) Connector	Standard 3m RG-174 Cable / RP-SMA(M) Connector
Operating Temperature	-40°C ~ +85°C	-40°C ~ +85°C
Storage Temperature	-40°C ~ +95°C	-40°C ~ +95°C
Size	51.7mm * 10.8mm	
Housing	UV resistant ABS	

***Note:** Specifications may be subject to change

3. Electrical Characteristic – 2.4~2.5GHz

3.1 Test Setup

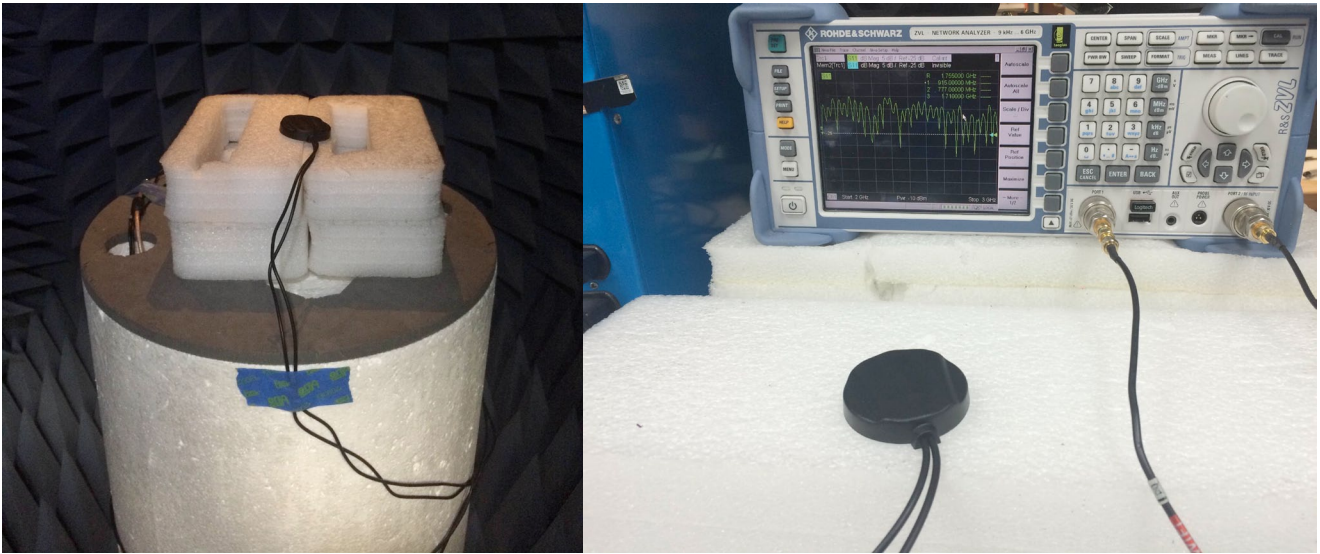

3.2 Return Loss (2.4~2.5GHz Antenna)

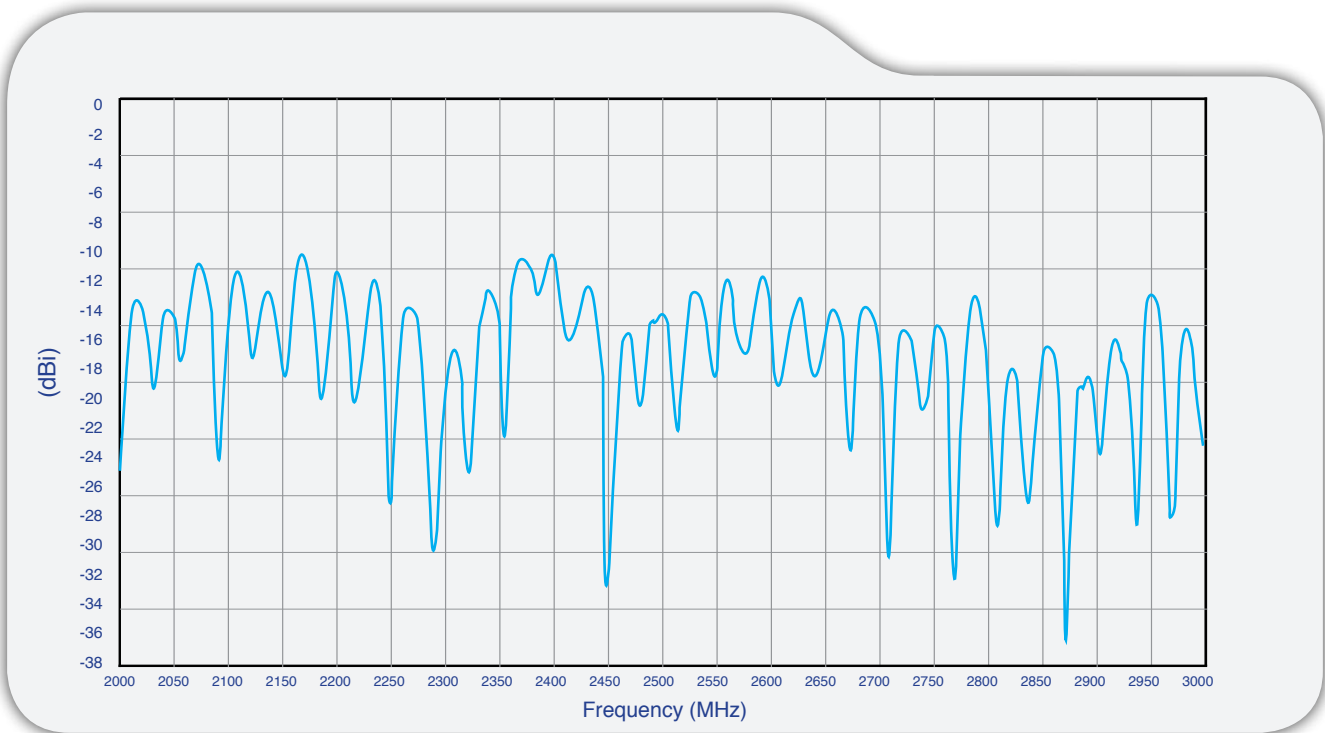

3.3 Efficiency (2.4~2.5GHz Antenna)

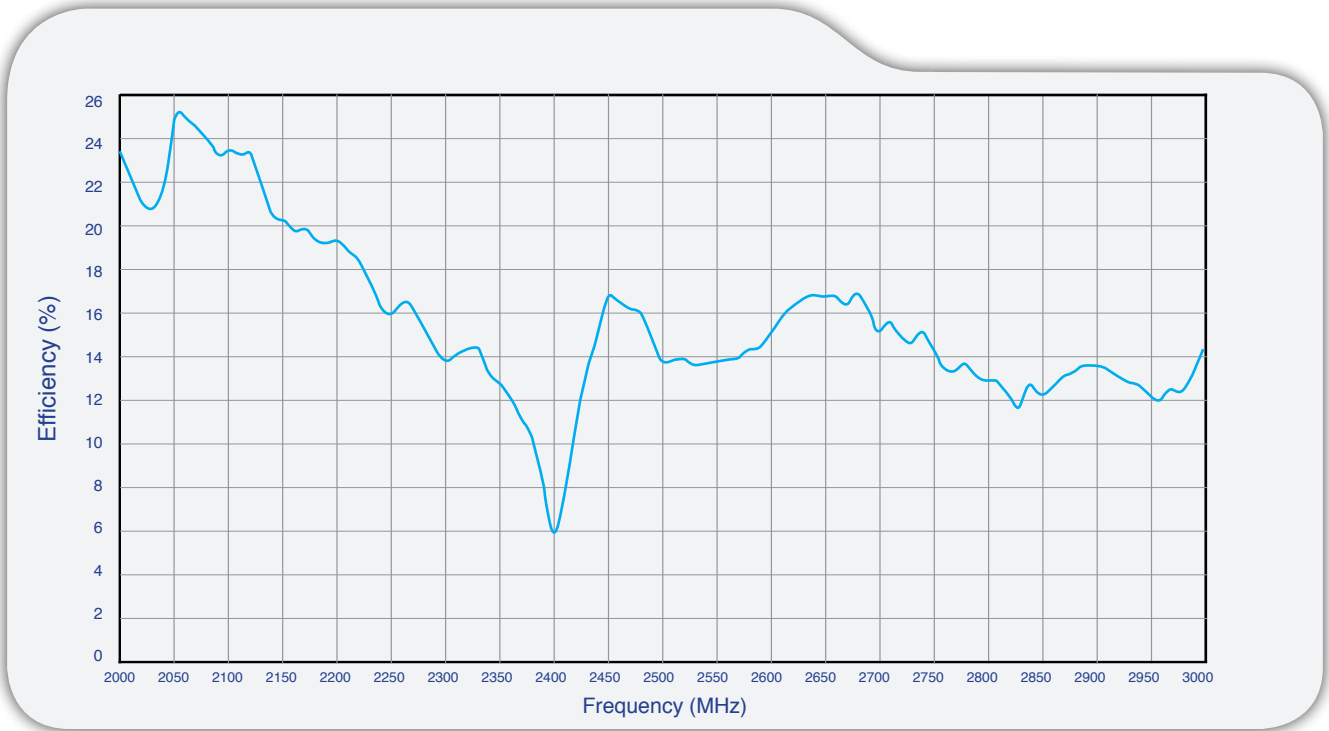

3.4 Peak Gain (2.4~2.5GHz Antenna)

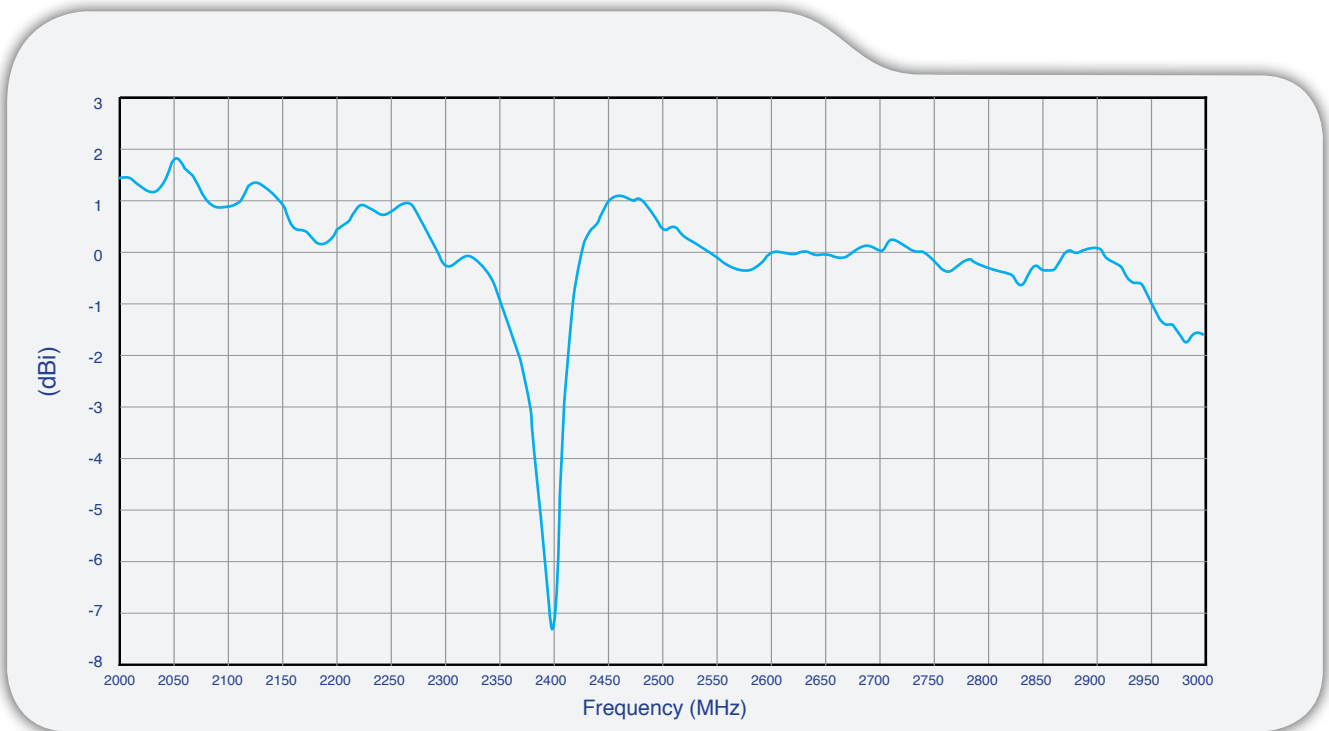

3.2 Radiation Patterns WiFi Antenna

XZ Plane

YZ Plane

2400 MHz

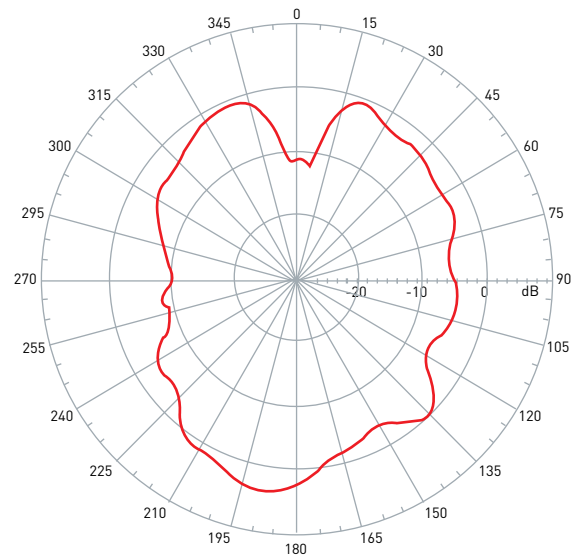
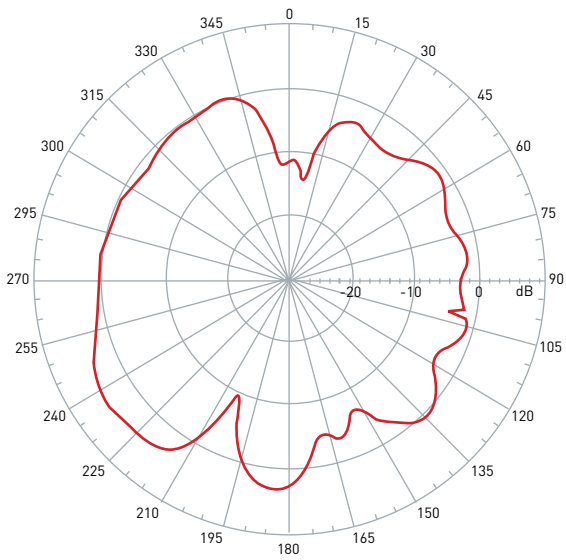

2412 MHz

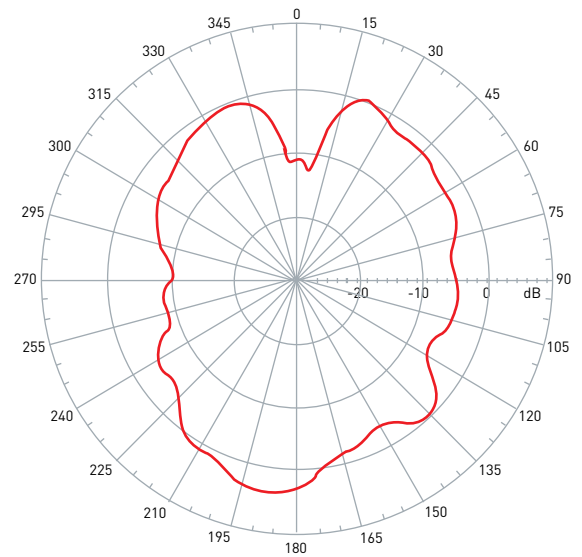
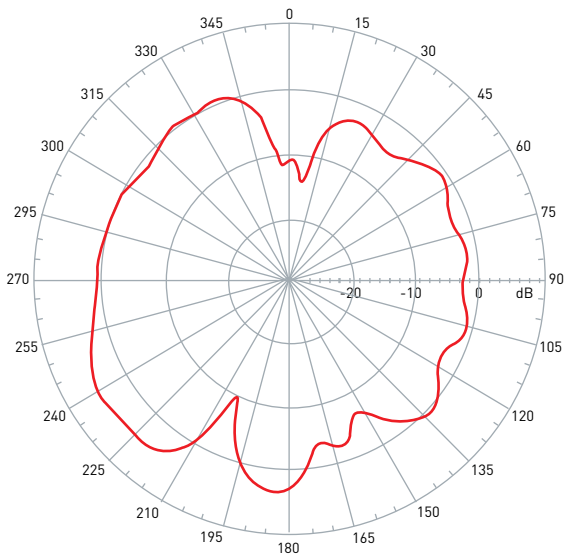

3.2 Radiation Patterns WiFi Antenna

XZ Plane

YZ Plane

2437 MHz

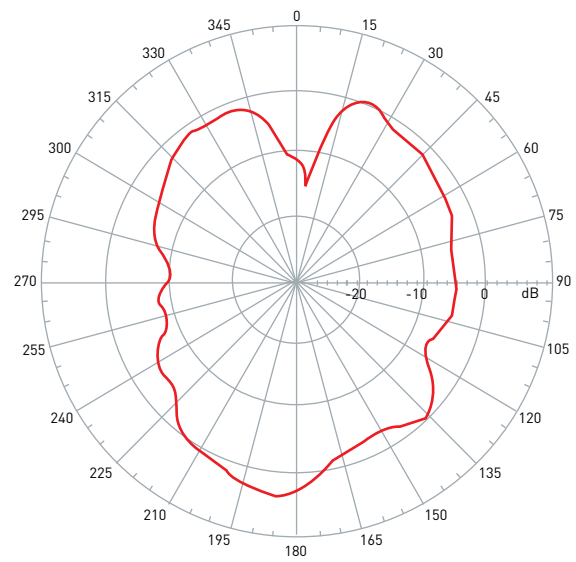
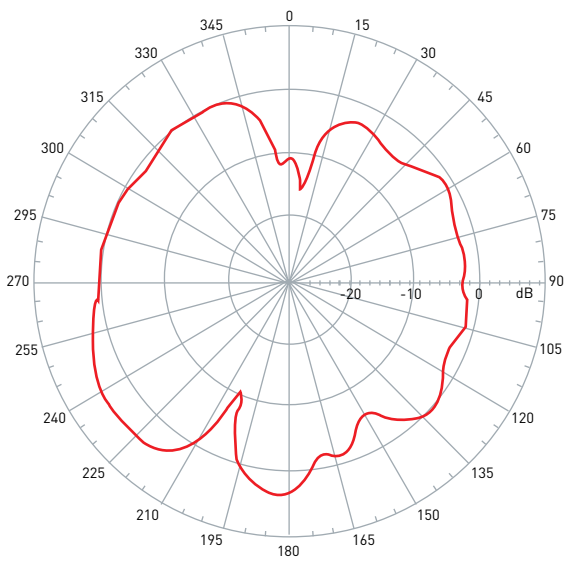

2450 MHz

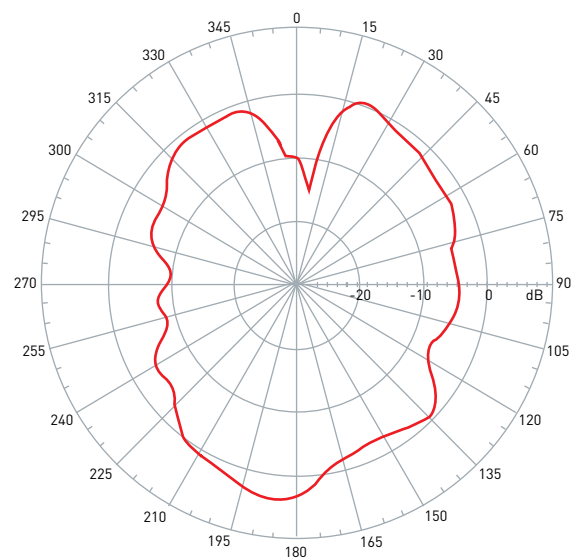
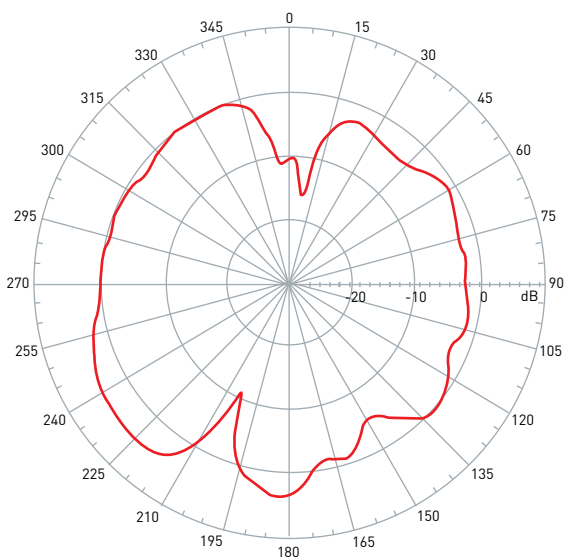

3.2 Radiation Patterns WiFi Antenna

XZ Plane

YZ Plane

2472 MHz

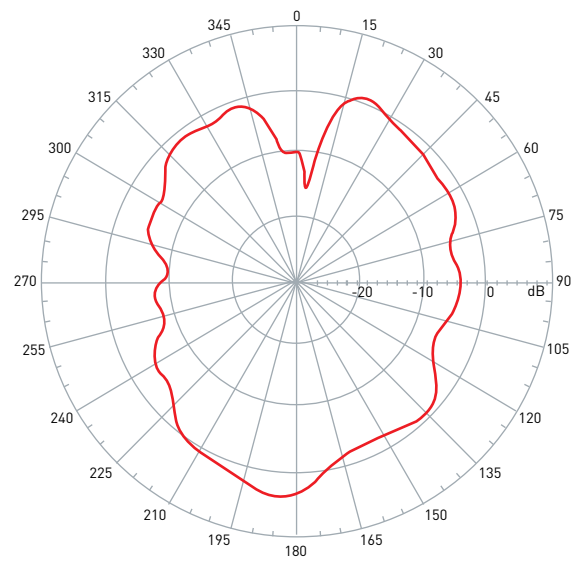
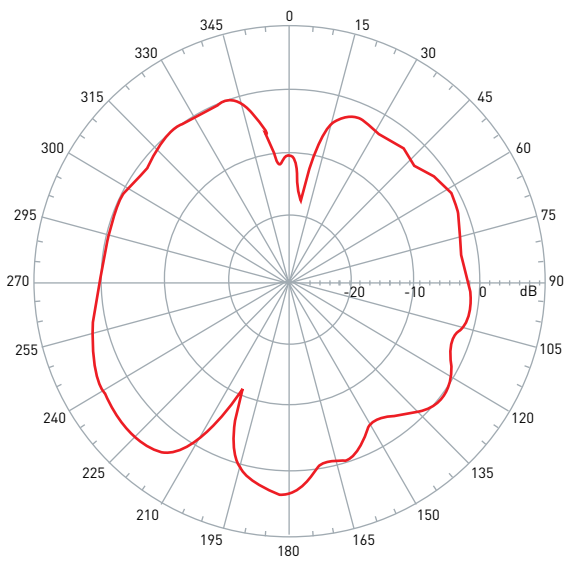

2500 MHz

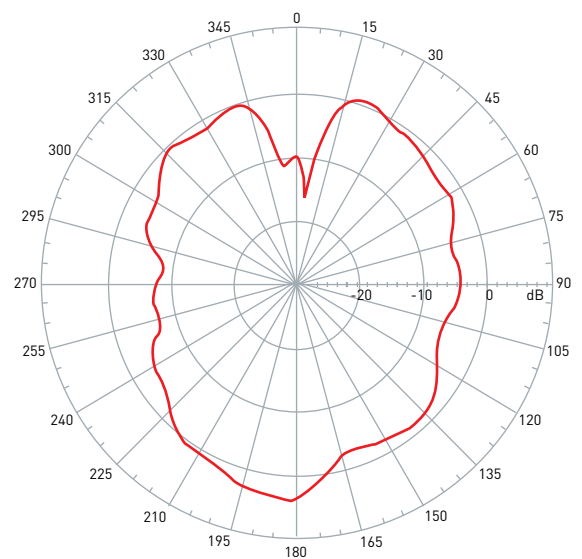
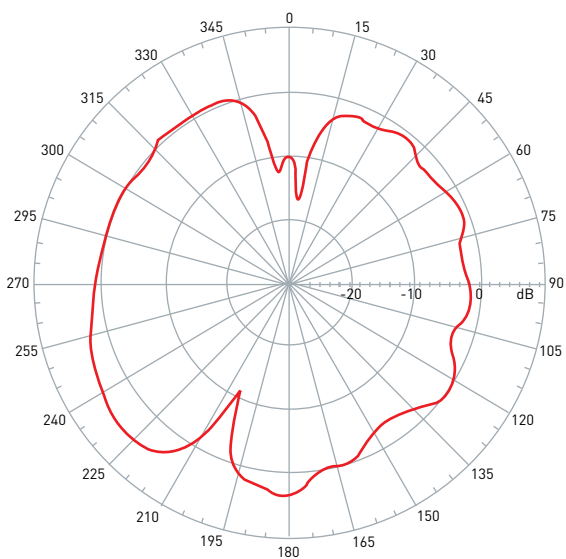

4. Electrical Characteristic - GPS

4.1 Return Loss

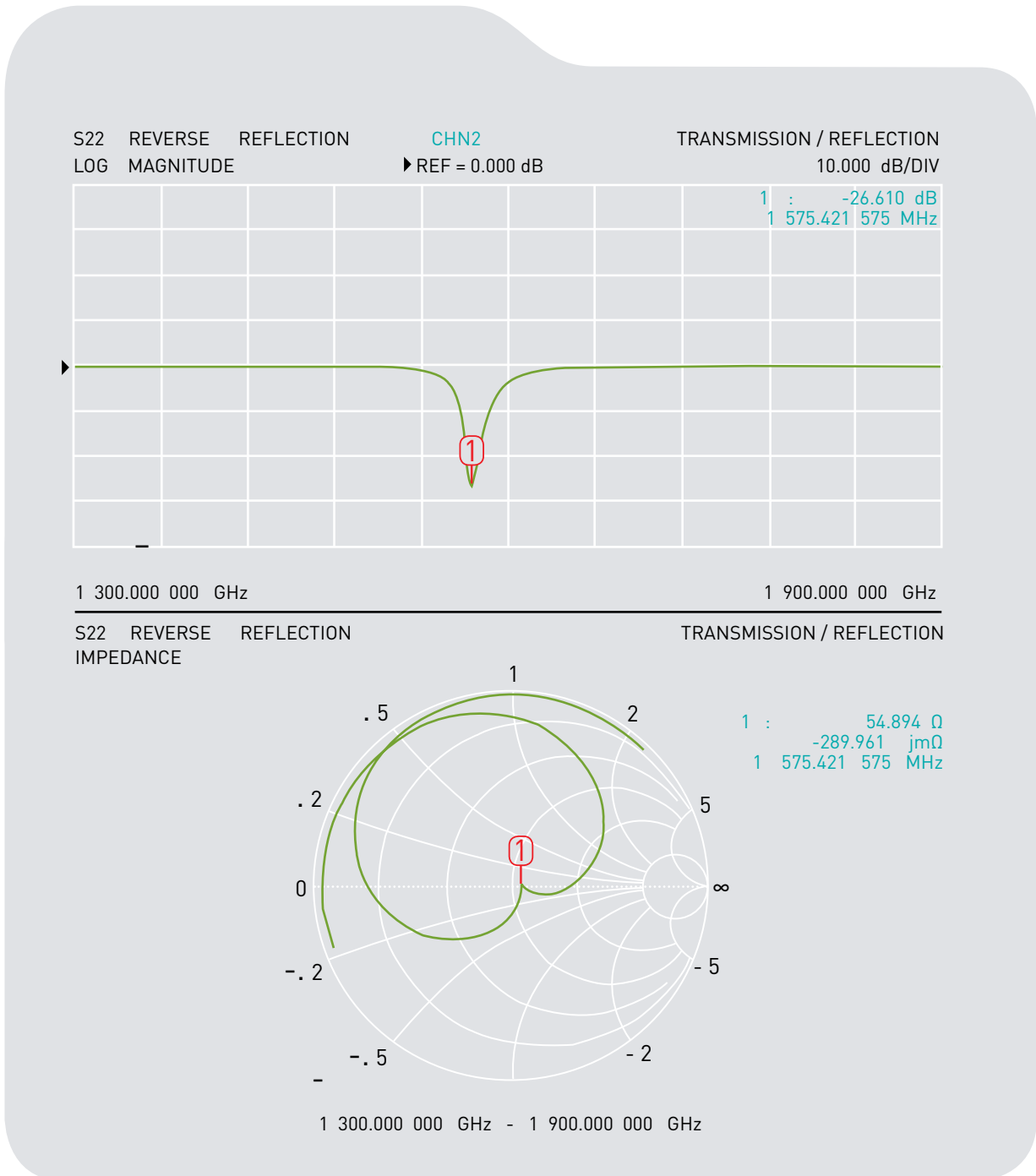

4.2 Radiation Patterns

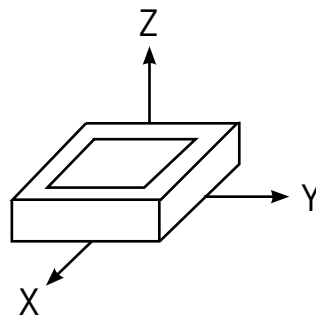

XZ Plane

YZ Plane

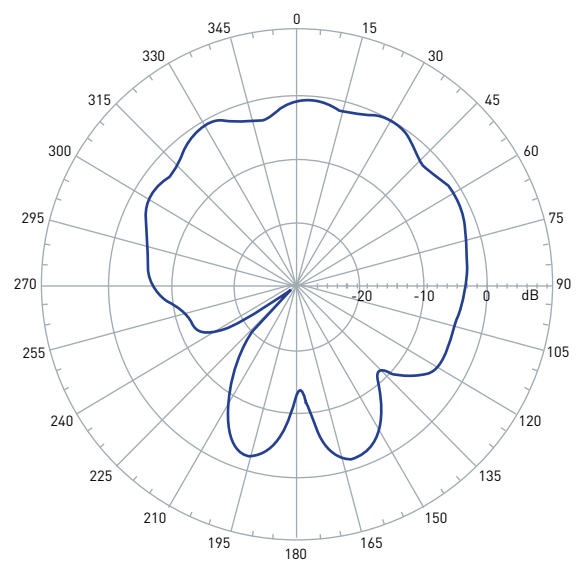
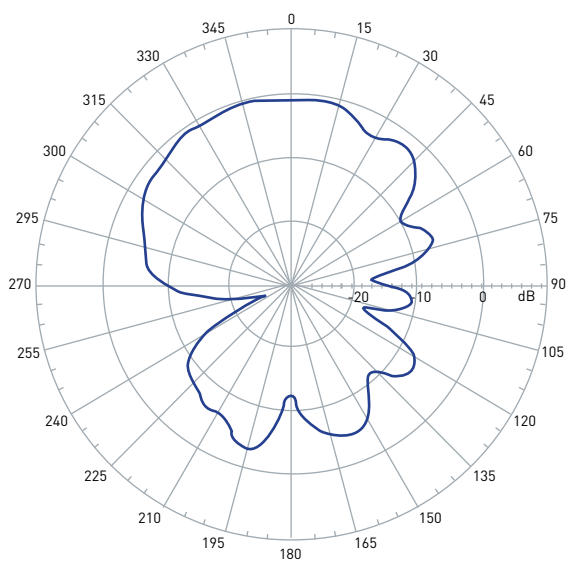

4.3 LNA S22

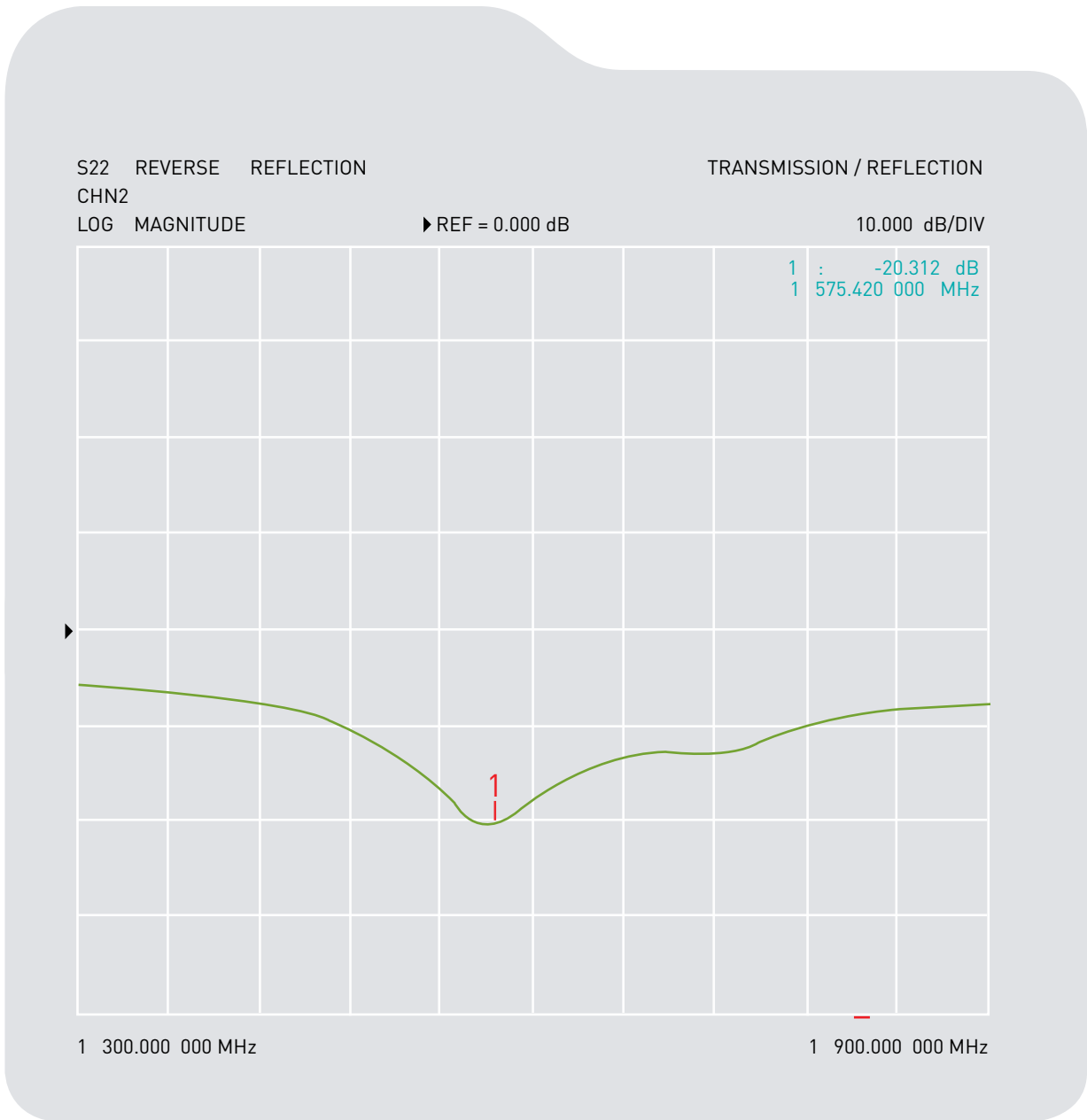

4.3 LNA S21

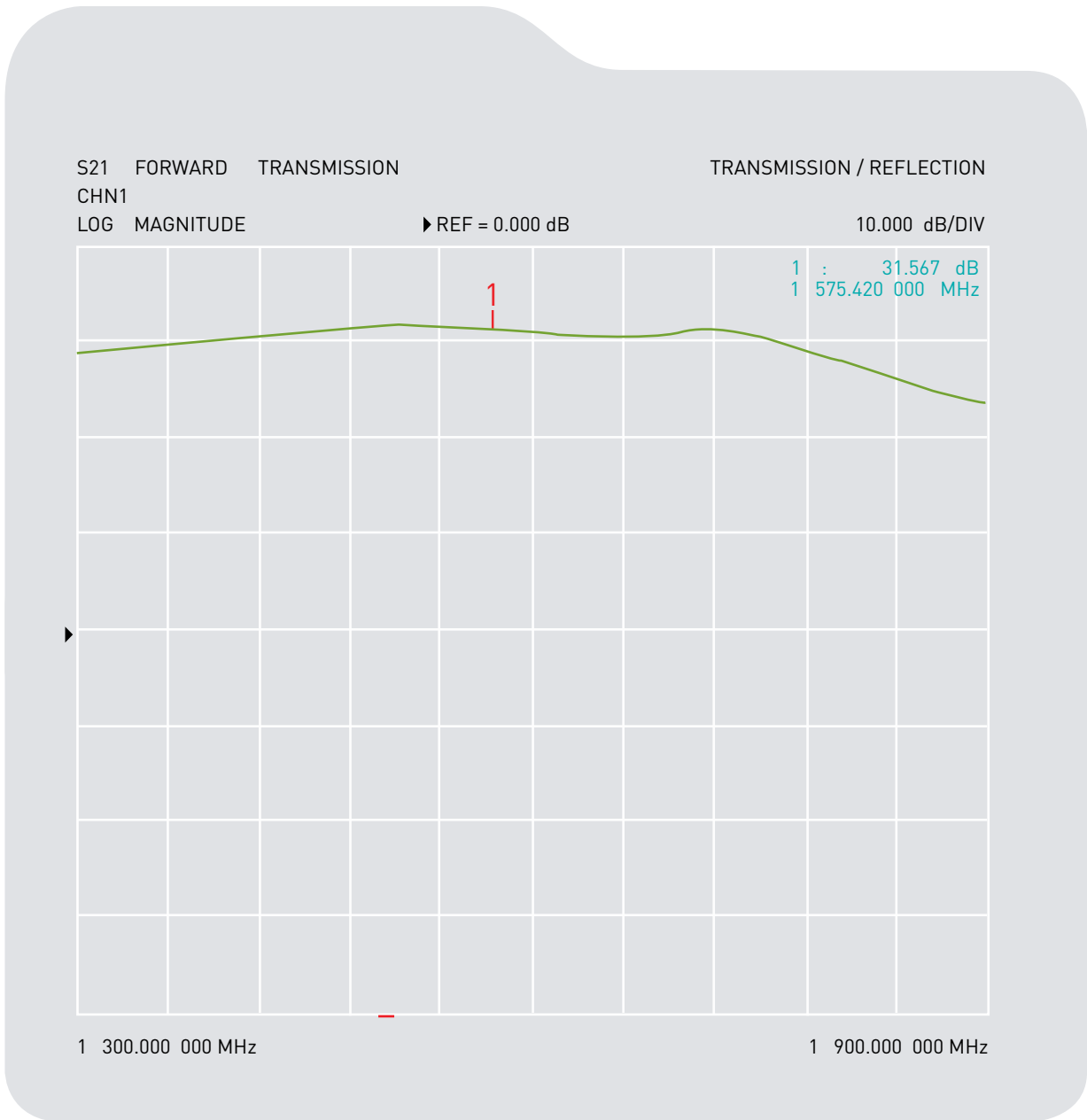

4.4 Noise Figure

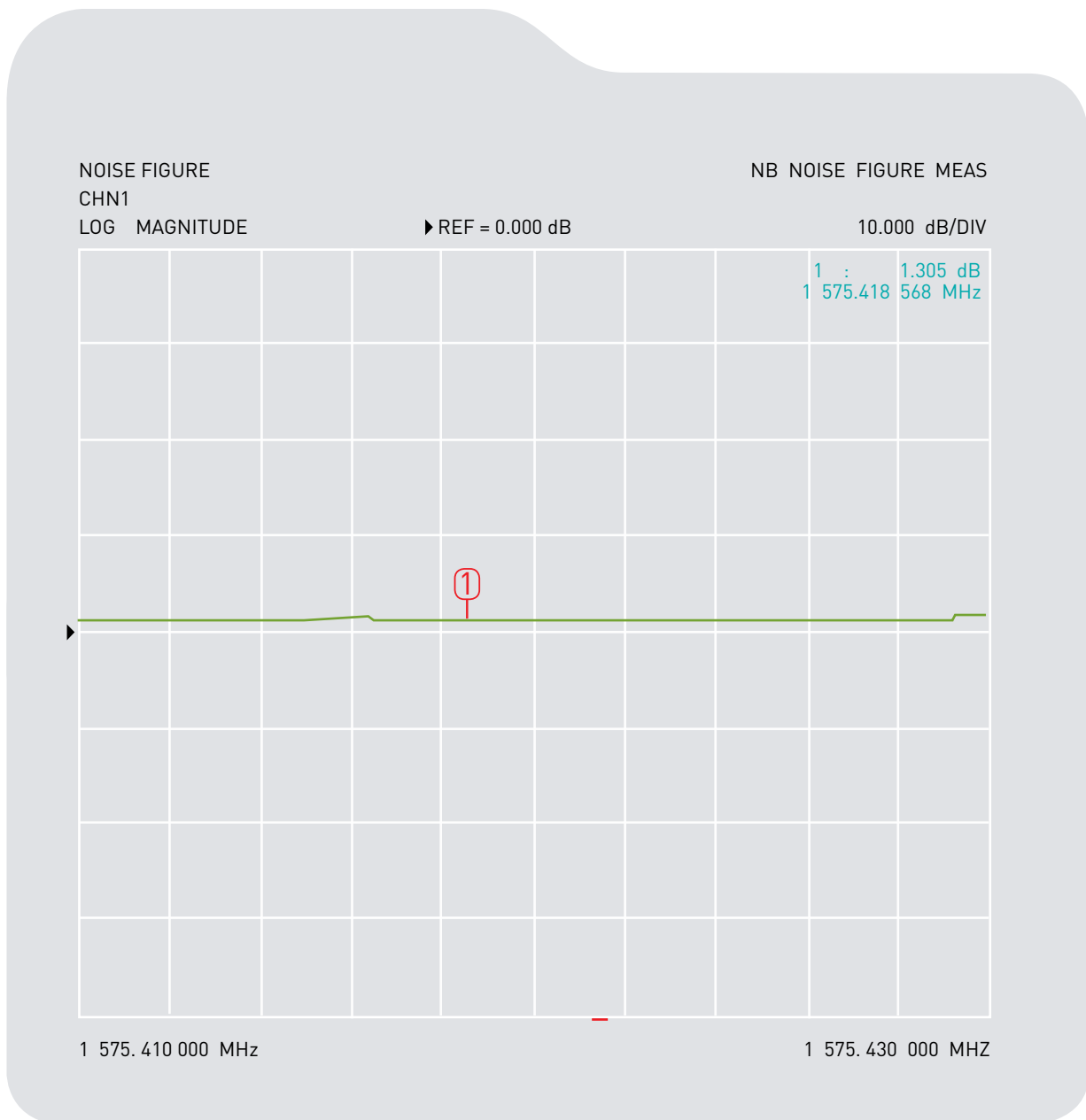

5. Drawings

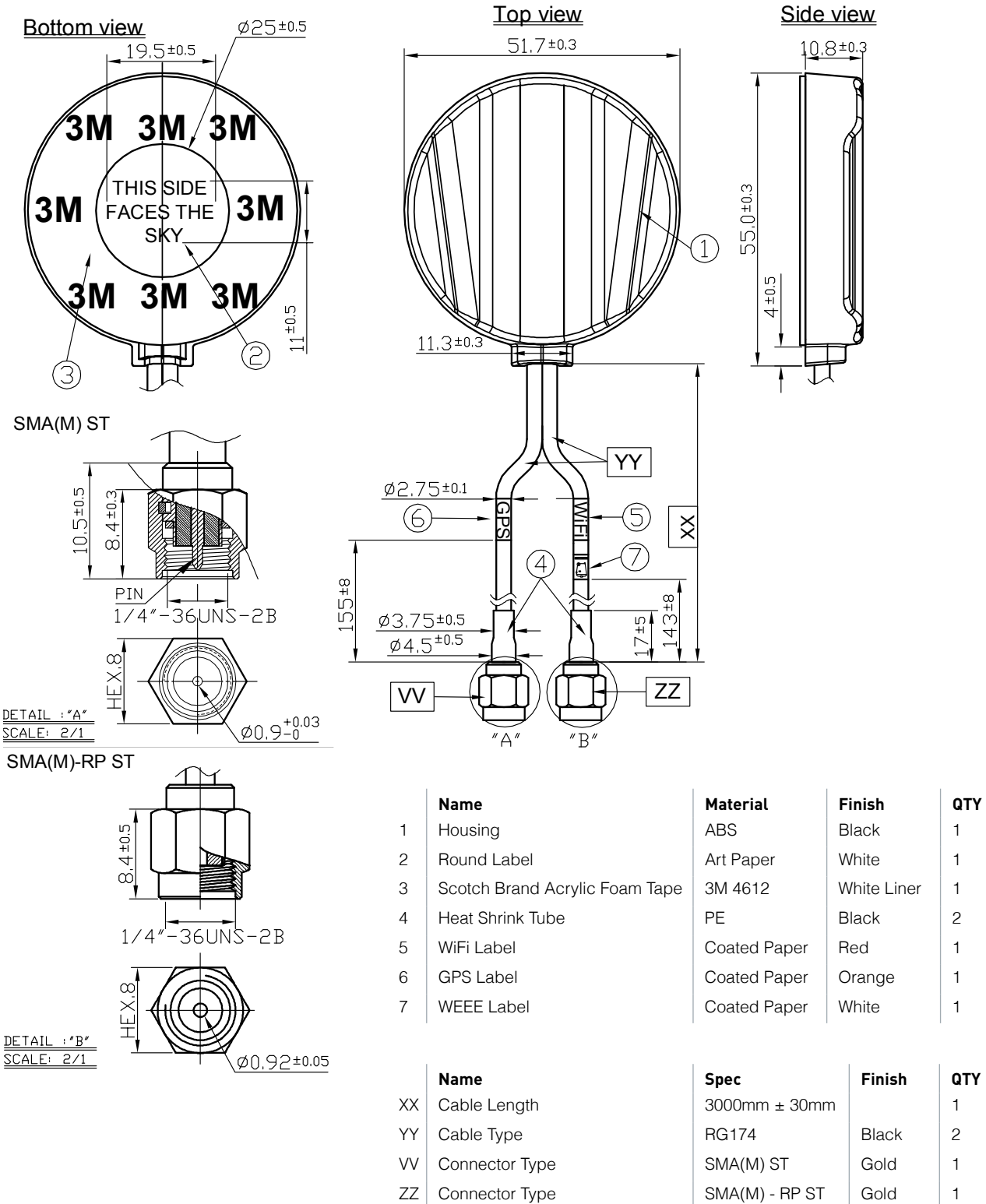

6. Packaging

1 pcs antenna per small PE bag

80 small PE bag per box

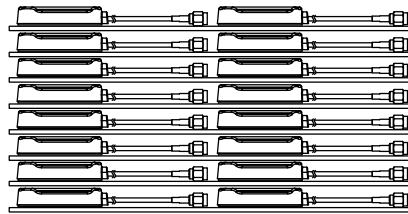
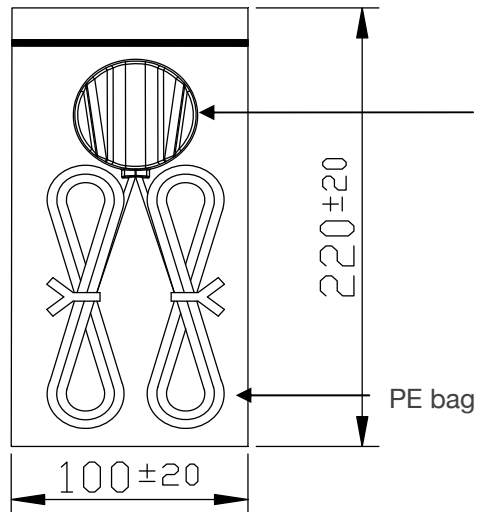

← 10 pcs/pad

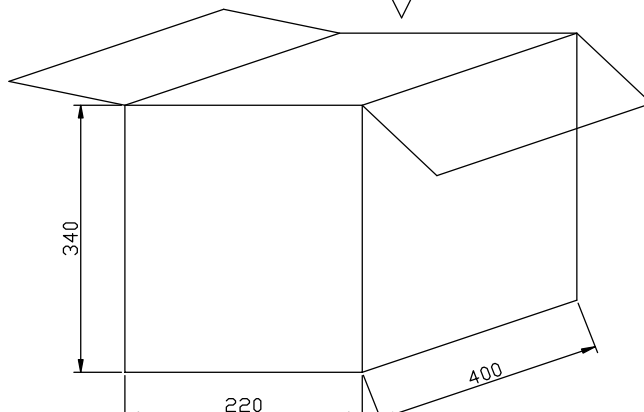

← 80 pcs per carton

Taoglas makes no warranties based on the accuracy or completeness of the contents of this document and reserves the right to make changes to specifications and product descriptions at any time without

notice. Taoglas reserves all rights to this document and the information contained herein.

Reproduction, use or disclosure to third parties without express permission is strictly prohibited.

Copyright © Taoglas Ltd.