

Rail-to-rail 1.1 V dual and quad nanopower comparators

Datasheet - production data

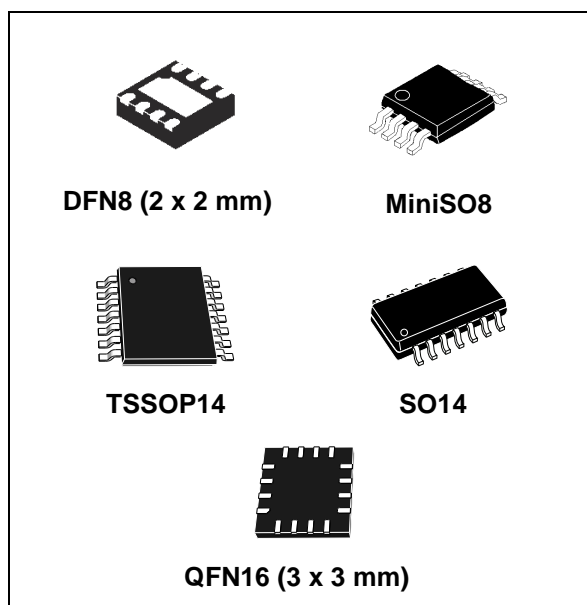

- Quad version available in SO14, TSSOP14 and QFN16 3 x 3 mm package

Related product

- See the TS881 datasheet for single operator with smaller package.

Applications

- Portable systems
- Signal conditioning
- Medical

Description

The TS882 is a dual and the TS884 device a quad comparator featuring ultra-low supply current (220 nA typical per operator with output high, $V_{CC} = 1.2$ V, no load) with rail-to-rail input and output capability. The performance of these comparators allows them to be used in a wide range of portable applications. The TS882 and TS884 devices minimize battery supply leakage and therefore enhance battery lifetime.

Operating from 1.1 to 5.5 V supply voltage, these comparators can be used over a wide temperature range (-40 to +125 °C) keeping the current consumption at an ultra-low level.

Features

- Ultra-low current consumption: 220 nA typ./op.
- Propagation delay: 2 μ s typ.
- Rail-to-rail inputs
- Push-pull outputs
- Supply operation from 1.1 V to 5.5 V
- Wide temperature range: -40 to +125 °C
- ESD tolerance: 8 kV HBM / 300 V MM
- Dual version available in MiniSO8 and DFN8 (2 x 2 mm) package

Table 1. Device summary

Order codes	Temperature range	Packages	Packaging	Marking
TS882IST	-40 to +125 °C	MiniSO8	Tape and reel	K514
TS882IQ2T		DFN8 2 x 2 mm		K56
TS884IDT	-40 to +125 °C	SO14	Tape and reel	S884I
TS884IPT		TSSOP14		S884I
TS884IQ4T		QFN16 3 x 3 mm		K514

Contents

1	Pin description	3
2	Absolute maximum ratings and operating conditions	4
3	Electrical characteristics	5
4	Package information	16
4.1	DFN8 2 x 2 mm package mechanical data	17
4.2	MiniSO8 package information	19
4.3	SO14 package information	20
4.4	QFN16 3 x 3 package information	21
4.5	TSSOP14 package information	24
5	Revision history	25

1 Pin description

Figure 1. Pin connections TS882 (top view)

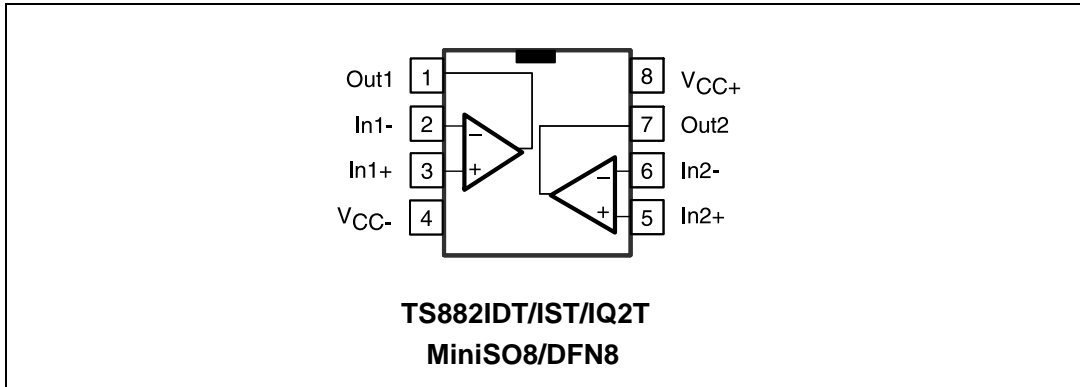
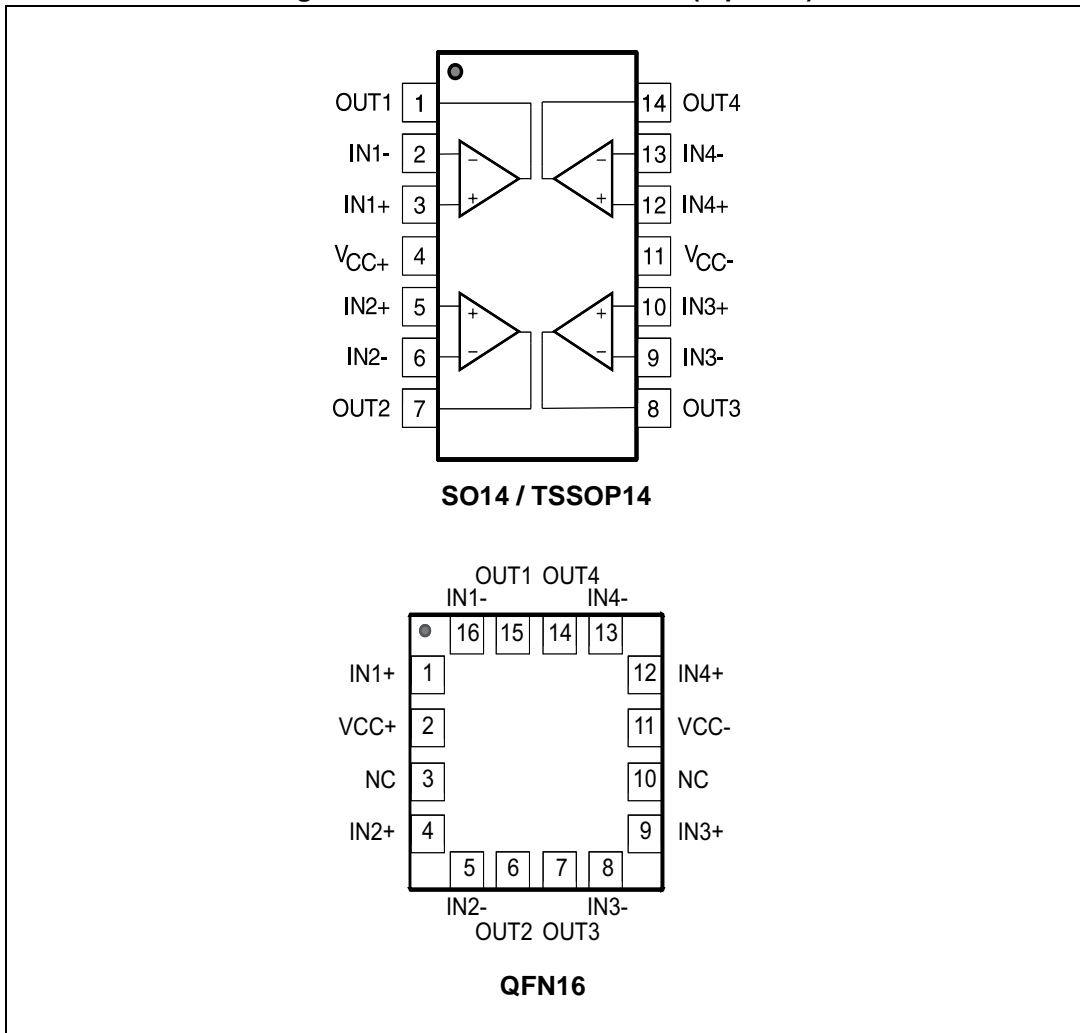

Figure 2. Pin connections TS884 (top view)



2 Absolute maximum ratings and operating conditions

Table 2. Absolute maximum ratings

Symbol	Parameter	Value	Unit
V_{CC}	Supply voltage ⁽¹⁾	6	V
V_{ID}	Differential input voltage ⁽²⁾	±6	V
V_{IN}	Input voltage range	$(V_{CC-}) - 0.3$ to $(V_{CC+}) + 0.3$	V
R_{THJA}	Thermal resistance junction to ambient (TS882) ⁽³⁾		°C/W
	MiniSO8	190	
	DFN8 2 x 2 mm	57	
	Thermal resistance junction to ambient (TS884) ⁽³⁾		
	SO14	105	
	TSSOP14	100	
	QFN16 3 x 3 mm	45	
T_{STG}	Storage temperature	-65 to +150	°C
T_J	Junction temperature	150	°C
T_{LEAD}	Lead temperature (soldering 10 seconds)	260	°C
ESD	Human body model (HBM) ⁽⁴⁾	8	kV
	Machine model (MM) ⁽⁵⁾	300	V
	Charged device model (CDM) ⁽⁶⁾	1300	
	Latch-up immunity	200	mA

1. All voltage values, except differential voltages, are referenced to V_{CC-} . V_{CC} is defined as the difference between V_{CC+} and V_{CC-} .
2. The magnitude of input and output voltages must never exceed the supply rail ±0.3 V.
3. Short-circuits can cause excessive heating. These values are typical.
4. According to JEDEC standard JESD22-A114F.
5. According to JEDEC standard JESD22-A115A.
6. According to ANSI/ESD STM5.3.1.

Table 3. Operating conditions

Symbol	Parameter	Value	Unit
T_{oper}	Operating temperature range	-40 to +125	°C
V_{CC}	Supply voltage -40 °C < T_{amb} < +125 °C	1.1 to 5.5	V
V_{ICM}	Common mode input voltage range -40 °C < T_{amb} < +85 °C -40 °C < T_{amb} < +125 °C	$(V_{CC-}) - 0.2$ to $(V_{CC+}) + 0.2$ (V_{CC-}) to $(V_{CC+}) + 0.2$	V

3 Electrical characteristics

Table 4. $V_{CC} = +1.2\text{ V}$, $T_{amb} = +25\text{ °C}$, $V_{ICM} = V_{CC}/2$ (unless otherwise specified)⁽¹⁾

Symbol	Parameter	Test conditions	Min.	Typ.	Max.	Unit
V_{IO}	Input offset voltage ⁽²⁾	$T_{amb} = +25\text{ °C}$ $-40\text{ °C} < T_{amb} < +125\text{ °C}$	-6	1	6	mV
ΔV_{IO}	Input offset voltage drift	$-40\text{ °C} < T_{amb} < +125\text{ °C}$		3		$\mu\text{V}/\text{°C}$
V_{HYST}	Input hysteresis voltage ⁽³⁾	$T_{amb} = +25\text{ °C}$ $-40\text{ °C} < T_{amb} < +125\text{ °C}$	1.5	2.4	4.2	mV
I_{IO}	Input offset current ⁽⁴⁾	$T_{amb} = +25\text{ °C}$ $-40\text{ °C} < T_{amb} < +125\text{ °C}$			10 100	pA
I_{IB}	Input bias current ⁽⁴⁾	$T_{amb} = +25\text{ °C}$ $-40\text{ °C} < T_{amb} < +125\text{ °C}$		1	10 100	pA
I_{CC}	Supply current per operator	No load, output low, $V_{ID} = -0.1\text{ V}$ $-40\text{ °C} < T_{amb} < +125\text{ °C}$ No load, output high, $V_{ID} = +0.1\text{ V}$ $-40\text{ °C} < T_{amb} < +125\text{ °C}$		300 220	450 350	nA
I_{SC}	Short-circuit current	Source Sink		1.0 1.7		mA
V_{OH}	Output voltage high	$I_{source} = 0.2\text{ mA}$ $-40\text{ °C} < T_{amb} < +85\text{ °C}$ $-40\text{ °C} < T_{amb} < +125\text{ °C}$	1.13 1.10 1.00	1.15		V
V_{OL}	Output voltage low	$I_{sink} = 0.2\text{ mA}$ $-40\text{ °C} < T_{amb} < +85\text{ °C}$ $-40\text{ °C} < T_{amb} < +125\text{ °C}$		35	50 60 70	mV
CMRR	Common mode rejection ratio	$0 < V_{ICM} < V_{CC}$ $-40\text{ °C} < T_{amb} < +125\text{ °C}$	50	68		dB
T_{PLH}	Propagation delay (low to high)	$f = 1\text{ kHz}$, $C_L = 30\text{ pF}$, $R_L = 1\text{ M}\Omega$ Overdrive = 10 mV $-40\text{ °C} < T_{amb} < +125\text{ °C}$ Overdrive = 100 mV $-40\text{ °C} < T_{amb} < +125\text{ °C}$		5.5 2.1	11 13 3.1 3.4	μs
T_{PHL}	Propagation delay (high to low)	$f = 1\text{ kHz}$, $C_L = 30\text{ pF}$, $R_L = 1\text{ M}\Omega$ Overdrive = 10 mV $-40\text{ °C} < T_{amb} < +125\text{ °C}$ Overdrive = 100 mV $-40\text{ °C} < T_{amb} < +125\text{ °C}$		5.1 1.9	8 10 2.6 3.1	μs
T_R	Rise time (10% to 90%)	$C_L = 30\text{ pF}$, $R_L = 1\text{ M}\Omega$		100		ns

Table 4. $V_{CC} = +1.2\text{ V}$, $T_{amb} = +25\text{ °C}$, $V_{ICM} = V_{CC}/2$ (unless otherwise specified)⁽¹⁾ (continued)

Symbol	Parameter	Test conditions	Min.	Typ.	Max.	Unit
T_F	Fall time (90% to 10%)	$C_L = 30\text{ pF}$, $R_L = 1\text{ M}\Omega$		110		ns
T_{ON}	Power-up time			1.1	1.7	ms

1. All values over the temperature range are guaranteed through correlation and simulation. No production test is performed at the temperature range limits.
2. The offset is defined as the average value of positive and negative trip points (input voltage differences requested to change the output state in each direction).
3. The hysteresis is a built-in feature of the TS882 device. It is defined as the voltage difference between the trip points.
4. Maximum values include unavoidable inaccuracies of the industrial tests.

Table 5. $V_{CC} = +2.7\text{ V}$, $T_{amb} = +25\text{ °C}$, $V_{ICM} = V_{CC}/2$ (unless otherwise specified)⁽¹⁾

Symbol	Parameter	Test conditions	Min.	Typ.	Max.	Unit
V_{IO}	Input offset voltage ⁽²⁾	$T_{amb} = +25\text{ °C}$ $-40\text{ °C} < T_{amb} < +125\text{ °C}$	-6	1	6	mV
ΔV_{IO}	Input offset voltage drift	$-40\text{ °C} < T_{amb} < +125\text{ °C}$		3		$\mu\text{V}/\text{°C}$
V_{HYST}	Input hysteresis voltage ⁽³⁾	$T_{amb} = +25\text{ °C}$ $-40\text{ °C} < T_{amb} < +125\text{ °C}$	1.6	2.7	4.2	mV
I_{IO}	Input offset current ⁽⁴⁾	$T_{amb} = +25\text{ °C}$ $-40\text{ °C} < T_{amb} < +125\text{ °C}$			10 100	pA
I_{IB}	Input bias current ⁽⁴⁾	$T_{amb} = +25\text{ °C}$ $-40\text{ °C} < T_{amb} < +125\text{ °C}$		1	10 100	pA
I_{CC}	Supply current per operator	No load, output low, $V_{ID} = -0.1\text{ V}$ $-40\text{ °C} < T_{amb} < +125\text{ °C}$ No load, output high, $V_{ID} = +0.1\text{ V}$ $-40\text{ °C} < T_{amb} < +125\text{ °C}$		310 220	450 350	nA
I_{SC}	Short-circuit current	Source Sink		10 13		mA
V_{OH}	Output voltage high	$I_{source} = 2\text{ mA}$ $-40\text{ °C} < T_{amb} < +85\text{ °C}$ $-40\text{ °C} < T_{amb} < +125\text{ °C}$	2.48 2.40 2.10	2.51		V
V_{OL}	Output voltage low	$I_{sink} = 2\text{ mA}$ $-40\text{ °C} < T_{amb} < +85\text{ °C}$ $-40\text{ °C} < T_{amb} < +125\text{ °C}$		130	210 230 310	mV
CMRR	Common mode rejection ratio	$0 < V_{ICM} < V_{CC}$ $-40\text{ °C} < T_{amb} < +125\text{ °C}$	55	74		dB
T_{PLH}	Propagation delay (low to high)	$f = 1\text{ kHz}$, $C_L = 30\text{ pF}$, $R_L = 1\text{ M}\Omega$ Overdrive = 10 mV $-40\text{ °C} < T_{amb} < +125\text{ °C}$ Overdrive = 100 mV $-40\text{ °C} < T_{amb} < +125\text{ °C}$		6.4 2.3	12 14 3.0 3.7	μs
T_{PHL}	Propagation delay (high to low)	$f = 1\text{ kHz}$, $C_L = 30\text{ pF}$, $R_L = 1\text{ M}\Omega$ Overdrive = 10 mV $-40\text{ °C} < T_{amb} < +125\text{ °C}$ Overdrive = 100 mV $-40\text{ °C} < T_{amb} < +125\text{ °C}$		6.4 2.2	12 14 3.0 3.7	μs
T_R	Rise time (10% to 90%)	$C_L = 30\text{ pF}$, $R_L = 1\text{ M}\Omega$		120		ns
T_F	Fall time (90% to 10%)	$C_L = 30\text{ pF}$, $R_L = 1\text{ M}\Omega$		130		ns
T_{ON}	Power-up time			1.1	1.7	ms

1. All values over the temperature range are guaranteed through correlation and simulation. No production test is performed at the temperature range limits.
2. The offset is defined as the average value of positive and negative trip points (input voltage differences requested to change the output state in each direction).
3. The hysteresis is a built-in feature of the TS882. It is defined as the voltage difference between the trip points.
4. Maximum values include unavoidable inaccuracies of the industrial tests.



Table 6. $V_{CC} = +5\text{ V}$, $T_{amb} = +25\text{ }^\circ\text{C}$, $V_{ICM} = V_{CC}/2$ (unless otherwise specified)⁽¹⁾

Symbol	Parameter	Test conditions	Min.	Typ.	Max.	Unit
V_{IO}	Input offset voltage ⁽²⁾	$T_{amb} = +25\text{ }^\circ\text{C}$ $-40\text{ }^\circ\text{C} < T_{amb} < +125\text{ }^\circ\text{C}$	-6	1	6	mV
ΔV_{IO}	Input offset voltage drift	$-40\text{ }^\circ\text{C} < T_{amb} < +125\text{ }^\circ\text{C}$		3		$\mu\text{V}/^\circ\text{C}$
V_{HYST}	Input hysteresis voltage ⁽³⁾	$T_{amb} = +25\text{ }^\circ\text{C}$ $-40\text{ }^\circ\text{C} < T_{amb} < +125\text{ }^\circ\text{C}$	1.6	3.1	4.2	mV
I_{IO}	Input offset current ⁽⁴⁾	$T_{amb} = +25\text{ }^\circ\text{C}$ $-40\text{ }^\circ\text{C} < T_{amb} < +125\text{ }^\circ\text{C}$			10 100	pA
I_{IB}	Input bias current ⁽⁴⁾	$T_{amb} = +25\text{ }^\circ\text{C}$ $-40\text{ }^\circ\text{C} < T_{amb} < +125\text{ }^\circ\text{C}$		1	10 100	pA
I_{CC}	Supply current per operator	No load, output low, $V_{ID} = -0.1\text{ V}$ $-40\text{ }^\circ\text{C} < T_{amb} < +125\text{ }^\circ\text{C}$ No load, output high, $V_{ID} = +0.1\text{ V}$ $-40\text{ }^\circ\text{C} < T_{amb} < +125\text{ }^\circ\text{C}$		350 250	500 400	nA
I_{SC}	Short-circuit current	Source Sink		32 32		mA
V_{OH}	Output voltage high	$I_{source} = 2\text{ mA}$ $-40\text{ }^\circ\text{C} < T_{amb} < +85\text{ }^\circ\text{C}$ $-40\text{ }^\circ\text{C} < T_{amb} < +125\text{ }^\circ\text{C}$	4.86 4.75 4.60	4.88		V
V_{OL}	Output voltage low	$I_{sink} = 2\text{ mA}$ $-40\text{ }^\circ\text{C} < T_{amb} < +85\text{ }^\circ\text{C}$ $-40\text{ }^\circ\text{C} < T_{amb} < +125\text{ }^\circ\text{C}$		90	130 170 280	mV
CMRR	Common mode rejection ratio	$0 < V_{ICM} < V_{CC}$ $-40\text{ }^\circ\text{C} < T_{amb} < +125\text{ }^\circ\text{C}$	55	78		dB
SVR	Supply voltage rejection	$\Delta V_{CC} = 1.2\text{ V to } 5\text{ V}$ $-40\text{ }^\circ\text{C} < T_{amb} < +125\text{ }^\circ\text{C}$	65	80		dB
T_{PLH}	Propagation delay (low to high)	$f = 1\text{ kHz}$, $C_L = 30\text{ pF}$, $R_L = 1\text{ M}\Omega$ Overdrive = 10 mV $-40\text{ }^\circ\text{C} < T_{amb} < +125\text{ }^\circ\text{C}$ Overdrive = 100 mV $-40\text{ }^\circ\text{C} < T_{amb} < +125\text{ }^\circ\text{C}$		8.3 2.5	13 22 3.4 4.1	μs
T_{PHL}	Propagation delay (high to low)	$f = 1\text{ kHz}$, $C_L = 30\text{ pF}$, $R_L = 1\text{ M}\Omega$ Overdrive = 10 mV $-40\text{ }^\circ\text{C} < T_{amb} < +125\text{ }^\circ\text{C}$ Overdrive = 100 mV $-40\text{ }^\circ\text{C} < T_{amb} < +125\text{ }^\circ\text{C}$		9.0 2.6	16 19 3.5 4.2	μs
T_R	Rise time (10% to 90%)	$C_L = 30\text{ pF}$, $R_L = 1\text{ M}\Omega$		160		ns

Table 6. $V_{CC} = +5\text{ V}$, $T_{amb} = +25\text{ }^{\circ}\text{C}$, $V_{ICM} = V_{CC}/2$ (unless otherwise specified)⁽¹⁾ (continued)

Symbol	Parameter	Test conditions	Min.	Typ.	Max.	Unit
T_F	Fall time (90% to 10%)	$C_L = 30\text{ pF}$, $R_L = 1\text{ M}\Omega$		150		ns
T_{ON}	Power-up time			1.1	1.7	ms

1. All values over the temperature range are guaranteed through correlation and simulation. No production test is performed at the temperature range limits.
2. The offset is defined as the average value of positive and negative trip points (input voltage differences requested to change the output state in each direction).
3. The hysteresis is a built-in feature of the TS882 device. It is defined as the voltage difference between the trip points.
4. Maximum values include unavoidable inaccuracies of the industrial tests.

Figure 3. Current consumption per operator vs. supply voltage - output low

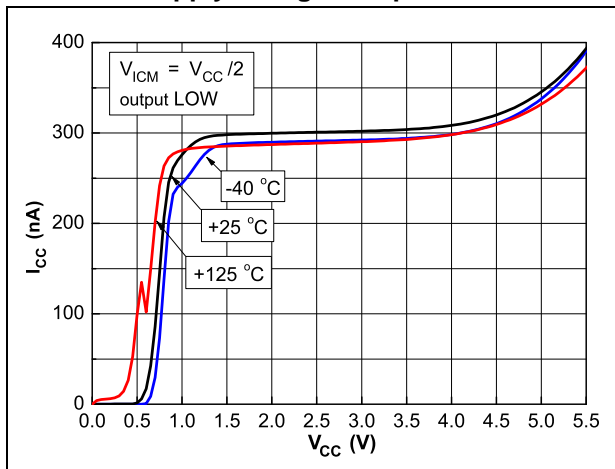

Figure 4. Current consumption per operator vs. supply voltage - output high

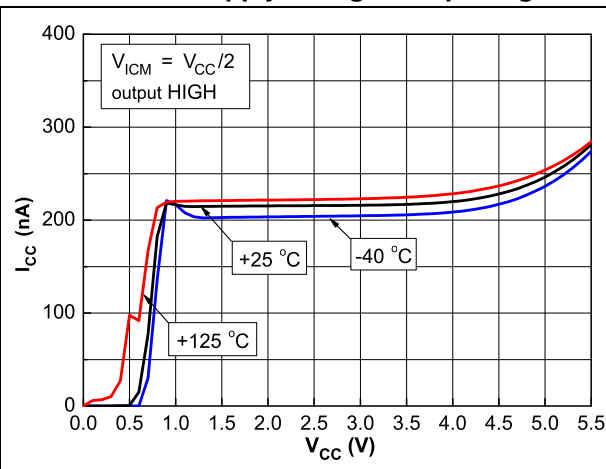

Figure 5. Current consumption per operator vs. input common mode voltage at V_{CC} = 1.2 V

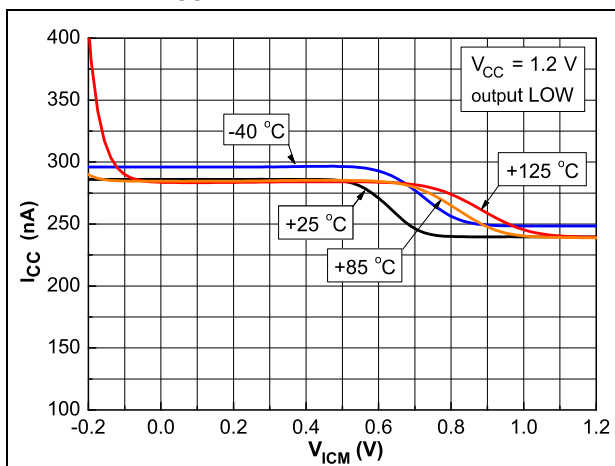

Figure 6. Current consumption per operator vs. input common mode voltage at V_{CC} = 5 V

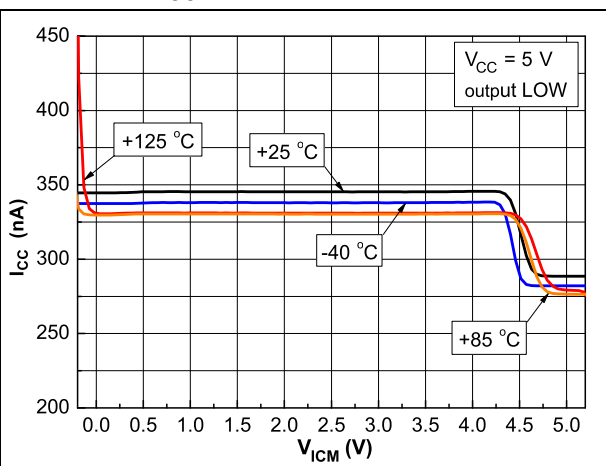

Figure 7. Current consumption per operator vs. temperature

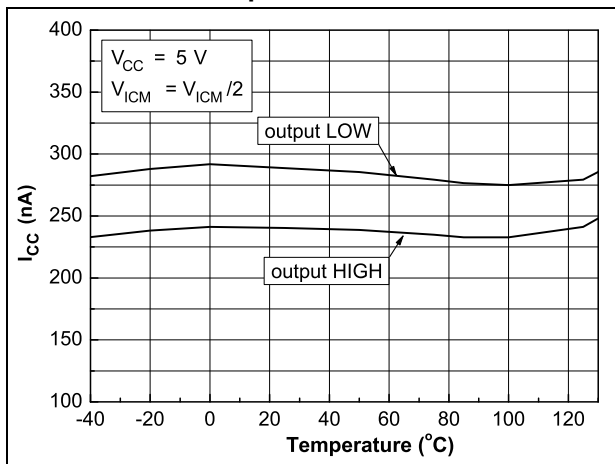

Figure 8. Current consumption per operator vs. toggle frequency

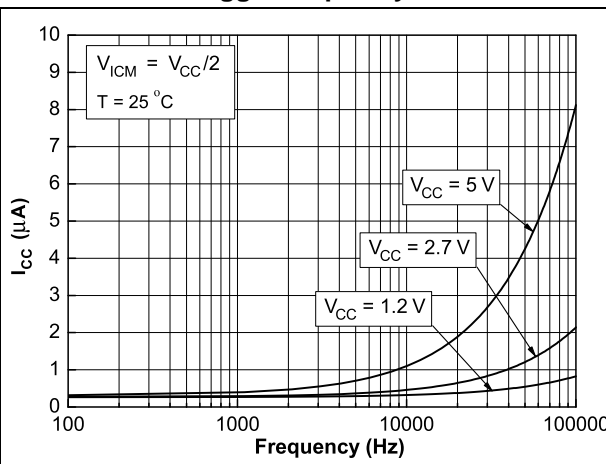

Figure 9. Input offset voltage vs. input common mode voltage at $V_{CC} = 1.2\text{ V}$

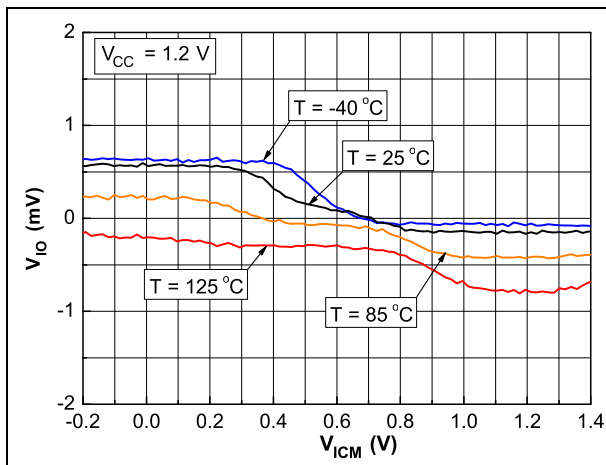

Figure 10. Input hysteresis voltage vs. input common mode voltage at $V_{CC} = 1.2\text{ V}$

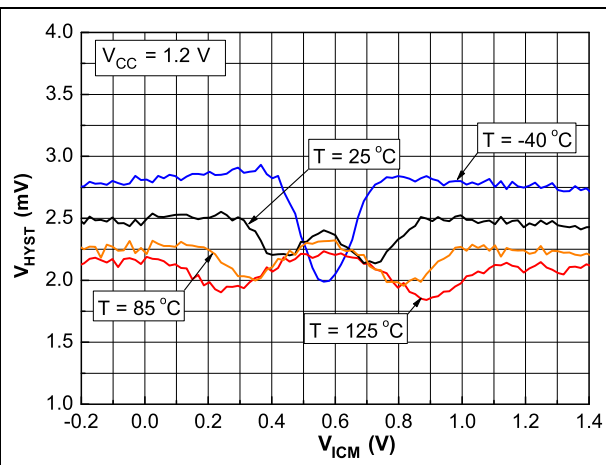

Figure 11. Input offset voltage vs. input common mode voltage at $V_{CC} = 5\text{ V}$

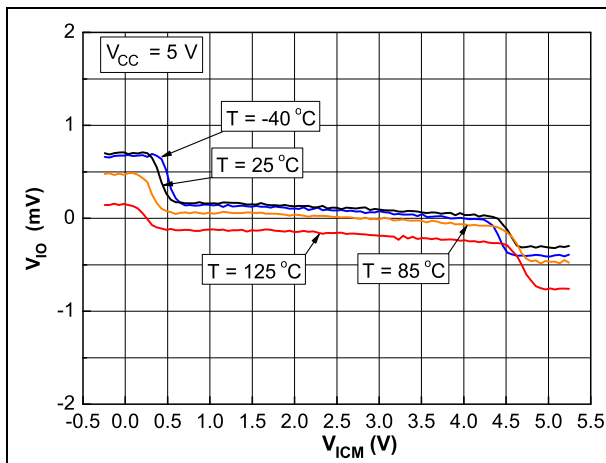

Figure 12. Input hysteresis voltage vs. input common mode voltage at $V_{CC} = 5\text{ V}$

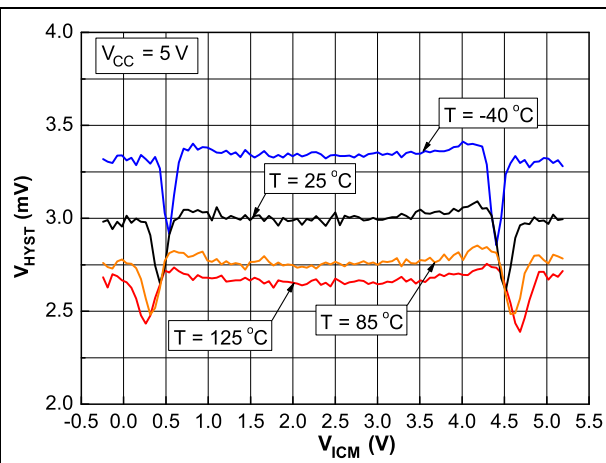

Figure 13. Input offset voltage vs. temperature

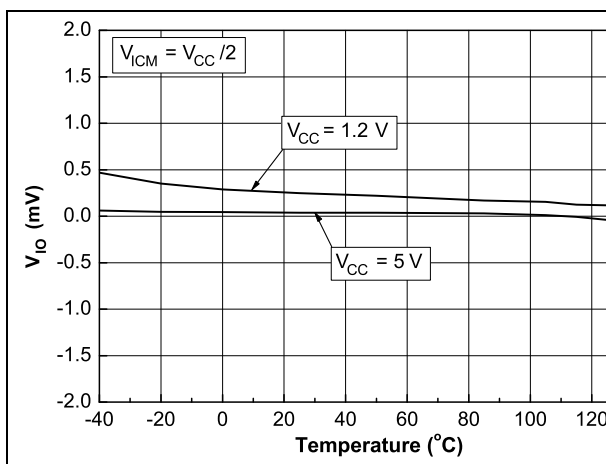

Figure 14. Input hysteresis voltage vs. temperature

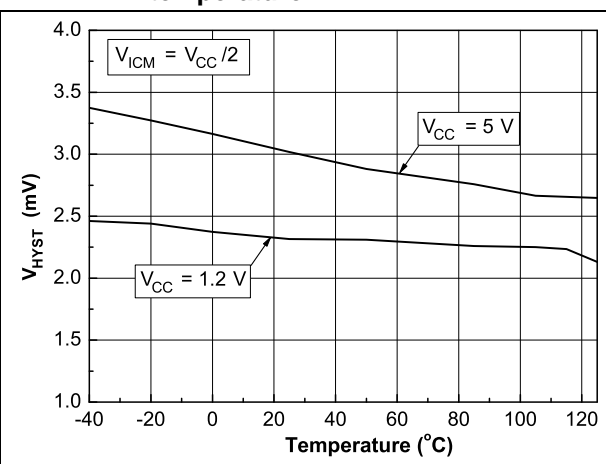

Figure 15. Output voltage drop vs. sink current at $V_{CC} = 1.2\text{ V}$

Figure 16. Output voltage drop vs. source current at $V_{CC} = 1.2\text{ V}$

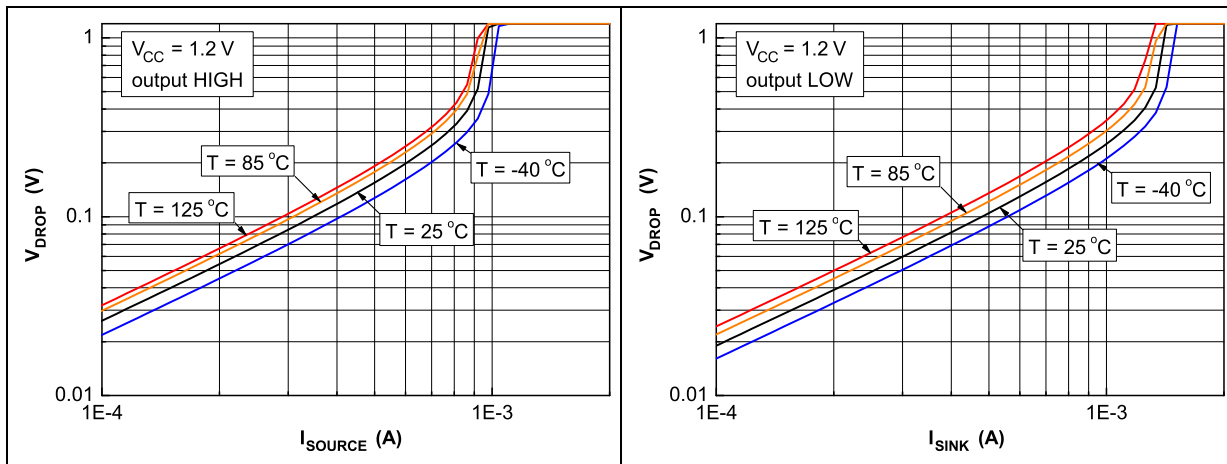

Figure 17. Output voltage drop vs. sink current at $V_{CC} = 2.7\text{ V}$

Figure 18. Output voltage drop vs. source current at $V_{CC} = 2.7\text{ V}$

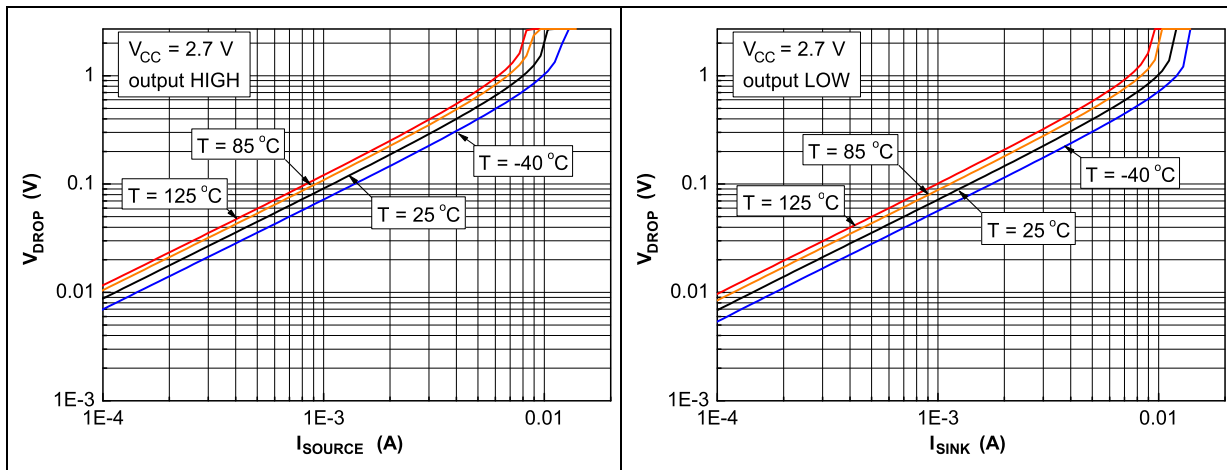

Figure 19. Output voltage drop vs. sink current at $V_{CC} = 5\text{ V}$

Figure 20. Output voltage drop vs. source current at $V_{CC} = 5\text{ V}$

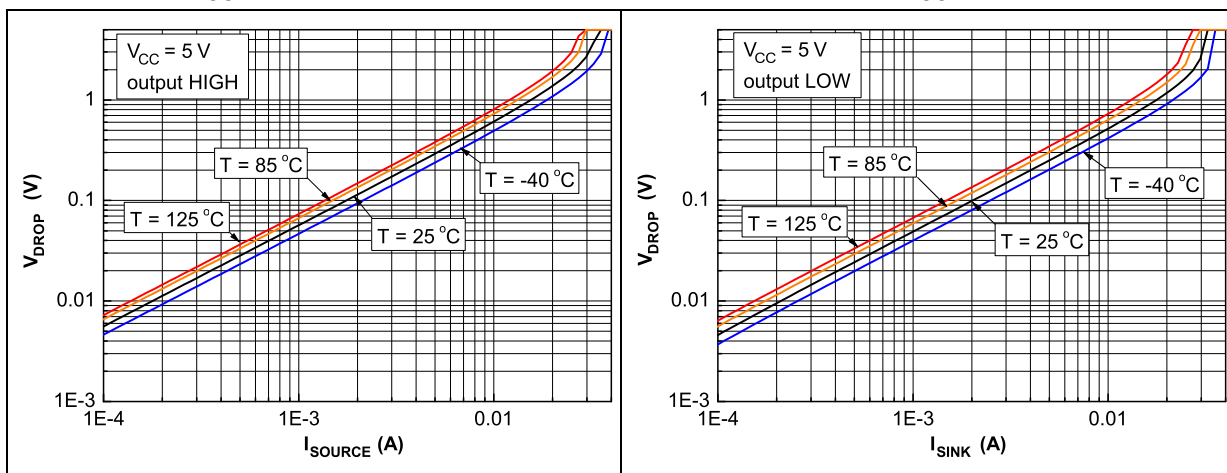

Figure 21. Propagation delay T_{PLH} vs. input common mode voltage at $V_{CC} = 1.2\text{ V}$

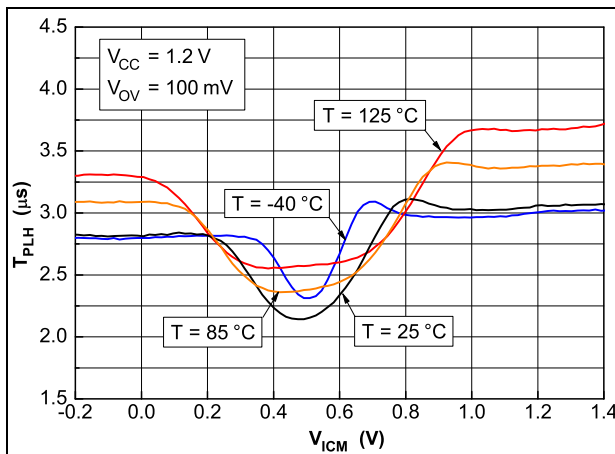

Figure 22. Propagation delay T_{PHL} vs. input common mode voltage at $V_{CC} = 1.2\text{ V}$

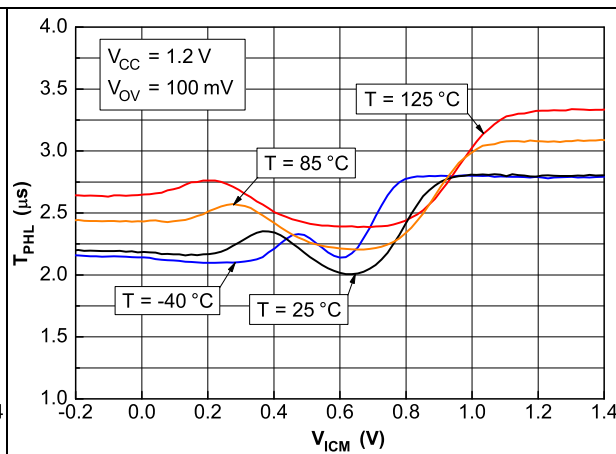

Figure 23. Propagation delay T_{PLH} vs. input common mode voltage at $V_{CC} = 5\text{ V}$

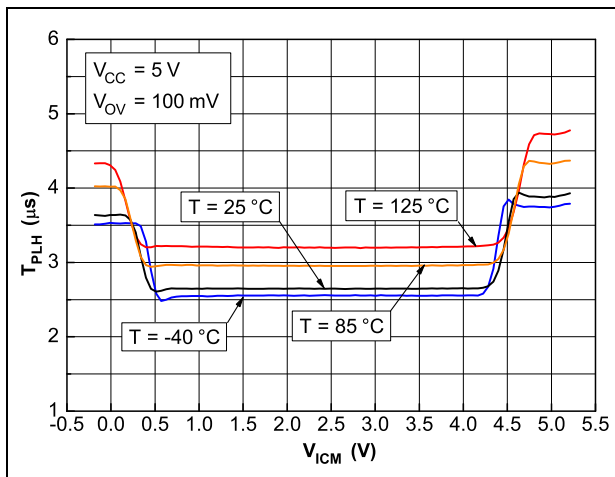

Figure 24. Propagation delay T_{PHL} vs. input common mode voltage at $V_{CC} = 5\text{ V}$

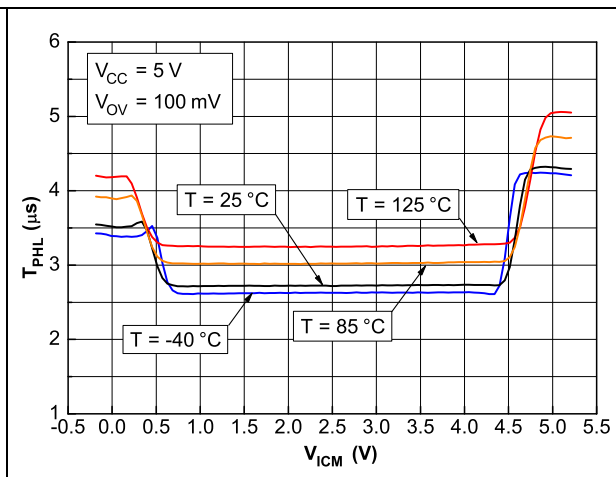

Figure 25. Propagation delay T_{PLH} vs. input signal overdrive at $V_{CC} = 1.2\text{ V}$

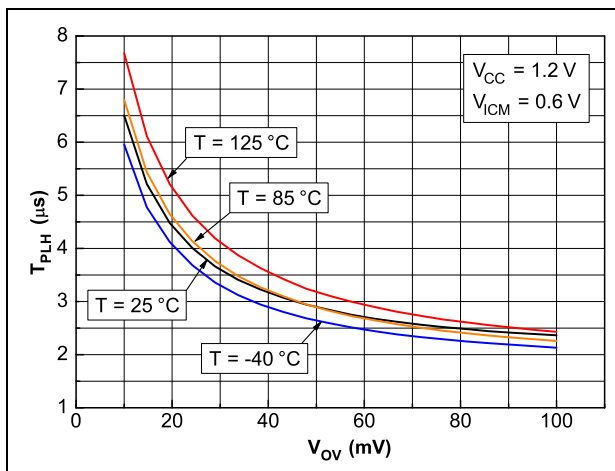

Figure 26. Propagation delay T_{PHL} vs. input signal overdrive at $V_{CC} = 1.2\text{ V}$

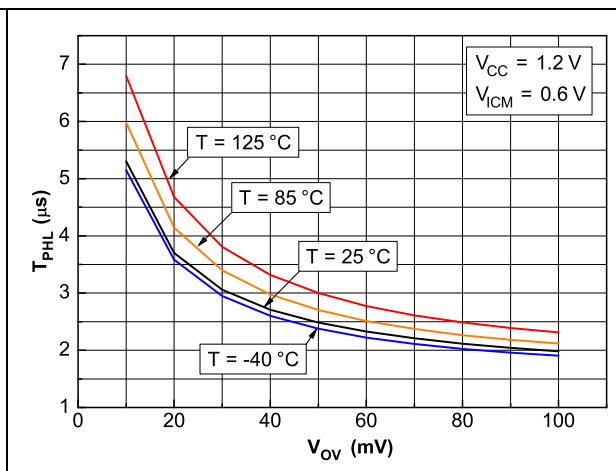

Figure 27. Propagation delay T_{PLH} vs. input signal overdrive at $V_{CC} = 5\text{ V}$

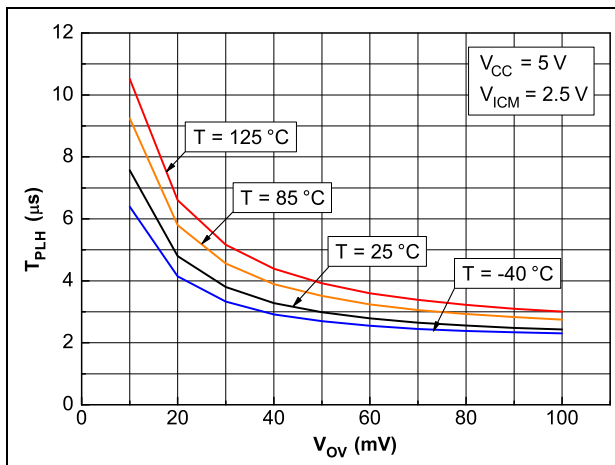

Figure 28. Propagation delay T_{PHL} vs. input signal overdrive at $V_{CC} = 5\text{ V}$

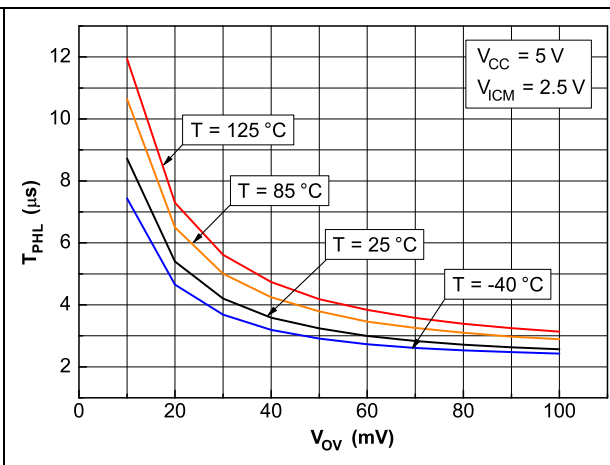

Figure 29. Propagation delay T_{PLH} vs. supply voltage for signal overdrive 10 mV

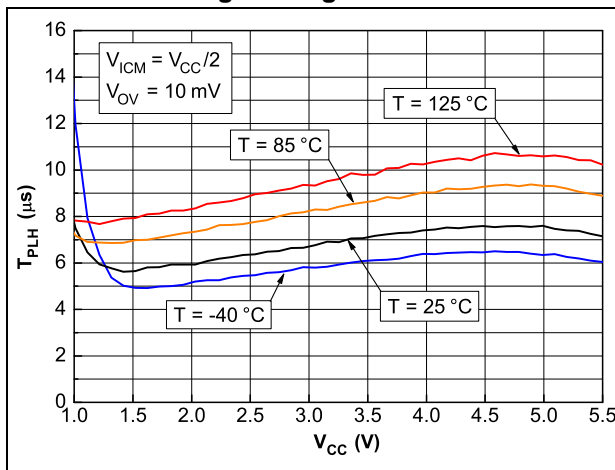

Figure 30. Propagation delay T_{PHL} vs. supply voltage for signal overdrive 10 mV

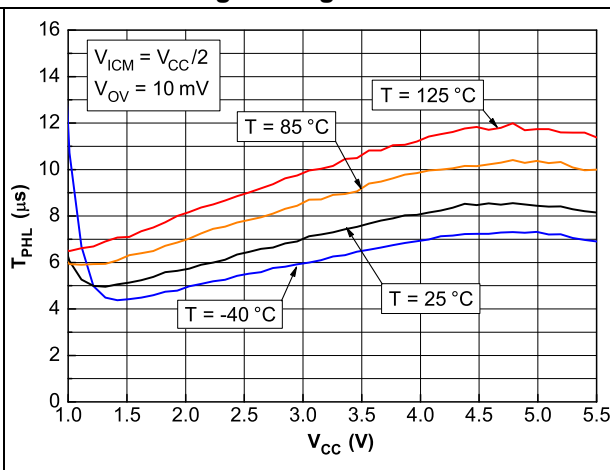

Figure 31. Propagation delay T_{PLH} vs. supply voltage for signal overdrive 100 mV

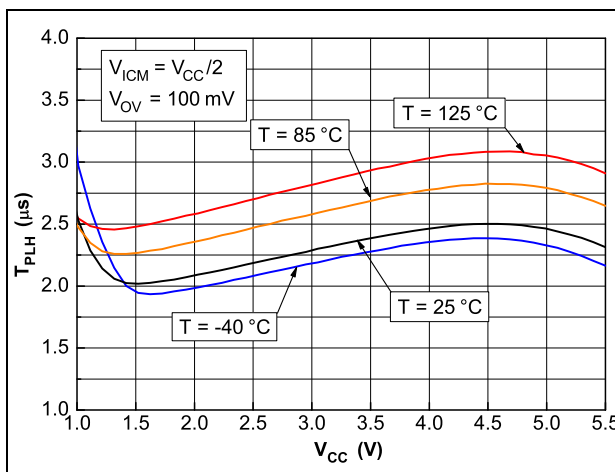

Figure 32. Propagation delay T_{PHL} vs. supply voltage for signal overdrive 100 mV

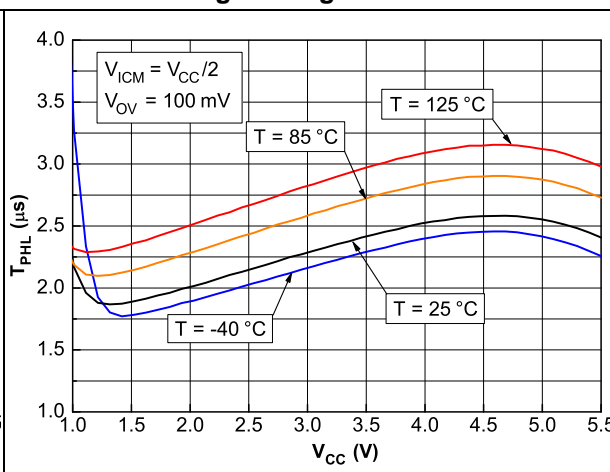

Figure 33. Propagation delay vs. temperature for signal overdrive 10 mV

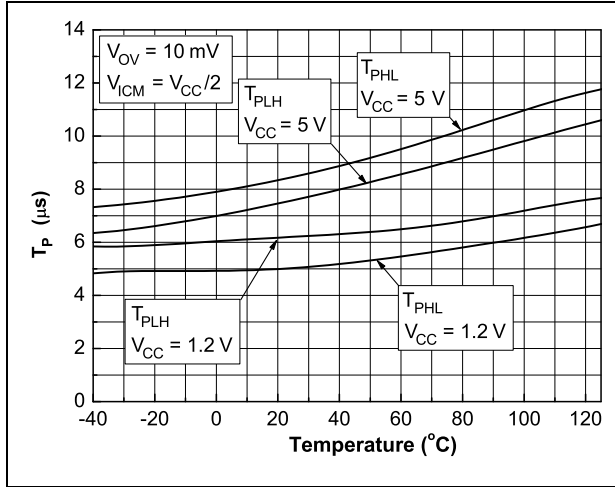
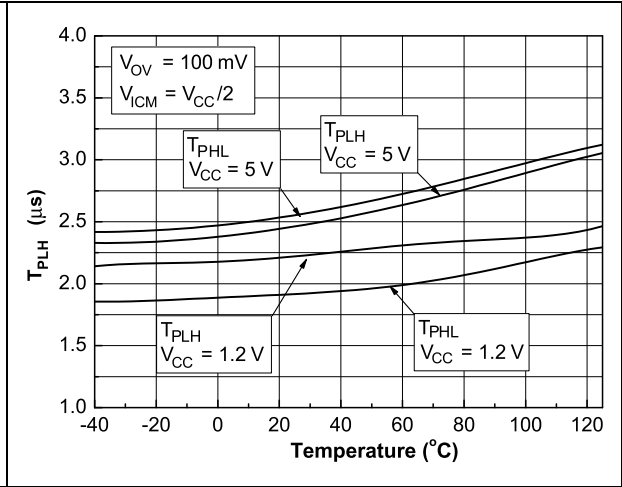

Figure 34. Propagation delay vs. temperature for signal overdrive 100 mV



4 Package information

In order to meet environmental requirements, ST offers these devices in different grades of ECOPACK® packages, depending on their level of environmental compliance. ECOPACK specifications, grade definitions and product status are available at: www.st.com. ECOPACK is an ST trademark.

4.1 DFN8 2 x 2 mm package mechanical data

Figure 35. DFN8 2 x 2 mm package outline

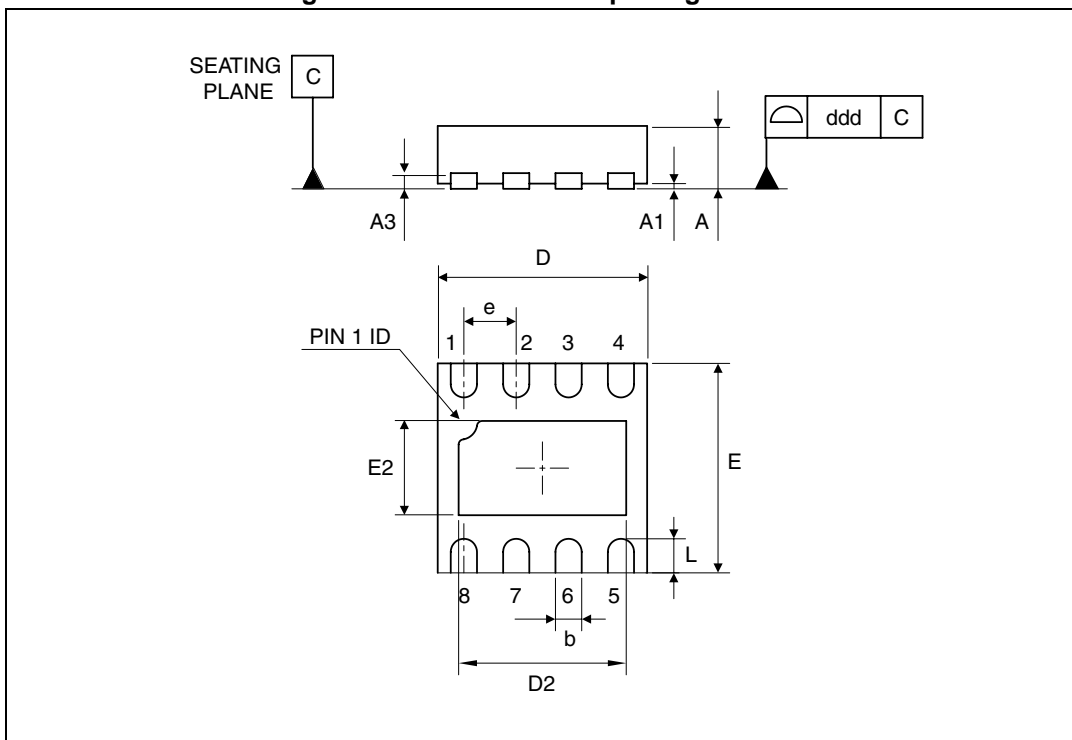
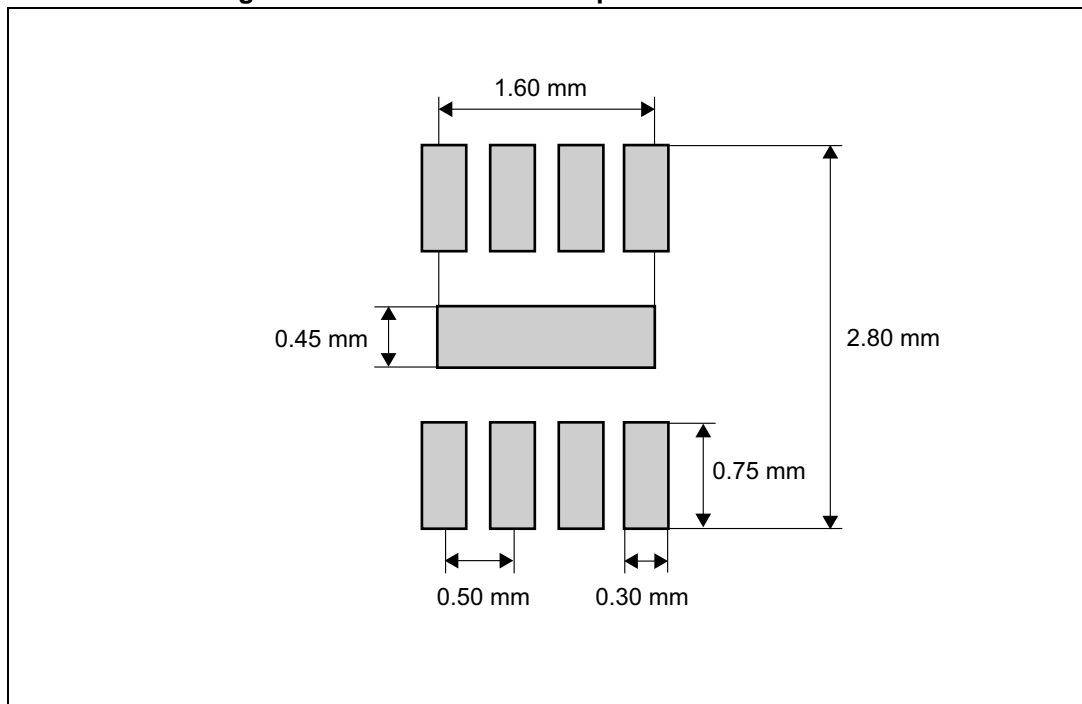

Table 7. DFN8 2 x 2 mm package mechanical data (pitch 0.5 mm)

Symbol	Dimensions					
	Millimeters			Inches		
	Min.	Typ.	Max.	Min.	Typ.	Max.
A	0.51	0.55	0.60	0.020	0.022	0.024
A1			0.05			0.002
A3		0.15			0.006	
b	0.18	0.25	0.30	0.007	0.010	0.012
D	1.85	2.00	2.15	0.073	0.079	0.085
D2	1.45	1.60	1.70	0.057	0.063	0.067
E	1.85	2.00	2.15	0.073	0.079	0.085
E2	0.75	0.90	1.00	0.030	0.035	0.039
e		0.50			0.020	
L			0.50			0.020
ddd			0.08			0.003

Figure 36. DFN8 2 x 2 mm footprint recommendation



4.2 MiniSO8 package information

Figure 37. MiniSO8 package outline

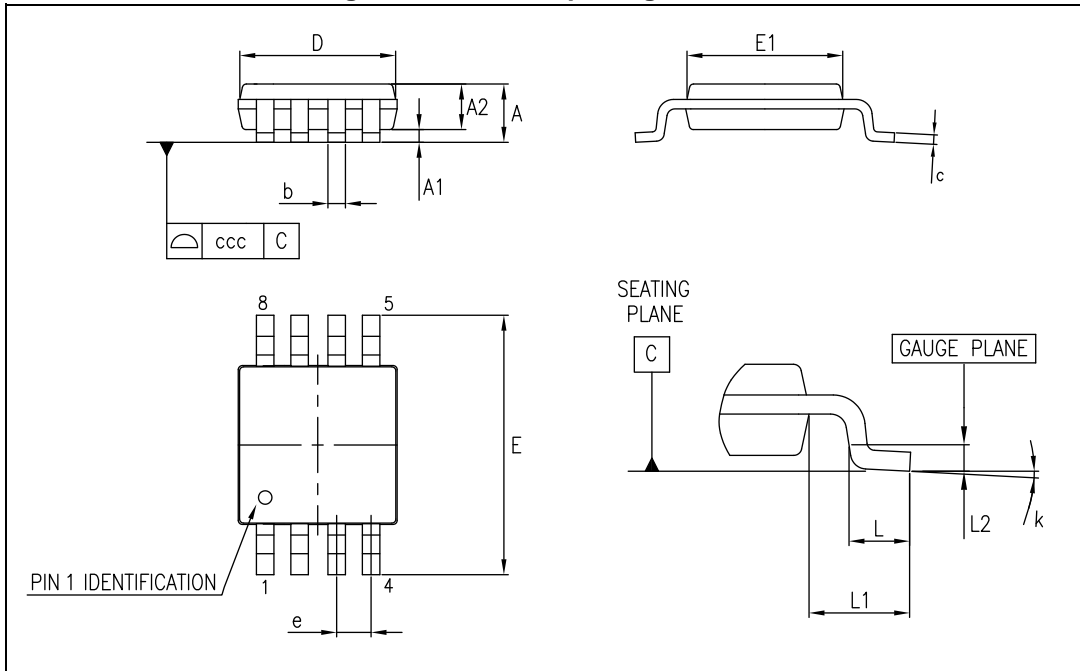

Table 8. MiniSO8 package mechanical data

Symbol	Dimensions					
	Millimeters			Inches		
	Min.	Typ.	Max.	Min.	Typ.	Max.
A			1.10			0.043
A1	0		0.15	0		0.006
A2	0.75	0.85	0.95	0.030	0.033	0.037
b	0.22		0.40	0.009		0.016
c	0.08		0.23	0.003		0.009
D	2.80	3.00	3.20	0.11	0.118	0.126
E	4.65	4.90	5.15	0.183	0.193	0.203
E1	2.80	3.00	3.10	0.11	0.118	0.122
e		0.65			0.026	
L	0.40	0.60	0.80	0.016	0.024	0.031
L1		0.95			0.037	
L2		0.25			0.010	
k	0°		8°	0°		8°
ccc			0.10			0.004

4.3 SO14 package information

Figure 38. SO14 package outline

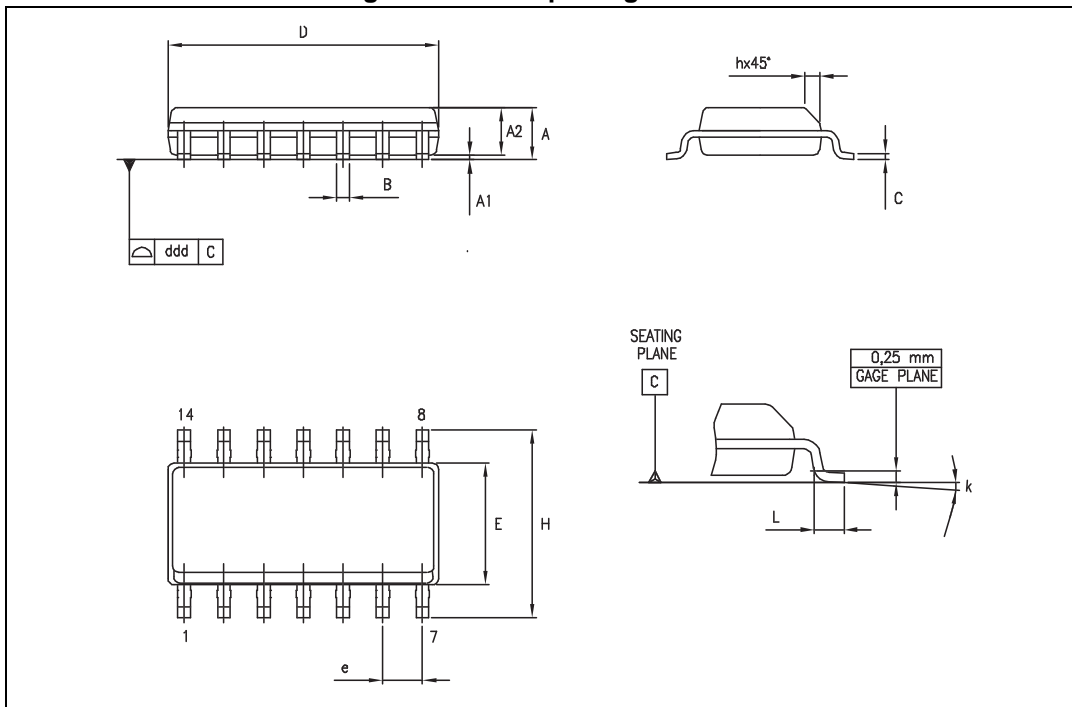

Table 9. SO14 package mechanical data

Dimensions ⁽¹⁾							
Symbol	Millimeters			Inches			Note
	Min.	Typ.	Max.	Min.	Typ.	Max.	
A	1.35		1.75	0.05		0.068	
A1	0.10		0.25	0.004		0.009	
A2	1.10		1.65	0.04		0.06	
B	0.33		0.51	0.01		0.02	
C	0.19		0.25	0.007		0.009	
D	8.55		8.75	0.33		0.34	(2)
E	3.80		4.0	0.15		0.15	
e		1.27			0.05		
H	5.80		6.20	0.22		0.24	
L	0.40		1.27	0.015		0.05	
k	0°		8°	0°		8°	
ddd			0.10			0.004	

1. Drawing dimensions include "Single" and "Matrix" versions.
2. Dimension "D" does not include mold flash, protrusions or gate burrs. Mold flash, protrusions or gate burrs shall not exceed 0.15 mm per side.

4.4 QFN16 3 x 3 package information

Figure 39. QFN16 3 x 3 mm (pitch 0.5 mm) package outline

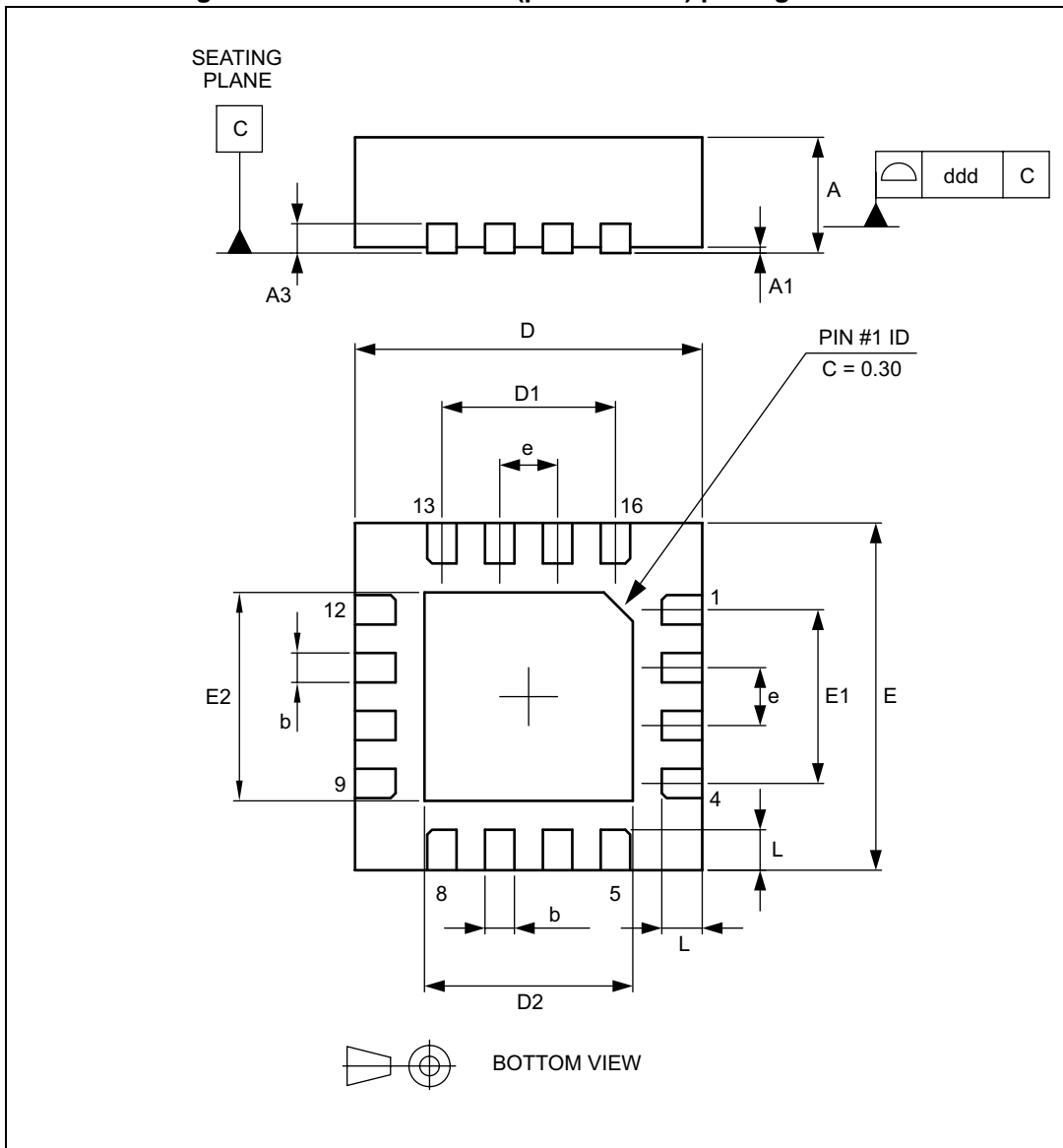
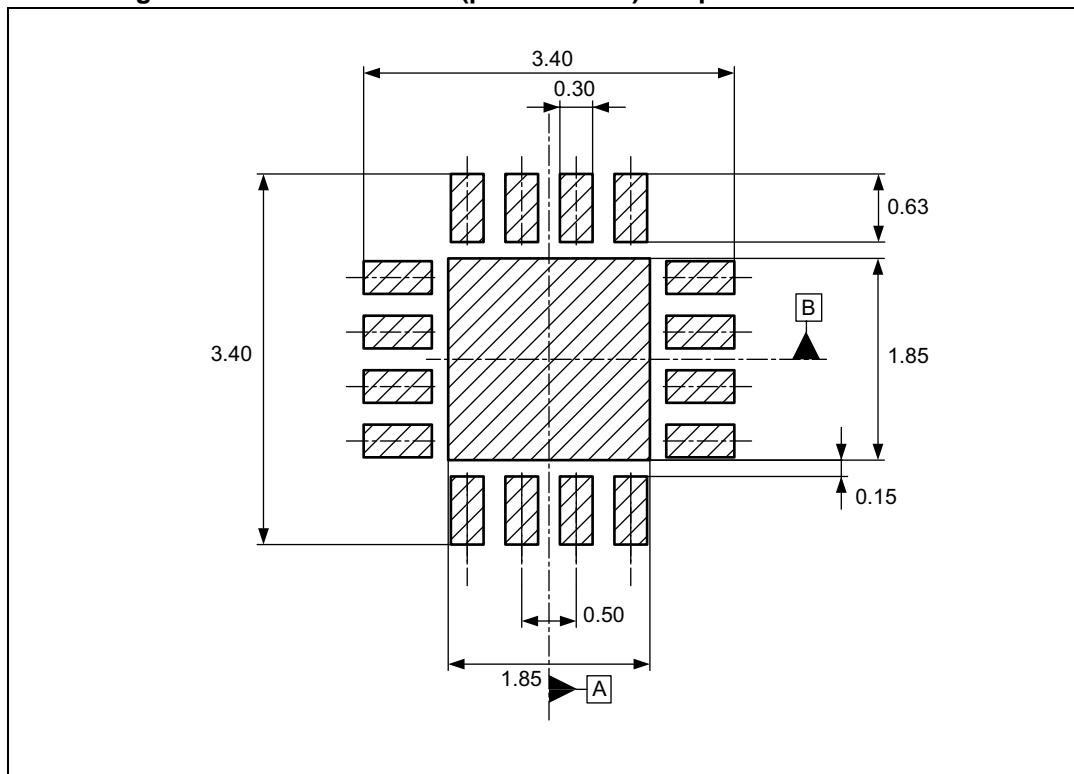

Table 10. QFN16 3 x 3 mm (pitch 0.5 mm) package mechanical data

Symbol	Dimensions					
	Millimeters			Inches		
	Min.	Typ.	Max.	Min.	Typ.	Max.
A	0.80	0.90	1.00	0.031	0.035	0.039
A1		0.02	0.05		0.001	0.002
A3		0.20			0.008	
b	0.18	0.25	0.30	0.007	0.010	0.012
D	2.85	3.00	3.15	0.112	0.118	0.124
D1		1.50			0.059	
D2	See exposed pad variation			See exposed pad variation		
E	2.85	3.00	3.15	0.112	0.118	0.124
E1		1.50			0.059	
E2	See exposed pad variation			See exposed pad variation		
e	0.45	0.50	0.55	0.018	0.020	0.022
L	0.30	0.40	0.50	0.012	0.016	0.020
ddd			0.08			0.003

Figure 40. QFN16 3 x 3 mm (pitch 0.5 mm) footprint recommendation



4.5 TSSOP14 package information

Figure 41. TSSOP14 package outline

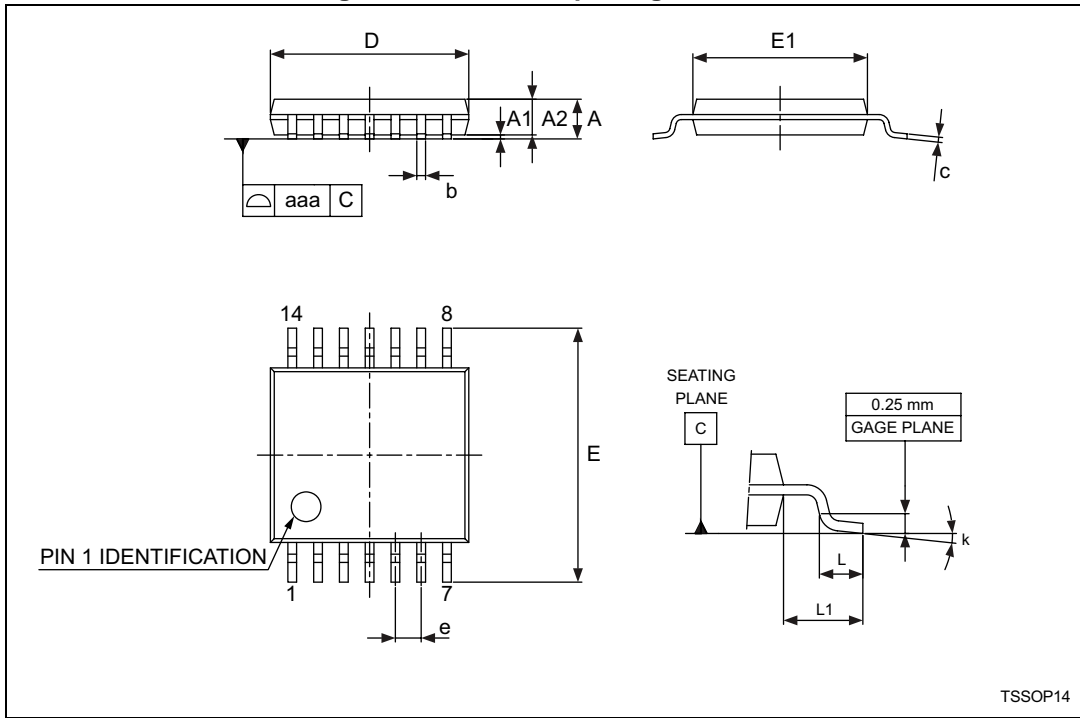

Table 11. TSSOP14 package mechanical data

Symbol	Dimensions					
	Millimeters			Inches		
	Min.	Typ.	Max.	Min.	Typ.	Max.
A			1.20			0.047
A1	0.05		0.15	0.002	0.004	0.006
A2	0.80	1.00	1.05	0.031	0.039	0.041
b	0.19		0.30	0.007		0.012
c	0.09		0.20	0.004		0.0089
D	4.90	5.00	5.10	0.193	0.197	0.201
E	6.20	6.40	6.60	0.244	0.252	0.260
E1	4.30	4.40	4.50	0.169	0.173	0.176
e		0.65			0.0256	
L	0.45	0.60	0.75	0.018	0.024	0.030
L1		1.00			0.039	
k	0°		8°	0°		8°
aaa			0.10			0.004

5 Revision history

Table 12. Document revision history

Date	Revision	Changes
18-Jan-2013	1	Initial release.
02-May-2013	2	<p>Added TS884 device to header, <i>Description</i>, and <i>Table 1: Device summary</i>.</p> <p>Updated title (added “quad” comparator).</p> <p>Updated <i>Features</i> and <i>Table 2</i> (ESD tolerance: “6 kV” HBM replaced by “8 kV” HBM).</p> <p>Updated <i>Description</i> in accordance with added TS884 device.</p> <p>Added SO14, TSSOP14 and QFN16 3 x 3 mm package to <i>Features</i>, figure on page 1, <i>Section 4: Package information</i>. and <i>Table 1: Device summary</i>.</p> <p>Moved <i>Figure 1: Pin connections TS882 (top view)</i> to page 3.</p> <p>Added <i>Figure 2: Pin connections TS884 (top view)</i>.</p> <p>Updated <i>Table 2: Absolute maximum ratings</i> (added TS884 device R_{THJA} values).</p> <p>Minor corrections throughout document.</p>
14-Jul-2014	3	Updated <i>Table 1: Device summary on page 1</i>

Please Read Carefully:

Information in this document is provided solely in connection with ST products. STMicroelectronics NV and its subsidiaries ("ST") reserve the right to make changes, corrections, modifications or improvements, to this document, and the products and services described herein at any time, without notice.

All ST products are sold pursuant to ST's terms and conditions of sale.

Purchasers are solely responsible for the choice, selection and use of the ST products and services described herein, and ST assumes no liability whatsoever relating to the choice, selection or use of the ST products and services described herein.

No license, express or implied, by estoppel or otherwise, to any intellectual property rights is granted under this document. If any part of this document refers to any third party products or services it shall not be deemed a license grant by ST for the use of such third party products or services, or any intellectual property contained therein or considered as a warranty covering the use in any manner whatsoever of such third party products or services or any intellectual property contained therein.

UNLESS OTHERWISE SET FORTH IN ST'S TERMS AND CONDITIONS OF SALE ST DISCLAIMS ANY EXPRESS OR IMPLIED WARRANTY WITH RESPECT TO THE USE AND/OR SALE OF ST PRODUCTS INCLUDING WITHOUT LIMITATION IMPLIED WARRANTIES OF MERCHANTABILITY, FITNESS FOR A PARTICULAR PURPOSE (AND THEIR EQUIVALENTS UNDER THE LAWS OF ANY JURISDICTION), OR INFRINGEMENT OF ANY PATENT, COPYRIGHT OR OTHER INTELLECTUAL PROPERTY RIGHT.

ST PRODUCTS ARE NOT DESIGNED OR AUTHORIZED FOR USE IN: (A) SAFETY CRITICAL APPLICATIONS SUCH AS LIFE SUPPORTING, ACTIVE IMPLANTED DEVICES OR SYSTEMS WITH PRODUCT FUNCTIONAL SAFETY REQUIREMENTS; (B) AERONAUTIC APPLICATIONS; (C) AUTOMOTIVE APPLICATIONS OR ENVIRONMENTS, AND/OR (D) AEROSPACE APPLICATIONS OR ENVIRONMENTS. WHERE ST PRODUCTS ARE NOT DESIGNED FOR SUCH USE, THE PURCHASER SHALL USE PRODUCTS AT PURCHASER'S SOLE RISK, EVEN IF ST HAS BEEN INFORMED IN WRITING OF SUCH USAGE, UNLESS A PRODUCT IS EXPRESSLY DESIGNATED BY ST AS BEING INTENDED FOR "AUTOMOTIVE, AUTOMOTIVE SAFETY OR MEDICAL" INDUSTRY DOMAINS ACCORDING TO ST PRODUCT DESIGN SPECIFICATIONS. PRODUCTS FORMALLY ESCC, QML OR JAN QUALIFIED ARE DEEMED SUITABLE FOR USE IN AEROSPACE BY THE CORRESPONDING GOVERNMENTAL AGENCY.

Resale of ST products with provisions different from the statements and/or technical features set forth in this document shall immediately void any warranty granted by ST for the ST product or service described herein and shall not create or extend in any manner whatsoever, any liability of ST.

ST and the ST logo are trademarks or registered trademarks of ST in various countries.

Information in this document supersedes and replaces all information previously supplied.

The ST logo is a registered trademark of STMicroelectronics. All other names are the property of their respective owners.

© 2014 STMicroelectronics - All rights reserved

STMicroelectronics group of companies

Australia - Belgium - Brazil - Canada - China - Czech Republic - Finland - France - Germany - Hong Kong - India - Israel - Italy - Japan - Malaysia - Malta - Morocco - Philippines - Singapore - Spain - Sweden - Switzerland - United Kingdom - United States of America

www.st.com