

BCX51-16-G

BCX52-16-G

BCX53-16-G

RoHS Device



Features

- Transistor PNP.
- Low voltage.
- High current.

Circuit Diagram

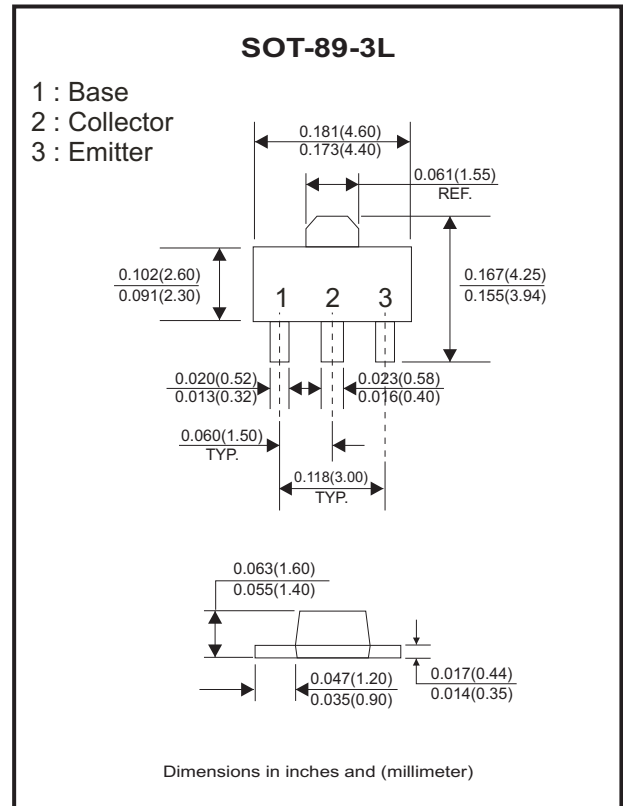
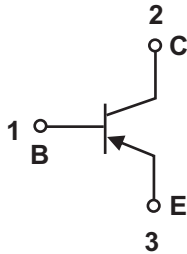

Maximum Ratings (at TA=25°C unless otherwise noted)

Parameter	Symbol	Value	Unit
Collector-Base voltage	V _{CBO}	BCX51	-45
		BCX52	-60
		BCX53	-100
Collector-Emitter voltage	V _{CEO}	BCX51	-45
		BCX52	-60
		BCX53	-80
Emitter-Base voltage	V _{EBO}	-5	V
Continuous current	I _C	-1	A
Collector power dissipation	P _C	500	mW
Thermal resistance from junction to ambient	R _{θJA}	250	°C/W
Junction temperature range	T _J	-40~+150	°C
Storage temperature range	T _{stg}	-55~+150	°C

Company reserves the right to improve product design, functions and reliability without notice.

REV:A

Electrical Characteristics (at TA=25°C unless otherwise noted)

Parameter	Symbol	Conditions	Min	Typ	Max	Unit	
Collector-base breakdown voltage	V _{(BR)CBO}	I _c = -100μA, I _E = 0	BCX51	-45			V
			BCX52	-60			
			BCX53	-100			
Collector-emitter breakdown voltage	V _{(BR)CEO*}	I _c = -10mA, I _B = 0	BCX51	-45			V
			BCX52	-60			
			BCX53	-80			
Emitter-base breakdown voltage	V _{(BR)EBO}	I _E = -100μA, I _C = 0	-5			V	
Collector cut-off current	I _{CBO}	V _{CB} = -30V, I _E = 0			-0.1	μA	
Emitter cut-off current	I _{EBO}	V _{EB} = -5V, I _C = 0			-0.1	μA	
DC current gain	h _{FE(1)*}	V _{CE} = -2V, I _C = -5mA	63				
	h _{FE(2)*}	V _{CE} = -2V, I _C = -150mA	63		250		
	h _{FE(3)*}	V _{CE} = -2V, I _C = -0.5A	40				
Collector-emitter saturation voltage	V _{CE(sat)*}	I _C = -0.5A, I _B = -50mA			-0.5	V	
Base-emitter saturation voltage	V _{BE*}	V _{CE} = -2V, I _C = -0.5A			-1	V	
Transition frequency	f _T	V _{CE} = -5V, I _C = -10mA f = 100MHz		50		MHz	

* Pulse test

Classification Of h_{FE(2)}

Part No.	BCX51-16-G	BCX52-16-G	BCX53-16-G
Range	100-250	100-250	100-250

RATING AND CHARACTERISTIC CURVES (BCX51-16-G, BCX52-16-G, BCX53-16-G)

Fig.1 - Static Characteristic

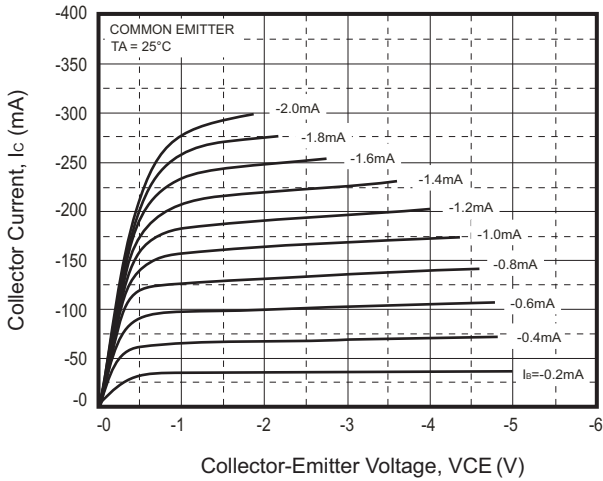

Fig.2 - $h_{FE} - I_c$

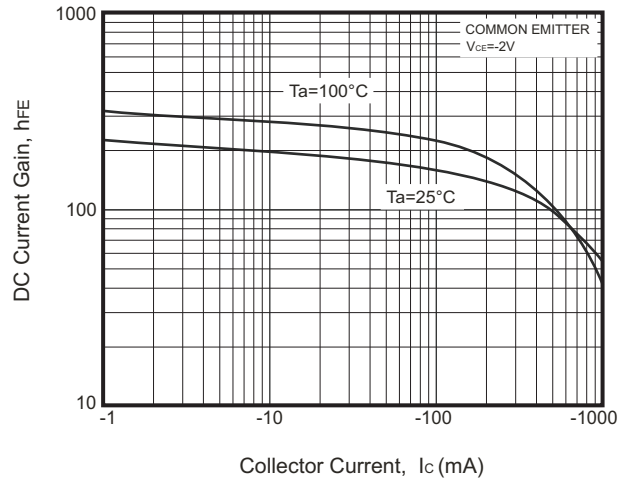

Fig.3 - $V_{CEsat} - I_c$

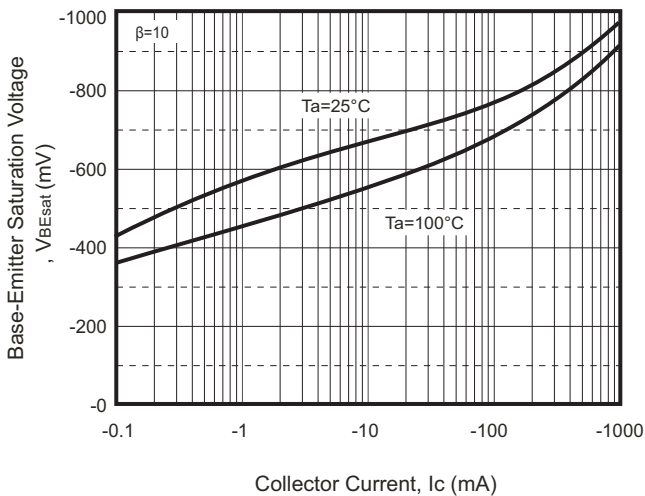

Fig.4 - $V_{CEsat} - I_c$

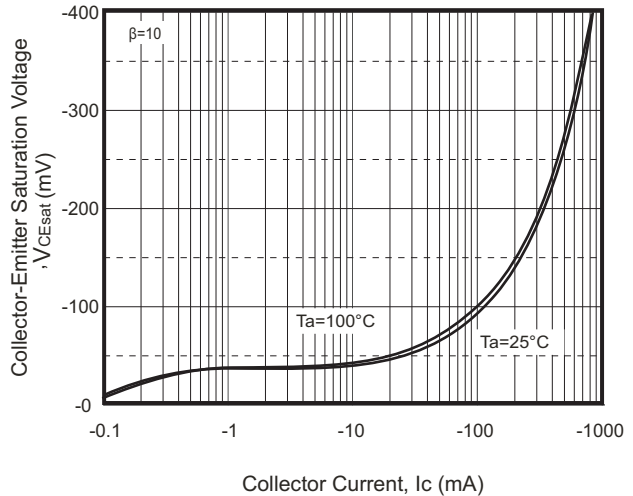

Fig.5 - $f_T - I_c$

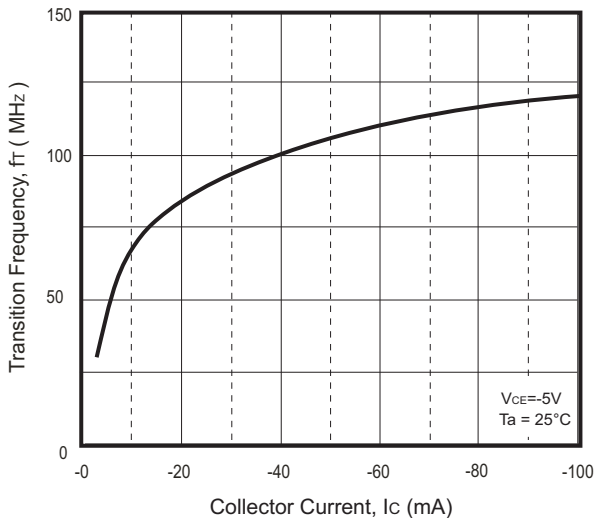
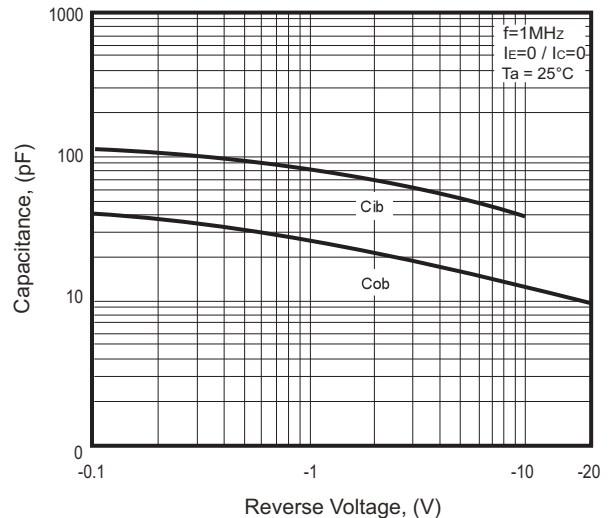

Fig.6 - $C_{ob}/C_{ib} - V_{CB}/V_{EB}$



STATIC AND CHARACTERISTIC CURVES (BCX51-16G, BCX52-16-G, BCX53-16-G)

Fig.7 - I_c — V_{BE}

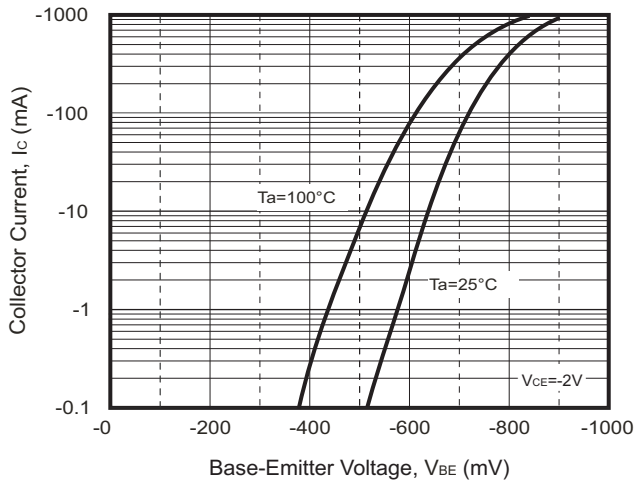
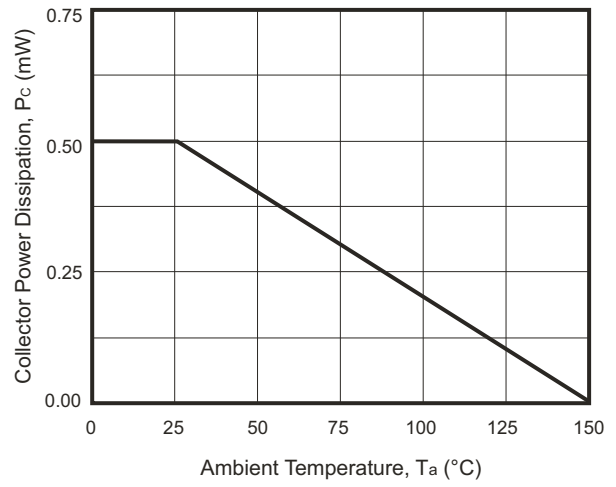
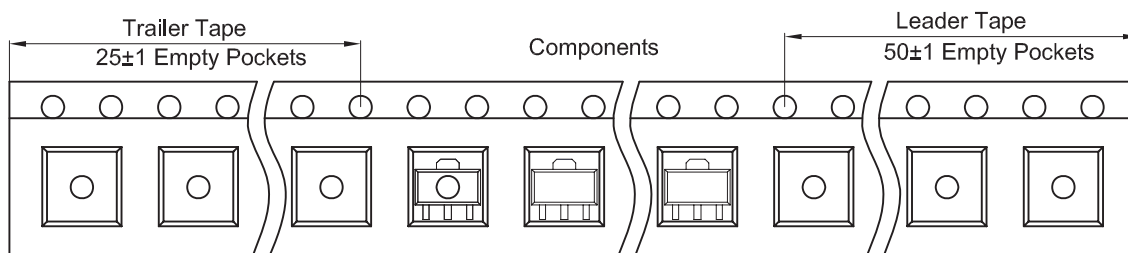
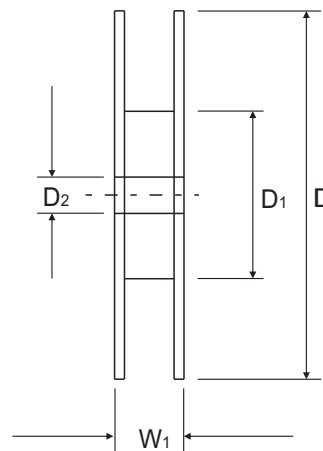
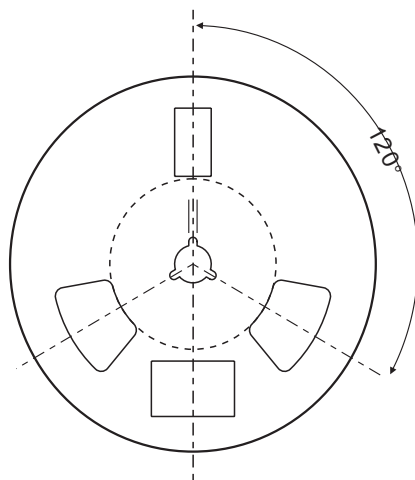
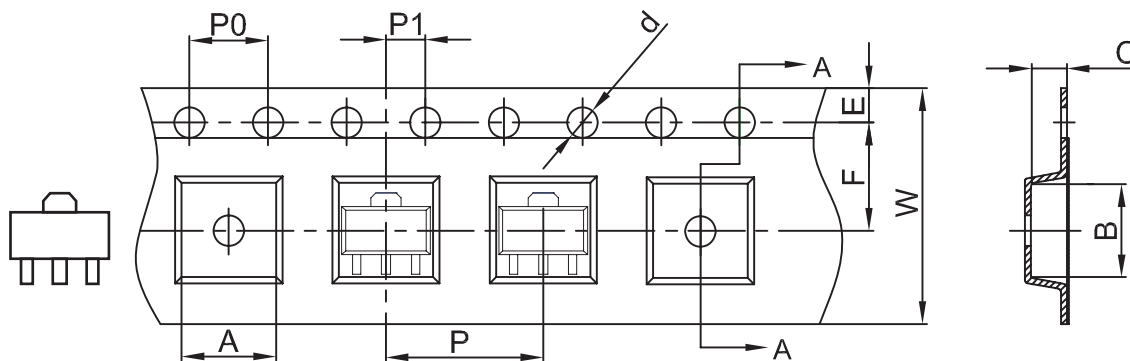

Fig.8 - P_c — T_a



Reel Taping Specification



SOT-89-3L	SYMBOL	A	B	C	d	D	D1	D2
	(mm)	4.85 ± 0.10	4.45 ± 0.10	1.85 ± 0.10	1.50 ± 0.10	180 ± 2.00	60.00 ± 1.00	R32.00 ± 1.00
	(inch)	0.191 ± 0.004	0.175 ± 0.004	0.073 ± 0.004	0.059 ± 0.004	7.087 ± 0.079	2.362 ± 0.039	1.260 ± 0.039

SOT-89-3L	SYMBOL	E	F	P	P0	P1	W	W1
	(mm)	1.75 ± 0.10	5.50 ± 0.10	8.00 ± 0.10	4.00 ± 0.10	2.00 ± 0.10	12.00 + 0.30 / - 0.10	16.50 ± 1.00
	(inch)	0.069 ± 0.004	0.217 ± 0.004	0.315 ± 0.004	0.158 ± 0.004	0.079 ± 0.004	0.472 + 0.012 / - 0.004	0.650 ± 0.039

Marking Code

Part Number	Marking Code
BCX51-16-G	AD
BCX52-16-G	AM
BCX53-16-G	AL

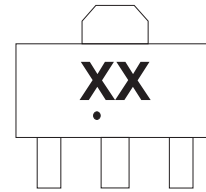

xx = Product type marking code

Suggested PAD Layout

SIZE	SOT-89-3L	
	(mm)	(inch)
A	2.60	0.102
B	1.40	0.055
C	4.40	0.173
D	3.20	0.126
E	1.90	0.075
F	1.10	0.043
G	0.52	0.020
H	0.58	0.023
I	1.50	0.059

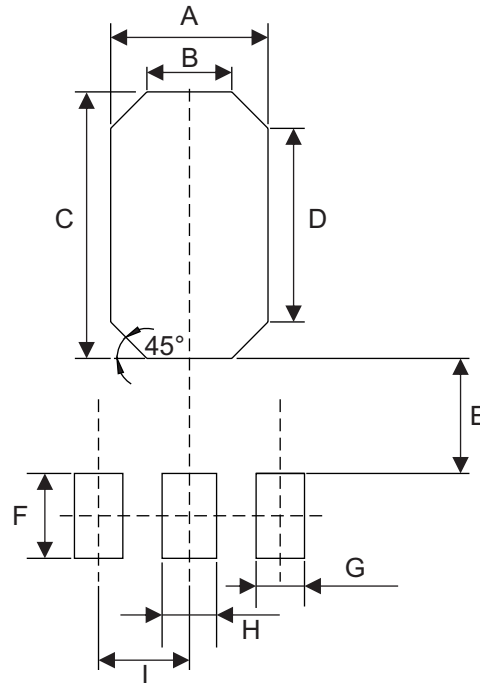

Standard Packaging

Case Type	REEL PACK	
	REEL (pcs)	Reel Size (inch)
SOT-89-3L	1,000	7