

DETAILS

Product Number	CA12012_LAURA-O-PIN
Family	Laura
Type	Assembly
Color	white
Diameter	21,6 x 21,6 mm
Height	13,1 mm
Style	square
Optic Material	PMMA
Holder Material	
Fastening	tape, pin
Status	production ready
ROHS Compliant	Yes
Date Updated	6/06/2017



OPTICAL PROPERTIES

LED	Viewing	Light	Efficiency	cd/lm	Connector
	Angle	Beam			
XP-E	40+13 deg	Oval	91 %	4.800	-
XP-G	40+13 deg	Oval	91 %	-	-
XB-D	39+11 deg	Oval	94 %	4.810	-
XP-E2	41+10 deg	Oval	91 %	6.740	-
LUXEON Rebel	41+12 deg	Oval	90 %	5.000	-
LUXEON Z ES	40+11 deg	Oval	91 %	6.200	-
LUXEON H50-2	sim: 13+61	Oval	sim: 81 %	sim: 2.700	-
LUXEON Rebel ES	41+14 deg	Oval	90 %	4.600	-
NCSxx19B	41+13 deg	Oval	90 %	5.100	-
SFH 4715S	41+14 deg	Oval	sim: 80 %	-	-
Oslon Square PC	40+12 deg	Oval	88 %	5.100	-
Oslon Square EC	39+14 deg	Oval	87 %	3.820	-
Oslon SSL 80	40+12 deg	Oval	86 %	4.530	-
Oslon SSL 150	36+10 deg	Oval	86 %	4.440	-
SFH 4725S	40+14 deg	Oval	-	-	-
Z5	40+12 deg	Oval	-	-	-

Relative intensity of CA12012_LAURA-O-PIN_(XP-E2)

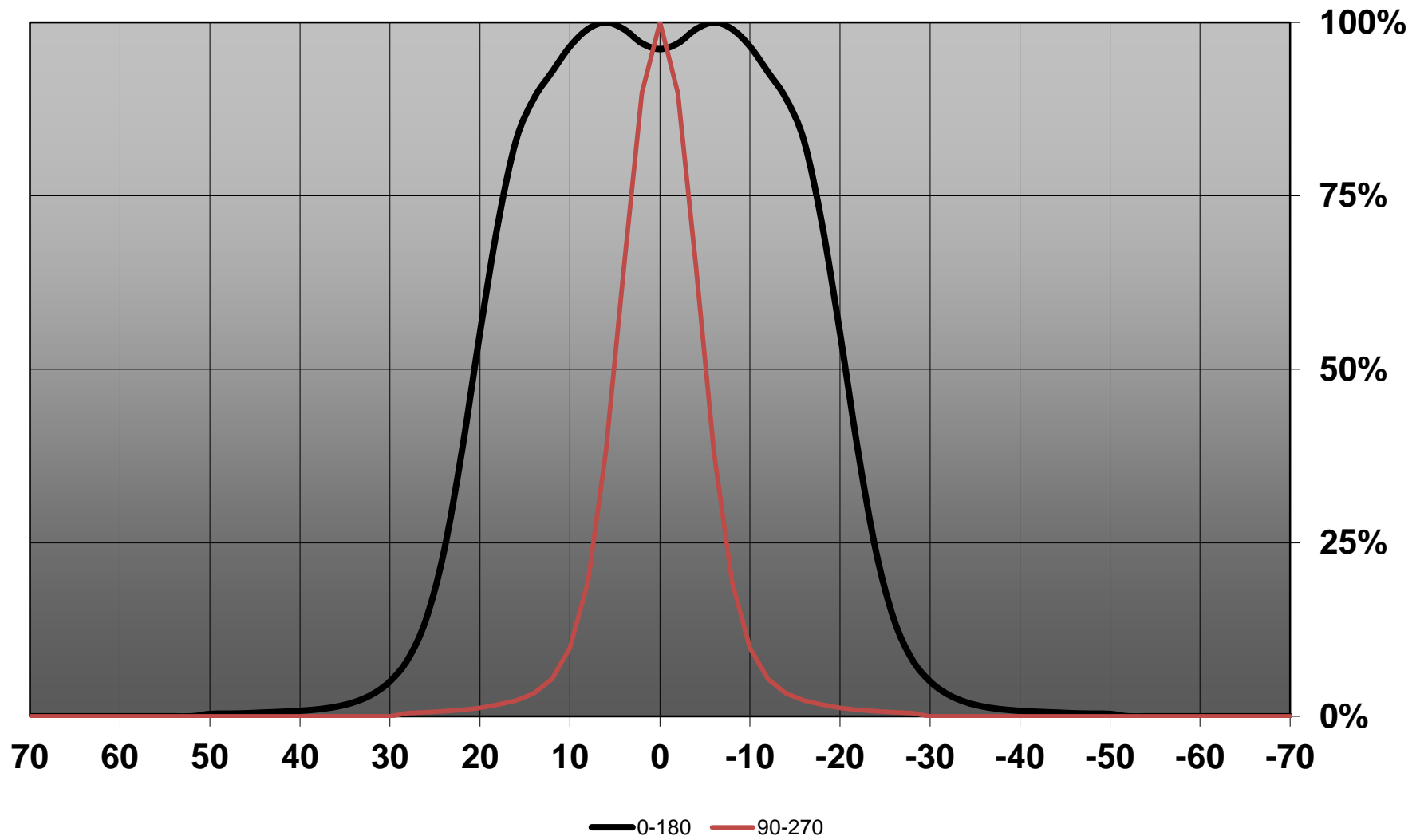

Relative intensity of CA12012_LAURA-O-PIN_(Luxeon Z ES)

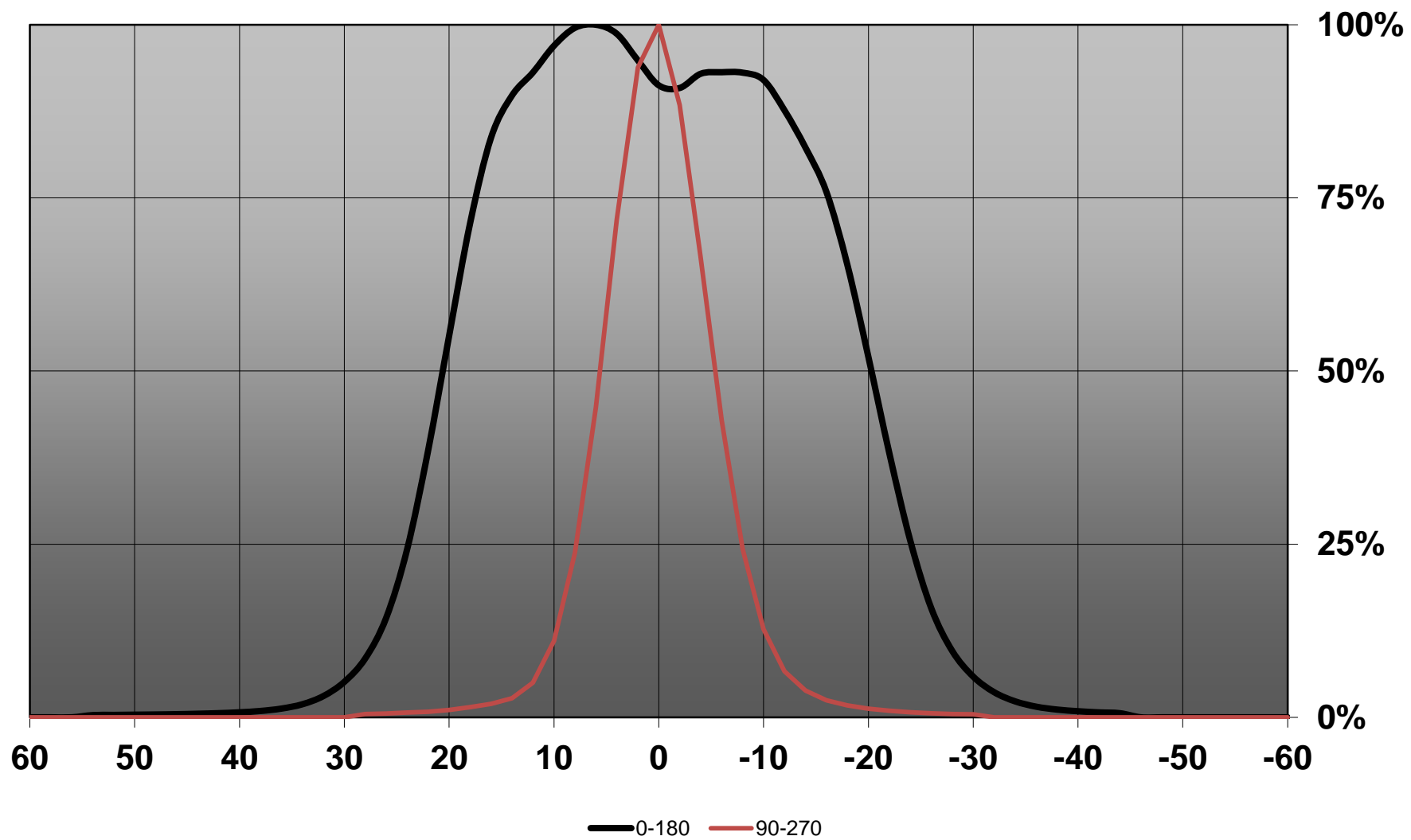

Relative intensity of CA12012_LAURA-O-PIN_(Oslon_Square_PC)

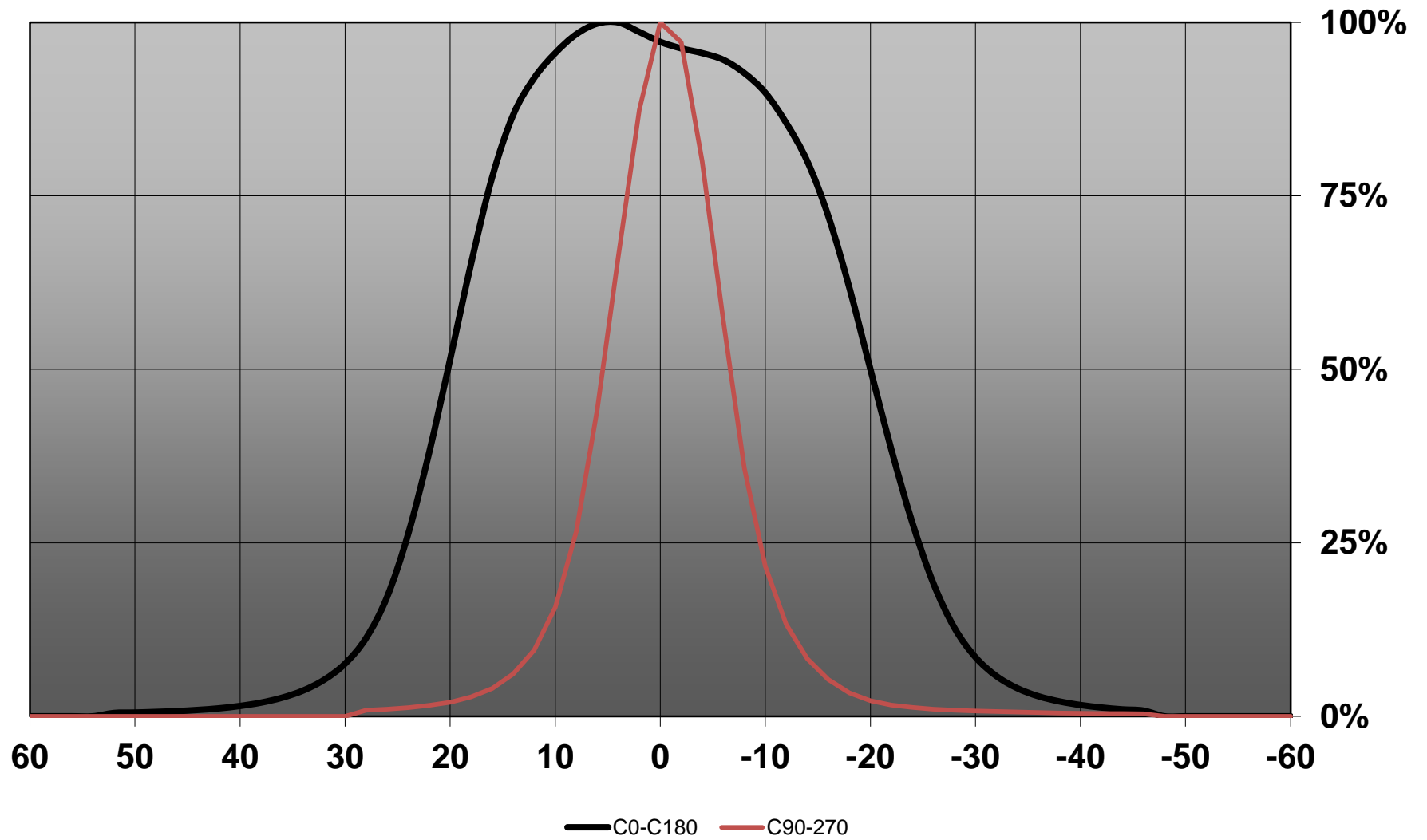

Relative intensity of CA12012_LAURA-O-PIN_(SFH4725S)

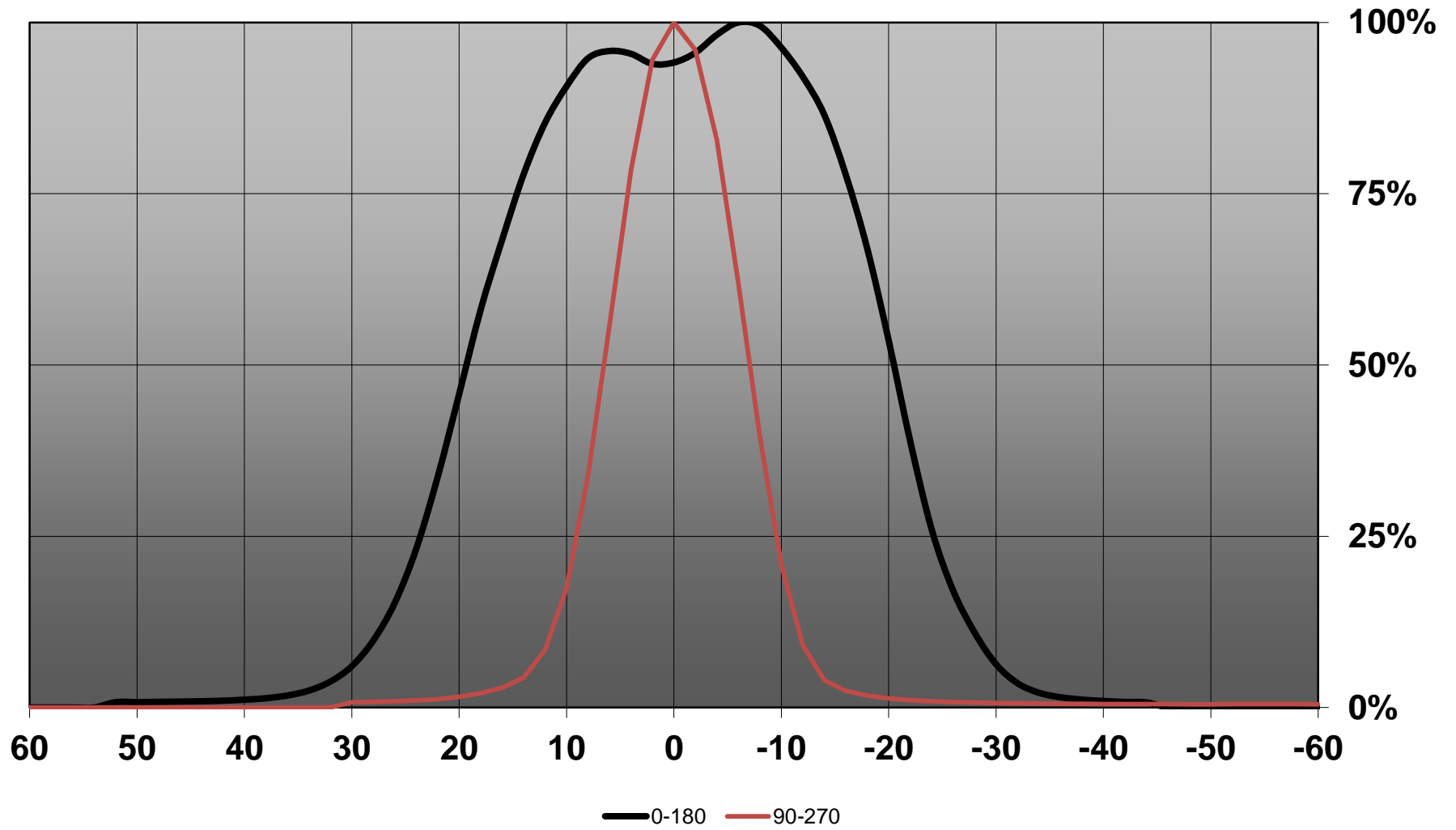

D

C

B

A

4

4

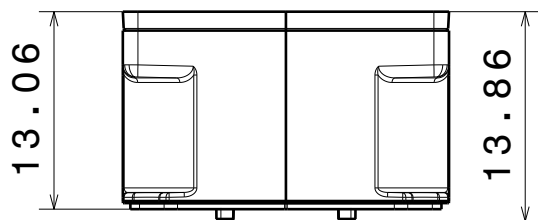

Front view

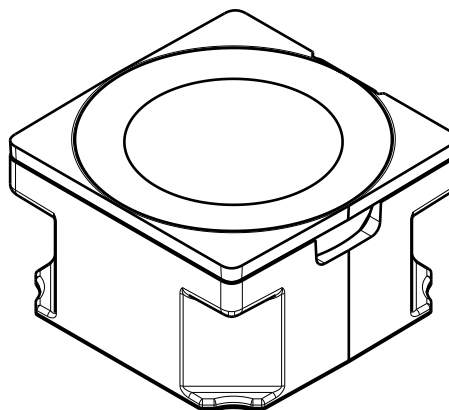
Isometric view
Scale: 2:1

3

3

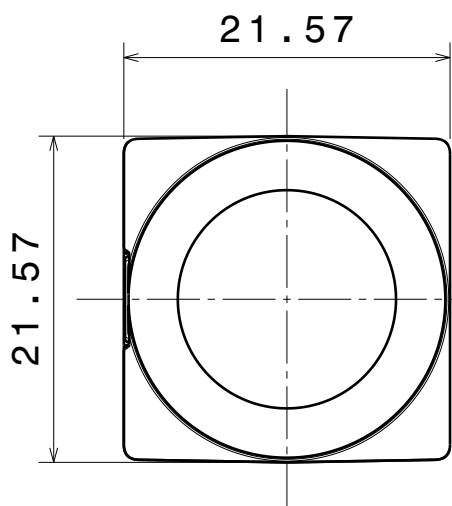

Top view

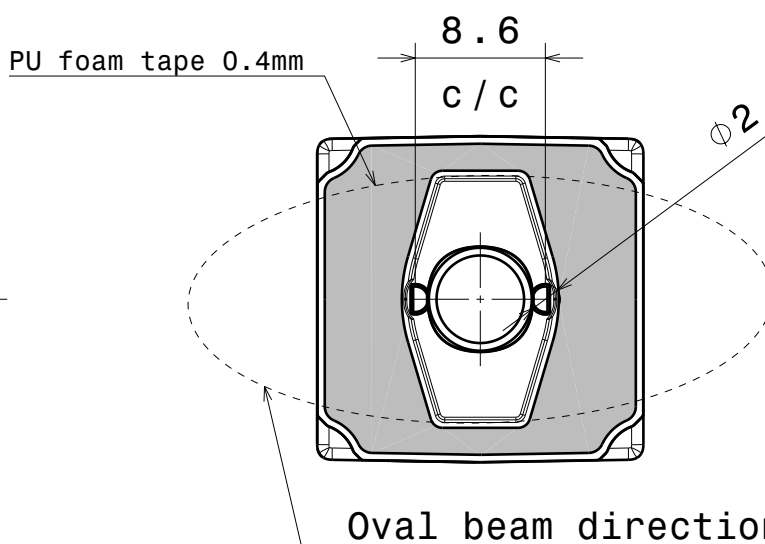

Bottom view

2

2

INDEX	PART NO	DESCRIPTION	MATERIAL	COLOUR
1	-	Laura-mech	PMMA	
3	C11835	LAURA-PIN-XP-HLD-WHT	PC	white

Tolerances if not otherwise shown
According to DIN ISO 2768-1
Linear measures:
Up to 30mm class M, otherwise class C.
According to DIN ISO 2768-2
Form and position: class L

LEDiL

Ledil Oy
Salorankatu 10
FIN 24240 SALO
Finland

THIRD ANGLE PROJECTION:

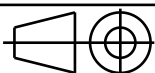

DRAWING TITLE

LAURA-XP-PIN-WHT assembly

This drawing is the property
of LEDiL Oy. It may not be
reproduced, copied or
communicated without a written
agreement with LEDiL Oy.

SIZE PART NUMBER

A4

-

SCALE

2:1

WEIGHT

9 g

SHEET

1/1

D

A

1

1

Ledil Oy CA11365-Laura-O-XP-tape CA11365-Laura-O-XP-tape / LDC (Linear)

Luminaire: Ledil Oy CA11365-Laura-O-XP-tape CA11365-Laura-O-XP-tape
Lamps: 1 x Cree XP-E white

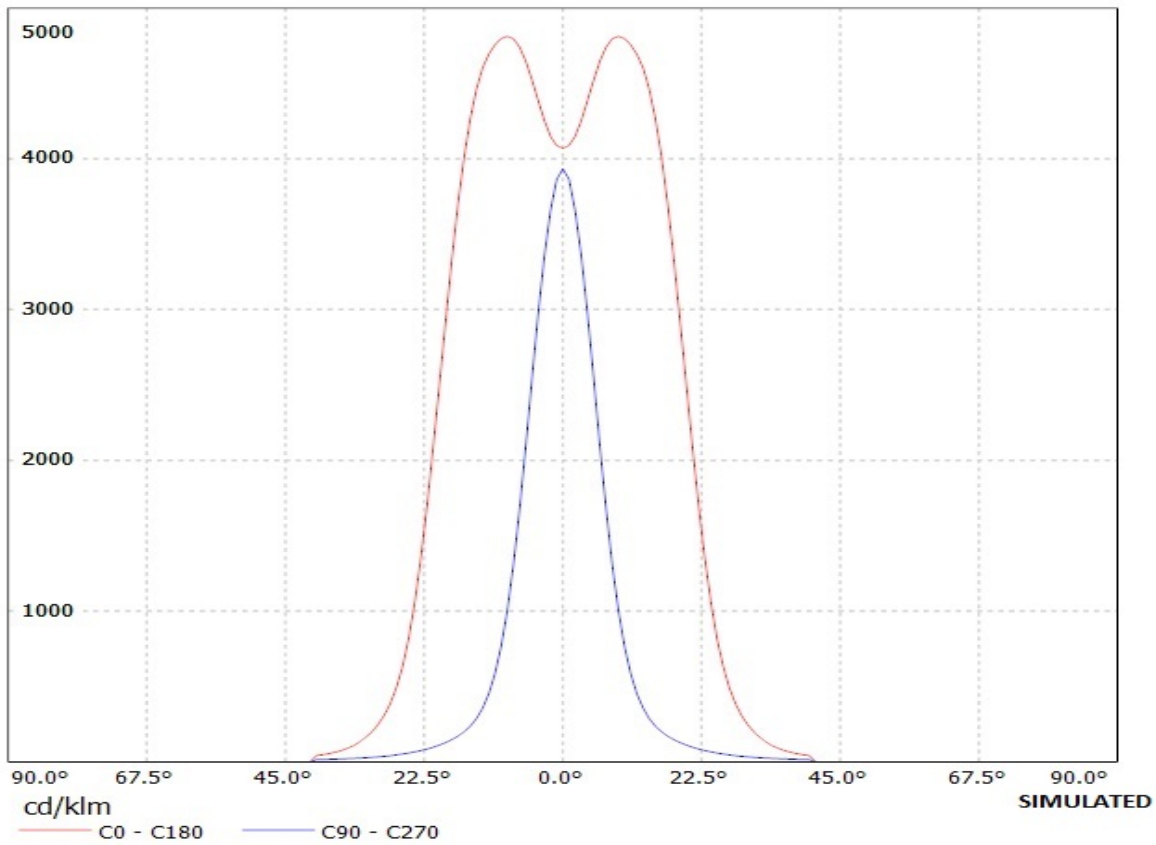

Ledil Oy CA12012_Laura-O-Pin-XP-G-tape / LDC (Linear)

Luminaire: Ledil Oy CA12012_Laura-O-Pin-XP-G-tape
Lamps: 1 x Cree XP-G 63,5lm 250mA Warm

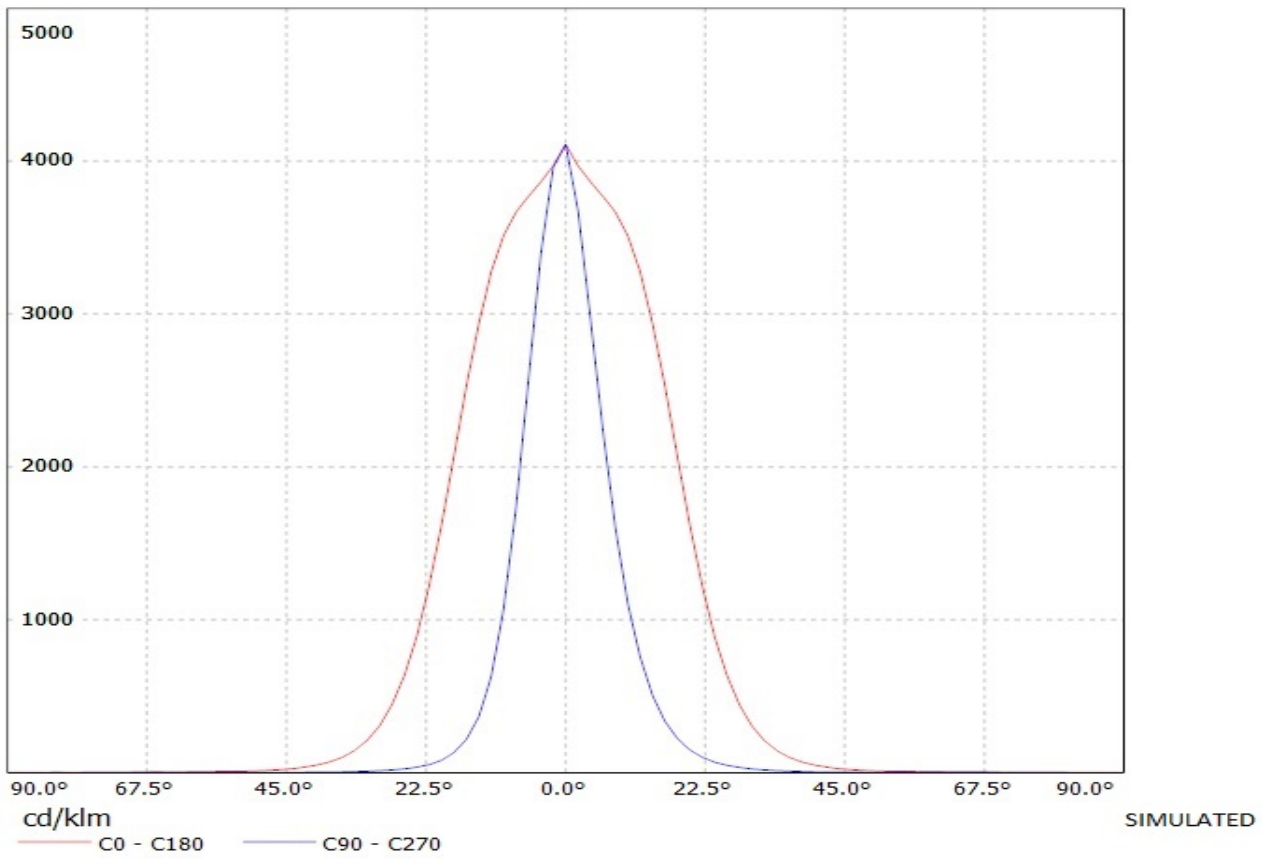

Luminaire: LEDil Oy CA12012_LAURA-O-PIN_(XP-E2)
Lamps: 1 x Cree XP-E2 (92lm @ 250mA) CCT=5500K P=0.8W I=250mA

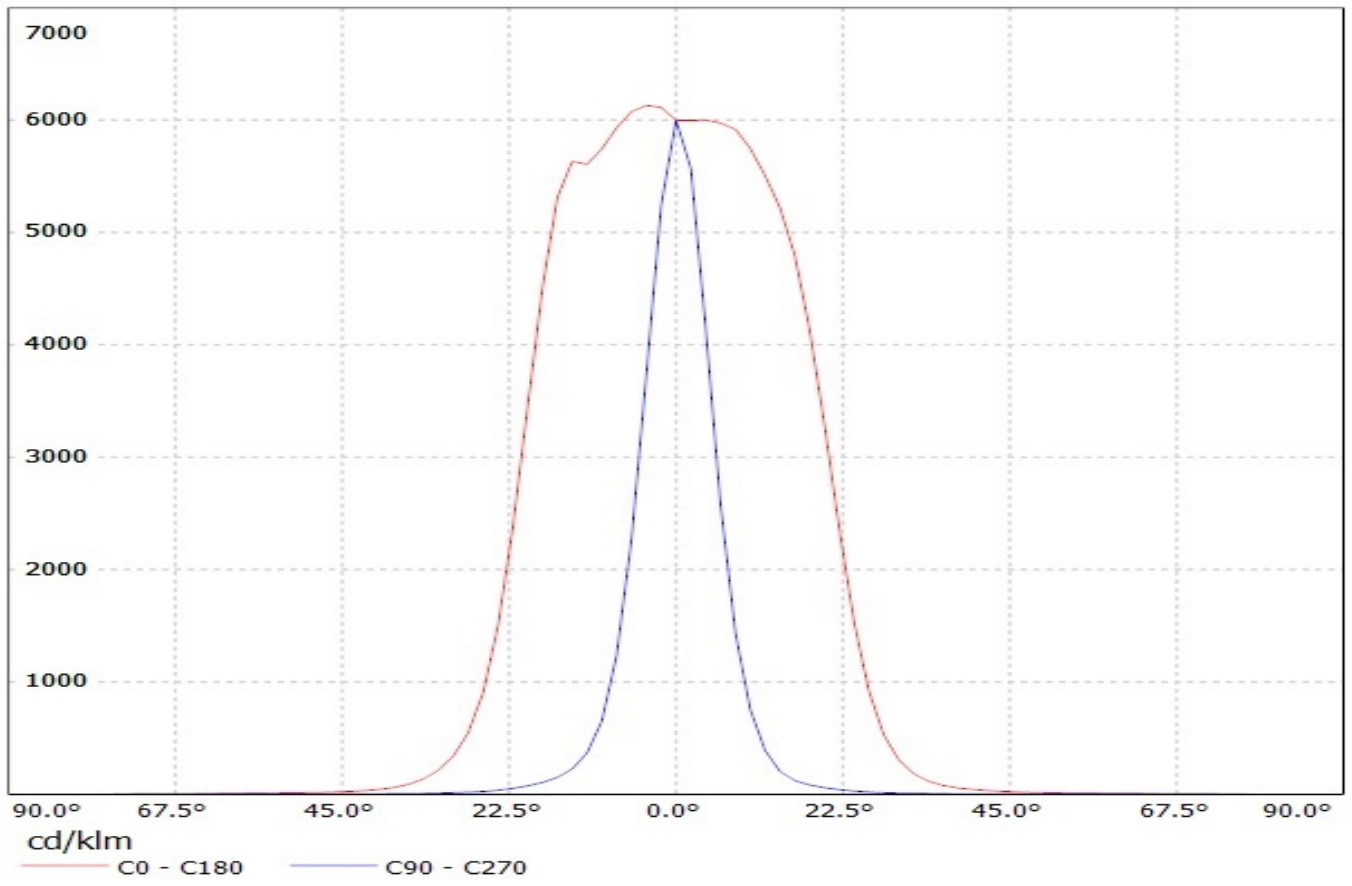

Luminaire: LEDil Oy CA12012_LAURA-O-PIN_(Luxeon_Rebel_ES) Efficiency=90%
Lamps: 1 x Philips Lumileds Luxeon Rebel ES (91.3lm @ 250mA) CCT=4100K P=0.8W I=250mA

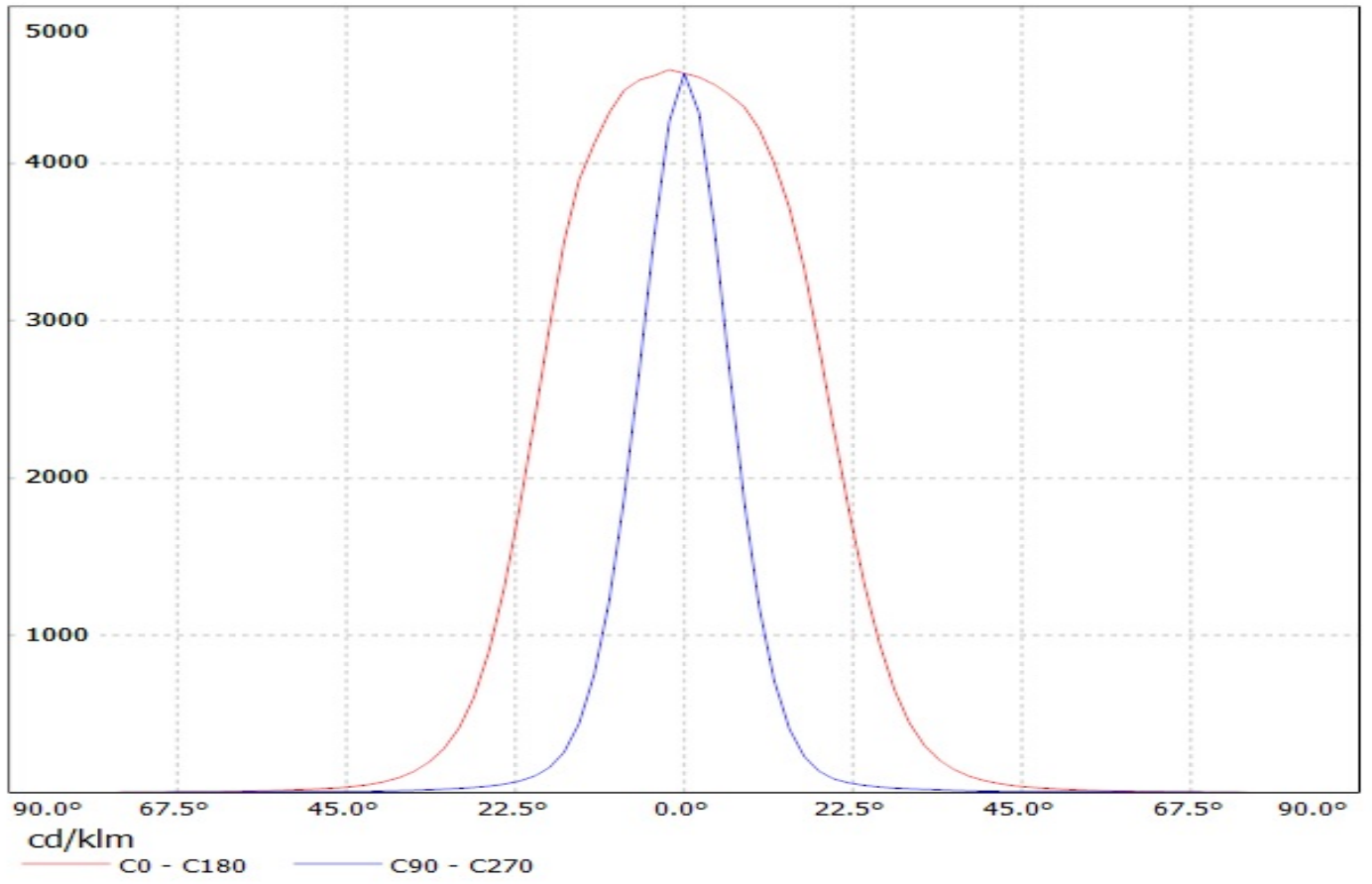

Luminaire: LEDil Oy CA12012_LAURA-O-PIN_(NCSxx19B) Efficiency=90%
Lamps: 1 x Nichia NCSxx19B (NCSL119BE) 88.5lm @ 250mA CCT=3400K P=0.8W I=250mA

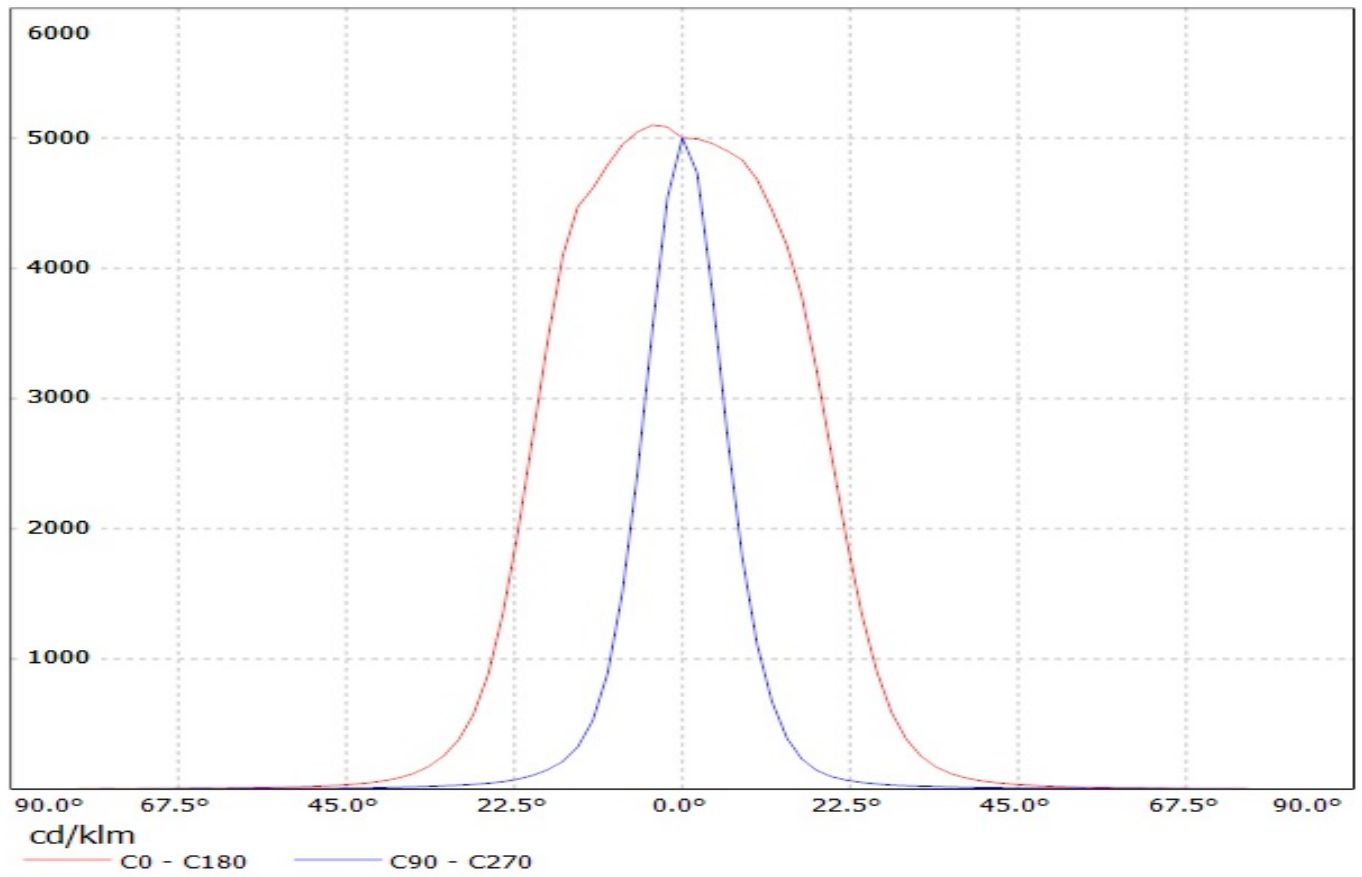

Luminaire: Ledil Oy CA12012_LAURA-O-PIN-EC (Osram Square EC 78lm @ 250mA) Efficiency=87%
Lamps: 1 x Osram Square EC 78lm @ 250mA

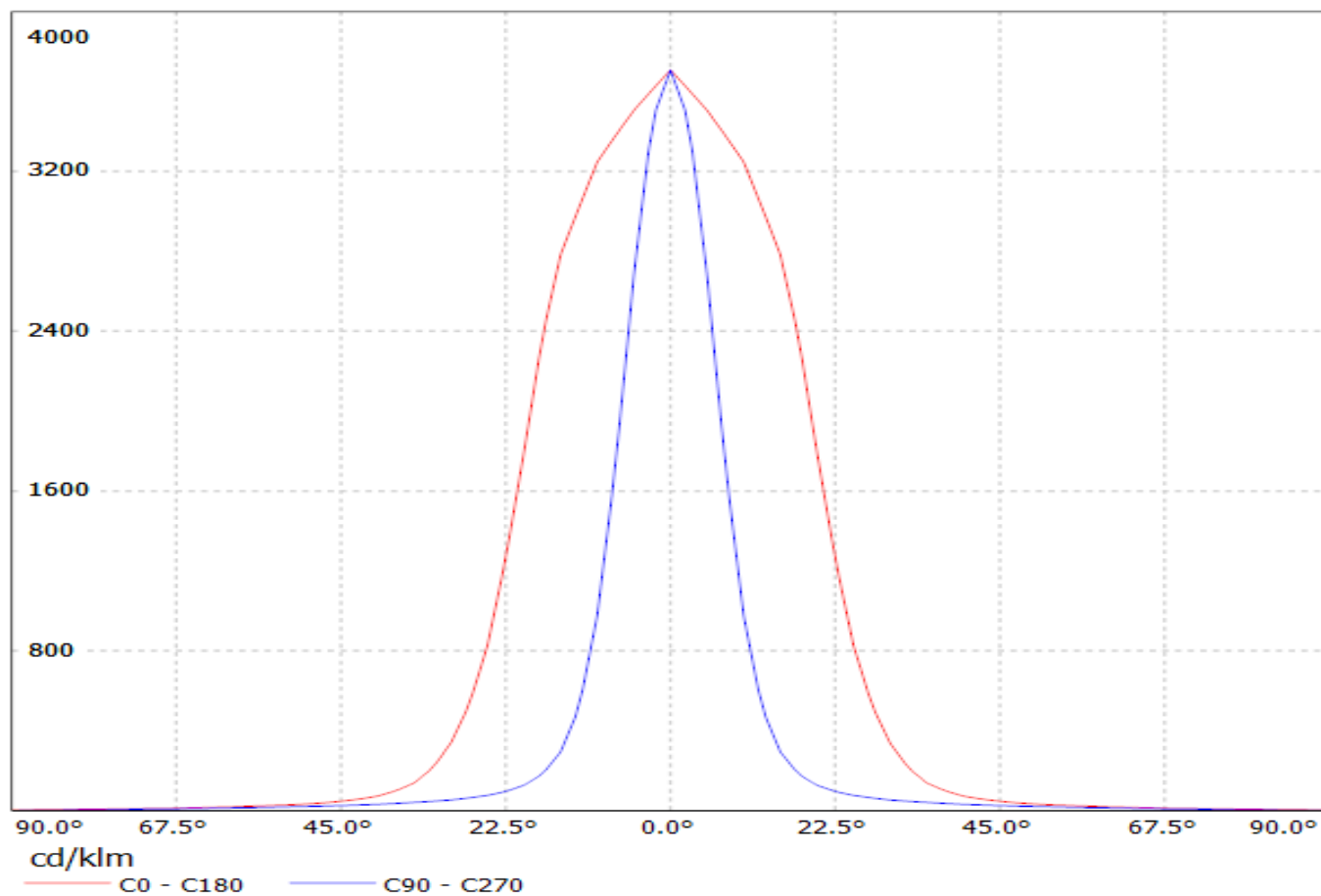

Ledil Oy CA11365-Laura-O-XP-tape CA11365-Laura-O-XP-tape / LDC (Polar)

Luminaire: Ledil Oy CA11365-Laura-O-XP-tape CA11365-Laura-O-XP-tape

Lamps: 1 x Cree XP-E white

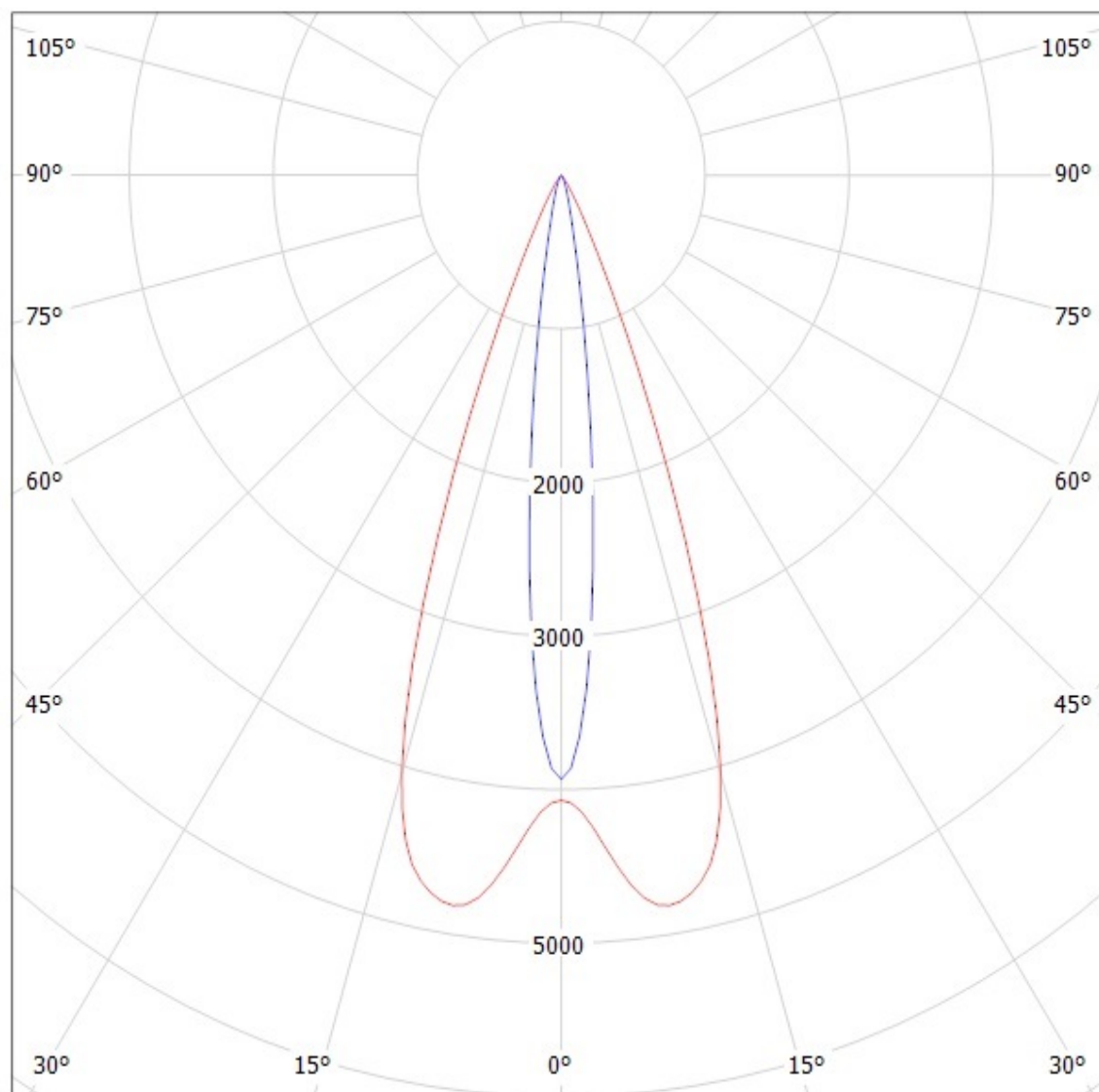

cd/klm

— C0 - C180

— C90 - C270

SIMULATED

Ledil Oy CA12012_Laura-O-Pin-XP-G-tape / LDC (Polar)

Luminaire: Ledil Oy CA12012_Laura-O-Pin-XP-G-tape

Lamps: 1 x Cree XP-G 63,5lm 250mA Warm

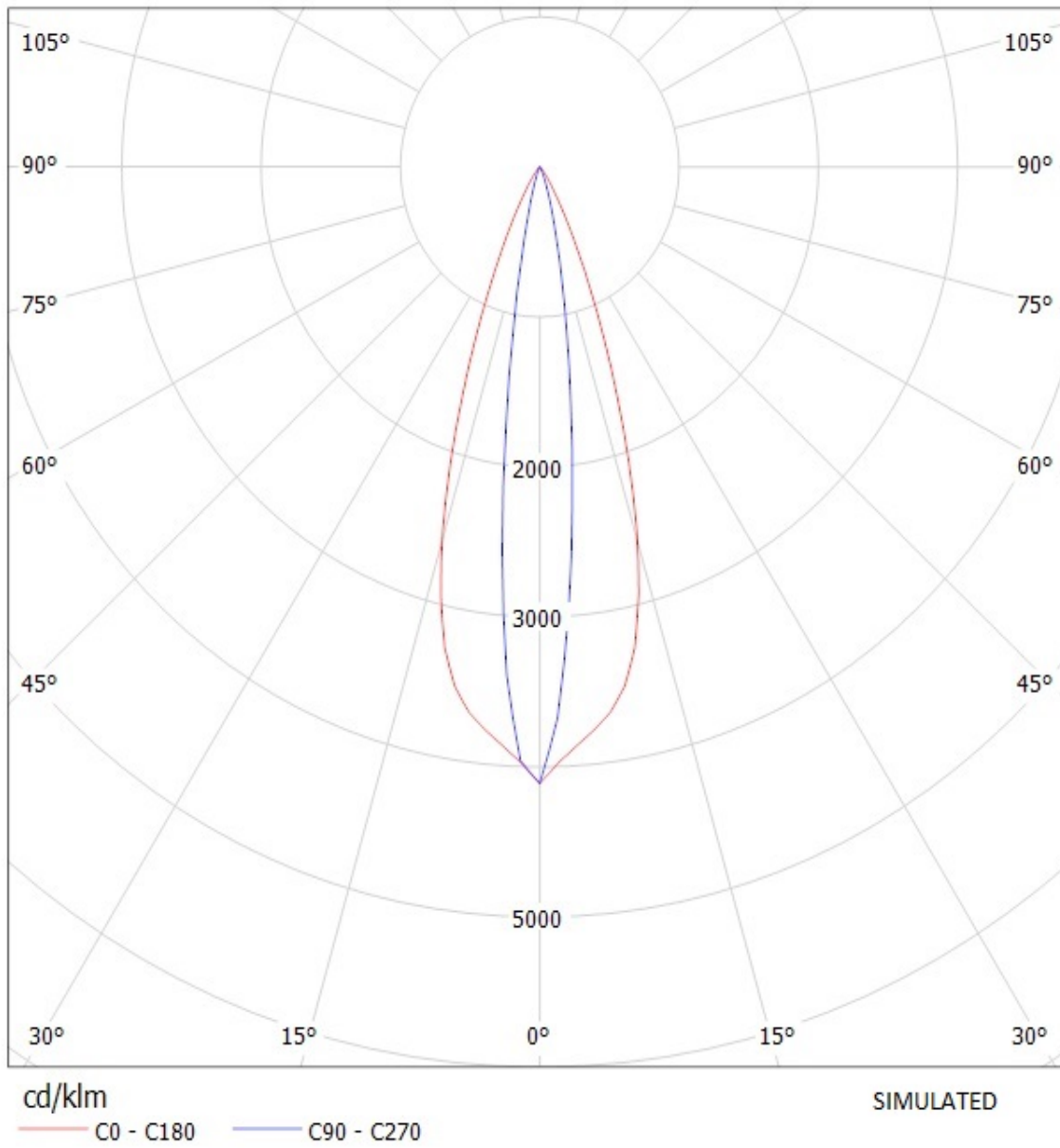

Luminaire: LEDil Oy CA12012_LAURA-O-PIN_(XP-E2)
Lamps: 1 x Cree XP-E2 (92lm @ 250mA) CCT=5500K P=0.8W I=250mA

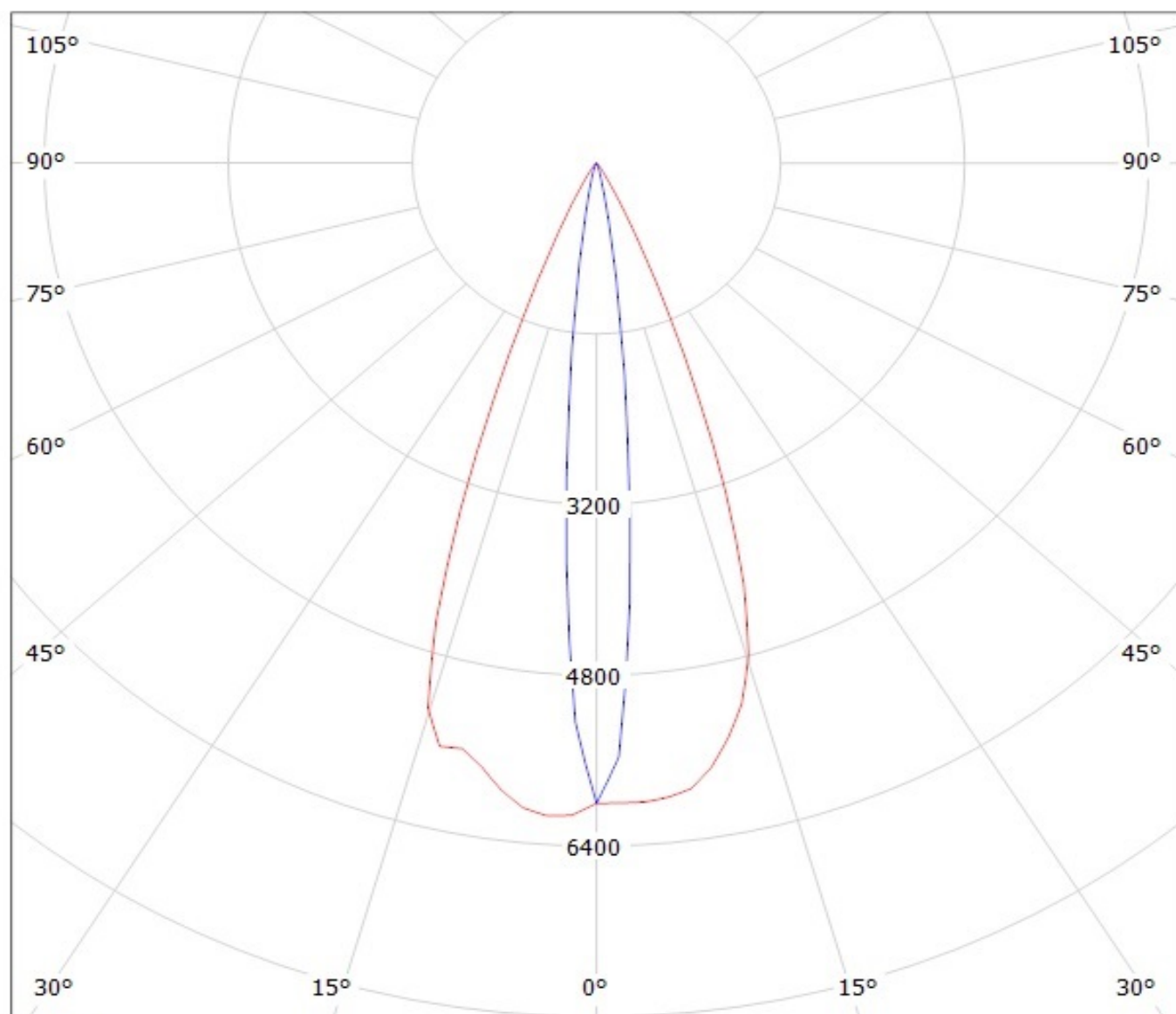

cd/klm

— C0 - C180 — C90 - C270

Luminaire: LEDil Oy CA12012_LAURA-O-PIN_(Luxeon_Rebel_ES) Efficiency=90%
Lamps: 1 x Philips Lumileds Luxeon Rebel ES (91.3lm @ 250mA) CCT=4100K P=0.8W I=250mA

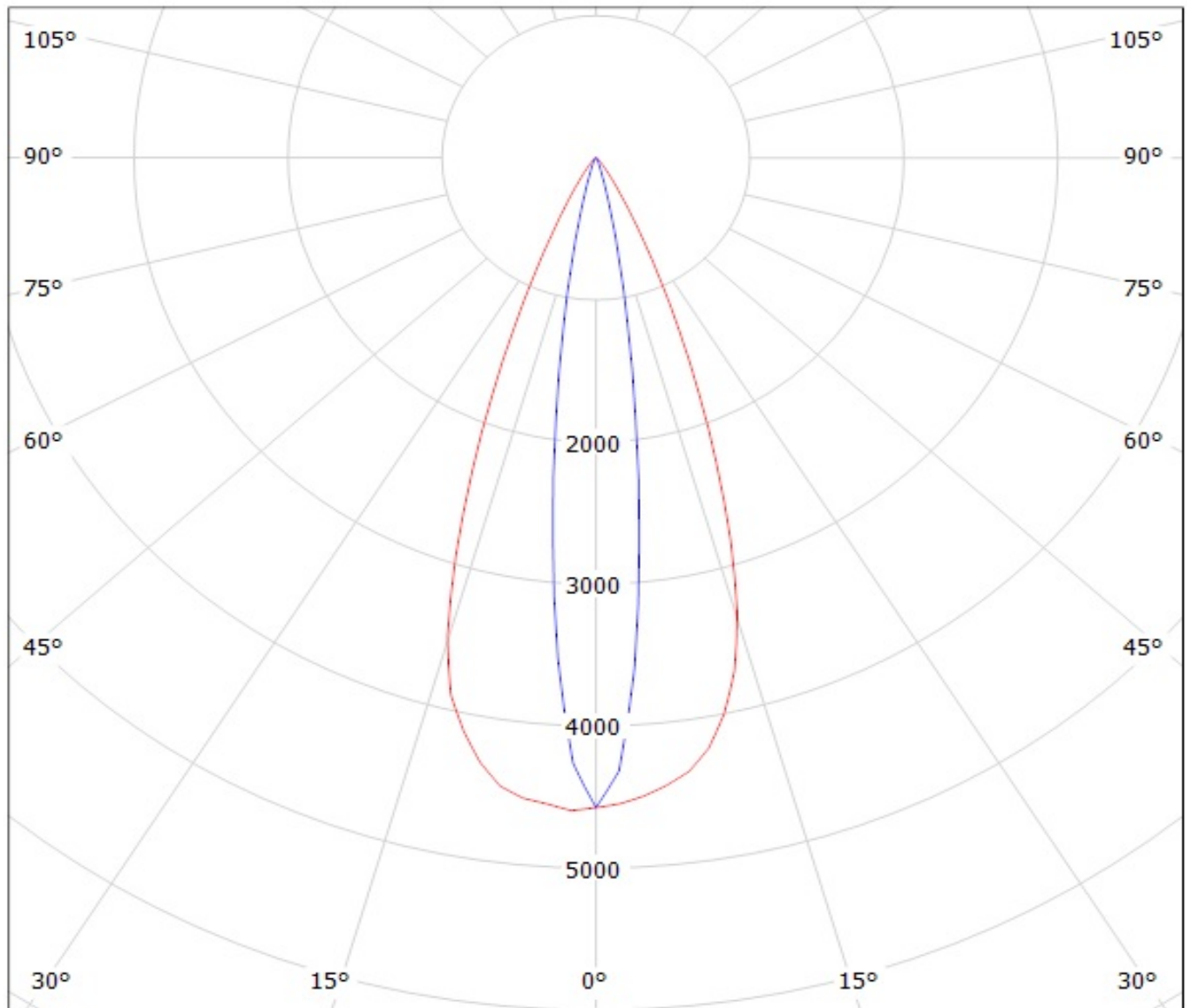

cd/klm

— C0 - C180 — C90 - C270

Luminaire: LEDil Oy CA12012_LAURA-O-PIN_(NCSxx19B) Efficiency=90%
Lamps: 1 x Nichia NCSxx19B (NCSL119BE) 88.5lm @ 250mA CCT=3400K P=0.8W I=250mA

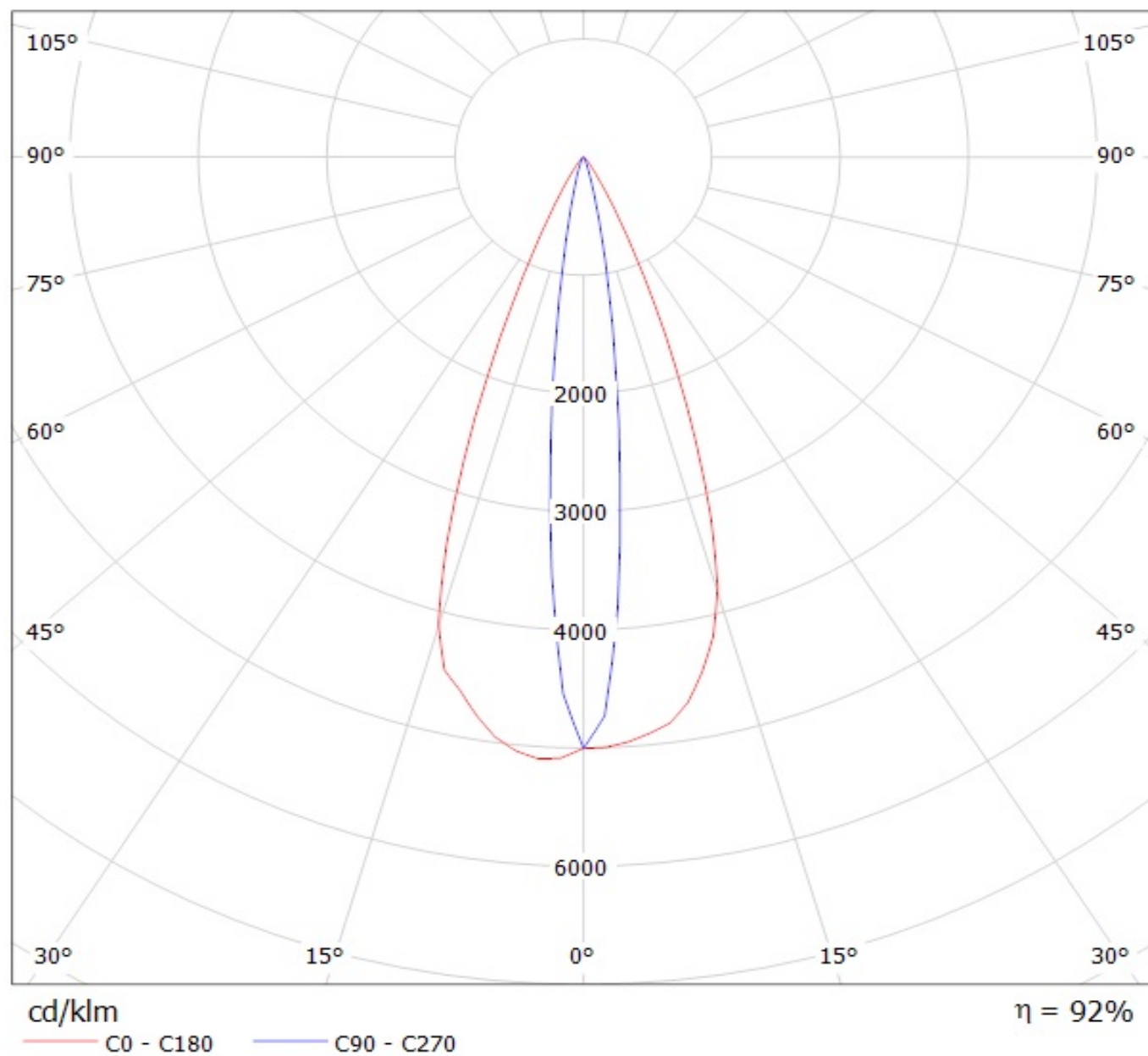

Luminaire: Ledil Oy CA12012_LAURA-O-PIN-EC (Osram Square EC 78lm @ 250mA) Efficiency=87%
Lamps: 1 x Osram Square EC 78lm @ 250mA

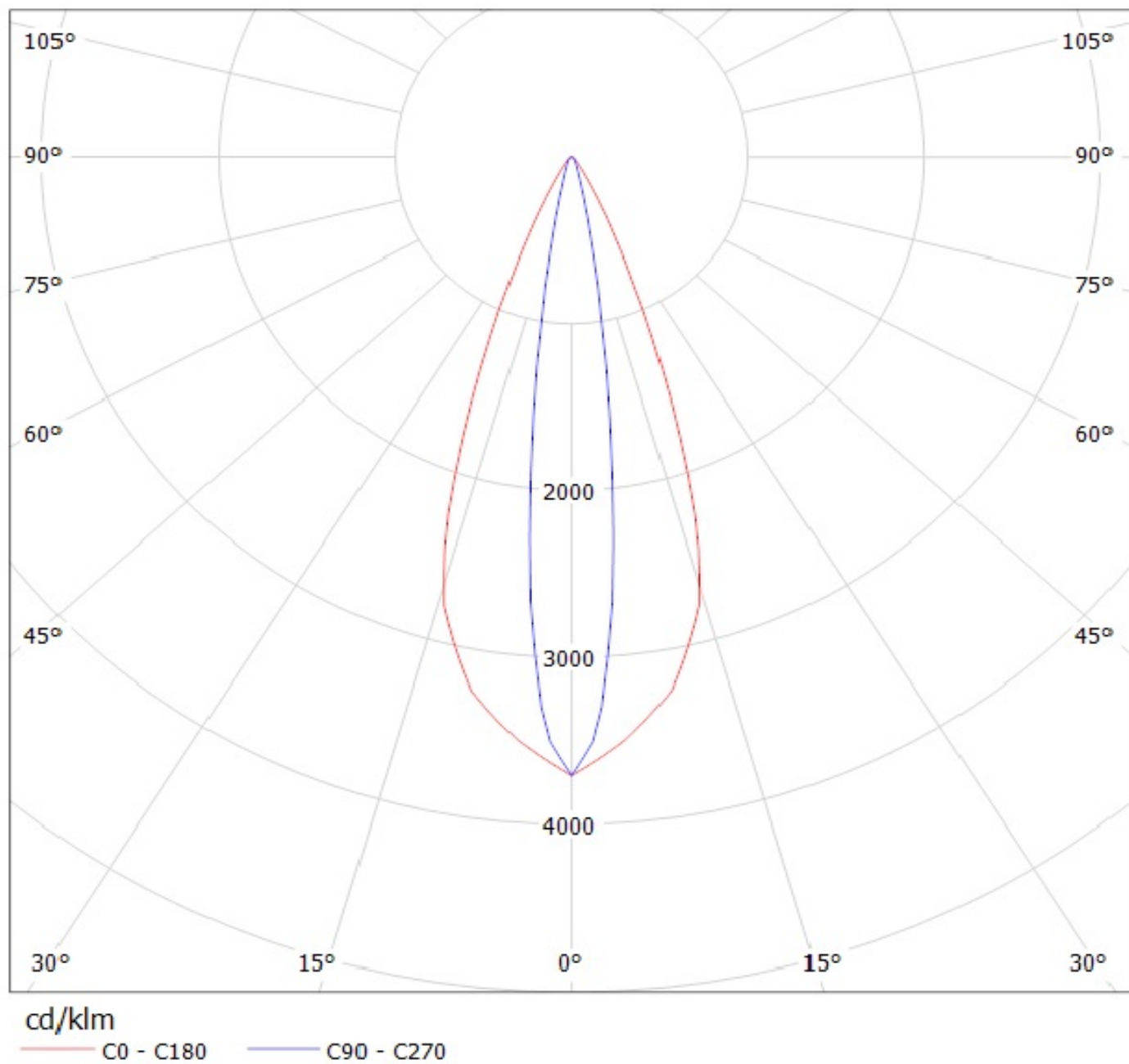

NOTE: The typical divergence will be changed by different color, chip size and chip position tolerance. The typical total divergence is the full angle measured where the luminous intensity is half of the peak value.