

# ELM832xC 20μA Low power CMOS operational amplifier

<http://www.elm-tech.com>

## ■General description

ELM832xC is a low current consumption-Typ.20μA CMOS OP-AMP provided with a wide common mode input voltage range. It has a quasi rail-to-rail input stage and a push-pull rail-to-rail output stage. ELM832xC can operate down to 1.2V. ELM832xC is suitable for portable devices which require low power and a single voltage source.

## ■Features

- Operation from a single power source
- Low voltage operation :  $1.2V \leq V_{dd} \leq 6.0V$
- Low current consumption : Typ.21μA( $V_{dd}=3.0V$ )
- N-channel depletion differential input
  - : No gm dependence on input operating points
- Common-mode input voltage range
  - : Quasi rail-to-rail input
  - $V_{ss}$  to  $V_{dd}-0.3V$ ( $V_{dd}=1.5V$ )
  - $V_{ss}$  to  $V_{dd}-0.1V$ ( $V_{dd}=3.0V$ )
- Output stage : Push-pull rail-to-rail output
- Unity gain bandwidth : Typ.150kHz( $V_{dd} \geq 1.5V$ )
- Package : SOT-25, SC-70-5(SOT-353)

## ■Application

- Battery-operated portable devices
- Micropower signal process
- Low voltage analog circuit

## ■Maximum absolute ratings

Parameter	Symbol	Limit	Unit
Power supply voltage	V <sub>dd</sub>	7.0	V
Input voltage	V <sub>in</sub>	V <sub>ss</sub> -0.3 to V <sub>dd</sub> +0.3	V
Output voltage	V <sub>out</sub>	V <sub>ss</sub> -0.3 to V <sub>dd</sub> +0.3	V
Output short circuit		Continuous	Sec.
Power dissipation	P <sub>d</sub>	300 (SOT-25)	mW
		150 (SC-70-5(SOT-353))	
Operating temperature	T <sub>op</sub>	-40 to +85	°C
Storage temperature	T <sub>stg</sub>	-55 to +125	°C

## ■Selection guide

ELM832xC-x

Symbol		
a	Package	B: SOT-25 C: SC-70-5(SOT-353)
b	Product version	C
c	Taping direction	S, N: Refer to PKG file

ELM832 x C - x  
 ↑ ↑ ↑  
 a b c

# ELM832xC 20 $\mu$ A Low power CMOS operational amplifier

<http://www.elm-tech.com>

## ■ Pin configuration

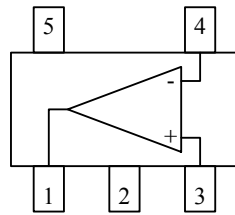

Pin No.	Pin name
1	OUT
2	VDD
3	IN+
4	IN-
5	VSS

## ■ Standard circuit

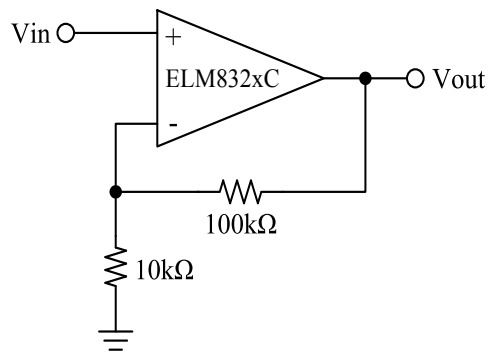

## ■ Marking

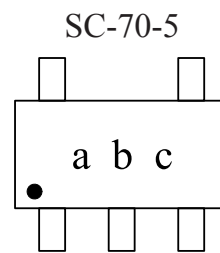
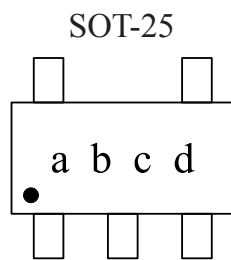

Symbol	Mark	Content
a, b	5 B	ELM832BC (SOT-25)
	> 1	ELM832CC (SC-70-5)
c	0 to 9 and A to Z (I, O, X excepted.)	Lot No.
d	0 to 9 and A to Z (I, O, X excepted.)	Lot No.

# ELM832xC 20 $\mu$ A Low power CMOS operational amplifier

http://www.elm-tech.com

## ■ Electrical characteristics

V<sub>ss</sub>=0V, Top=-40~+85°C

Parameter	Symbol	Condition	Min.	Typ.	Max.	Unit
Operating voltage	V <sub>dd</sub>		1.2		6.0	V

V<sub>dd</sub>=1.5V

V<sub>ss</sub>=0V, Top=25°C

Parameter	Symbol	Condition	Min.	Typ.	Max.	Unit
Input offset voltage	V <sub>io</sub>	V <sub>cm</sub> =V <sub>dd</sub> /2, Unity gain follower			±6	mV
Input bias current	I <sub>ib</sub>				1.0	nA
Common-mode input voltage range	V <sub>cmr</sub>	For CMRR $\geq$ 50dB	0.00		1.20	V
Maximum output voltage swing	V <sub>outsh</sub>	V <sub>id</sub> =100mV, R <sub>L</sub> =10k $\Omega$ to V <sub>ss</sub>	1.40			V
Minimum output voltage swing	V <sub>outsl</sub>	V <sub>id</sub> =100mV, R <sub>L</sub> =10k $\Omega$ to V <sub>dd</sub>			0.10	V
Source current	I <sub>source</sub>	V <sub>out</sub> =1.2V, V <sub>id</sub> =100mV	0.4	1.0		mA
Sink current	I <sub>sink</sub>	V <sub>out</sub> =0.3V, V <sub>id</sub> =100mV	1.0	2.5		mA
Large-signal voltage gain	A <sub>vd</sub>	R <sub>L</sub> =10k $\Omega$ to V <sub>ss</sub> , V <sub>cm</sub> =0.75V		100		dB
Common-mode rejection ratio	CMRR	R <sub>L</sub> =10k $\Omega$ to V <sub>ss</sub> , V <sub>cm</sub> =0.75V		80		dB
Supply voltage rejection ratio	PSRR	R <sub>L</sub> =10k $\Omega$ to V <sub>ss</sub> , V <sub>cm</sub> =0.75V		85		dB
Current consumption	I <sub>ss</sub>	V <sub>cm</sub> =V <sub>dd</sub> /2, Unity gain follower		20	40	$\mu$ A
Short current	I <sub>shortp</sub>	V <sub>out</sub> to V <sub>ss</sub> shrot, V <sub>id</sub> =100mV		1.4		mA
	I <sub>shortn</sub>	V <sub>out</sub> to V <sub>dd</sub> shrot, V <sub>id</sub> =100mV		4.0		mA
Unity gain bandwidth	GBW			150		kHz
Slew rate	SR	R <sub>L</sub> =100k $\Omega$ , C <sub>L</sub> =20pF	80	190		mV/ $\mu$ s

V<sub>dd</sub>=3.0V

V<sub>ss</sub>=0V, Top=25°C

Parameter	Symbol	Condition	Min.	Typ.	Max.	Unit
Input offset voltage	V <sub>io</sub>	V <sub>cm</sub> =V <sub>dd</sub> /2, Unity gain follower			±6	mV
Input bias current	I <sub>ib</sub>				1.0	nA
Common-mode input voltage range	V <sub>cmr</sub>	For CMRR $\geq$ 50dB	0.00		2.90	V
Maximum output voltage swing	V <sub>outsh</sub>	V <sub>id</sub> =100mV, R <sub>L</sub> =10k $\Omega$ to V <sub>ss</sub>	2.90			V
Minimum output voltage swing	V <sub>outsl</sub>	V <sub>id</sub> =100mV, R <sub>L</sub> =10k $\Omega$ to V <sub>dd</sub>			0.10	V
Source current	I <sub>source</sub>	V <sub>out</sub> =2.7V, V <sub>id</sub> =100mV	1.5	4.0		mA
Sink current	I <sub>sink</sub>	V <sub>out</sub> =0.3V, V <sub>id</sub> =100mV	3.0	7.5		mA
Large-signal voltage gain	A <sub>vd</sub>	R <sub>L</sub> =10k $\Omega$ to V <sub>ss</sub> , V <sub>cm</sub> =1.5V		105		dB
Common-mode rejection ratio	CMRR	R <sub>L</sub> =10k $\Omega$ to V <sub>ss</sub> , V <sub>cm</sub> =1.5V		85		dB
Supply voltage rejection ratio	PSRR	R <sub>L</sub> =10k $\Omega$ to V <sub>ss</sub> , V <sub>cm</sub> =1.5V		100		dB
Current consumption	I <sub>ss</sub>	V <sub>cm</sub> =V <sub>dd</sub> /2, Unity gain follower		21	45	$\mu$ A
Short current	I <sub>shortp</sub>	V <sub>out</sub> to V <sub>ss</sub> shrot, V <sub>id</sub> =100mV		14		mA
	I <sub>shortn</sub>	V <sub>out</sub> to V <sub>dd</sub> shrot, V <sub>id</sub> =100mV		25		mA
Unity gain bandwidth	GBW			150		kHz
Slew rate	SR	R <sub>L</sub> =100k $\Omega$ , C <sub>L</sub> =20pF	80	200		mV/ $\mu$ s

# ELM832xC 20 $\mu$ A Low power CMOS operational amplifier

<http://www.elm-tech.com>

## ■Note

### 1) Common mode input voltage range

ELM832xC common mode input voltage range is fixed under the condition of  $CMRR \geq 50\text{dB}$ ; ELM832xC is able to accept the input above its specification if the degradation of  $CMRR$  is not considered. Even if the input voltage exceeds either positive or negative power voltage, troubles such as reverse of output will not occur.

As maximum absolute rating, the input voltage is possible within  $(V_{ss}-0.3)\text{V}$  to  $(V_{dd}+0.3)\text{V}$ .

### 2) Operation from single power source

ELM832xC is designed to be most suitable for single power source, ELM832xC is able to share power supply with logic circuit one. Meanwhile, ELM832xC can also operate from double power sources. To protect power supplies of ELM832xC and logic circuit from noise, please separate wire from power supply and use decoupling (bypass) capacitor. Using the capacitor can improve PSRR characteristics, especially on 10kHz to 100kHz or more.

### 3) Feedback

When OP-AMP circuit is used with feedback resistor, oscillation may happen in the circuit with loop-gain like unity gain follower.

a) When large feedback resistance is used, the phase margin is decreased by its combination with the parasitic capacitance of the input part of OP-AMP. In this situation, please connect small capacitor in parallel with feedback resistor as shown in fig-1.

b) For capacitive load, external resistor in series connection will be effective as shown in fig-2.  
( $R_L=300$  to  $500\Omega$ )

c) Being used as an unity gain follow, ELM832xC is able to drive capacitive load of 100pF directly without oscillation.

a) fig-1

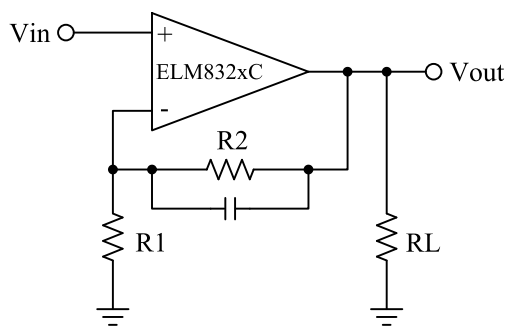

b) fig-2

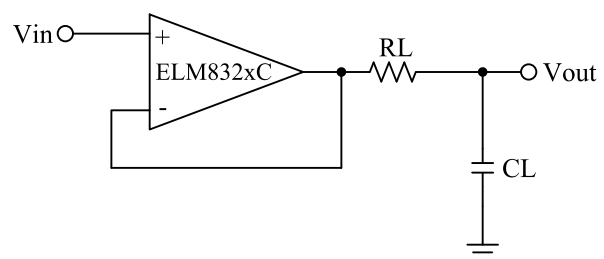

# ELM832xC 20 $\mu$ A Low power CMOS operational amplifier

<http://www.elm-tech.com>

## ■ Typical characteristics

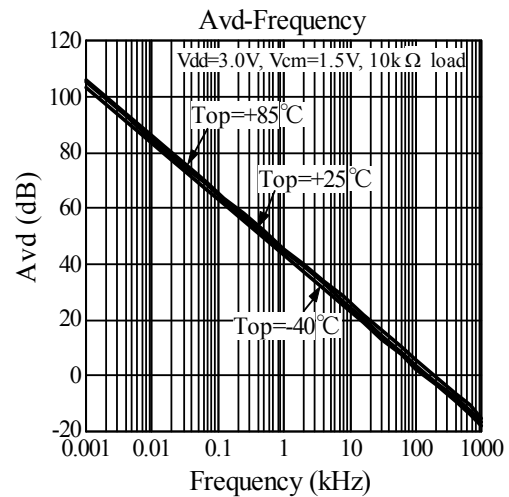
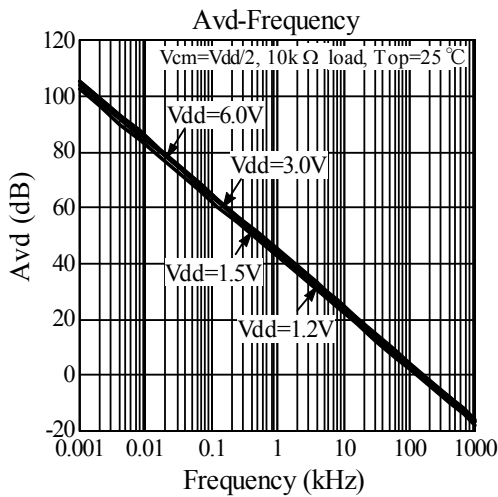
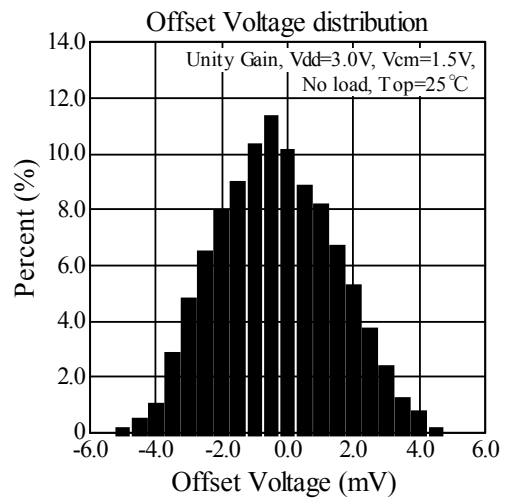
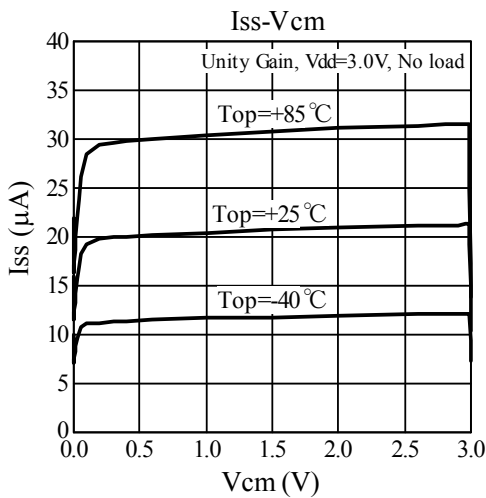
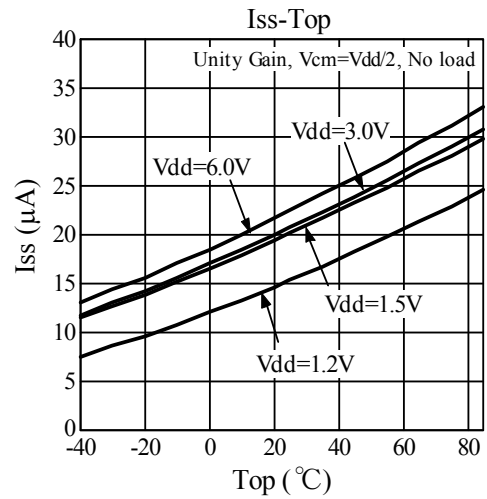
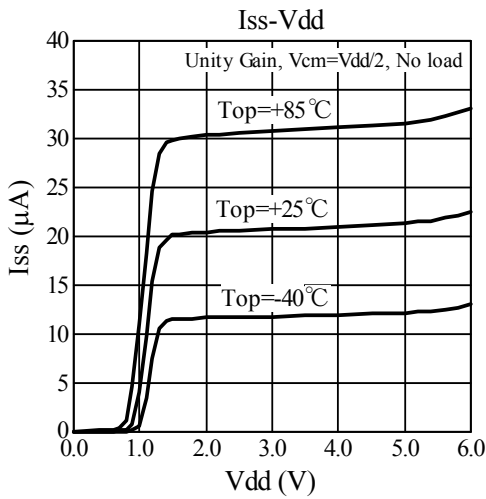

# ELM832xC 20 $\mu$ A Low power CMOS operational amplifier

<http://www.elm-tech.com>

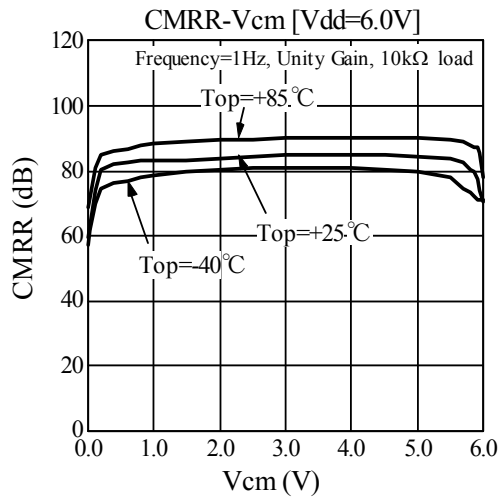
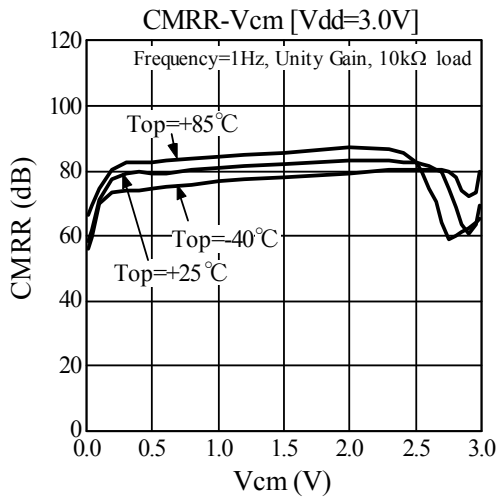
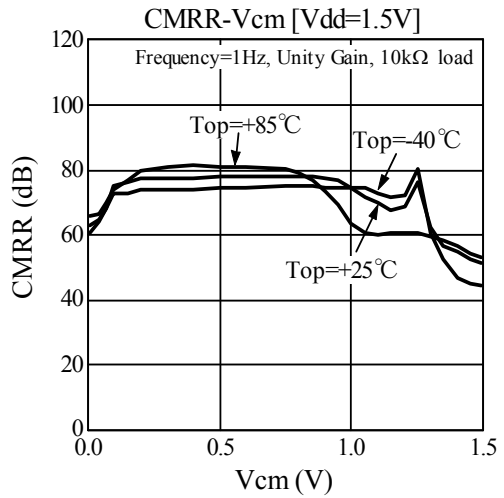
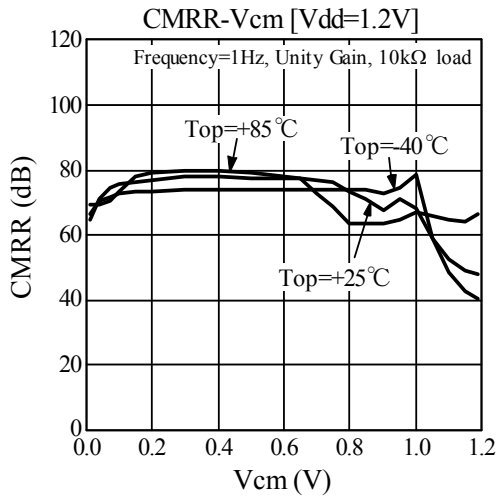
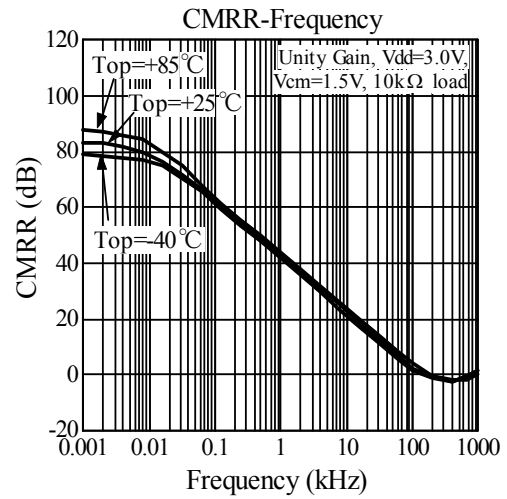
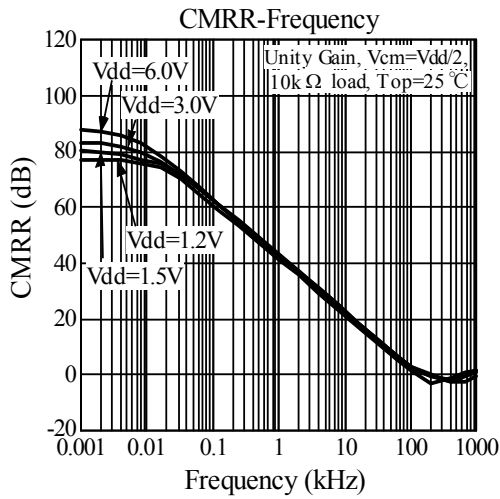

# ELM832xC 20 $\mu$ A Low power CMOS operational amplifier

<http://www.elm-tech.com>

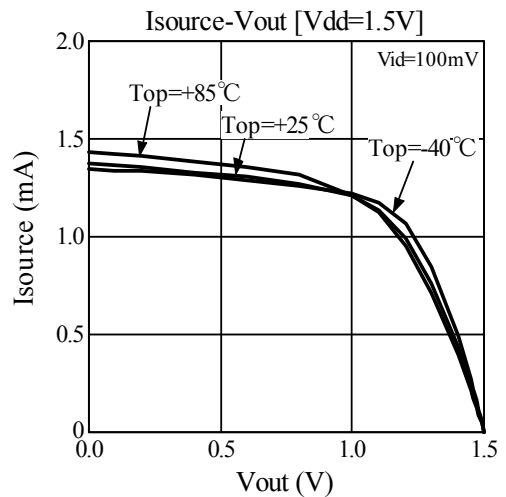
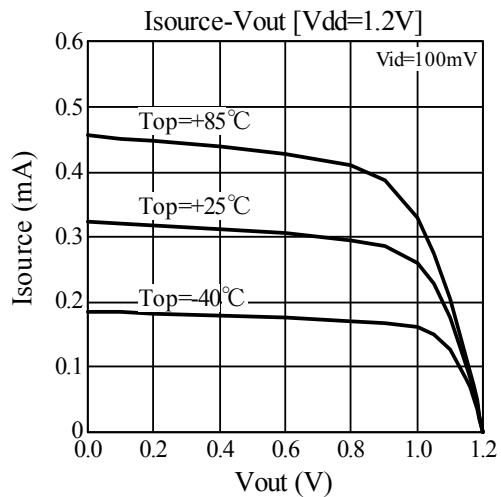
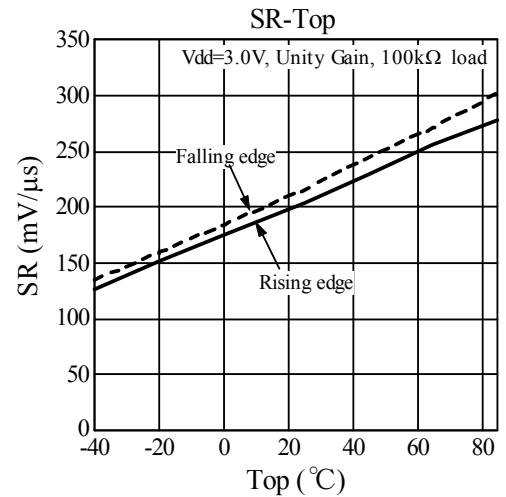
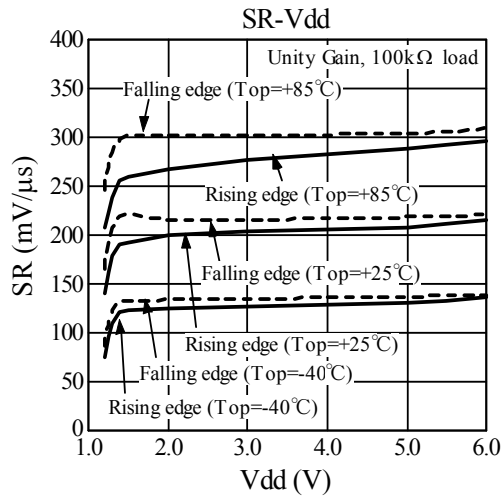
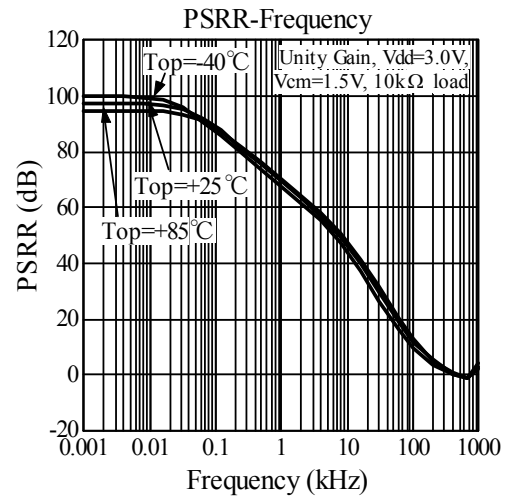
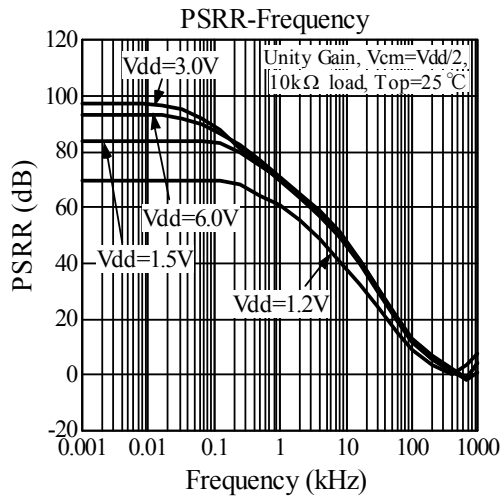

# ELM832xC 20 $\mu$ A Low power CMOS operational amplifier

<http://www.elm-tech.com>

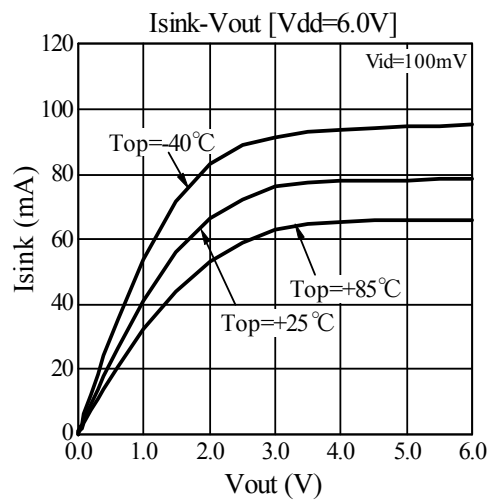
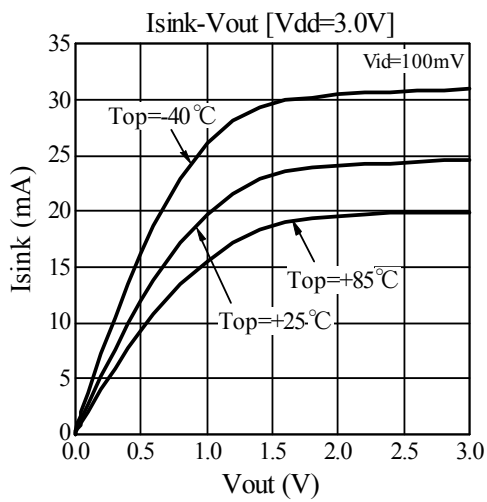
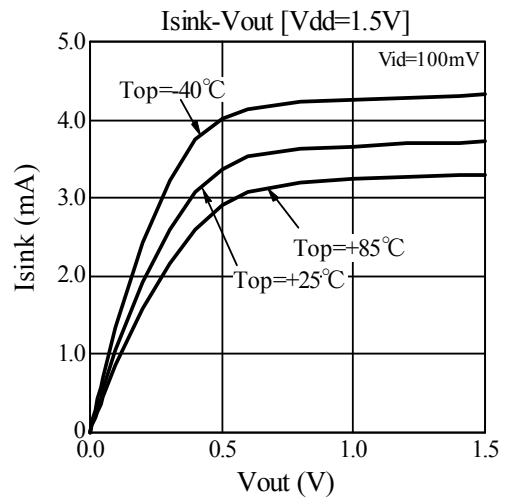
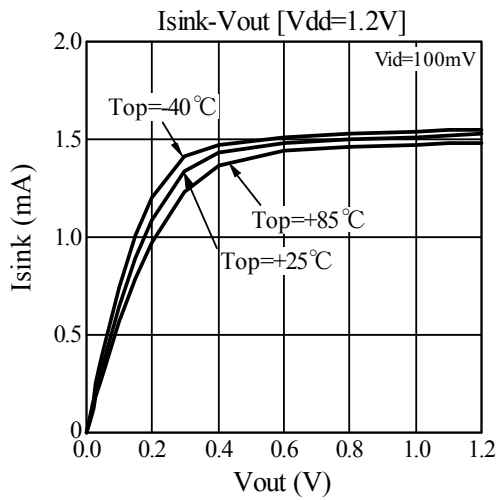
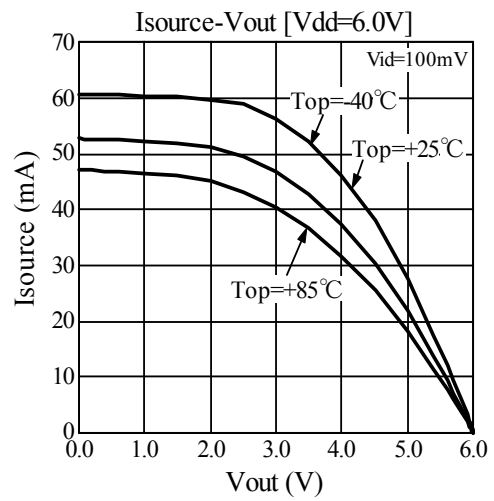
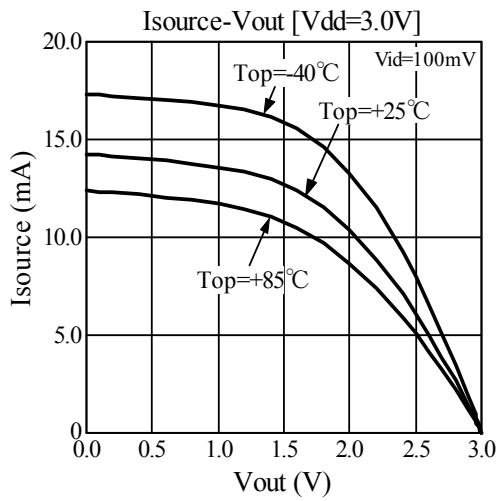



# ELM832xC 20 $\mu$ A Low power CMOS operational amplifier

<http://www.elm-tech.com>

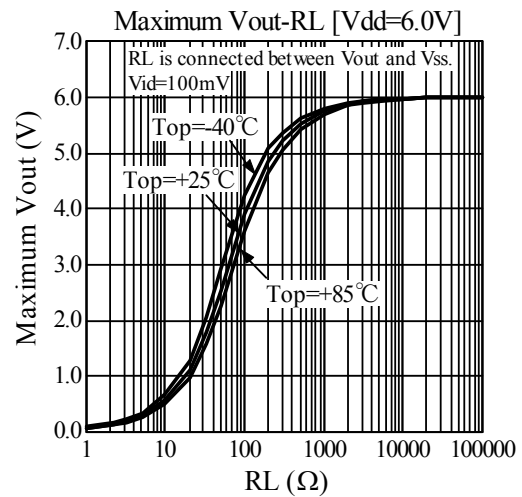
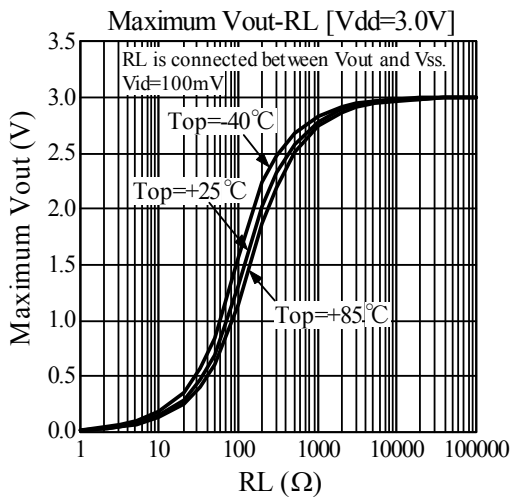
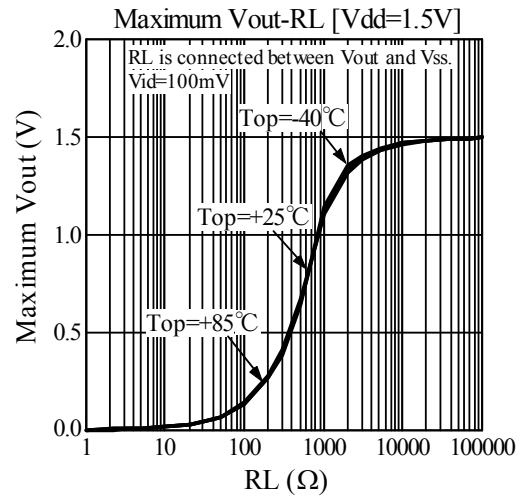
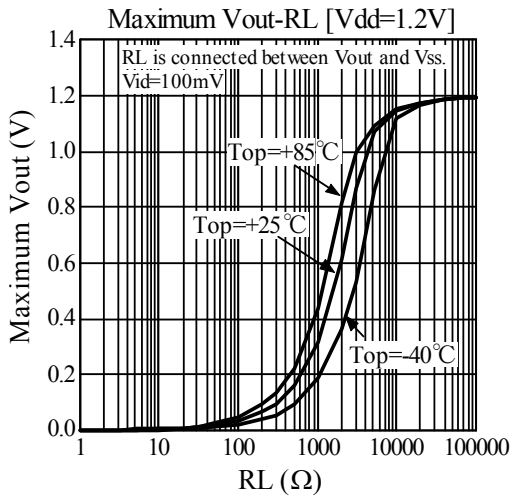
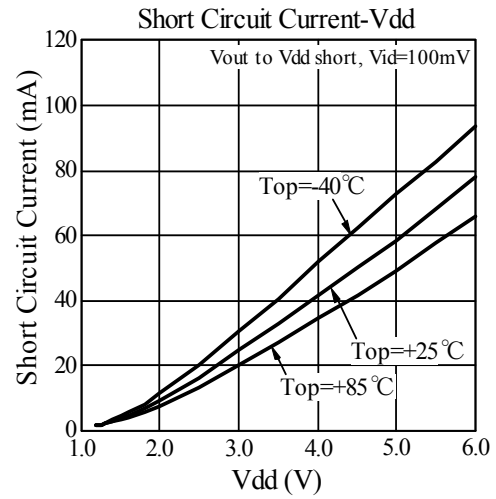
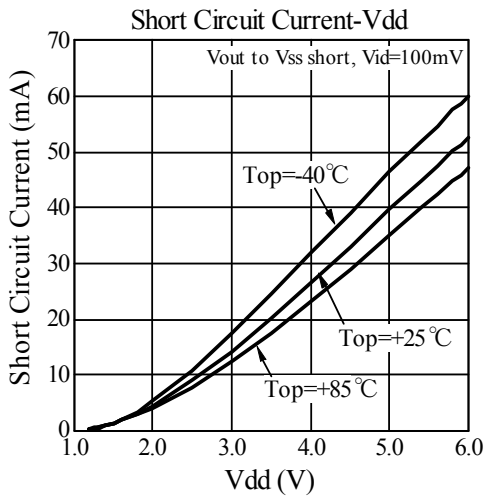

# ELM832xC 20 $\mu$ A Low power CMOS operational amplifier

<http://www.elm-tech.com>

