



SAW Components

SAW Duplexer

Automotive telematics

Series/type:	B4400
Ordering code:	B39212B4400P810
Date:	November 07, 2014
Version:	2.3

© EPCOS AG 2015. Reproduction, publication and dissemination of this publication, enclosures hereto and the information contained therein without EPCOS' prior express consent is prohibited.

EPCOS AG is a TDK Group Company.

Application

- Low-loss SAW duplexer for W-CDMA Band 1 (UMTS) systems
- Low insertion attenuation
- Low amplitude ripple
- Usable passband 60 MHz
- Single-ended to balanced transformation in Antenna-Rx path
- Impedance transformation 50 Ω to 100 Ω in Antenna-Rx path
- High isolation between Tx and Rx

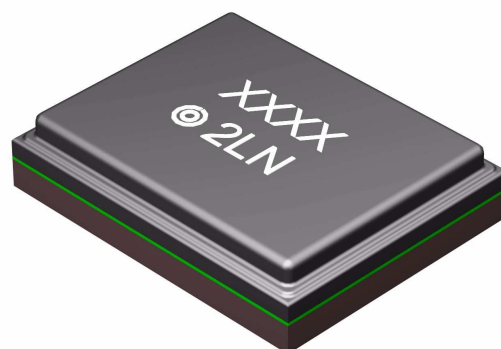
Features

- Package size 2.0 * 1.6 mm²
- Package height max. 0.45mm
- RoHS compatible
- Approximate weight 0.005 g
- Package for **Surface Mount Technology (SMT)**
- Ni terminals, Au-plated
- AEC-Q200 qualified component family (operable temperature range -40°C to +85°C)
- **Electrostatic Sensitive Device (ESD)**

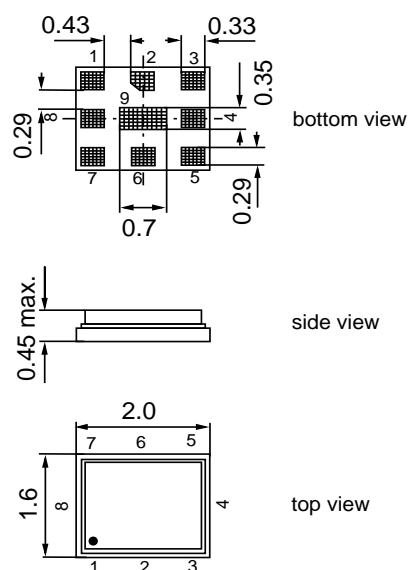
Pin configuration

- 3 Tx input
- 1, 8 Rx output (balanced)
- 6 Antenna
- 2, 4, 5, 7, 9 To be grounded

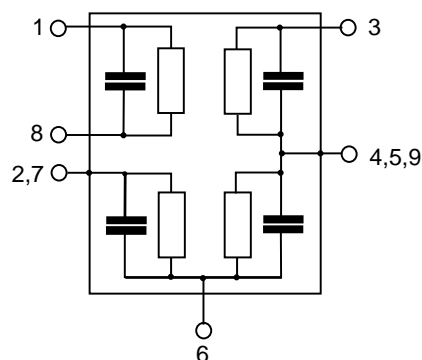

Data sheet

Characteristics

Temperature range for specification:	T = -20 °C to +85 °C
TX terminating impedance:	Z _{Tx} = 50 Ω 6.0 nH
ANT terminating impedance:	Z _{Ant} = 50 Ω 2.2 nH
RX terminating impedance:	Z _{Rx} = 100 Ω (balanced) 17 nH

Characteristics Tx-Antenna		min.	typ. @ 25 °C	max.	
Center frequency	f _c		1950.0		MHz
Maximum insertion attenuation	α _{W-CDMA} ¹⁾				
1922.4 ... 1977.6 MHz		—	1.7	2.3	dB
Amplitude ripple (p-p)	α _{W-CDMA} ¹⁾				
1922.4 ... 1977.6 MHz		—	0.5	1.1	dB
Error Vector Magnitude	EVM ²⁾				
1922.4 ... 1977.6 MHz		—	1.4	2.3	%
TX port VSWR					
1920.0 ... 1980.0 MHz		—	1.6	2.0	
ANT port VSWR					
1920.0 ... 1980.0 MHz		—	1.4	2.0	
Attenuation	α				
10.0 ... 410.0 MHz		45	69	—	dB
420.0 ... 494.0 MHz		43	64	—	dB
843.0 ... 894.0 MHz		40	47	—	dB
1565.0 ... 1574.0 MHz		41	45	—	dB
1574.0 ... 1577.0 MHz		42	46	—	dB
1577.0 ... 1586.0 MHz		42	47	—	dB
1597.0 ... 1605.0 MHz		43	48	—	dB
1605.0 ... 1805.0 MHz		34	39	—	dB
1805.0 ... 1865.0 MHz		30	36	—	dB
1865.0 ... 1880.0 MHz		12	33	—	dB
2112.4 ... 2167.6 MHz	α _{W-CDMA} ¹⁾	46	54	—	dB
2400.0 ... 2500.0 MHz		31	38	—	dB
2620.0 ... 2690.0 MHz		30	36	—	dB
3830.0 ... 3970.0 MHz		28	34	—	dB
5150.0 ... 5950.0 MHz		18	22	—	dB

1) Attenuation of W-CDMA signal (Power Transfer Function). Please, refer to page 7 of this document.

2) Error Vector Magnitude (EVM) based on definition given in 3GPP TS 25.141

Data sheet

Characteristics

Temperature range for specification:	T = -20 °C to +85 °C
TX terminating impedance:	Z _{TX} = 50 Ω 6.0 nH
ANT terminating impedance:	Z _{Ant} = 50 Ω 2.2 nH
RX terminating impedance:	Z _{RX} = 100 Ω (balanced) 17 nH

Characteristics Antenna-Rx		min.	typ. @ 25 °C	max.	
Center frequency	f _c		2140.0		MHz
Maximum insertion attenuation	α _{W-CDMA} ¹⁾				
2112.4 ... 2167.6 MHz		—	2.2	2.4	dB
Amplitude ripple (p-p)	α _{W-CDMA} ¹⁾				
2112.4 ... 2167.6 MHz		—	0.4	0.8	dB
Error Vector Magnitude	EVM ²⁾				
2112.4 ... 2167.6 MHz		—	1.0	2.0	%
ANT port VSWR					
2110.0 ... 2170.0 MHz		—	1.8	2.2	
RX port VSWR					
2110.0 ... 2170.0 MHz		—	1.6	2.0	

1) Attenuation of W-CDMA signal (Power Transfer Function). Please, refer to page 7 of this document.

2) Error Vector Magnitude (EVM) based on definition given in 3GPP TS 25.141

Data sheet

Characteristics

Temperature range for specification:	T = -20 °C to +85 °C
TX terminating impedance:	Z _{Tx} = 50 Ω 6.0 nH
ANT terminating impedance:	Z _{Ant} = 50 Ω 2.2 nH
RX terminating impedance:	Z _{Rx} = 100 Ω (balanced) 17 nH

Characteristics Antenna-Rx				min.	typ. @ 25 °C	max.	
Attenuation			α				
	10.0 ... 1920.0	MHz		45	53	—	dB
	1922.4 ... 1977.6	MHz	$\alpha_{W-CDMA}^{1)}$	50	55	—	dB
	1980.0 ... 2025.0	MHz		33	49	—	dB
	2255.0 ... 2400.0	MHz		25	45	—	dB
	2400.0 ... 2484.0	MHz		41	44	—	dB
	2484.0 ... 5600.0	MHz		40	45	—	dB
	5600.0 ... 6000.0	MHz		28	32	—	dB

1) Attenuation of W-CDMA signal (Power Transfer Function). Please, refer to page 7 of this document.

Data sheet

Characteristics

Temperature range for specification:	T = -20 °C to +85 °C
TX terminating impedance:	Z _{Tx} = 50 Ω 6.0 nH
ANT terminating impedance:	Z _{Ant} = 50 Ω 2.2 nH
RX terminating impedance:	Z _{Rx} = 100 Ω (balanced) 17 nH

Characteristics Tx-Rx				min.	typ. @ 25 °C	max.	
Differential Mode Isolation							
			α				
1574.0	...	1577.0	MHz	40	79	—	dB
1922.4	...	1977.6	MHz	52	57	—	dB
2112.4	...	2167.6	MHz	53	59	—	dB
3830.0	...	3970.0	MHz	30	61	—	dB
5750.0	...	5950.0	MHz	30	44	—	dB
Common Mode Isolation							
			α				
1922.4	...	1977.6	MHz	42	45	—	dB

1) Attenuation of W-CDMA signal (Power Transfer Function). Please, refer to page 7 of this document.

Data sheet

Annotation for characteristics section

Attenuation of W-CDMA signal (Power Transfer Function, α_{W-CDMA}) is determined by

$$\int_{-\infty}^{\infty} |S_{ds21}(f)H_{RRC}(f - f_{Carrier})|^2 df$$

with $f_{Carrier}$ according to 3GPP TS 25.101 (e.g. for UMTS pass band, $f_{Carrier}$ ranges from 1922.4 MHz (lowest Tx channel) to 2167.6 MHz (highest Tx channel)). Here, $H_{RRC}(f)$ is the transfer function of the root-raised cosine transmit pulse shaping filter according to 3GPP TS 25.101 with the following normalization:

$$\int_{-\infty}^{\infty} |H_{RRC}(f)|^2 df = 1$$

Data sheet

Maximum Ratings

Operable temperature range	T	-40/+85	°C	
Storage temperature range	T _{stg}	-40/+85	°C	
DC voltage	V _{DC}	0	V	
ESD voltage	V _{ESD}	50 ¹⁾	V	machine model, 10 pulses
Input power at				
1920.0 ... 1980.0 MHz	P _{in}	29	dBm	} continuous wave 50 °C, 5000h
elsewhere	P _{in}	10	dBm	

1) According to JESD22-A115A (machine model), 10 negative and 10 positive pulses.

Data sheet

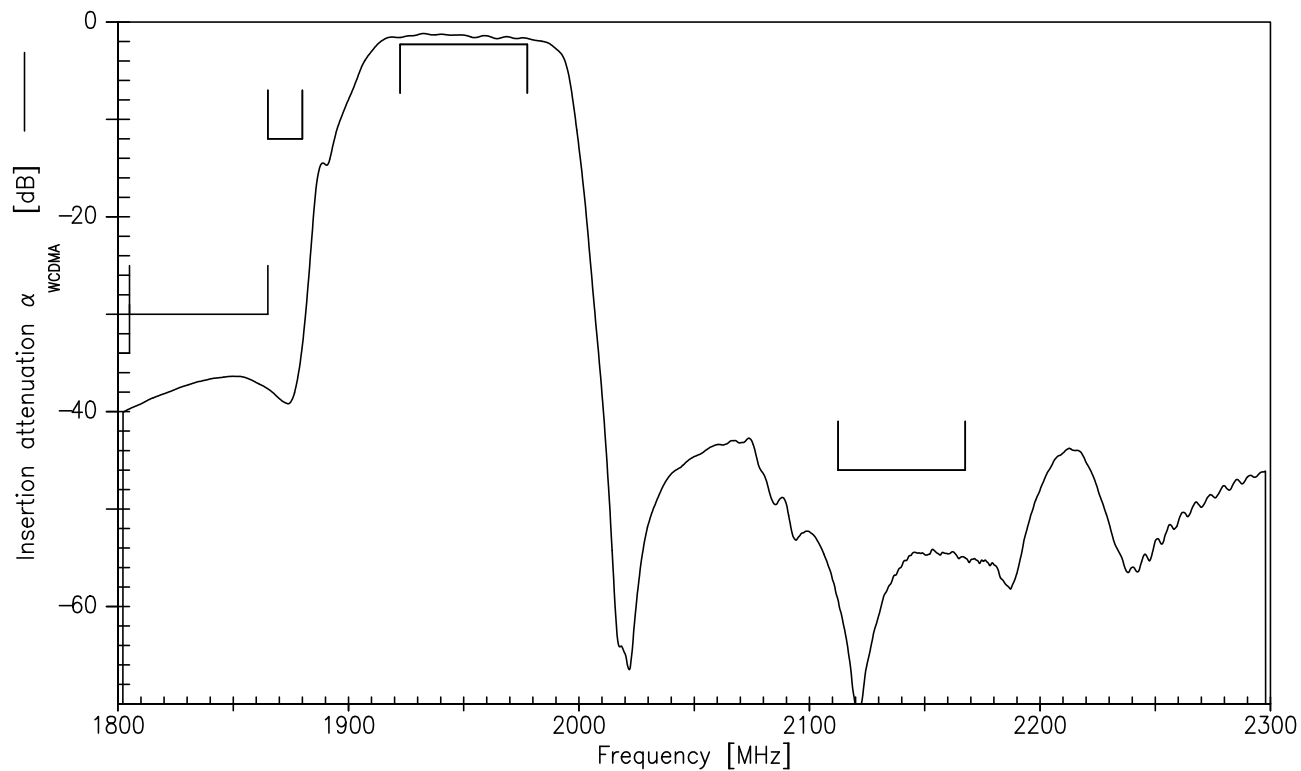
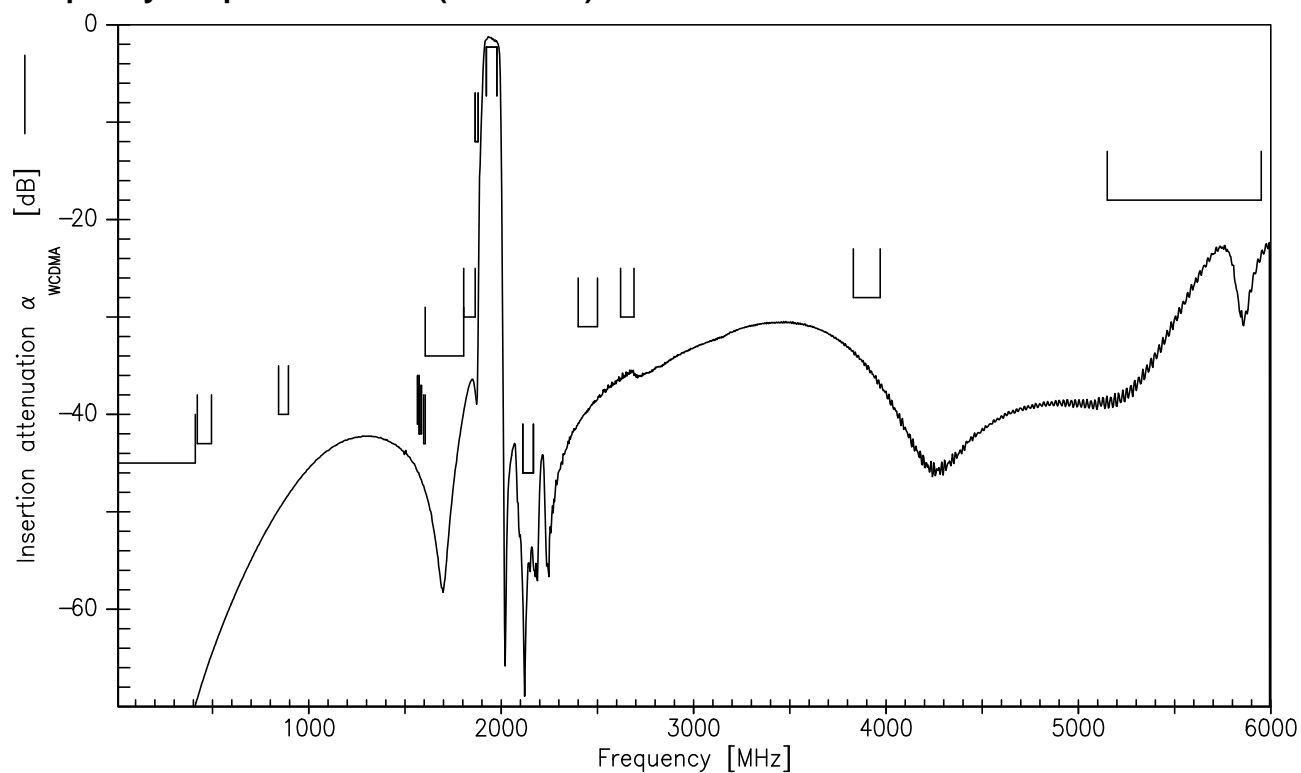
Frequency Response TX-ANT

Frequency Response TX-ANT (wideband)

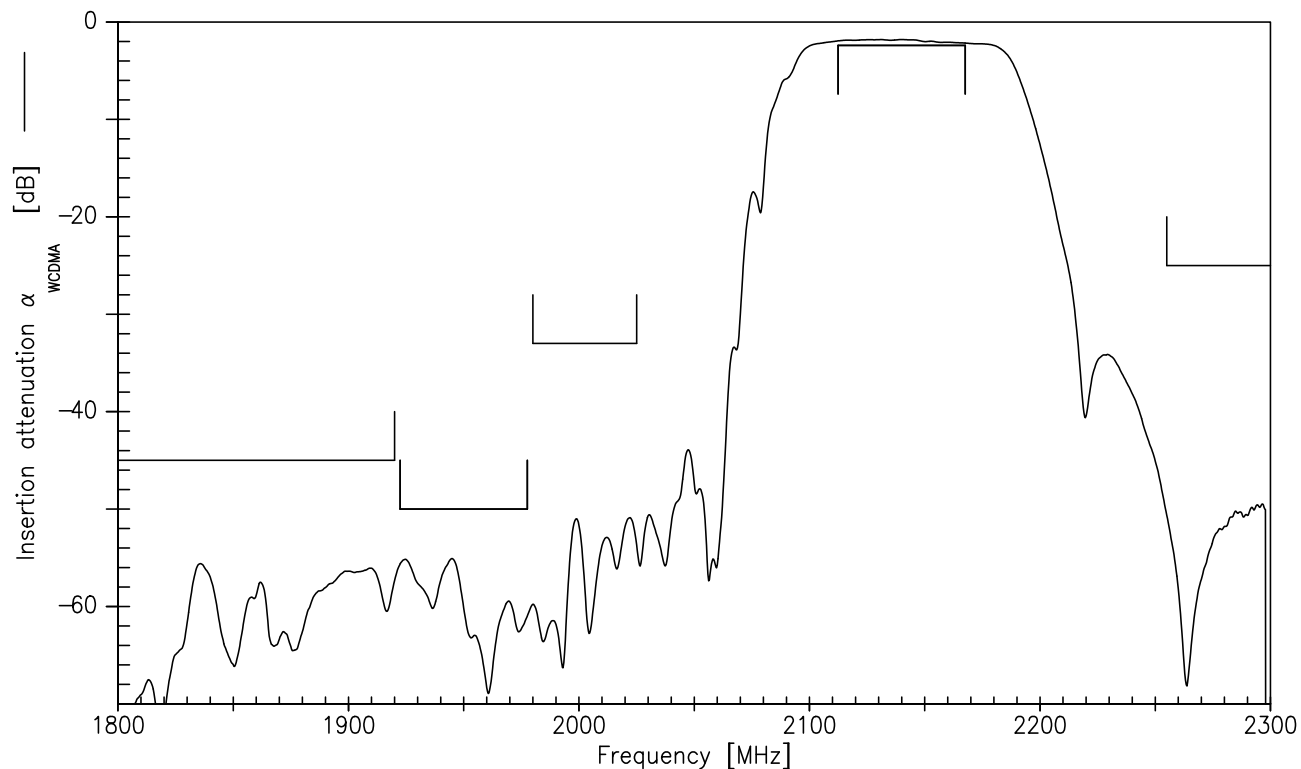
Frequency Response RX-ANT

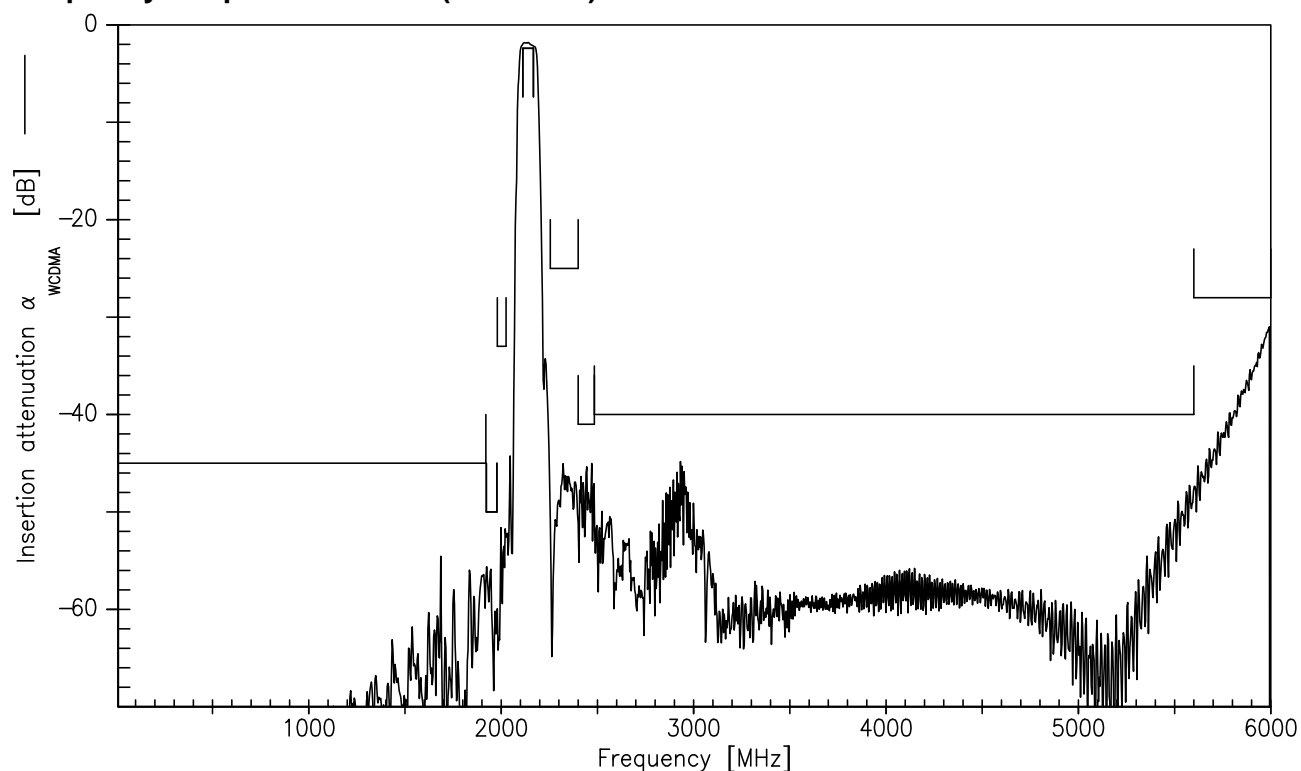

Frequency Response RX-ANT (wideband)



Frequency Response TX-RX

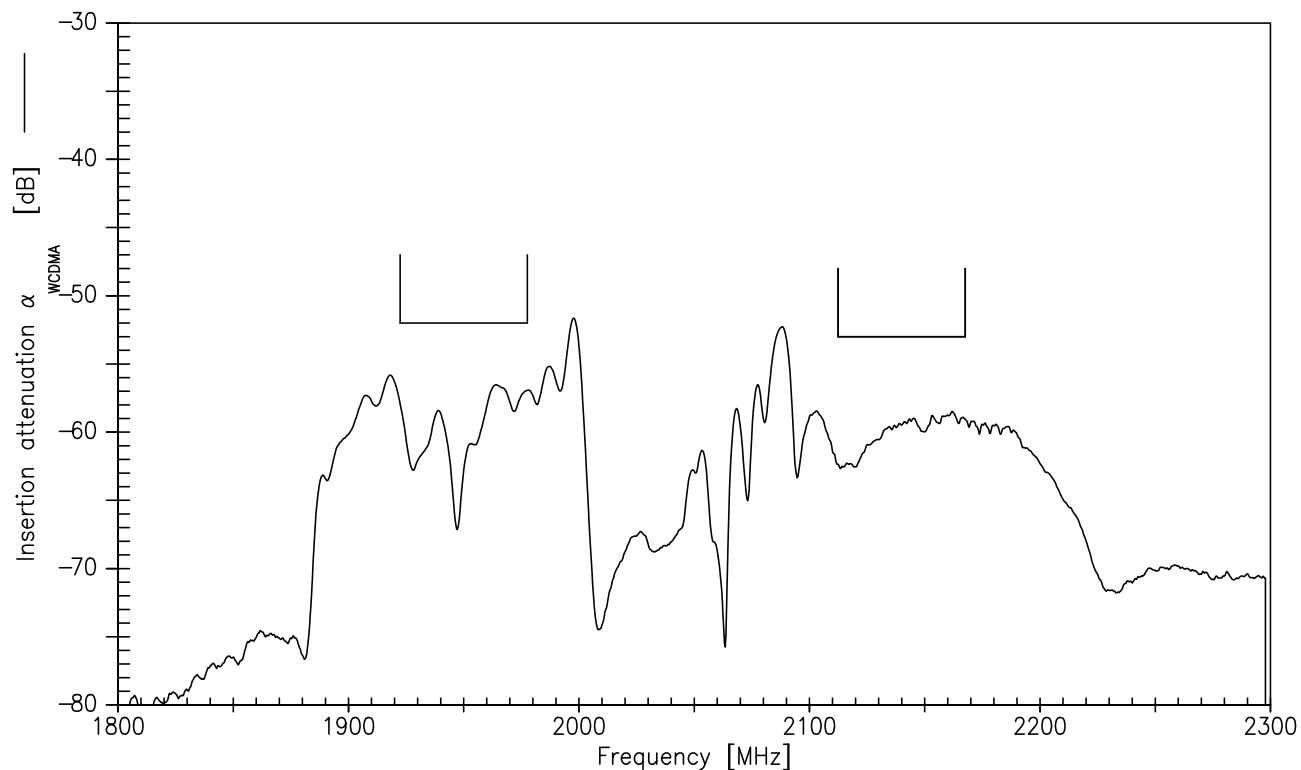

Frequency Response TX-RX (wideband)

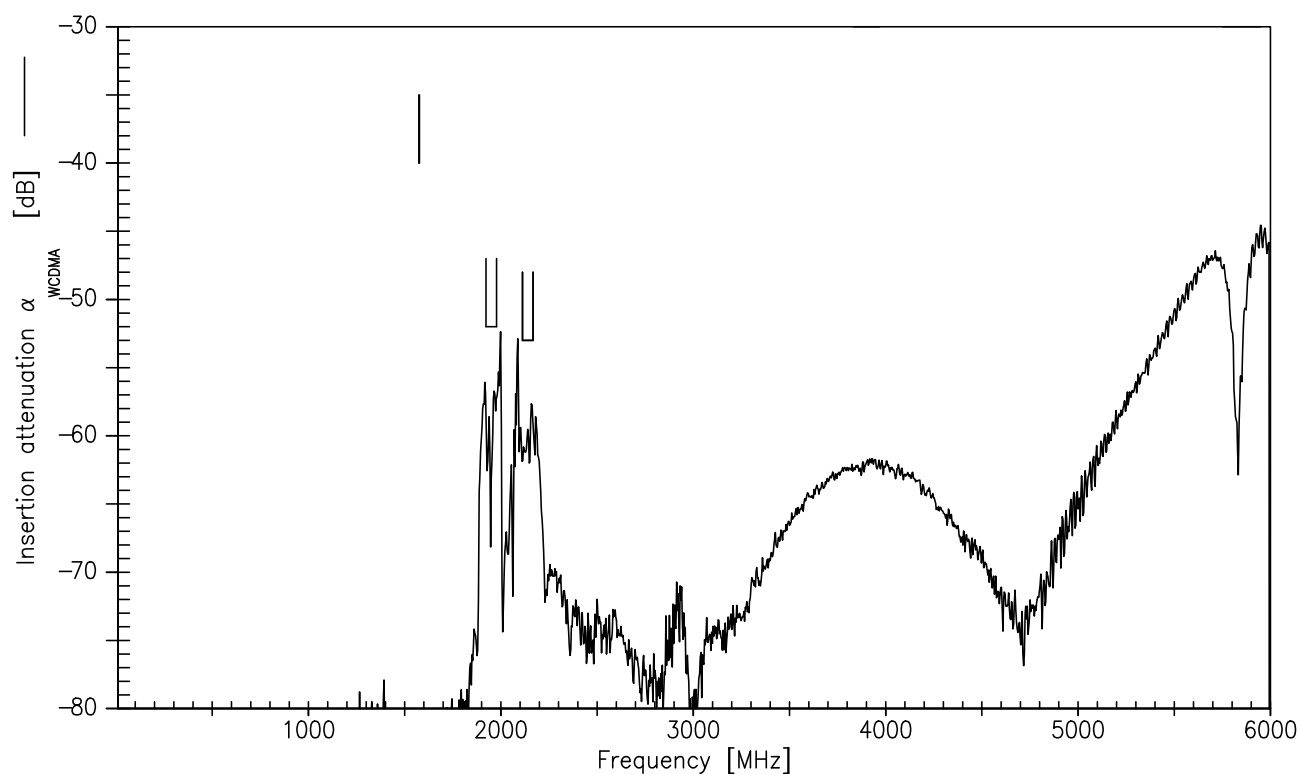

Data sheet

SMD

Return Loss

S_{11} TX- port

S_{33} RX-port

S_{22} ANT-port

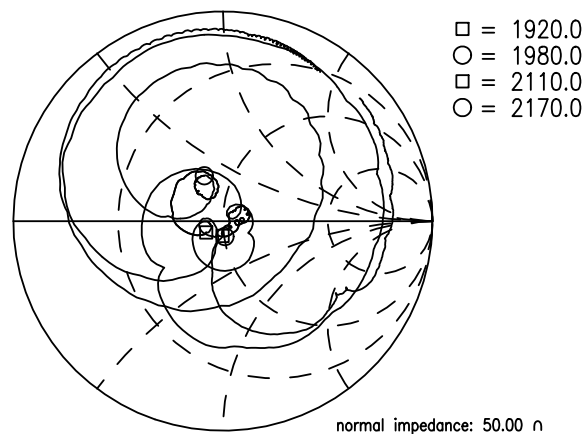
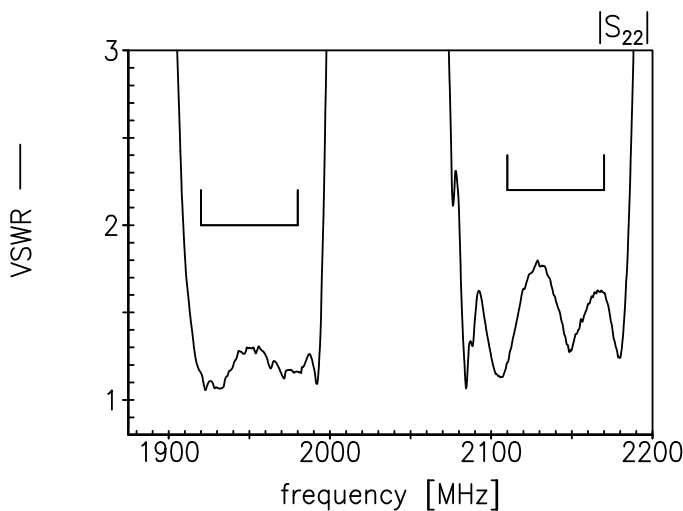
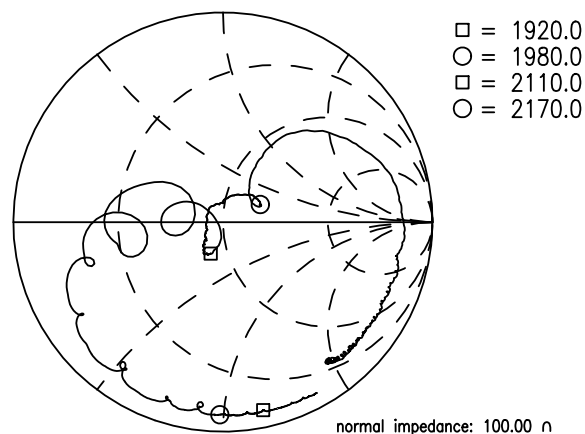
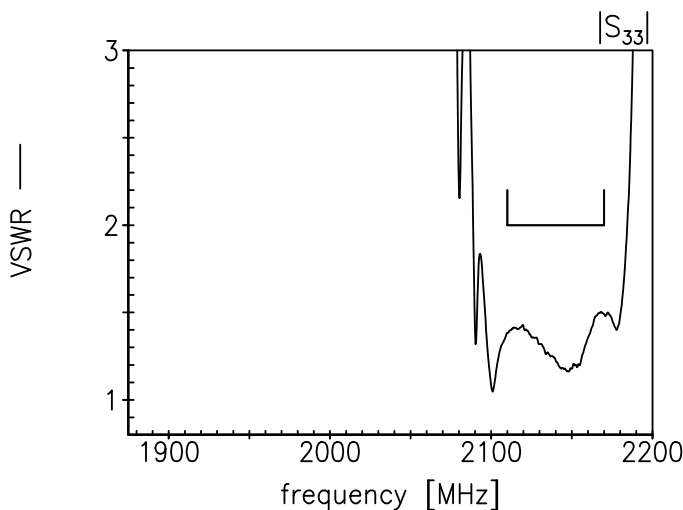
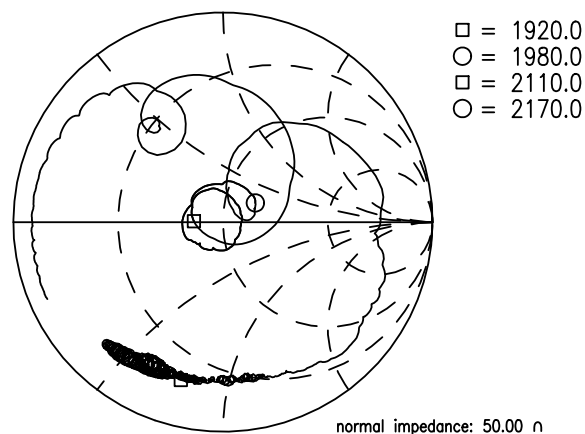
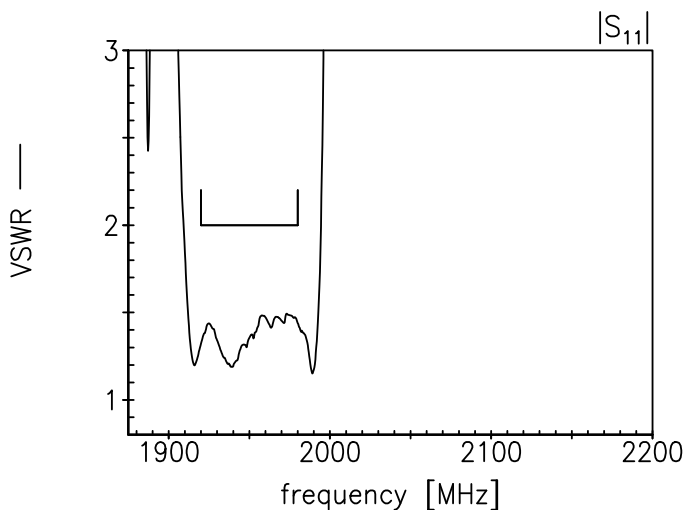

Data sheet



References

Type	B4400
Ordering code	B39212B4400P810
Marking and package	C61157-A8-A50
Packaging	F61074-V8247-Z000
Date codes	L_1126
S-parameters	B4400_NB_UN.s4p, B4400_WB_UN.s4p See file header for port/pin assignment table.
Soldering profile	S_6001
RoHS compatible	RoHS-compatible means that products are compatible with the requirements according to Art. 4 (substance restrictions) of Directive 2011/65/EU of the European Parliament and of the Council of June 8 th , 2011, on the restriction of the use of certain hazardous substances in electrical and electronic equipment ("Directive") with due regard to the application of exemptions as per Annex III of the Directive in certain cases.
Moldability	Before using in overmolding environment, please contact your EPCOS sales office.
Matching coils	See Inductor pdf-catalog http://www.tdk.co.jp/tefe02/coil.htm#aname1 and Data Library for circuit simulation http://www.tdk.co.jp/etvcl/index.htm

For further information please contact your local EPCOS sales office or visit our webpage at www.epcos.com.

Published by EPCOS AG

Systems, Acoustics, Waves Business Group

P.O. Box 80 17 09, 81617 Munich, GERMANY

© EPCOS AG 2014. This brochure replaces the previous edition.

For questions on technology, prices and delivery please contact the Sales Offices of EPCOS AG or the international Representatives.

Due to technical requirements components may contain dangerous substances. For information on the type in question please also contact one of our Sales Offices.

The following applies to all products named in this publication:

1. Some parts of this publication contain **statements about the suitability of our products for certain areas of application**. These statements are based on our knowledge of typical requirements that are often placed on our products in the areas of application concerned. We nevertheless expressly point out **that such statements cannot be regarded as binding statements about the suitability of our products for a particular customer application**. As a rule, EPCOS is either unfamiliar with individual customer applications or less familiar with them than the customers themselves. For these reasons, it is always ultimately incumbent on the customer to check and decide whether an EPCOS product with the properties described in the product specification is suitable for use in a particular customer application.
2. We also point out that **in individual cases, a malfunction of electronic components or failure before the end of their usual service life cannot be completely ruled out in the current state of the art, even if they are operated as specified**. In customer applications requiring a very high level of operational safety and especially in customer applications in which the malfunction or failure of an electronic component could endanger human life or health (e.g. in accident prevention or life-saving systems), it must therefore be ensured by means of suitable design of the customer application or other action taken by the customer (e.g. installation of protective circuitry or redundancy) that no injury or damage is sustained by third parties in the event of malfunction or failure of an electronic component.
3. **The warnings, cautions and product-specific notes must be observed.**
4. In order to satisfy certain technical requirements, **some of the products described in this publication may contain substances subject to restrictions in certain jurisdictions (e.g. because they are classed as hazardous)**. Useful information on this will be found in our Material Data Sheets on the Internet (www.epcos.com/material). Should you have any more detailed questions, please contact our sales offices.
5. We constantly strive to improve our products. Consequently, **the products described in this publication may change from time to time**. The same is true of the corresponding product specifications. Please check therefore to what extent product descriptions and specifications contained in this publication are still applicable before or when you place an order. We also **reserve the right to discontinue production and delivery of products**. Consequently, we cannot guarantee that all products named in this publication will always be available. The aforementioned does not apply in the case of individual agreements deviating from the foregoing for customer-specific products.
6. Unless otherwise agreed in individual contracts, **all orders are subject to the current version of the "General Terms of Delivery for Products and Services in the Electrical Industry" published by the German Electrical and Electronics Industry Association (ZVEI)**.
7. The trade names EPCOS, BAOKE, Alu-X, CeraDiode, CeraLink, CeraPlas, CSMP, CSSP, CTVS, DeltaCap, DigiSiMic, DSSP, FilterCap, FormFit, MiniBlue, MiniCell, MKD, MKK, MLSC, MotorCap, PCC, PhaseCap, PhaseCube, PhaseMod, PhiCap, SIFERRIT, SIFI, SIKOREL, SilverCap, SIMDAD, SiMic, SIMID, SineFormer, SIOV, SIP5D, SIP5K, TFAP, ThermoFuse, WindCap are **trademarks registered or pending** in Europe and in other countries. Further information will be found on the Internet at www.epcos.com/trademarks.