



# SAW Components

## SAW Duplexer

WCDMA Band 4/ CDMA 1x AWS Band

<b>Series/type:</b>	<b>B8524</b>
<b>Ordering Code:</b>	<b>B39212B8524P810</b>
Date:	July 12, 2013
Version:	2.0

© EPCOS AG 2015. Reproduction, publication and dissemination of this publication, enclosures hereto and the information contained therein without EPCOS' prior express consent is prohibited.

EPCOS AG is a TDK Group Company.

**Data Sheet**

**Application**

- Low-loss SAW duplexer for mobile telephone WCDMA Band 4 / CDMA 1x AWS systems
- Low insertion attenuation
- Low amplitude ripple
- Usable passband 45 MHz
- Single-ended to balanced transformation in Antenna-Rx path
- Impedance transformation 50Ω to 100Ω in Antenna-Rx path
- High isolation between Tx and Rx

**Features**

- Package size 1.8 x 1.4 mm<sup>2</sup>, package height 0.475 mm max.
- RoHS compatible
- Approx. weight 0.005g
- Package for Surface Mount Technology (SMT)
- Ni, Au-plated terminals
- Balanced Rx port, unbalanced Tx port
- **E**lectrostatic **S**ensitive **D**evice (**ESD**)
- **M**oisture **S**ensitivity **L**evel 3

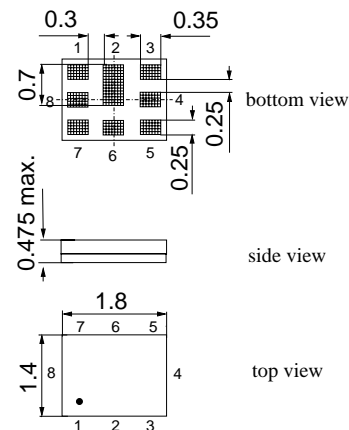
**Pin configuration**

- 3 Tx input, unbalanced
- 1,8 Rx output, balanced
- 6 Antenna
- 2, 4, 5, 7 To be grounded

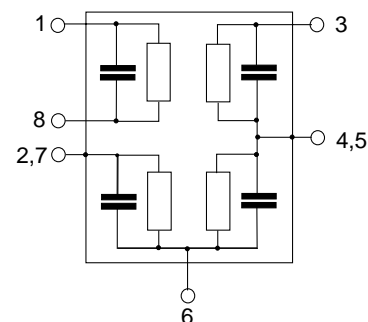

**Characteristics for W-CDMA Band 4**

Temperature range for specification:	T = -15 °C to +80 °C
Antenna terminating impedance:	Z <sub>ANT</sub> = 50 Ω    2.6nH
RX terminating impedance:	Z <sub>RX</sub> = 100 Ω (balanced)    18nH
TX terminating impedance:	Z <sub>TX</sub> = 50 Ω

Characteristics TX - Antenna		B8524		
		min.	typ. @ 25 °C	max.
<b>Center frequency</b>	f <sub>C</sub>		1732.5	MHz
<b>Maximum insertion attenuation</b>	α			
@f <sub>Carrier</sub> 1712.4 ... 1752.6 MHz	α <sub>WCDMA</sub> <sup>1)</sup>		1.1	1.8 dB
<b>Amplitude ripple (p-p)</b>	Δα			
@f <sub>Carrier</sub> 1712.4 ... 1752.6 MHz	Δα <sub>WCDMA</sub> <sup>1)</sup>		0.4	0.9 dB
<b>Error vector magnitude</b>	EVM <sup>2)</sup>			
@f <sub>Carrier</sub> 1712.4 ... 1752.6 MHz			1.0	2.5 %
<b>Input VSWR (TX port)</b>				
1710.0 ... 1755.0 MHz			1.6	1.9
<b>Output VSWR (ANT port)</b>				
1710.0 ... 1755.0 MHz			1.5	1.9
<b>Attenuation</b>	α			
1.0 ... 728.0 MHz		30	45	dB
728.0 ... 764.0 MHz		35	45	dB
851.0 ... 894.0 MHz		35	42	dB
1310.0 ... 1355.0 MHz		24	38	dB
1565.42 ... 1573.374MHz		40	48	dB
1573.374 ... 1577.466MHz		45	50	dB
1577.466 ... 1585.42 MHz		40	51	dB
1597.5515... 1605.886MHz		40	47	dB
1805.0 ... 1880.0 MHz		20	46	dB
1930.0 ... 1990.0 MHz		40	46	dB
@f <sub>Carrier</sub> 2112.4 ... 2152.6 MHz	α <sub>WCDMA</sub> <sup>1)</sup>	42	46	dB
2400.0 ... 2500.0 MHz		30	39	dB
2565.0 ... 2677.0 MHz		5	35	dB
3410.0 ... 3510.0 MHz		25	31	dB
5000.0 ... 5120.0 MHz		10	20	dB
5120.0 ... 5350.0 MHz		12	20	dB
5350.0 ... 5725.0 MHz		10	26	dB
5725.0 ... 5850.0 MHz		18	25	dB
5850.0 ... 6000.0 MHz		10	25	dB

<sup>1)</sup> Attenuation of WCDMA signal ("Powertransferfunction"). Please refer to annotation on page (10).

<sup>2)</sup> Error Vector Magnitude (EVM) based on definition given in 3GPP TS 25.141.

**Data Sheet**

**Characteristics for W-CDMA Band 4**

Temperature range for specification:	T = -15 °C to +80 °C
Antenna terminating impedance:	Z <sub>ANT</sub> = 50 Ω    2.6nH
RX terminating impedance:	Z <sub>RX</sub> = 100 Ω (balanced)    18nH
TX terminating impedance:	Z <sub>TX</sub> = 50 Ω

Characteristics Antenna - Rx		B8524		
		min.	typ. @ 25 °C	max.
<b>Center frequency</b>	f <sub>C</sub>		2132.5	MHz
<b>Maximum insertion attenuation</b>	α			
@f <sub>Carrier</sub> 2112.4 ... 2152.6 MHz	α <sub>WCDMA</sub> <sup>1)</sup>		1.6	2.3 dB
<b>Amplitude ripple (p-p)</b>	Δα			
@f <sub>Carrier</sub> 2112.4 ... 2152.6 MHz	Δα <sub>WCDMA</sub> <sup>1)</sup>		0.4	1.0 dB
<b>Error vector magnitude</b>	EVM <sup>2)</sup>			
@f <sub>Carrier</sub> 2112.4 ... 2152.6 MHz			1.1	2.5 %
<b>Input VSWR (RX port)</b>				
2110.0 ... 2155.0 MHz			1.5	2.0
<b>Output VSWR (ANT port)</b>				
2110.0 ... 2155.0 MHz			1.7	2.0
<b>CMRR ( S<sub>32</sub>-S<sub>42</sub> / S<sub>32</sub>+S<sub>42</sub> )</b>				
2110.0 ... 2155.0 MHz		20 <sup>3)</sup>	29	dB

1) Attenuation of WCDMA signal ("Powertransferfunction"). Please refer to annotation on page (10).

2) Error Vector Magnitude (EVM) based on definition given in 3GPP TS 25.141.

3) A combination of 10 ° phase balance and 1 dB amplitude balance corresponds to 19.6 dB CMRR.

**Data Sheet**

**Characteristics for W-CDMA Band 4**

Temperature range for specification:	T = -15 °C to +80 °C
Antenna terminating impedance:	Z <sub>ANT</sub> = 50 Ω    2.6nH
RX terminating impedance:	Z <sub>RX</sub> = 100 Ω (balanced)    18nH
TX terminating impedance:	Z <sub>TX</sub> = 50 Ω

Characteristics Antenna - Rx				B8524		
				min.	typ. @ 25 °C	max.
<b>Attenuation</b>			$\alpha$			
	1.0 ... 400.0	MHz		57	> 70	dB
	400.0 ... 1310.0	MHz		40	67	dB
	1310.0 ... 1355.0	MHz		43	65	dB
	1355.0 ... 1710.0	MHz		35	49	dB
@f <sub>Carrier</sub>	1712.4 ... 1752.6	MHz	$\alpha_{\text{WCDMA}}^{1)}$	45	60	dB
	1755.0 ... 1910.0	MHz		15	53	dB
	1910.0 ... 1955.0	MHz		35	58	dB
	1955.0 ... 2025.0	MHz		15	37	dB
	2240.0 ... 2300.0	MHz		15	36	dB
	2300.0 ... 2400.0	MHz		30	46	dB
	2400.0 ... 2496.0	MHz		40	47	dB
	2496.0 ... 2690.0	MHz		40	52	dB
	2690.0 ... 3300.0	MHz		35	45	dB
	3300.0 ... 3800.0	MHz		45	51	dB
	3820.0 ... 3910.0	MHz		40	50	dB
	3910.0 ... 4220.0	MHz		35	50	dB
	4220.0 ... 4310.0	MHz		40	49	dB
	4310.0 ... 5150.0	MHz		35	47	dB
	5150.0 ... 5850.0	MHz		37	46	dB
	5850.0 ... 6000.0	MHz		35	42	dB

<sup>1)</sup> Attenuation of WCDMA signal ("Powertransferfunction"). Please refer to annotation on page (10).

**Data Sheet**

**Characteristics for W-CDMA Band 4**

Temperature range for specification:	T = -15 °C to +80 °C
Antenna terminating impedance:	Z <sub>ANT</sub> = 50 Ω    2.6nH
RX terminating impedance:	Z <sub>RX</sub> = 100 Ω (balanced)    18nH
TX terminating impedance:	Z <sub>TX</sub> = 50 Ω

Characteristics Tx - Rx				B8524			
				min.	typ. @ 25 °C	max.	
<b>Differential Mode Isolation</b> α							
	1574.0 ... 1577.0	MHz		40	68		dB
@f <sub>Carrier</sub>	1712.4 ... 1752.6	MHz	α <sub>WCDMA</sub> <sup>1)</sup>	55	59		dB
@f <sub>Carrier</sub>	2112.4 ... 2152.6	MHz	α <sub>WCDMA</sub> <sup>1)</sup>	50	57		dB
	3410.0 ... 3520.0	MHz		20	60		dB
	5120.0 ... 5275.0	MHz		20	55		dB
<b>Common Mode Isolation</b> α							
@f <sub>Carrier</sub>	1712.4 ... 1752.6	MHz	α <sub>WCDMA</sub> <sup>1)</sup>	46	51		dB

<sup>1)</sup> Attenuation of WCDMA signal ("Powertransferfunction"). Please refer to annotation on page (10).

**Characteristics for CDMA 1x AWS Band**

Temperature range for specification:	T = -30 °C to +85 °C
Antenna terminating impedance:	Z <sub>ANT</sub> = 50 Ω    2.6nH
RX terminating impedance:	Z <sub>RX</sub> = 100 Ω (balanced)    18nH
TX terminating impedance:	Z <sub>TX</sub> = 50 Ω

					B8524			
Characteristics TX - Antenna					min.	typ. @ 25 °C	max.	
<b>Center frequency</b>	f <sub>C</sub>					1732.5		MHz
<b>Maximum insertion attenuation</b>	α							
		1710.0 ... 1755.0	MHz			1.3	2.0	dB
<b>Amplitude ripple (p-p)</b>	Δα							
		1710.0 ... 1755.0	MHz			0.5	1.2	dB
<b>Input VSWR (TX port)</b>								
		1710.0 ... 1755.0	MHz			1.6	1.9	
<b>Output VSWR (ANT port)</b>								
		1710.0 ... 1755.0	MHz			1.5	1.9	
<b>Attenuation</b>	α							
		1.0 ... 728.0	MHz		30	45		dB
		728.0 ... 764.0	MHz		35	45		dB
		851.0 ... 894.0	MHz		35	42		dB
		1310.0 ... 1355.0	MHz		24	38		dB
		1565.42 ... 1573.374	MHz		40	48		dB
		1573.374 ... 1577.466	MHz		45	50		dB
		1577.466 ... 1585.42	MHz		40	51		dB
		1597.5515... 1605.886	MHz		40	47		dB
		1805.0 ... 1880.0	MHz		20	46		dB
		1930.0 ... 1990.0	MHz		40	46		dB
		2110.0 ... 2155.0	MHz		42	46		dB
		2400.0 ... 2500.0	MHz		30	39		dB
		2565.0 ... 2677.0	MHz		5	35		dB
		3410.0 ... 3510.0	MHz		25	31		dB
		5000.0 ... 5120.0	MHz		10	20		dB
		5120.0 ... 5350.0	MHz		12	20		dB
		5350.0 ... 5725.0	MHz		10	26		dB
		5725.0 ... 5850.0	MHz		18	25		dB
		5850.0 ... 6000.0	MHz		10	25		dB

**Characteristics for CDMA 1x AWS Band**

Temperature range for specification:	T = -30 °C to +85 °C
Antenna terminating impedance:	Z <sub>ANT</sub> = 50 Ω    2.6nH
RX terminating impedance:	Z <sub>RX</sub> = 100 Ω (balanced)    18nH
TX terminating impedance:	Z <sub>TX</sub> = 50 Ω

Characteristics Antenna - Rx				B8524		
				min.	typ. @ 25 °C	max.
<b>Center frequency</b>	f <sub>C</sub>		2132.5		MHz	
<b>Maximum insertion attenuation</b>	α					
2110.0 ... 2155.0 MHz			1.7	2.3	dB	
<b>Amplitude ripple (p-p)</b>	Δα					
2110.0 ... 2155.0 MHz			0.4	1.0	dB	
<b>Input VSWR (RX port)</b>						
2110.0 ... 2155.0 MHz			1.5	2.0		
<b>Output VSWR (ANT port)</b>						
2110.0 ... 2155.0 MHz			1.7	2.0		
<b>CMRR ( S<sub>32</sub>-S<sub>42</sub> / S<sub>32</sub>+S<sub>42</sub> )</b>						
2110.0 ... 2155.0 MHz		20 <sup>1)</sup>	29		dB	
<b>Attenuation</b>	α					
1.0 ... 400.0 MHz		57	> 70		dB	
400.0 ... 1310.0 MHz		40	67		dB	
1310.0 ... 1355.0 MHz		43	65		dB	
1355.0 ... 1710.0 MHz		35	49		dB	
1710.0 ... 1755.0 MHz		45	60		dB	
1755.0 ... 1910.0 MHz		15	53		dB	
1910.0 ... 1955.0 MHz		35	58		dB	
1955.0 ... 2025.0 MHz		15	37		dB	
2240.0 ... 2300.0 MHz		15	36		dB	
2300.0 ... 2400.0 MHz		30	46		dB	
2400.0 ... 2496.0 MHz		40	47		dB	
2496.0 ... 2690.0 MHz		40	52		dB	
2690.0 ... 3300.0 MHz		35	45		dB	
3300.0 ... 3800.0 MHz		45	51		dB	
3820.0 ... 3910.0 MHz		40	50		dB	
3910.0 ... 4220.0 MHz		35	50		dB	
4220.0 ... 4310.0 MHz		40	49		dB	
4310.0 ... 5150.0 MHz		35	47		dB	
5150.0 ... 5850.0 MHz		37	46		dB	
5850.0 ... 6475.0 MHz		35	42		dB	

<sup>1)</sup> A combination of 10° phase balance and 1 dB amplitude balance corresponds to 19.6 dB CMRR.



**Characteristics for CDMA 1x AWS Band**

Temperature range for specification:	T = -30 °C to +85 °C
Antenna terminating impedance:	Z <sub>ANT</sub> = 50 Ω    2.6nH
RX terminating impedance:	Z <sub>RX</sub> = 100 Ω (balanced)    18nH
TX terminating impedance:	Z <sub>TX</sub> = 50 Ω

				<b>B8524</b>			
<b>Characteristics Tx - Rx</b>				<b>min.</b>	<b>typ. @ 25 °C</b>	<b>max.</b>	
<b>Differential Mode Isolation</b> α							
	1574.0	... 1577.0	MHz	40	68		dB
	1710.0	... 1755.0	MHz	55	58		dB
	2110.0	... 2155.0	MHz	50	56		dB
	3410.0	... 3520.0	MHz	20	60		dB
	5120.0	... 5275.0	MHz	20	55		dB
<b>Common Mode Isolation</b> α							
	1710.0	... 1755.0	MHz	46	51		dB

**Annotation for characteristics section**

Attenuation of WCDMA signal ("Powertransferfunction",  $\alpha_{\text{WCDMA}}$ ) is determined by

$$\int_{-\infty}^{\infty} |S_{\text{ds21}}(f)H_{\text{RRC}}(f - f_{\text{Carrier}})|^2 df$$

$f_{\text{Carrier}}$  according to 3GPP TS 25.101 (e.g. for UMTS-Passband,  $f_{\text{Carrier}}$  ranges from 882.4 MHz (lowest Tx channel) to 912.6 MHz (highest Tx channel)).  $H_{\text{RRC}}(f)$  is the transfer function of the root-raised cosine transmit pulse shaping filter according to 3GPP TS 25.101 with the following normalization:

$$\int_{-\infty}^{\infty} |H_{\text{RRC}}(f)|^2 df = 1$$

**Maximum Ratings**

Storage temperature range	$T_{stg}$	-40/+85	°C	
DC voltage	$V_{DC}$	5 <sup>1)</sup>	V	
ESD voltage	$V_{ESD}$	50 <sup>2)</sup>	V	machine model, 10 pulses
Input power at	$P_{IN}$			source and load impedance 50 Ω
1710.0 ... 1755.0 MHz		29	dBm	} continuous wave 50 °C, 5.000 h
elsewhere		10	dBm	

<sup>1)</sup> 168h Damp Heat Steady State according to IEC 60068-2-67Cy

<sup>2)</sup> acc. to JESD22-A115A (machine model), 10 negative & 10 positive pulses.



**Power Transfer Function Tx-Ant:**

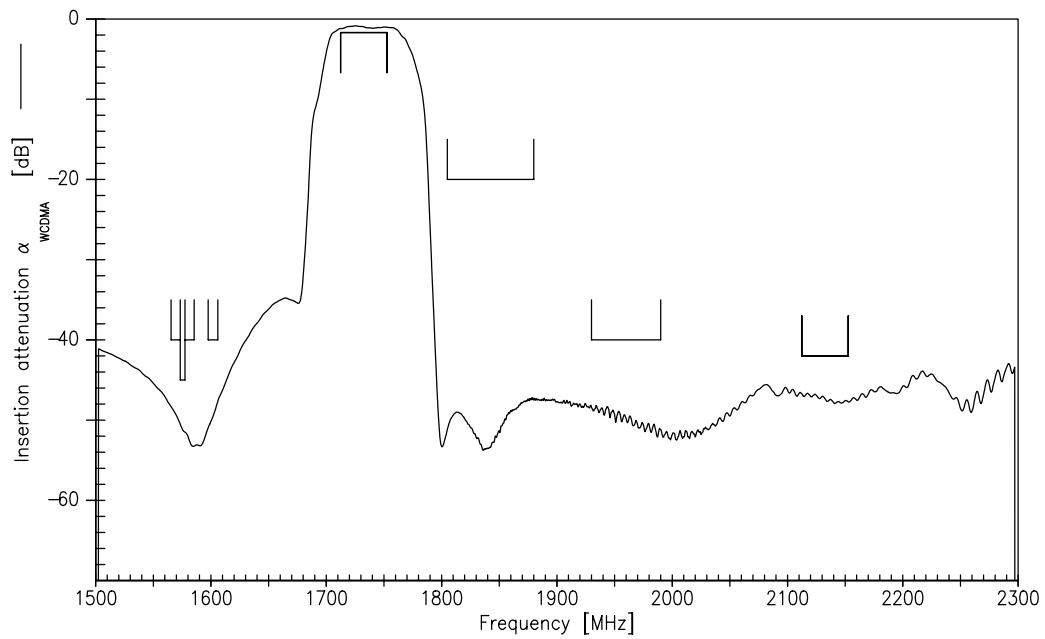

**Power Transfer Function Tx-Ant (Passband):**

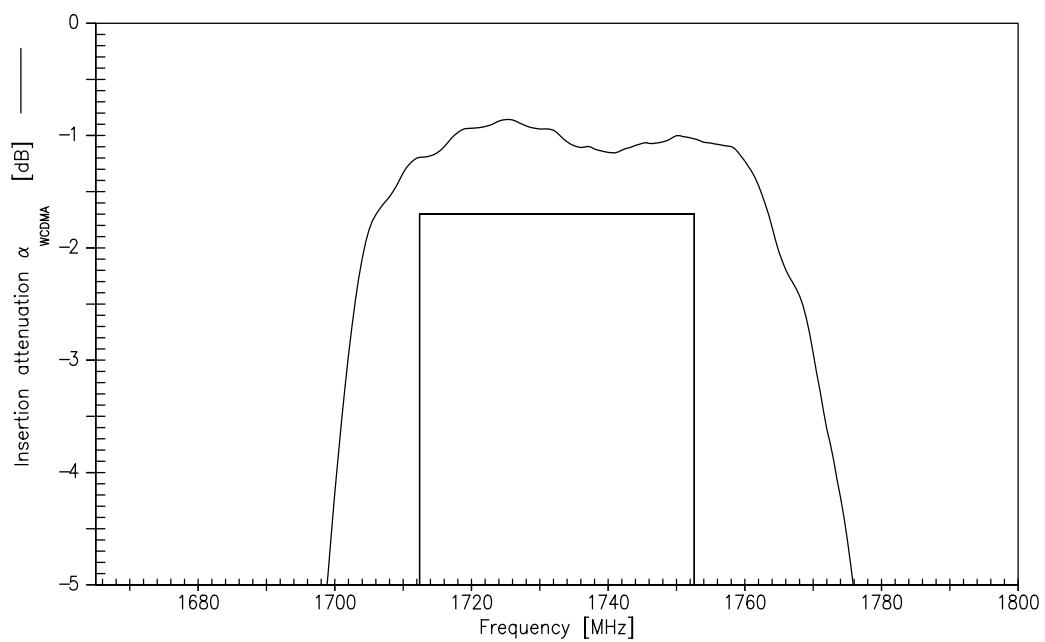



**Power Transfer Function Tx-Ant (Wideband):**

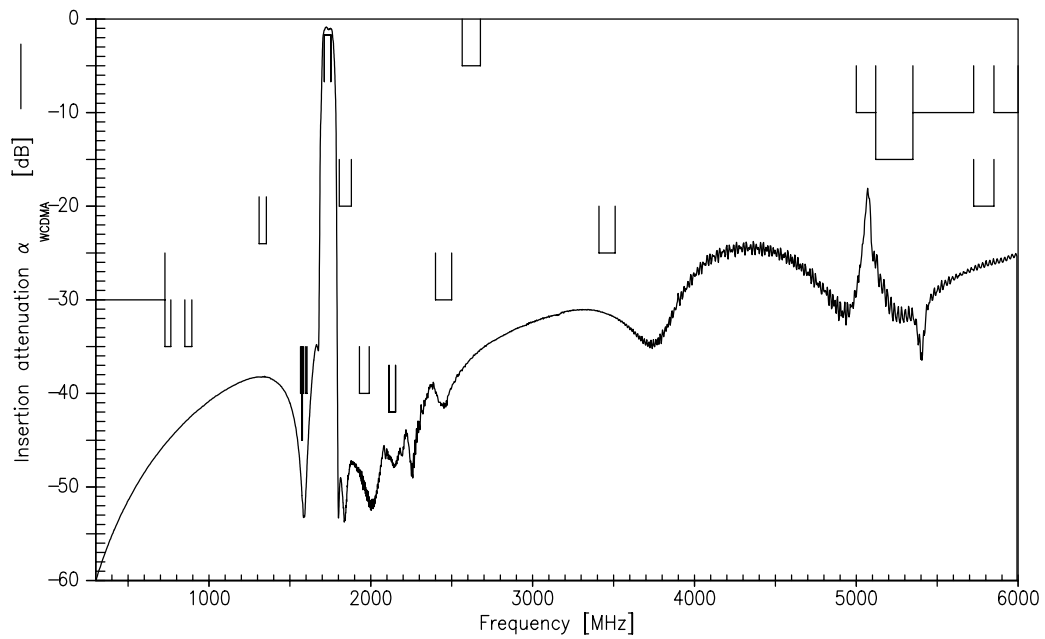

**Power Transfer Function Ant-Rx:**

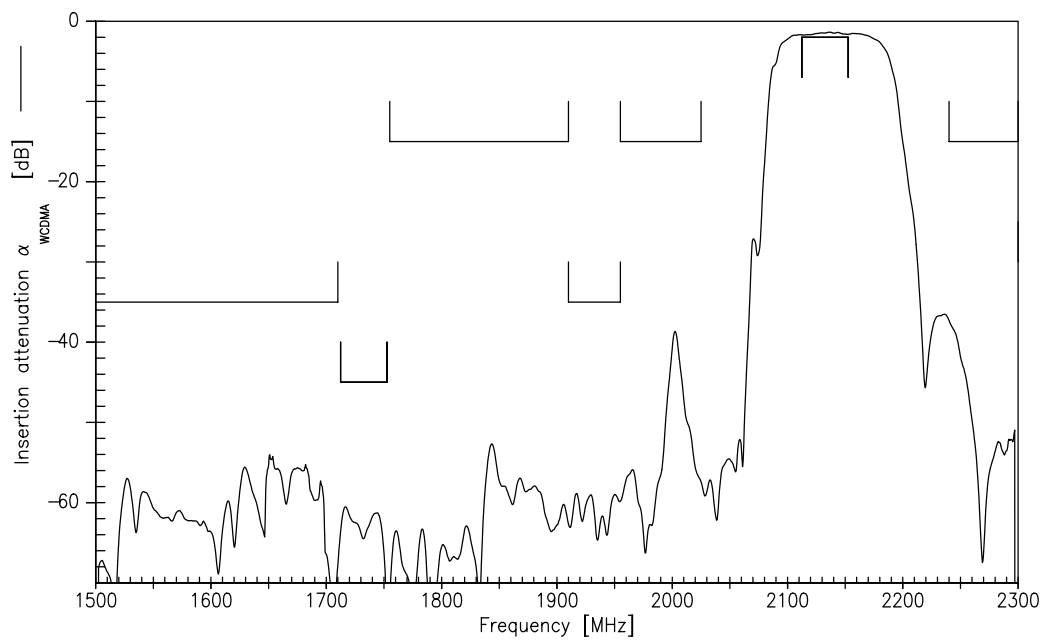

Please read *cautions and warnings and important notes* at the end of this document.



**Power Transfer Function Ant-Rx (Passband):**

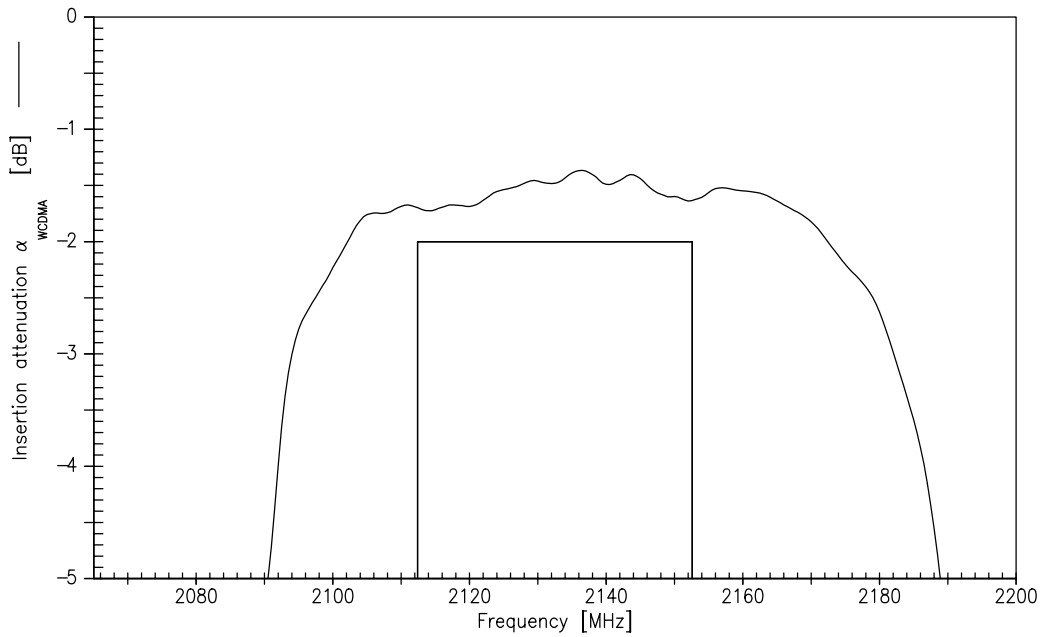

**Power Transfer Function Ant-Rx (Wideband):**

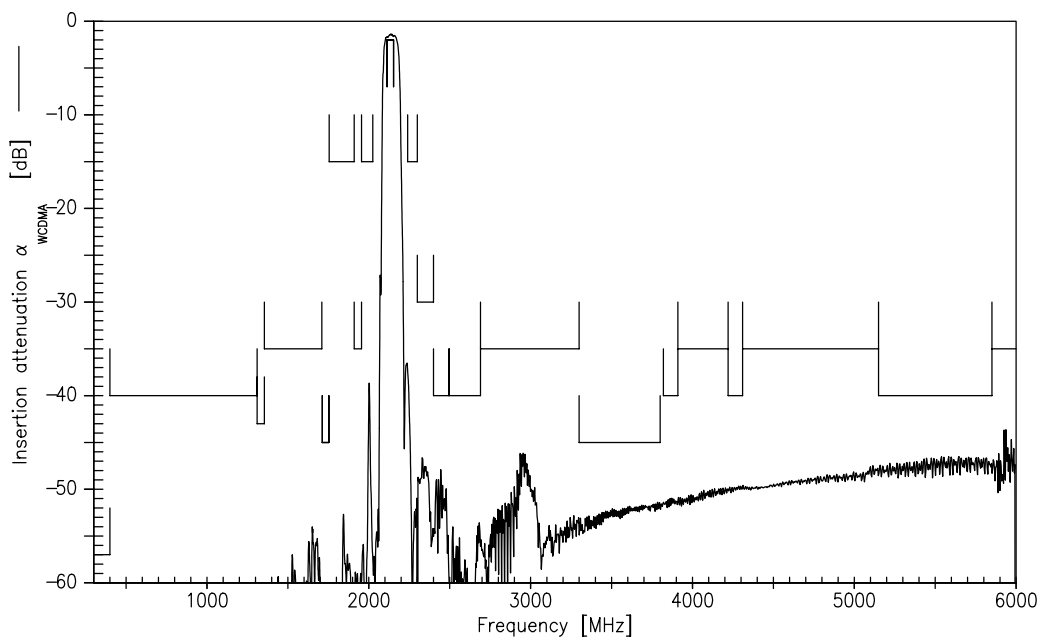

Please read *cautions and warnings* and *important notes* at the end of this document.



**Power Transfer Function Tx-Rx isolation:**

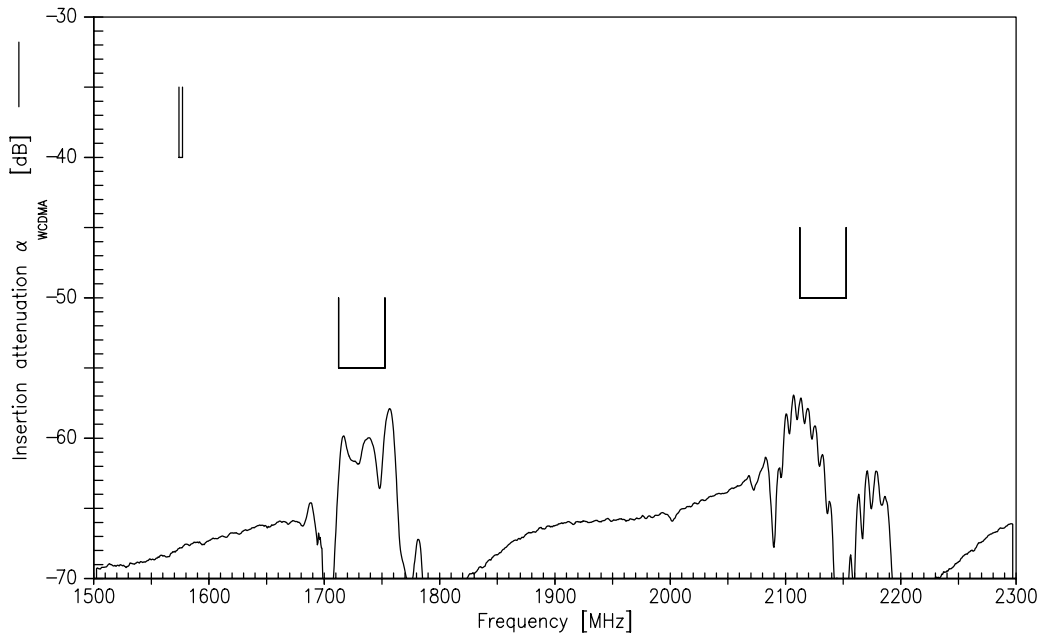

**Power Transfer Function Tx-Rx isolation (Wideband):**

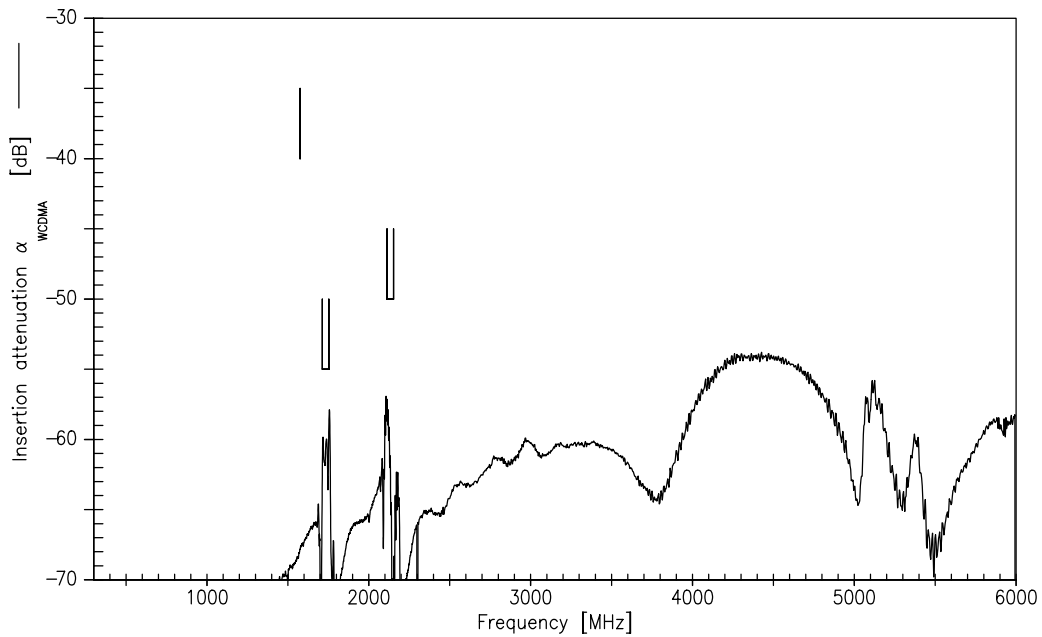



VSWRs at Tx, Rx and Ant:

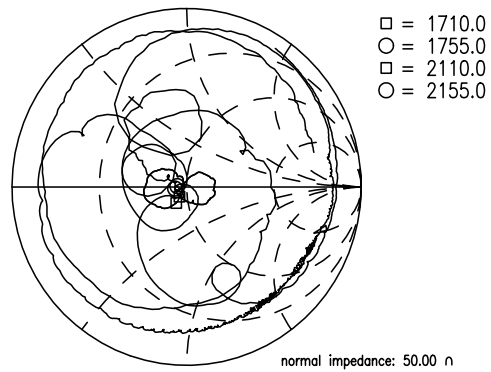
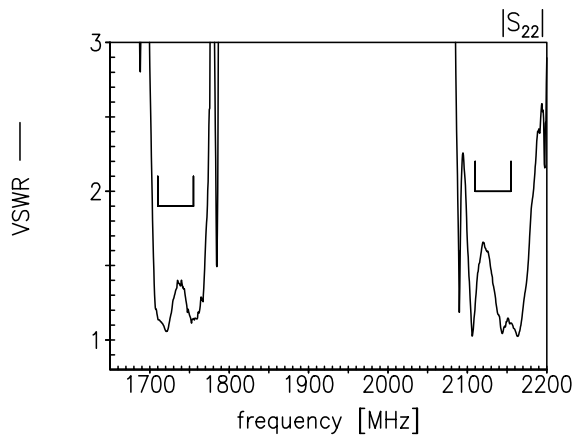
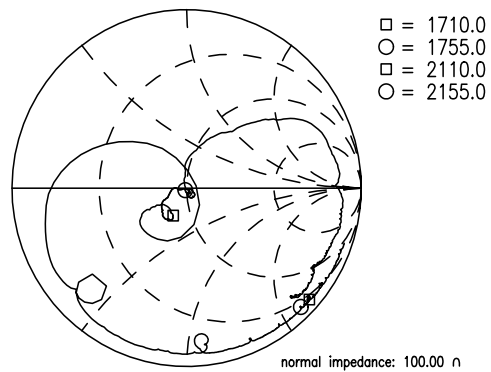
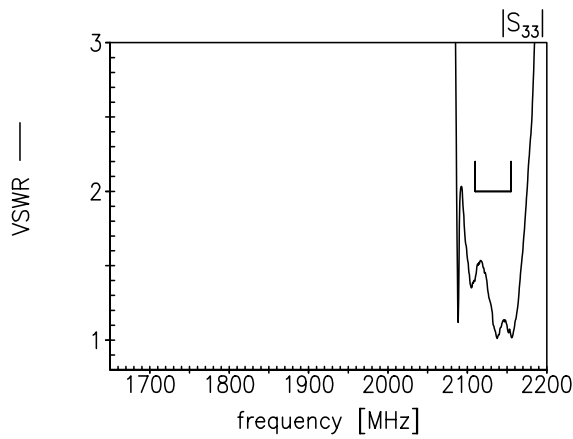
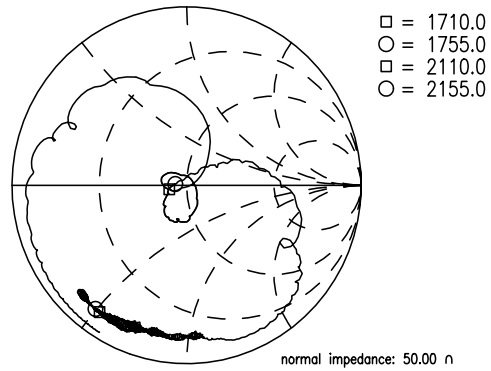
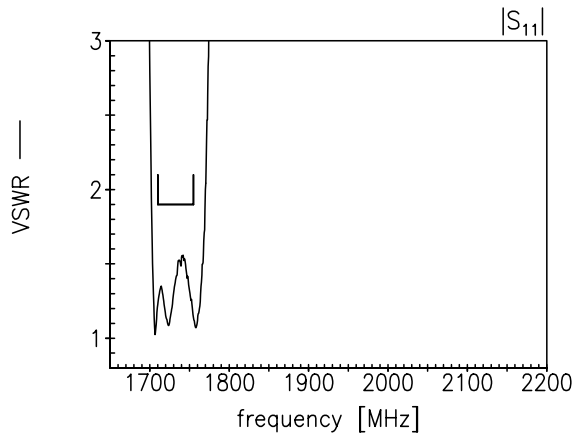



**References**

<b>Type</b>	B8524
<b>Ordering code</b>	B39212B8524P810
<b>Marking and package</b>	C61157-A8-A72-1-27
<b>Packaging</b>	F61074-V8259-Z000-2-27
<b>Date codes</b>	L_1126
<b>S-parameters</b>	B8524_NB_UN.s4p, B8524_WB_UN.s4p See file header for pin/port assignement.
<b>Soldering profile</b>	S_6001
<b>RoHS compatible</b>	defined as compatible with the following documents: "DIRECTIVE 2002/95/EC OF THE EUROPEAN PARLIAMENT AND OF THE COUNCIL of 27 January 2003 on the restriction of the use of certain hazardous substances in electrical and electronic equipment. 2005/618/EC from April 18th, 2005, amending Directive 2002/95/EC of the European Parliament and of the Council for the purposes of establishing the maximum concentration values for certain hazardous substances in electrical and electronic equipment."
<b>Moldability</b>	Before using in overmolding environment, please contact your EPCOS sales office.
<b>Matching coils</b>	See Inductor pdf-catalog <a href="http://www.tdk.co.jp/tefe02/coil.htm#aname1">http://www.tdk.co.jp/tefe02/coil.htm#aname1</a> and Data Library for circuit simulation <a href="http://www.tdk.co.jp/etvcl/index.htm">http://www.tdk.co.jp/etvcl/index.htm</a>

For further information please contact your local EPCOS sales office or visit our webpage at [www.epcos.com](http://www.epcos.com).

**Published by EPCOS AG**  
**Systems, Acoustics, Waves Business Group**  
**P.O. Box 80 17 09, 81617 Munich, GERMANY**

© EPCOS AG 2013. This brochure replaces the previous edition.

For questions on technology, prices and delivery please contact the Sales Offices of EPCOS AG or the international Representatives.

Due to technical requirements components may contain dangerous substances. For information on the type in question please also contact one of our Sales Offices.

## Important notes

The following applies to all products named in this publication:

1. Some parts of this publication contain **statements about the suitability of our products for certain areas of application**. These statements are based on our knowledge of typical requirements that are often placed on our products in the areas of application concerned. We nevertheless expressly point out **that such statements cannot be regarded as binding statements about the suitability of our products for a particular customer application**. As a rule, EPCOS is either unfamiliar with individual customer applications or less familiar with them than the customers themselves. For these reasons, it is always ultimately incumbent on the customer to check and decide whether an EPCOS product with the properties described in the product specification is suitable for use in a particular customer application.
2. We also point out that **in individual cases, a malfunction of electronic components or failure before the end of their usual service life cannot be completely ruled out in the current state of the art, even if they are operated as specified**. In customer applications requiring a very high level of operational safety and especially in customer applications in which the malfunction or failure of an electronic component could endanger human life or health (e.g. in accident prevention or life-saving systems), it must therefore be ensured by means of suitable design of the customer application or other action taken by the customer (e.g. installation of protective circuitry or redundancy) that no injury or damage is sustained by third parties in the event of malfunction or failure of an electronic component.
3. **The warnings, cautions and product-specific notes must be observed.**
4. In order to satisfy certain technical requirements, **some of the products described in this publication may contain substances subject to restrictions in certain jurisdictions (e.g. because they are classed as hazardous)**. Useful information on this will be found in our Material Data Sheets on the Internet ([www.epcos.com/material](http://www.epcos.com/material)). Should you have any more detailed questions, please contact our sales offices.
5. We constantly strive to improve our products. Consequently, **the products described in this publication may change from time to time**. The same is true of the corresponding product specifications. Please check therefore to what extent product descriptions and specifications contained in this publication are still applicable before or when you place an order. We also **reserve the right to discontinue production and delivery of products**. Consequently, we cannot guarantee that all products named in this publication will always be available. The aforementioned does not apply in the case of individual agreements deviating from the foregoing for customer-specific products.
6. Unless otherwise agreed in individual contracts, **all orders are subject to the current version of the "General Terms of Delivery for Products and Services in the Electrical Industry" published by the German Electrical and Electronics Industry Association (ZVEI)**.
7. The trade names EPCOS, BAOKE, Alu-X, CeraDiode, CeraLink, CSMP, CSSP, CTVS, DeltaCap, DigiSiMic, DSSP, FilterCap, FormFit, MiniBlue, MiniCell, MKD, MKK, MLSC, MotorCap, PCC, PhaseCap, PhaseCube, PhaseMod, PhiCap, SIFERRIT, SIFI, SIKOREL, SilverCap, SIMDAD, SiMic, SIMID, SineFormer, SIOV, SIP5D, SIP5K, ThermoFuse, WindCap are **trademarks registered or pending** in Europe and in other countries. Further information will be found on the Internet at [www.epcos.com/trademarks](http://www.epcos.com/trademarks).