

Aluminum Electrolytic, 105C, ELG, 4700 uF, 20%, 50 V, -40/+105C

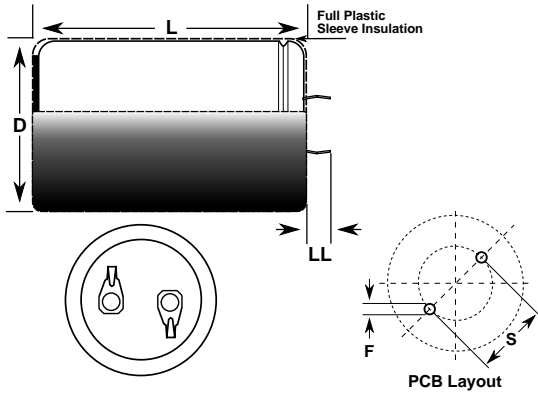

Dimensions	
D	30mm +/-1mm
L	30mm +/-2mm
S	10mm +/-0.5mm
LL	5.8mm +/-1mm
F	2mm +/-0.1mm

General Information	
Dielectric:	Aluminum Electrolytic
Series:	ELG
Description:	Snap-In, Aluminum Electrolytic
RoHS:	Yes
Lead:	2 Pin

Specifications	
Capacitance:	4700 uF
Capacitance Tolerance:	20%
Voltage DC:	50 VDC, 63 VDC (Surge)
Temperature Range:	-40/+105C
Rated Temperature:	105C
Life:	2000 Hrs
Dissipation Factor:	30% 120Hz 20C
Current:	2450 mAmps (120Hz)
Leakage:	3000 uAmps (5min 20C)

Packaging Specifications	
Packaging:	Bulk