

## DESCRIPTION

The EV020-5-S-00A Evaluation Board is designed to demonstrate the capabilities of MP020-5. The MP020-5 is a primary-side-control regulator which can eliminate secondary feedback components.

The EV020-5-S-00A is typically designed for cell phone which output 5V, 1A load from 85VAC to 265VAC, 50HZ/60HZ.

The EV020-5-S-00A has an excellent efficiency and meets IEC61000-4-5 surge immunity and EN55022 conducted EMI requirements. It has multi-protection function as open circuit protection, short-circuit protection, cycle by cycle current limit and over-temperature protection, etc.

## ELECTRICAL SPECIFICATION

Parameter	Symbol	Value	Units
Input Voltage	$V_{IN}$	85 to 265	VAC
Output Voltage	$V_{OUT}$	5	V
Output Current	$I_{OUT}$	1	A
Output Power	$P_{OUT}$	5	W
Efficiency (full load)	$\eta$	>70	%

## FEATURES

- Primary-Side–Control without Opto-Coupler or Secondary Feedback Circuit
- Precise Constant Current and Constant Voltage Control (CC/CV)
- Integrated 700V MOSFET with Minimal External Components
- Variable, Off-Time, Peak-Current Control
- 550 $\mu$ A High-Voltage Current Source
- 30mW No-Load Power Consumption
- Programmable Cable Compensation
- Multiple Protections: OVP, OCP, OCKP, OTP, and VCC UVLO
- Natural Spectrum Shaping for Improved EMI Signature
- Low Cost and Simple External circuit

## APPLICATIONS

- Cell Phone Chargers
- Adapters for Handheld Electronics
- Stand-By and Auxiliary Power Supplies
- Small Appliances

All MPS parts are lead-free and adhere to the RoHS directive. For MPS green status, please visit MPS website under Quality Assurance. "MPS" and "The Future of Analog IC Technology", are Registered Trademarks of Monolithic Power Systems, Inc.



**Warning:** Although this board is designed to satisfy safety requirements, the engineering prototype has not been agency approved. Therefore, all testing should be performed using an isolation transformer to provide the AC input to the prototype board.

**EV020-5-S-00A EVALUATION BOARD**

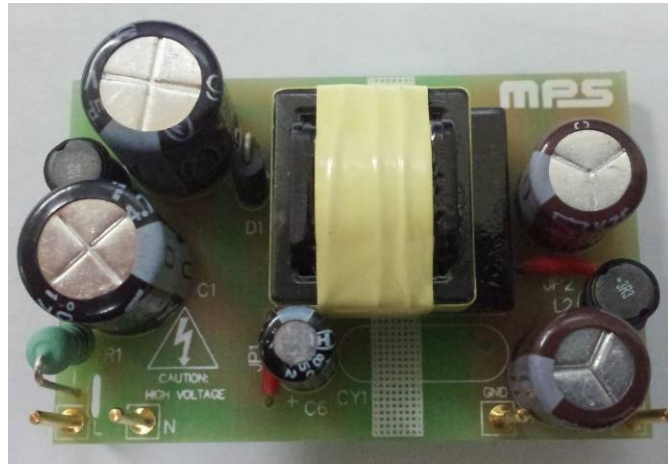

**TOP VIEW**



**BOTTOM VIEW**

(L x W x H) 47mm x 30mm x 18mm

Board Number	MPS IC Number
EV020-5-S-00A	MP020-5GS





## CIRCUIT DESCRIPTION

The EV020-5-S-00A is configured in a single-stage Flyback topology, it uses primary-side-control which can mostly simplify the schematic and get a cost effective BOM. It can also achieve accurate constant voltage and constant current.

FR1 and CR1 compose the input stage. FR1 is used to protect for the component failure or some excessive short events, also it can restrain the inrush current.

C1, L1 and C2 compose  $\pi$  filter to guarantee the conducted EMI meet standard EN55022. R2, R3, D1 and C3 compose the snubber circuit to reduce drain-source voltage spike.

R4, C5, C6 and D2 are used as Vcc power supply.

R5 and R6 are resistor divider for detecting output voltage by sampling voltage on primary auxiliary winding.

CY1 is Y capacitor lowering common mode noise to make sure there is enough EMI margin. T1 is power transformer, the structure of which is also very important to pass EMI test.

D3, C8, C9, C10, L2 and R8 compose output circuit. D3 is schottky diode for better efficiency. C10 is ceramic capacitor for lower output voltage ripple and R8 is dummy load, which is used for good regulation. C8, L2 and C9 compose  $\pi$  filter to restrain the output ripple.

R7 and C7 are used to depress the spike of schottky.

**EV020-5-S-00A BILL OF MATERIALS**

Qty	Ref	Value	Description	Package	Manufacturer	Manufacturer_P/N
1	C1	4.7 $\mu$ F	Capacitor;400V;20%	DIP	Nichicon	UVY2G4R7MPD
1	C2	10 $\mu$ F	Capacitor;400V;20%	DIP	Ltec	TY 10uF/400V
1	C3	1nF	Ceramic Capacitor;630V;X7R	1206	Murata	GRM31A7U2J102JW31D
1	C4	1 $\mu$ F	Ceramic Capacitor;25V;X7R;	0603	Murata	GRM188R71E105KA12D
1	C5	100nF	Ceramic Capacitor;50V;X7R;	0603	Murata	GCJ188R71H104KA12D
1	C6	22 $\mu$ F	Electrolytic Capacitor;50V	DIP	Jianghai	CD281L-50V22
1	C7	1.2nF	Ceramic Capacitor;100V;X7R	0603	muRata	GRM188R72A122KA01D
2	C8,C9	470 $\mu$ F	Electrolytic Capacitor;10V,Low ESR	DIP	Nippon Chemi-con	EKZE100ELL471MHB5D
1	C10	1 $\mu$ F	Ceramic Capacitor;10V;X7R	0603	Murata	GRM188R71A105KA61D
1	C11	22pF	Ceramic Capacitor;50V;C0G;	0603	Murata	GRM1885C1H220JA01D
1	CY1	NC				
1	CR1	MB6F	Diode;600V;0.5A	SOP-4	Diodes	MB6F
1	D1	FR107	Diode;1000V;1A	DO-41	Diodes	FR107
1	D2	S1ML	Diode;1000V;1A;	SMA	Taiwan Semiconductor	S1ML
1	D3	B540C	Schottky Diode;40V;5A	SMC	Diodes	B540C
1	FR1	10 $\Omega$	Fusible Resistor, 1 W, 5%	Yageo	DIP	FKN1WSJT-52-10R
1	L1	1000 $\mu$ H	Inductor;1000uH;6 Ohm;0.25A	DIP	Wurth	7447462102
1	L2	3.3 $\mu$ H	Inductor;3.3uH;0.025Ohm;4A	DIP	Wurth	7447462033
1	R1	10k $\Omega$	Film Resistor;5%	0805	Yageo	RC0805JR-0710KL
1	R2	357 $\Omega$	Film Resistor; 1%;1/4W	1206	Yageo	RC1206FR-07357RL
1	R3	150k $\Omega$	Film Resistor; 1%,1/4W	1206	Panasonic	ERJ8ENF1503V
1	R4	10 $\Omega$	Film Resistor;5%;1/4W	1206	Yageo	RC1206JR-0710R
1	R5	27k $\Omega$	Film Resistor;1%;	0603	Yageo	RC0603FR-0727KL
1	R6	13.3k $\Omega$	Film Resistor;1%	0603	Yageo	RC0603FR-0713K3L
1	R7	20 $\Omega$	Film Resistor;5%;1/4W	1206	Royalohm	1206J0200T5E
1	R8	2.2k $\Omega$	Film Resistor;5%;	0603	LIZ	RC0603JA0222G
1	R9	510 $\Omega$	Film Resistor;5%;	0805	LIZ	RC0805JA0510
1	U1		Primary side regulator R3	SOIC8-7A	MPS	MP020-5GS
1	T1		Transformer;1.6mH; N <sub>P</sub> :N <sub>P_AU</sub> :N <sub>SEC1</sub> :N <sub>SEC2</sub> =127:18:4:4	EE16	Wurth <sup>(1)</sup>	7508110157
<b>Notes:</b>		(1) Wurth transformer sample request please login on website: <a href="http://www.we-online.com">www.we-online.com</a>				

## TRANSFORMER SPECIFICATION

### Electrical Diagram

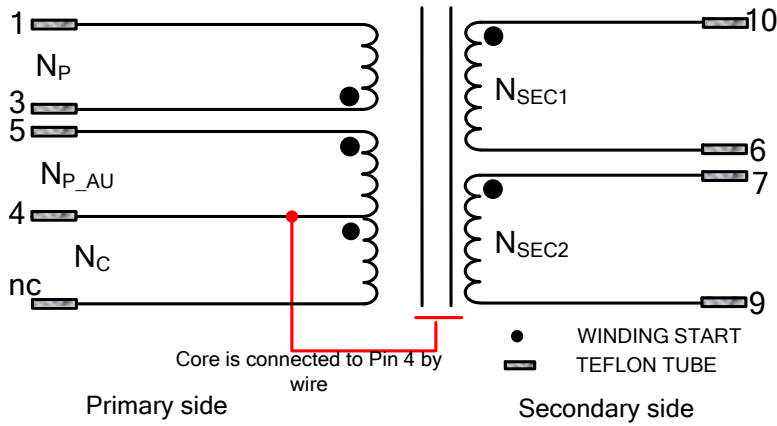

Figure 4—Transformer Electrical Diagram

**Notes:**

1.  $N_{SEC1}$  and  $N_{SEC2}$  are coiled at one layer.
2. Core is connected to Pin 4 with naked wire.
3.  $N_{SEC1}$  and  $N_{SEC2}$  are with Triple Insulation Wire.

### Winding Diagram

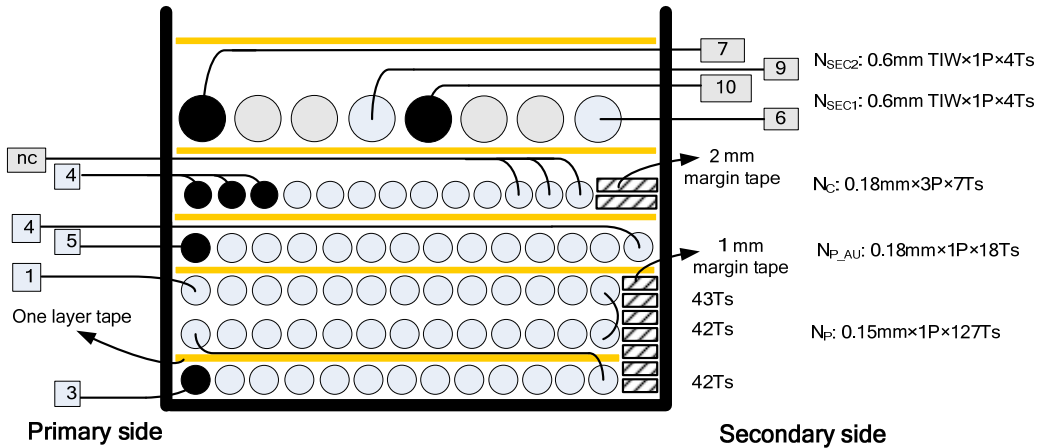

Figure 5—Winding Diagram

### Winding Order

Winding No.	Tape Layer Number	Start & End	Magnet Wire $\Phi$ (mm)	Turns
N <sub>P</sub>	1	3→1	0.15mm * 1	127
N <sub>P_AU</sub>	1	5→4	0.18mm * 1	18
N <sub>C</sub>	1	4→nc	0.18mm * 3	7
N <sub>SEC1</sub>	1	10→6	0.6mm * 1 TIW	4
N <sub>SEC2</sub>	1	7→9	0.6mm * 1 TIW	4

### Electrical Specifications

<b>Electrical Strength</b>	60 second, 60Hz, from PRI. to SEC.	3000VAC
	60 second, 60Hz, from PRI. to CORE.	500VAC
	60 second, 60Hz, from SEC. to CORE.	3000VAC
<b>Primary Inductance</b>	Pins 1 - 3, all other windings open, measured at 60kHz, 0.1 VRMS	1.6mH±10%
<b>Primary Leakage Inductance</b>	Pins 1 - 3 with all other pins shorted, measured at 60kHz. 0.1 VRMS	50µH±10%

### Materials

Item	Description
1	Core: EE16, UI=2300±25%, AL=73.2.4nH/N <sup>2</sup> ±3% GAPPED, or equivalent
2	Bobbin: EE16, 5+5PIN 1 SECT TH, UL94V-0
3	Wire: $\Phi$ 0.15mm,, 2UEW, Class B
4	Wire: $\Phi$ 0.18mm,, 2UEW, Class B
5	Triple Insulation Wire: $\Phi$ 0.60mm TIW
6	Tape: 8.0mm(W)×0.06mm(TH)
7	Varnish: JOHN C. DOLPH CO, BC-346A or equivalent
8	Solder Bar: CHEN NAN: SN99.5/Cu0.5 or equivalent



## EVB TEST RESULTS

### Performance Data

$T_A=25^{\circ}\text{C}$ , unless otherwise noted.

#### Efficiency

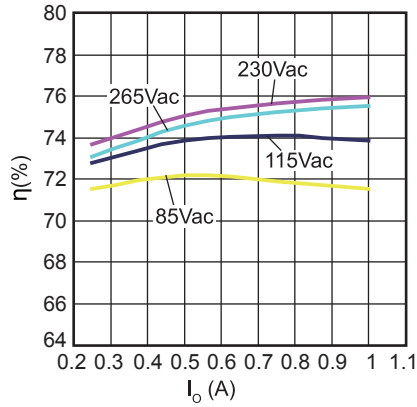

#### No Load Consumption

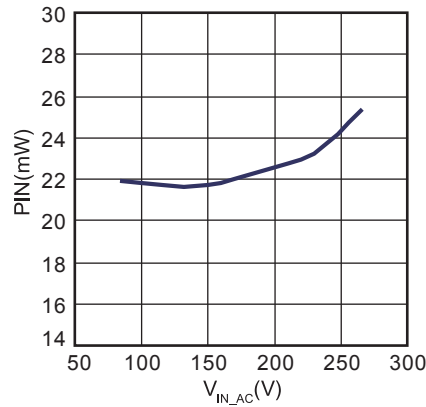

#### Line Regulation

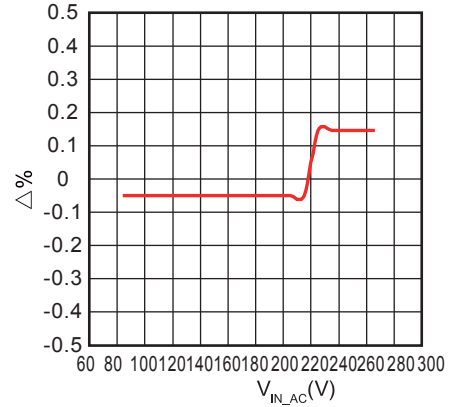

#### CV/CC

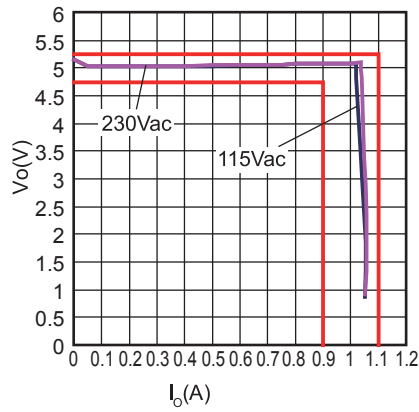

**Electric Strength Test**

Primary circuit to secondary circuit electric strength testing was completed according to IEC61000-4-2.

Input and output was shorted respectively. 3000VAC/50Hz sine wave applied between input and output for 1min, and operation was verified.

**Surge Test**

Line to Line 1kV and Line to Power Earth 1kV surge testing was completed according to IEC61000-4-5. Input voltage was set at 220VAC/50Hz. Output was loaded at full load and operation was verified following each surge event.

Surge Level (V)	Input Voltage (VAC)	Injection Location	Injection Phase (°)	Test Result (Pass/Fail)
1000	220	L to N	90	Pass
-1000	220	L to N	270	Pass
1000	220	L to PE	90	Pass
-1000	220	L to PE	270	Pass
1000	220	N to PE	90	Pass
-1000	220	N to PE	270	Pass

Conducted EMI Test

Test with 230Vac input and full load condition

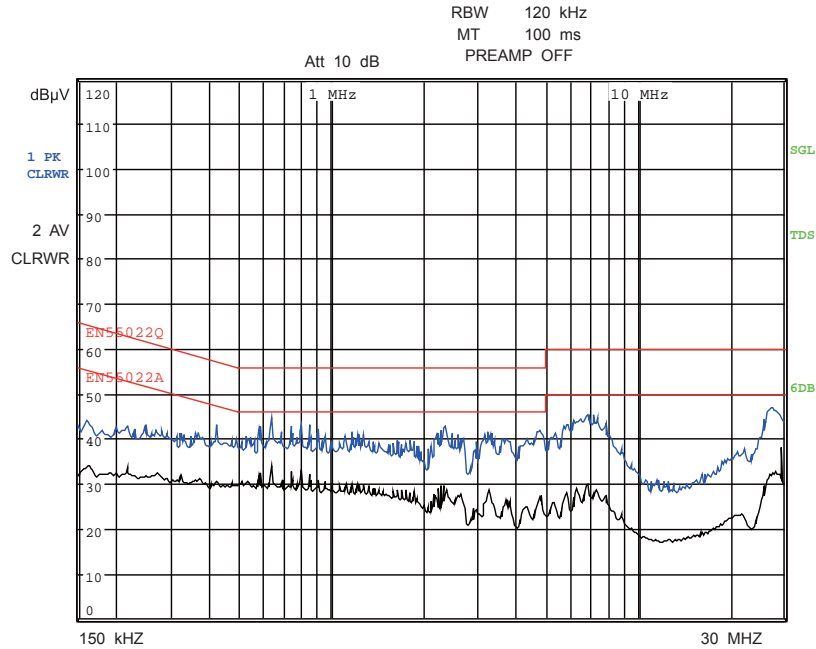

230Vac, 50Hz, Maximum Load, L Line, Output GND floats, EN55022 Limits

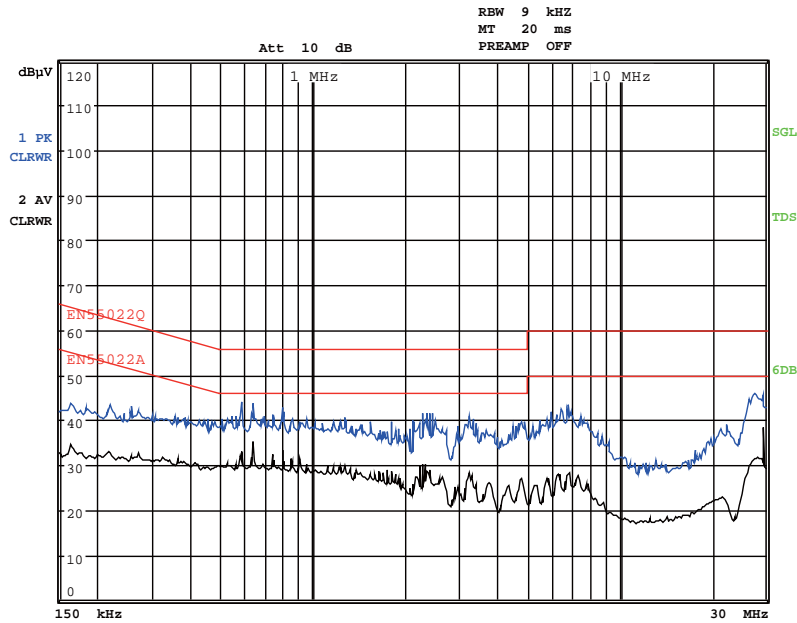

230Vac, 50Hz, Maximum Load, N Line, Output GND floats, EN55022 Limits

Conducted EMI Test (continued)

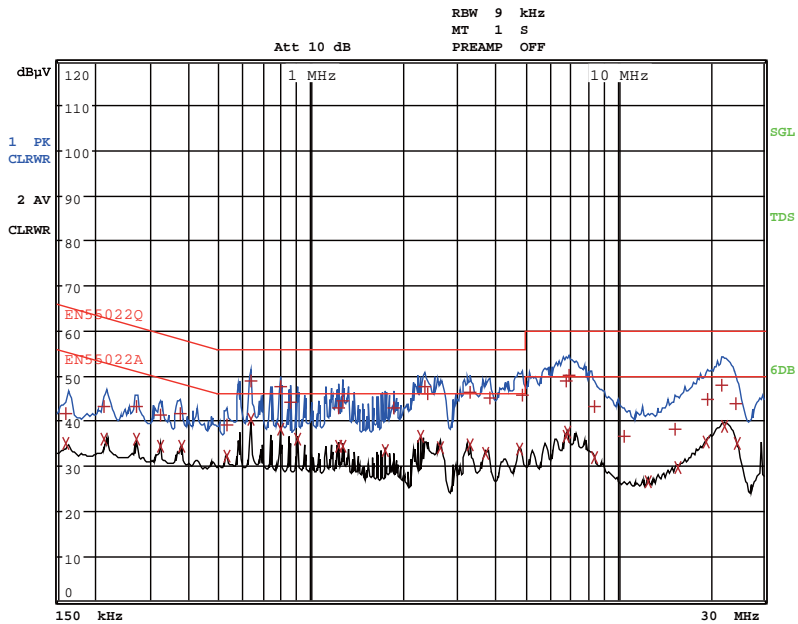

230Vac, 50Hz, Maximum Load, L Line, Output GND connects to Earth, EN55022 Limits

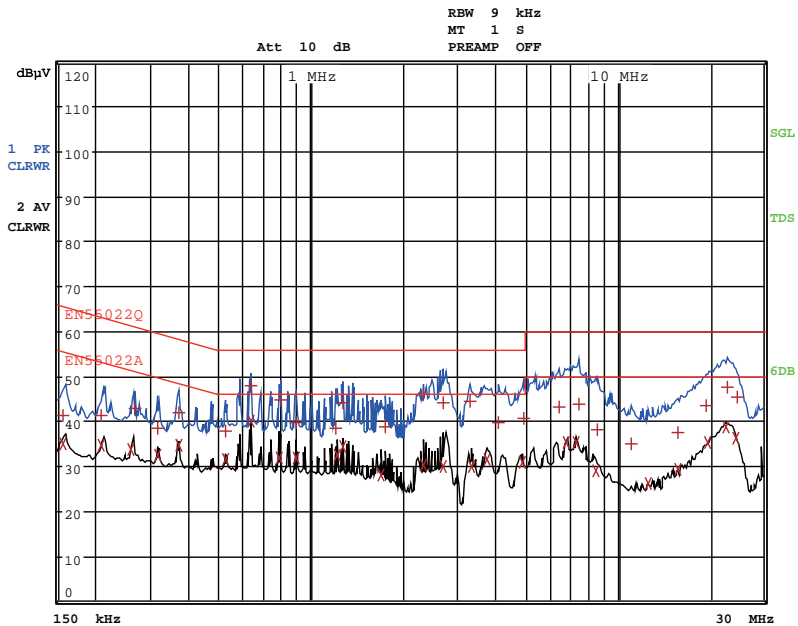

230Vac, 50Hz, Maximum Load, N Line, Output GND connects to Earth, EN55022 Limits

**Thermal Test**

Test with 85Vac input and full load condition. PCB layout is with 10oz copper. Ambient temperature is 25°C.

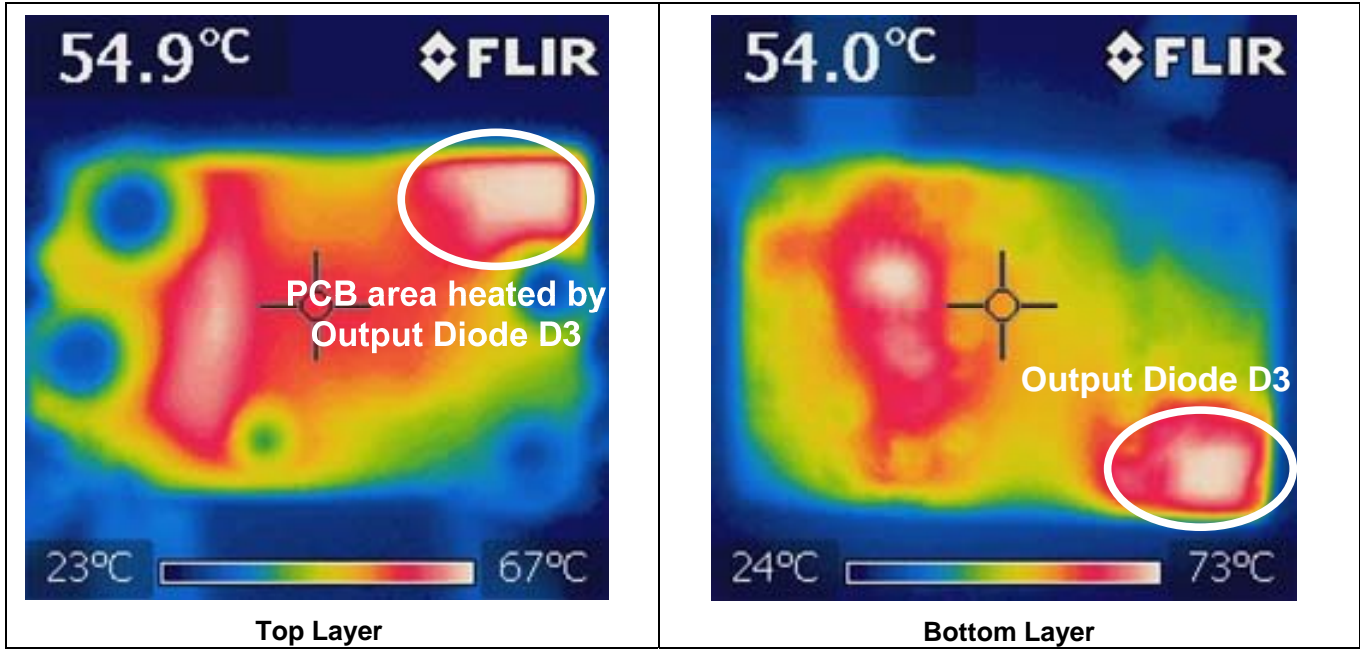

## EVB TEST RESULTS

Performance waveforms are tested on the evaluation board.

$V_{IN}=115VAC/60Hz$ ,  $V_{OUT}=5V$ ,  $I_{OUT}=1A$ ,  $L_P=1.6mH$ ,  $N_P:N_{P\_AU}:N_{SEC1}:N_{SEC2}=127:18:4:4$ ,  $T_A=25^{\circ}C$ , unless otherwise noted.

Steady State

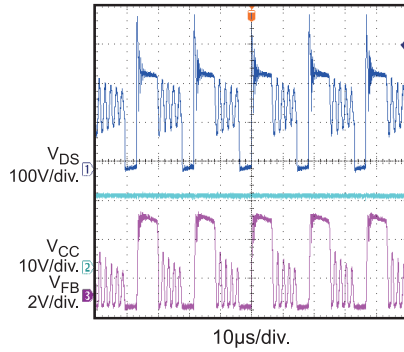

Turn On Delay

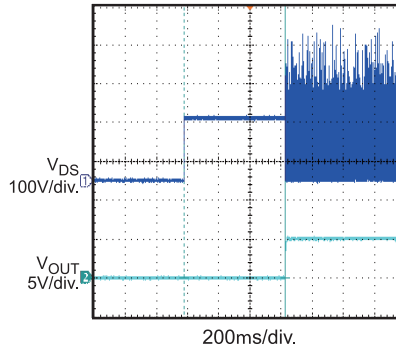

Output Rise Time

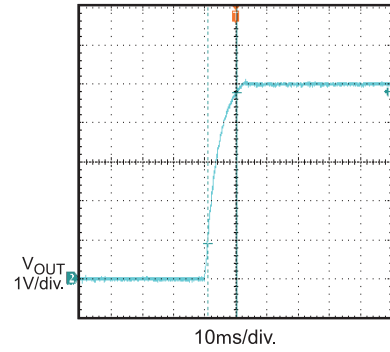

Output Ripple

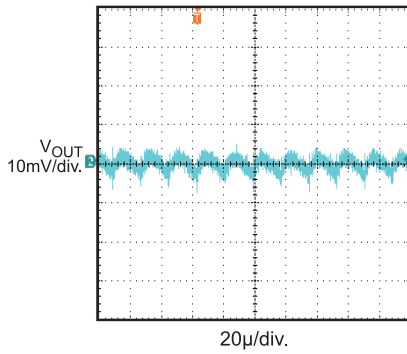

SCP Enter

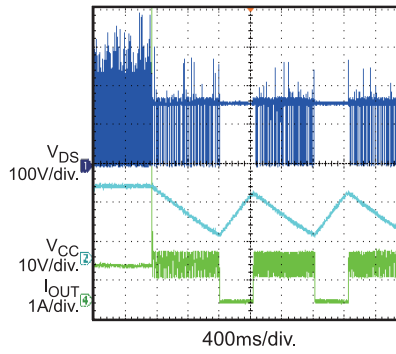

SCP Recovery

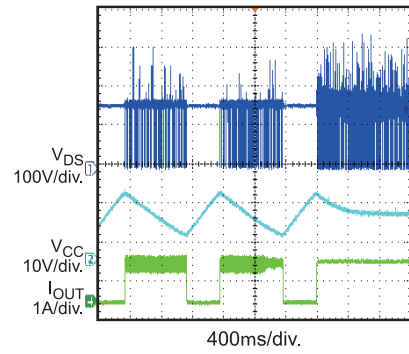

OckP Enter

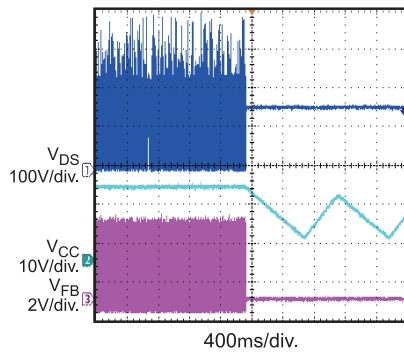

OckP Recovery

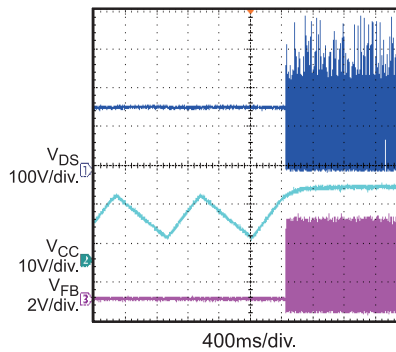

Load Transient

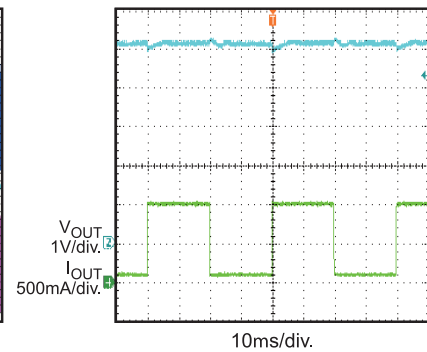

## EVB TEST RESULTS *(continued)*

Performance waveforms are tested on the evaluation board.

$V_{IN}=230VAC/50Hz$ ,  $V_{OUT}=5V$ ,  $I_{OUT}=1A$ ,  $L_P=1.6mH$ ,  $N_P:N_{P\_AU}:N_{SEC1}:N_{SEC2}=127:18:4:4$ ,  $T_A=25^\circ C$ , unless otherwise noted.

Steady State

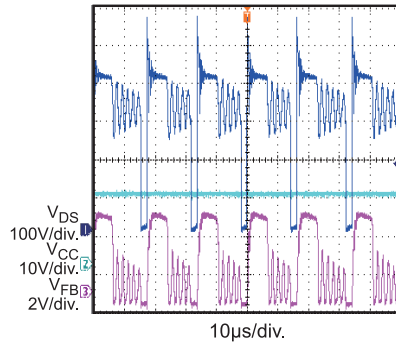

Turn On Delay

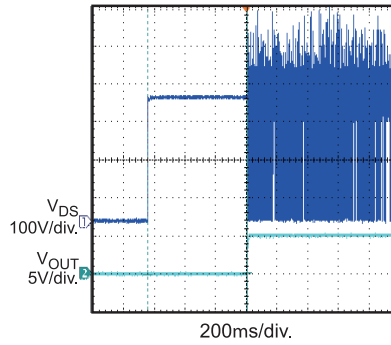

Output Rise Time

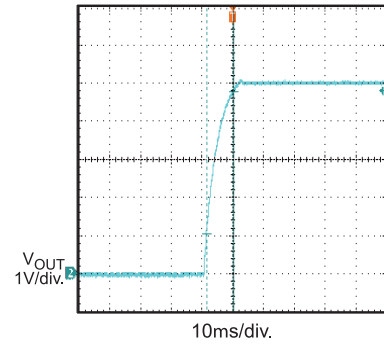

Output Ripple

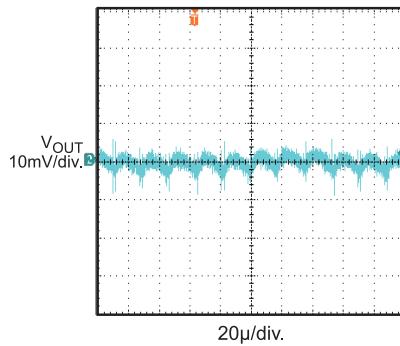

SCP Enter

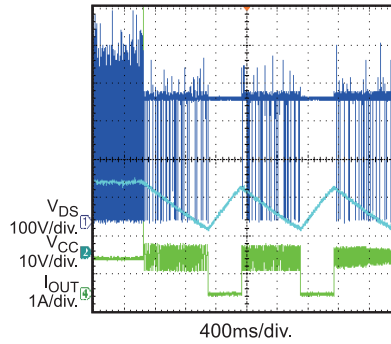

SCP Recovery

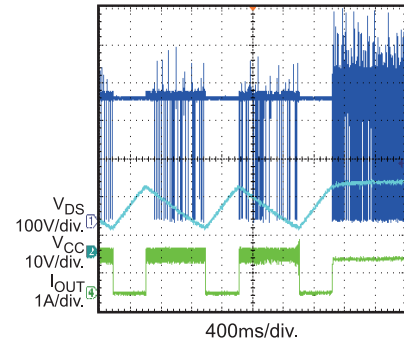

OCP Enter

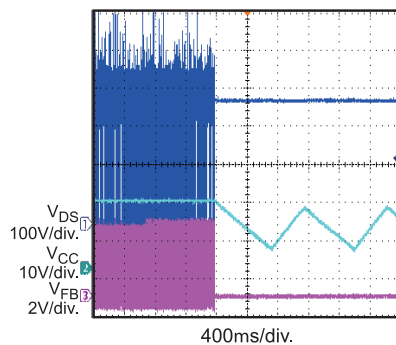

OCP Recovery

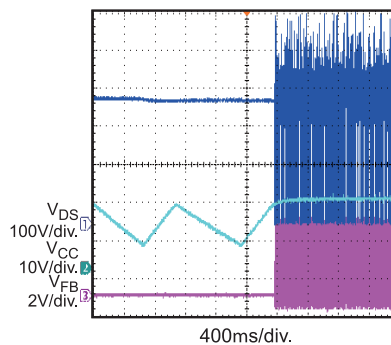

Load Transient

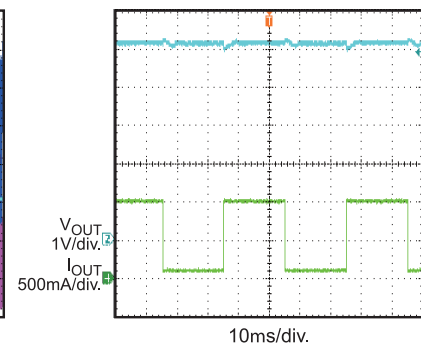

## QUICK START GUIDE

1. Preset Power Supply to  $85\text{VAC} \leq V_{\text{IN}} \leq 265\text{VAC}$ .
2. Turn Power Supply off.
3. Connect the Line and Neutral terminals of the power supply output to L and N port. For three-wire input application, make OUTPUT GND connected to Earth.
4. Connect Load to:
  - a. Positive (+): VOUT
  - b. Negative (-): GND
5. Turn Power Supply on after making connections.

**NOTICE:** The information in this document is subject to change without notice. Please contact MPS for current specifications. Users should warrant and guarantee that third party Intellectual Property rights are not infringed upon when integrating MPS products into any application. MPS will not assume any legal responsibility for any said applications.