

FDFS2P103

Integrated P-Channel PowerTrench® MOSFET and Schottky Diode

General Description

The FDFS2P103 combines the exceptional performance of Fairchild's PowerTrench MOSFET technology with a very low forward voltage drop Schottky barrier rectifier in an SO-8 package.

This device is designed specifically as a single package solution for DC to DC converters. It features a fast switching, low gate charge MOSFET with very low on-state resistance. The independently connected Schottky diode allows its use in a variety of DC/DC converter topologies.

Features

- -5.3 A, -30V $R_{DS(ON)} = 59 \text{ m}\Omega @ V_{GS} = -10 \text{ V}$
 $R_{DS(ON)} = 92 \text{ m}\Omega @ V_{GS} = -4.5 \text{ V}$
- $V_F < 0.52 \text{ V @ 1 A (} T_J = 125^\circ\text{C)}$
 $V_F < 0.57 \text{ V @ 1 A (} T_J = 25^\circ\text{C)}$
- Schottky and MOSFET incorporated into single power surface mount SO-8 package
- Electrically independent Schottky and MOSFET pinout for design flexibility

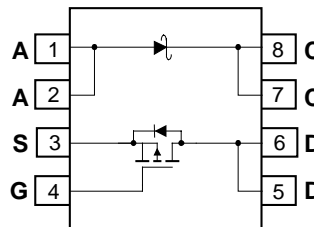
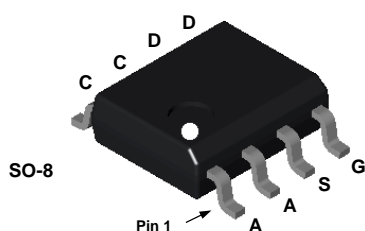

Absolute Maximum Ratings T_A=25°C unless otherwise noted

| Symbol | Parameter | Ratings | Units |
|-----------------------------------|--|-------------|-------|
| V _{DSS} | MOSFET Drain-Source Voltage | -30 | V |
| V _{GSS} | MOSFET Gate-Source Voltage | ±25 | V |
| I _D | Drain Current – Continuous (Note 1a) | -5.3 | A |
| | – Pulsed | -20 | |
| P _D | Power Dissipation for Dual Operation | 2 | W |
| | Power Dissipation for Single Operation (Note 1a) | 1.6 | |
| | (Note 1b) | 1 | |
| | (Note 1c) | 0.9 | |
| T _J , T _{STG} | Operating and Storage Junction Temperature Range | -55 to +150 | °C |
| V _{RRM} | Schottky Repetitive Peak Reverse Voltage | 30 | V |
| I _O | Schottky Average Forward Current (Note 1a) | 1 | A |

Package Marking and Ordering Information

| Device Marking | Device | Reel Size | Tape width | Quantity |
|----------------|-----------|-----------|------------|------------|
| FDFS2P103 | FDFS2P103 | 13" | 12mm | 2500 units |

Electrical Characteristics

$T_A = 25^\circ\text{C}$ unless otherwise noted

| Symbol | Parameter | Test Conditions | Min | Typ | Max | Units |
|--------|-----------|-----------------|-----|-----|-----|-------|
|--------|-----------|-----------------|-----|-----|-----|-------|

Off Characteristics

| | | | | | | |
|--------------------------------------|---|--|-----|-----|------|----------------------|
| BV_{DSS} | Drain–Source Breakdown Voltage | $V_{GS} = 0\text{ V}, I_D = -250\ \mu\text{A}$ | -30 | | | V |
| $\frac{\Delta BV_{DSS}}{\Delta T_J}$ | Breakdown Voltage Temperature Coefficient | $I_D = -250\ \mu\text{A}$, Referenced to 25°C | | -23 | | mV/ $^\circ\text{C}$ |
| I_{DSS} | Zero Gate Voltage Drain Current | $V_{DS} = -24\text{ V}, V_{GS} = 0\text{ V}$ | | | -1 | μA |
| I_{GSSF} | Gate–Body Leakage, Forward | $V_{GS} = 25\text{ V}, V_{DS} = 0\text{ V}$ | | | 100 | nA |
| I_{GSSR} | Gate–Body Leakage, Reverse | $V_{GS} = -25\text{ V}, V_{DS} = 0\text{ V}$ | | | -100 | nA |

On Characteristics (Note 2)

| | | | | | | |
|--|--|--|-----|----------------|----------------|----------------------|
| $V_{GS(th)}$ | Gate Threshold Voltage | $V_{DS} = V_{GS}, I_D = -250\ \mu\text{A}$ | -1 | -1.7 | -3 | V |
| $\frac{\Delta V_{GS(th)}}{\Delta T_J}$ | Gate Threshold Voltage Temperature Coefficient | $I_D = -250\ \mu\text{A}$, Referenced to 25°C | | 4.5 | | mV/ $^\circ\text{C}$ |
| $R_{DS(on)}$ | Static Drain–Source On–Resistance | $V_{GS} = -10\text{ V}, I_D = -5.3\text{ A}$ $V_{GS} = -4.5\text{ V}, I_D = -4\text{ A}$ $V_{GS} = -10\text{ V}, I_D = -5.3\text{ A}, T_J = 125^\circ\text{C}$ | | 46 70 63 | 59 92 88 | m Ω |
| $I_{D(on)}$ | On–State Drain Current | $V_{GS} = -10\text{ V}, V_{DS} = -5\text{ V}$ | -20 | | | A |
| g_{FS} | Forward Transconductance | $V_{DS} = -5\text{ V}, I_D = -5.3\text{ A}$ | | 10 | | S |

Dynamic Characteristics

| | | | | | | |
|------------|------------------------------|---|--|-----|--|----|
| C_{iss} | Input Capacitance | $V_{DS} = -15\text{ V}, V_{GS} = 0\text{ V},$ $f = 1.0\text{ MHz}$ | | 528 | | pF |
| C_{oss} | Output Capacitance | | | 132 | | pF |
| C_{riss} | Reverse Transfer Capacitance | | | 70 | | pF |

Switching Characteristics (Note 2)

| | | | | | | |
|--------------|---------------------|---|--|-----|----|----|
| $t_{d(on)}$ | Turn–On Delay Time | $V_{DD} = -15\text{ V}, I_D = -1\text{ A},$ $V_{GS} = -10\text{ V}, R_{GEN} = 6\ \Omega$ | | 7 | 14 | ns |
| t_r | Turn–On Rise Time | | | 13 | 24 | ns |
| $t_{d(off)}$ | Turn–Off Delay Time | | | 14 | 25 | ns |
| t_f | Turn–Off Fall Time | | | 9 | 17 | ns |
| Q_g | Total Gate Charge | $V_{DS} = -15\text{ V}, I_D = -5.3\text{ A},$ $V_{GS} = -5\text{ V}$ | | 5.3 | 8 | nC |
| Q_{gs} | Gate–Source Charge | | | 2.2 | | nC |
| Q_{gd} | Gate–Drain Charge | | | 1.6 | | nC |

Drain–Source Diode Characteristics and Maximum Ratings

| | | | | | | |
|----------|---|---|--|------|------|---|
| I_S | Maximum Continuous Drain–Source Diode Forward Current | | | | -1.3 | A |
| V_{SD} | Drain–Source Diode Forward Voltage | $V_{GS} = 0\text{ V}, I_S = -1.3\text{ A}$ (Note 2) | | -0.7 | -1.2 | V |

Schottky Diode Characteristics

| | | | | | | |
|-------|-----------------|---------------------|---------------------------|------|------|---------------|
| I_R | Reverse Leakage | $V_R = 30\text{ V}$ | $T_J = 25^\circ\text{C}$ | 15 | 100 | μA |
| | | | $T_J = 125^\circ\text{C}$ | 6 | 30 | mA |
| V_F | Forward Voltage | $I_F = 1\text{ A}$ | $T_J = 25^\circ\text{C}$ | 0.41 | 0.57 | V |
| | | | $T_J = 125^\circ\text{C}$ | 0.32 | 0.52 | V |

Thermal Characteristics

| | | | | |
|-----------------|---|-----------|-----|-----------------------------|
| $R_{\theta JA}$ | Thermal Resistance, Junction-to-Ambient | (Note 1a) | 78 | $^{\circ}\text{C}/\text{W}$ |
| $R_{\theta JA}$ | Thermal Resistance, Junction-to-Ambient | (Note 1c) | 135 | $^{\circ}\text{C}/\text{W}$ |
| $R_{\theta JC}$ | Thermal Resistance, Junction-to-Case | (Note 1) | 40 | $^{\circ}\text{C}/\text{W}$ |

Notes:

1. $R_{\theta JA}$ is the sum of the junction-to-case and case-to-ambient thermal resistance where the case thermal reference is defined as the solder mounting surface of the drain pins. $R_{\theta JC}$ is guaranteed by design while $R_{\theta CA}$ is determined by the user's board design.

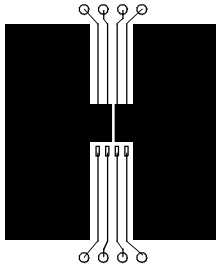

a) 78 $^{\circ}\text{C}/\text{W}$ when mounted on a 0.5in² pad of 2 oz copper

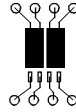

b) 125 $^{\circ}\text{C}/\text{W}$ when mounted on a 0.02 in² pad of 2 oz copper

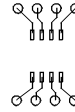

c) 135 $^{\circ}\text{C}/\text{W}$ when mounted on a minimum pad.

Scale 1 : 1 on letter size paper

2. Pulse Test: Pulse Width < 300 μs , Duty Cycle < 2.0%

Typical Characteristics

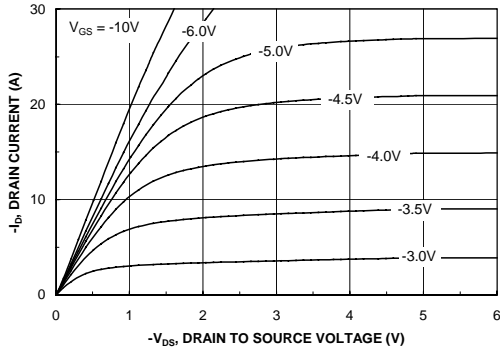

Figure 1. On-Region Characteristics.

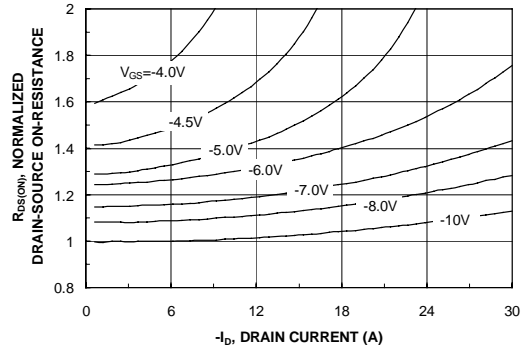

Figure 2. On-Resistance Variation with Drain Current and Gate Voltage.

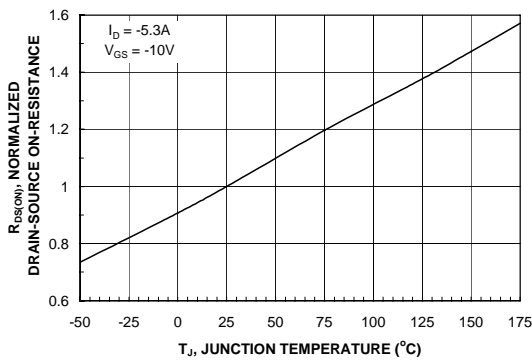

Figure 3. On-Resistance Variation with Temperature.

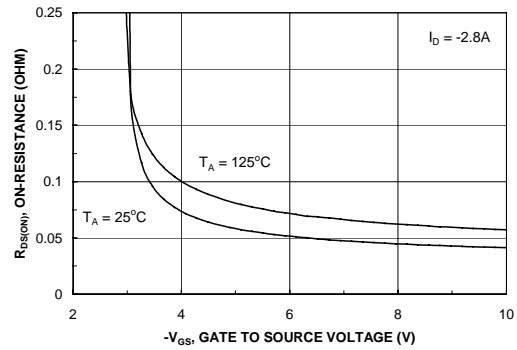

Figure 4. On-Resistance Variation with Gate-to-Source Voltage.

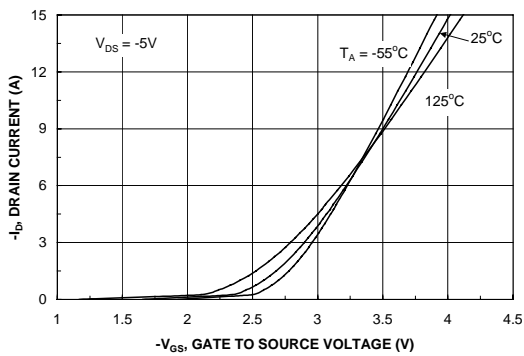

Figure 5. Transfer Characteristics.

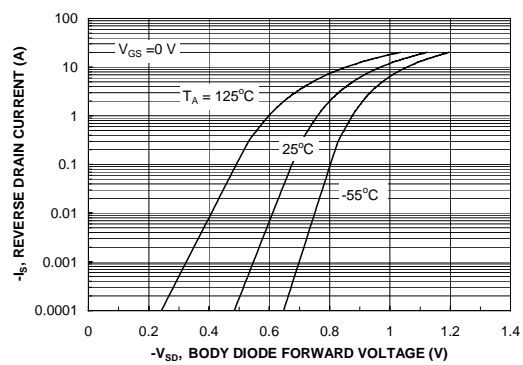

Figure 6. Body Diode Forward Voltage Variation with Source Current and Temperature.

Typical Characteristics

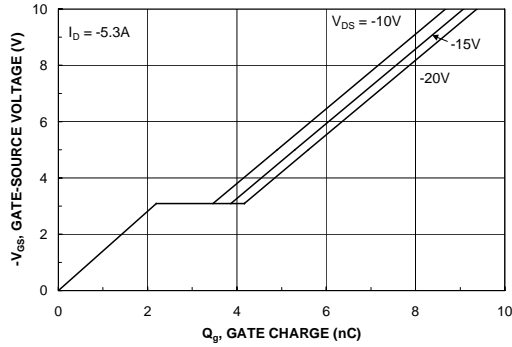

Figure 7. Gate Charge Characteristics.

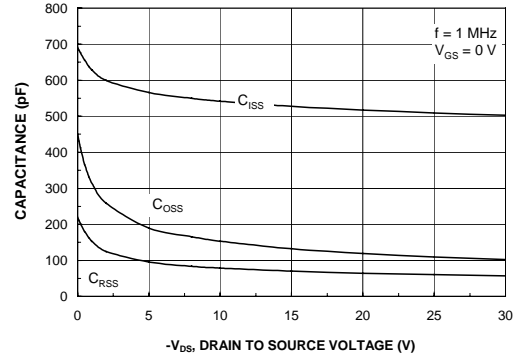

Figure 8. Capacitance Characteristics.

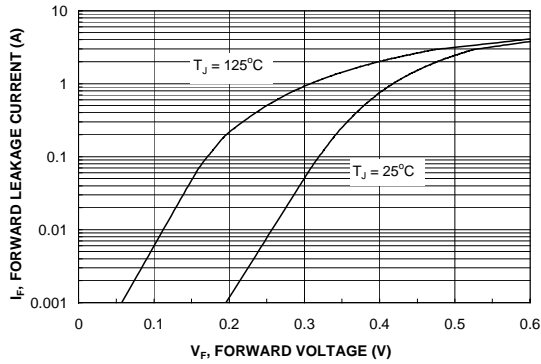

Figure 9. Schottky Diode Forward Voltage.

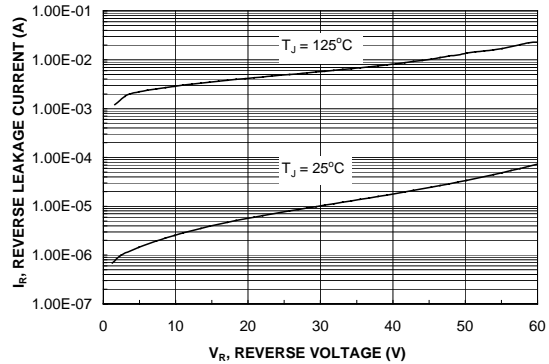

Figure 10. Schottky Diode Reverse Current.

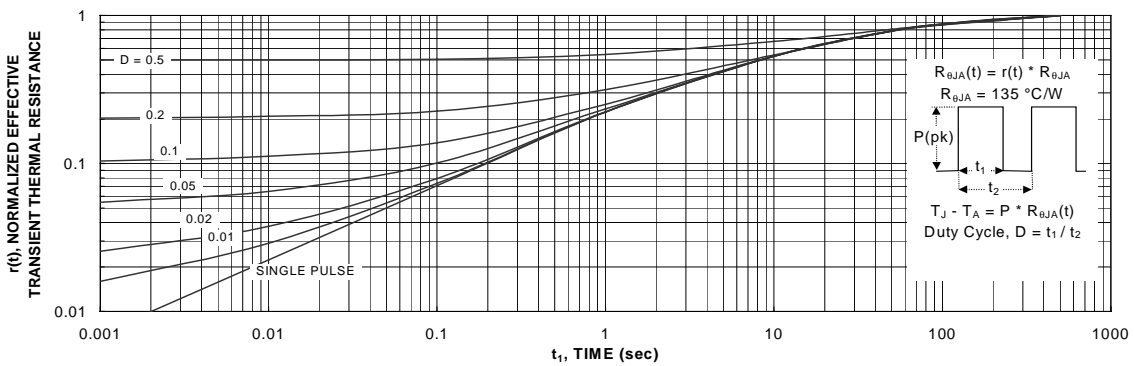

Figure 11. Transient Thermal Response Curve.

Thermal characterization performed using the conditions described in Note 1c.
Transient thermal response will change depending on the circuit board design.

SOIC-8 Tape and Reel Data



SOIC(8lds) Packaging Configuration: Figure 1.0

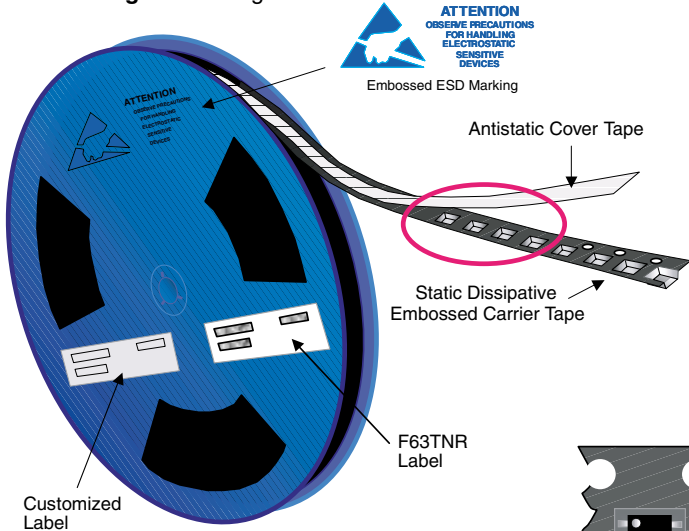

Packaging Description:

SOIC-8 parts are shipped in tape. The carrier tape is made from a dissipative (carbon filled) polycarbonate resin. The cover tape is a multilayer film (Heat Activated Adhesive in nature) primarily composed of polyester film, adhesive layer, sealant, and anti-static sprayed agent. These reeled parts in standard option are shipped with 2,500 units per 13" or 330cm diameter reel. The reels are dark blue in color and is made of polystyrene plastic (anti-static coated). Other option comes in 500 units per 7" or 177cm diameter reel. This and some other options are further described in the Packaging Information table.

These full reels are individually barcode labeled and placed inside a standard intermediate box (illustrated in figure 1.0) made of recyclable corrugated brown paper. One box contains two reels maximum. And these boxes are placed inside a barcode labeled shipping box which comes in different sizes depending on the number of parts shipped.

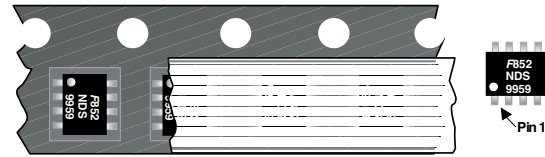

SOIC-8 Unit Orientation

| SOIC(8lds) Packaging Information | | | | |
|----------------------------------|-------------------------|------------|------------|------------|
| Packaging Option | Standard (no flow code) | L86Z | F011 | D84Z |
| Packaging type | TNR | Rail/Tube | TNR | TNR |
| Qty per Reel/Tube/Bag | 2,500 | 95 | 4,000 | 500 |
| Reel Size | 13" Dia | - | 13" Dia | 7" Dia |
| Box Dimension (mm) | 355x333x40 | 530x130x83 | 355x333x40 | 193x183x80 |
| Max qty per Box | 5,000 | 30,000 | 8,000 | 2,000 |
| Weight per unit(gm) | 0.0774 | 0.0774 | 0.0774 | 0.0774 |
| Weight per Reel (kg) | 0.6060 | - | 0.9696 | 0.1182 |
| Note/Comments | | | | |

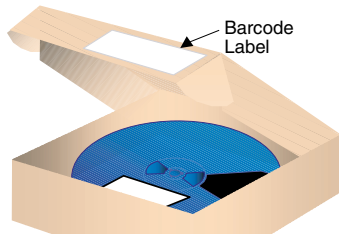
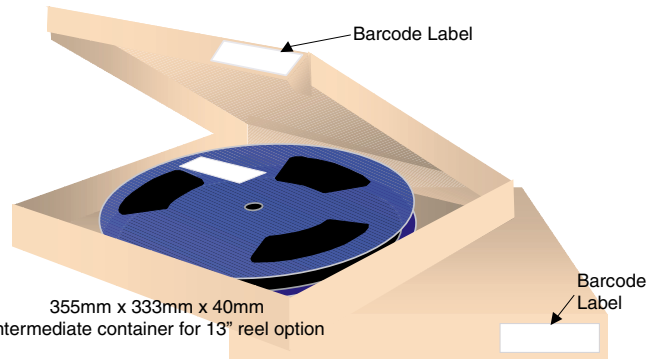

Barcode Label sample



SOIC(8lds) Tape Leader and Trailer Configuration: Figure 2.0

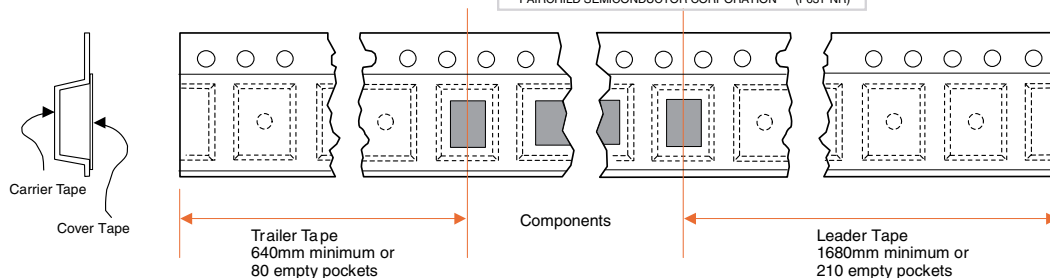

SOIC-8 Tape and Reel Data, continued

SOIC(8lds) Embossed Carrier Tape Configuration: Figure 3.0

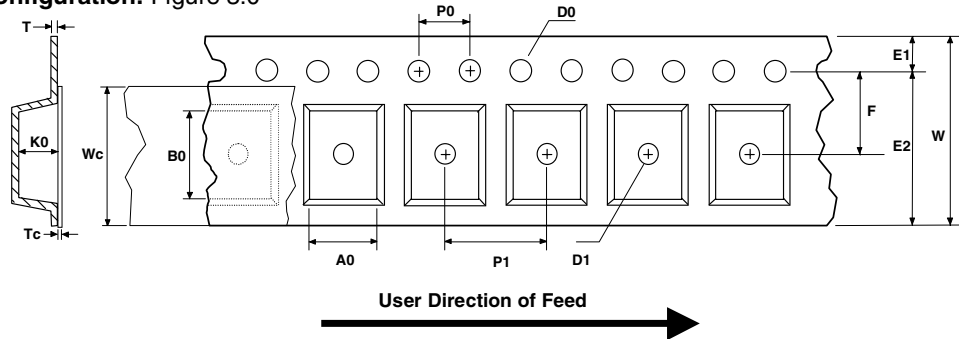

| Dimensions are in millimeter | | | | | | | | | | | | | | |
|------------------------------|-----------------|-----------------|----------------|-----------------|-----------------|-----------------|--------------|-----------------|---------------|---------------|----------------|-----------------------|---------------|-----------------|
| Pkg type | A0 | B0 | W | D0 | D1 | E1 | E2 | F | P1 | P0 | K0 | T | Wc | Tc |
| SOIC(8lds) (12mm) | 5.30 +/-0.10 | 6.50 +/-0.10 | 12.0 +/-0.3 | 1.55 +/-0.05 | 1.60 +/-0.10 | 1.75 +/-0.10 | 10.25 min | 5.50 +/-0.05 | 8.0 +/-0.1 | 4.0 +/-0.1 | 2.1 +/-0.10 | 0.450 +/- 0.150 | 9.2 +/-0.3 | 0.06 +/-0.02 |

Notes: A0, B0, and K0 dimensions are determined with respect to the EIA/Jedec RS-481 rotational and lateral movement requirements (see sketches A, B, and C).

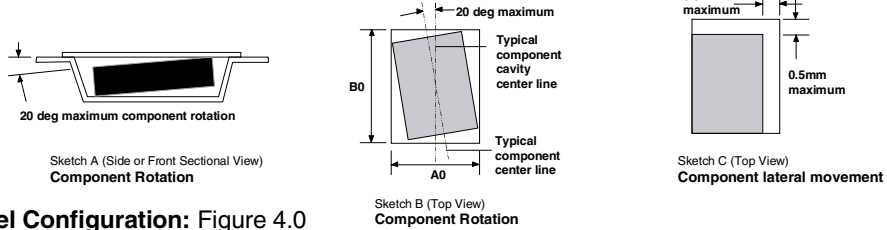

SOIC(8lds) Reel Configuration: Figure 4.0

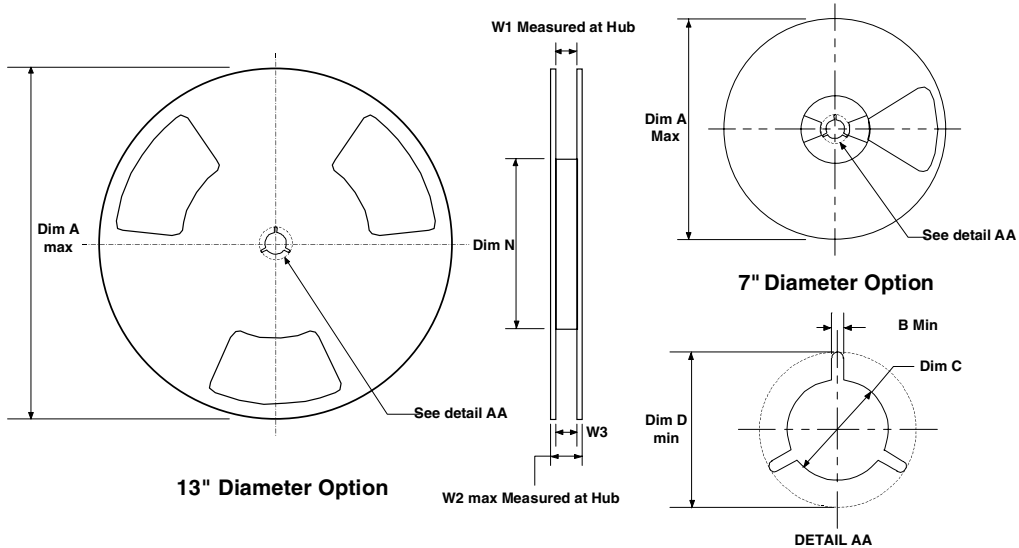

| Dimensions are in inches and millimeters | | | | | | | | | |
|--|-------------|---------------|--------------|-----------------------------------|---------------|-------------|----------------------------------|---------------|------------------------------|
| Tape Size | Reel Option | Dim A | Dim B | Dim C | Dim D | Dim N | Dim W1 | Dim W2 | Dim W3 (LSL-USL) |
| 12mm | 7" Dia | 7.00 177.8 | 0.059 1.5 | 512 +0.020/-0.008 13 +0.5/-0.2 | 0.795 20.2 | 2.165 55 | 0.488 +0.078/-0.000 12.4 +2/0 | 0.724 18.4 | 0.469 - 0.606 11.9 - 15.4 |
| 12mm | 13" Dia | 13.00 330 | 0.059 1.5 | 512 +0.020/-0.008 13 +0.5/-0.2 | 0.795 20.2 | 7.00 178 | 0.488 +0.078/-0.000 12.4 +2/0 | 0.724 18.4 | 0.469 - 0.606 11.9 - 15.4 |

SOIC-8 Package Dimensions



SOIC-8 (FS PKG Code S1)

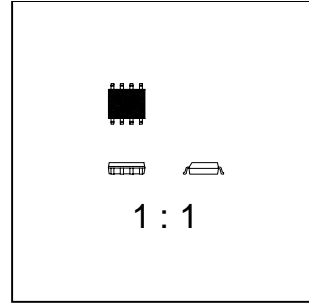
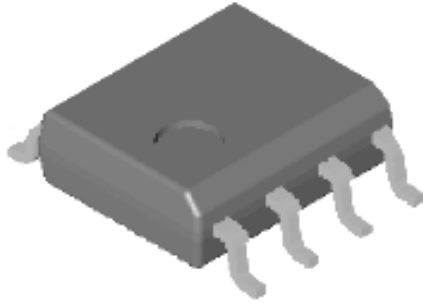

Scale 1:1 on letter size paper

Dimensions shown below are in:
inches [millimeters]

Part Weight per unit (gram): 0.0774

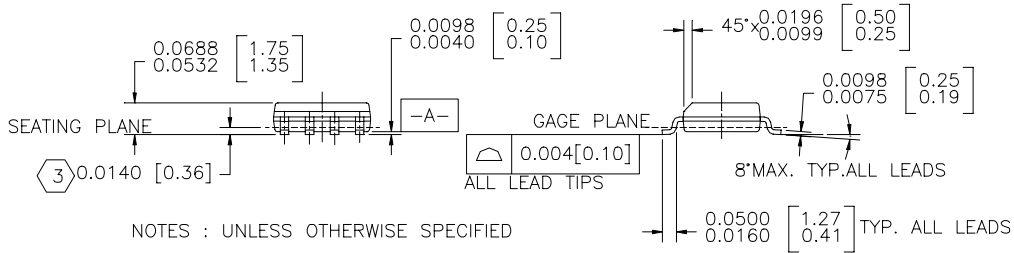
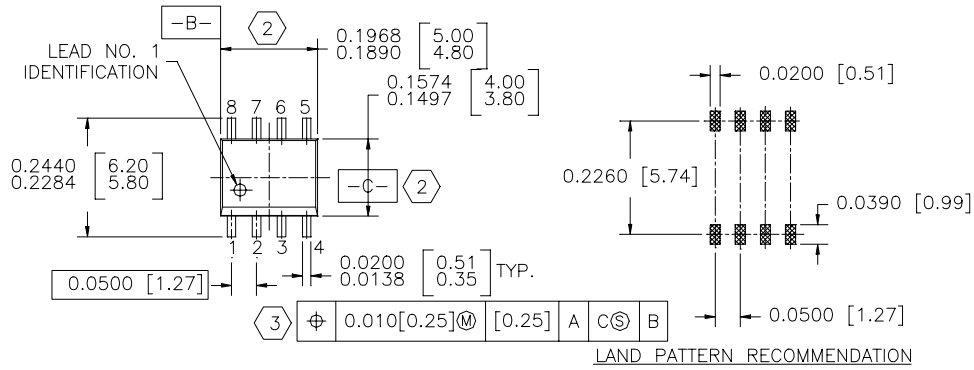

NOTES : UNLESS OTHERWISE SPECIFIED

- STANDARD LEAD FINISH:
200 MICROINCHES / 5.08 MICRONS MINIMUM
LEAD / TIN (SOLDER) ON COPPER.

SO 0.150 WIDE 8 LEADS

- THESE DIMENSIONS DO NOT INCLUDE MOLD FLASH
- MAXIMUM LEAD 0.024 [0.609]

TRADEMARKS

The following are registered and unregistered trademarks Fairchild Semiconductor owns or is authorized to use and is not intended to be an exhaustive list of all such trademarks.

| | | | | |
|-----------------------------------|----------------------------------|----------------------------------|------------------------------|-------------------|
| ACE _x TM | FAST [®] | OPTOLOGIC TM | SMART START TM | VCX TM |
| Bottomless TM | FAST _r TM | OPTOPLANAR TM | STAR*POWER TM | |
| CoolFET TM | FRFET TM | PACMAN TM | Stealth TM | |
| CROSSVOLT TM | GlobalOptoisolator TM | POP TM | SuperSOT TM -3 | |
| DenseTrench TM | GTO TM | Power247 TM | SuperSOT TM -6 | |
| DOMET TM | HiSeC TM | PowerTrench [®] | SuperSOT TM -8 | |
| EcoSPARK TM | ISOPLANAR TM | QFET TM | SyncFET TM | |
| E ² CMOS TM | LittleFET TM | QST TM | TinyLogic TM | |
| EnSigna TM | MicroFET TM | QT Optoelectronics TM | TruTranslation TM | |
| FACT TM | MicroPak TM | Quiet Series TM | UHC TM | |
| FACT Quiet Series TM | MICROWIRE TM | SILENT SWITCHER [®] | UltraFET [®] | |

STAR*POWER is used under license

DISCLAIMER

FAIRCHILD SEMICONDUCTOR RESERVES THE RIGHT TO MAKE CHANGES WITHOUT FURTHER NOTICE TO ANY PRODUCTS HEREIN TO IMPROVE RELIABILITY, FUNCTION OR DESIGN. FAIRCHILD DOES NOT ASSUME ANY LIABILITY ARISING OUT OF THE APPLICATION OR USE OF ANY PRODUCT OR CIRCUIT DESCRIBED HEREIN; NEITHER DOES IT CONVEY ANY LICENSE UNDER ITS PATENT RIGHTS, NOR THE RIGHTS OF OTHERS.

LIFE SUPPORT POLICY

FAIRCHILD'S PRODUCTS ARE NOT AUTHORIZED FOR USE AS CRITICAL COMPONENTS IN LIFE SUPPORT DEVICES OR SYSTEMS WITHOUT THE EXPRESS WRITTEN APPROVAL OF FAIRCHILD SEMICONDUCTOR CORPORATION.

As used herein:

1. Life support devices or systems are devices or systems which, (a) are intended for surgical implant into the body, or (b) support or sustain life, or (c) whose failure to perform when properly used in accordance with instructions for use provided in the labeling, can be reasonably expected to result in significant injury to the user.
2. A critical component is any component of a life support device or system whose failure to perform can be reasonably expected to cause the failure of the life support device or system, or to affect its safety or effectiveness.

PRODUCT STATUS DEFINITIONS

Definition of Terms

| Datasheet Identification | Product Status | Definition |
|--------------------------|------------------------|---|
| Advance Information | Formative or In Design | This datasheet contains the design specifications for product development. Specifications may change in any manner without notice. |
| Preliminary | First Production | This datasheet contains preliminary data, and supplementary data will be published at a later date. Fairchild Semiconductor reserves the right to make changes at any time without notice in order to improve design. |
| No Identification Needed | Full Production | This datasheet contains final specifications. Fairchild Semiconductor reserves the right to make changes at any time without notice in order to improve design. |
| Obsolete | Not In Production | This datasheet contains specifications on a product that has been discontinued by Fairchild semiconductor. The datasheet is printed for reference information only. |