



FCH077N65F_F085

N-Channel SuperFET II FRFET MOSFET

650 V, 54 A, 77 mΩ



Features

- Typical $R_{DS(on)}$ = 68 mΩ at $V_{GS} = 10\text{ V}$, $I_D = 27\text{ A}$
- Typical $Q_{g(tot)}$ = 126 nC at $V_{GS} = 10\text{ V}$, $I_D = 27\text{ A}$
- UIS Capability
- Qualified to AEC Q101
- RoHS Compliant

Description

SuperFET® II MOSFET is Fairchild Semiconductor's brand-new high voltage super-junction (SJ) MOSFET family that is utilizing charge balance technology for outstanding low on-resistance and lower gate charge performance. This technology is tailored to minimize conduction loss, provide superior switching performance, dv/dt rate and higher avalanche energy. Consequently SuperFETII is very well suited for the Soft switching and Hard Switching topologies like High Voltage Full Bridge and Half Bridge DC-DC, Interleaved Boost PFC, Boost PFC for HEV-EV automotive.

SuperFET II FRFET® MOSFET's optimized body diode reverse recovery performance can remove additional component and improve system reliability.

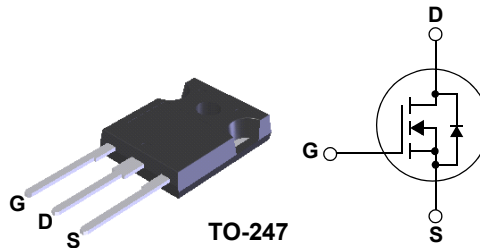

For current package drawing, please refer to the Fairchild website at <https://www.fairchildsemi.com/package-drawings/TO/TO247A03.pdf>

Application

- Automotive On Board Charger
- Automotive DC/DC converter for HEV



Maximum Ratings $T_C = 25^\circ\text{C}$ unless otherwise noted

Symbol	Parameter	Ratings	Units
V_{DSS}	Drain to Source Voltage	650	V
V_{GS}	Gate to Source Voltage	± 20	V
I_D	Drain Current - Continuous ($V_{GS}=10$) (Note 1)	54	A
	Pulsed Drain Current	See Fig 4	A
E_{AS}	Single Pulse Avalanche Rating (Note 2)	1128	mJ
dv/dt	MOSFET dv/dt	100	V/ns
	Peak Diode Recovery dv/dt (Note 3)	50	
P_D	Power Dissipation	481	W
	Derate Above 25°C	3.85	W/ $^\circ\text{C}$
T_J, T_{STG}	Operating and Storage Temperature	-55 to + 150	$^\circ\text{C}$
$R_{\theta JC}$	Maximum Thermal Resistance Junction to Case	0.26	$^\circ\text{C/W}$
$R_{\theta JA}$	Maximum Thermal Resistance Junction to Ambient (Note 4)	40	$^\circ\text{C/W}$

Package Marking and Ordering Information

Device Marking	Device	Package	Reel Size	Tape Width	Quantity
FCH077N65F	FCH077N65F_F085	TO-247	-	-	30

Notes:

- 1: Current is limited by bondwire configuration.
- 2: Starting $T_J = 25^\circ\text{C}$, $L = 18.65\text{mH}$, $I_{AS} = 11\text{A}$, $V_{DD} = 100\text{V}$ during inductor charging and $V_{DD} = 0\text{V}$ during time in avalanche.
- 3: $I_{SD} \leq 27\text{A}$, $di/dt \leq 200\text{ A/us}$, $V_{DD} \leq 380\text{V}$, starting $T_J = 25^\circ\text{C}$.
- 4: $R_{\theta JA}$ is the sum of the junction-to-case and case-to-ambient thermal resistance, where the case thermal reference is defined as the solder mounting surface of the drain pins. $R_{\theta JC}$ is guaranteed by design, while $R_{\theta JA}$ is determined by the board design. The maximum rating presented here is based on mounting on a 1 in² pad of 2oz copper.

FCH077N65F_F085 N-Channel SuperFET II FRFET MOSFET

Electrical Characteristics $T_J = 25^\circ\text{C}$ unless otherwise noted

Symbol	Parameter	Test Conditions	Min	Typ	Max	Units
--------	-----------	-----------------	-----	-----	-----	-------

Off Characteristics

B_{VDSS}	Drain to Source Breakdown Voltage	$I_D = 250\mu\text{A}, V_{GS} = 0\text{V}$	650	-	-	V
I_{DSS}	Drain to Source Leakage Current	$V_{DS} = 650\text{V}, T_J = 25^\circ\text{C}$	-	-	10	μA
		$V_{GS} = 0\text{V}, T_J = 150^\circ\text{C}(\text{Note } 5)$	-	-	1	mA
I_{GSS}	Gate to Source Leakage Current	$V_{GS} = \pm 20\text{V}$	-	-	± 100	nA

On Characteristics

$V_{GS(th)}$	Gate to Source Threshold Voltage	$V_{GS} = V_{DS}, I_D = 250\mu\text{A}$	3.0	-	5.0	V
$r_{DS(on)}$	Drain to Source On Resistance	$I_D = 27\text{A}, T_J = 25^\circ\text{C}$	-	68	77	$\text{m}\Omega$
		$V_{GS} = 10\text{V}, T_J = 150^\circ\text{C}(\text{Note } 5)$	-	154	184	$\text{m}\Omega$

Dynamic Characteristics

C_{iss}	Input Capacitance	$V_{DS} = 25\text{V}, V_{GS} = 0\text{V}, f = 1\text{MHz}$	-	5385	7162	pF
C_{oss}	Output Capacitance		-	5629	7486	pF
C_{rss}	Reverse Transfer Capacitance		-	194	-	pF
$C_{oss(eff)}$	Effective Output Capacitance	$V_{DS} = 0\text{V to } 520\text{V}, V_{GS} = 0\text{V}$	-	693	-	pF
R_g	Gate Resistance	$f = 1\text{MHz}$	-	0.5	-	Ω
$Q_{g(ToT)}$	Total Gate Charge	$V_{DD} = 380\text{V}, I_D = 27\text{A}, V_{GS} = 10\text{V}$	-	126	164	nC
$Q_{g(th)}$	Threshold Gate Charge		-	9	12	nC
Q_{gs}	Gate to Source Gate Charge		-	28	-	nC
Q_{gd}	Gate to Drain "Miller" Charge		-	53	-	nC

Switching Characteristics

t_{on}	Turn-On Time	$V_{DD} = 380\text{V}, I_D = 27\text{A}, V_{GS} = 10\text{V}, R_G = 4.7\Omega$	-	64	148	ns
$t_{d(on)}$	Turn-On Delay Time		-	37	-	ns
t_r	Rise Time		-	27	-	ns
$t_{d(off)}$	Turn-Off Delay Time		-	105	-	ns
t_f	Fall Time		-	5.3	-	ns
t_{off}	Turn-Off Time		-	108.3	237	ns

Drain-Source Diode Characteristics

V_{SD}	Source to Drain Diode Voltage	$I_{SD} = 27\text{A}, V_{GS} = 0\text{V}$	-	-	1.2	V
T_{rr}	Reverse Recovery Time	$I_F = 27\text{A}, di_{SD}/dt = 100\text{A}/\mu\text{s}$	-	190	-	ns
Q_{rr}	Reverse Recovery Charge	$V_{DD} = 520\text{V}$	-	1.5	-	μC

Notes:

5: The maximum value is specified by design at $T_J = 150^\circ\text{C}$. Product is not tested to this condition in production.

Typical Characteristics

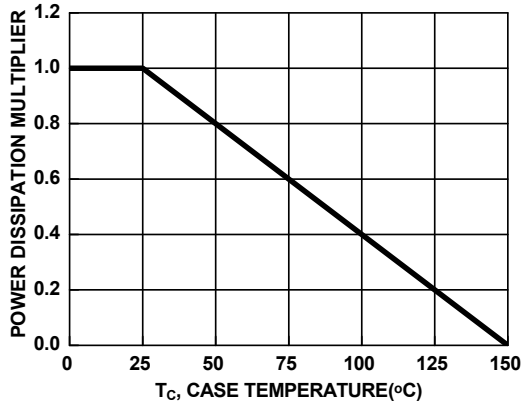

Figure 1. Normalized Power Dissipation vs. Case Temperature

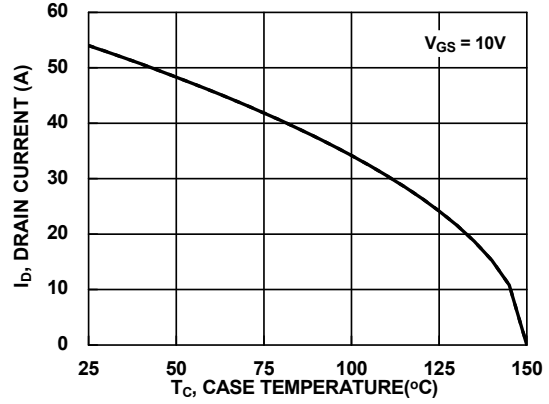

Figure 2. Maximum Continuous Drain Current vs. Case Temperature

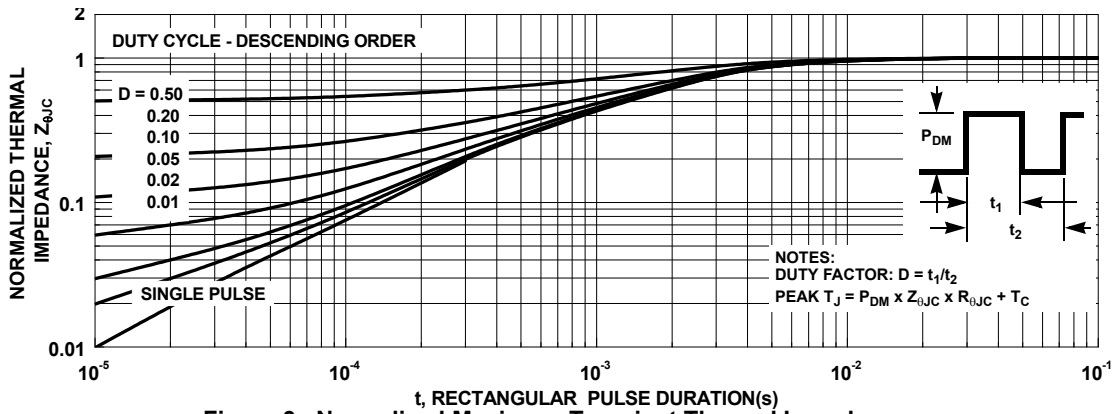

Figure 3. Normalized Maximum Transient Thermal Impedance

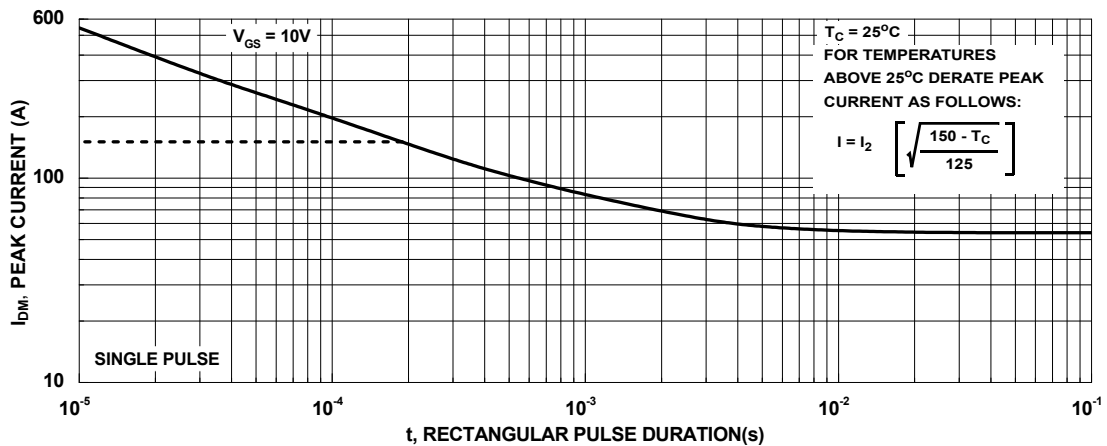

Figure 4. Peak Current Capability

Typical Characteristics

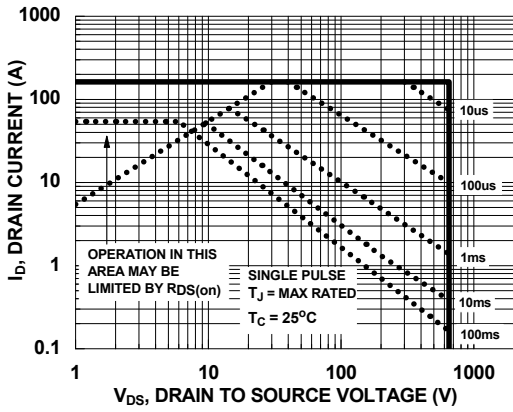

Figure 5. Forward Bias Safe Operating Area

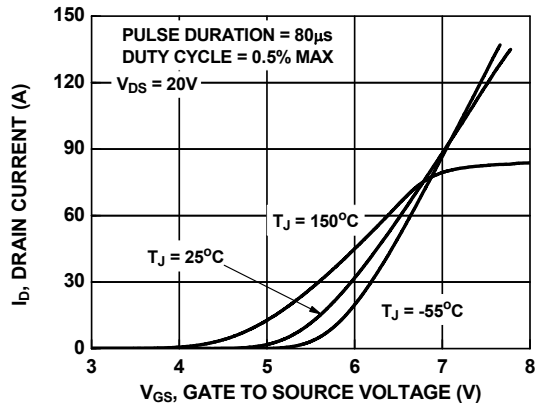

Figure 6. Transfer Characteristics

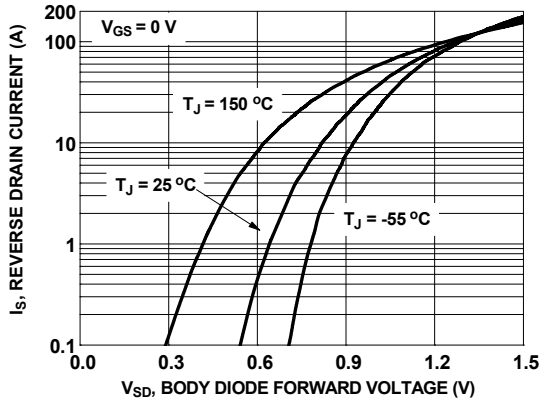

Figure 7. Forward Diode Characteristics

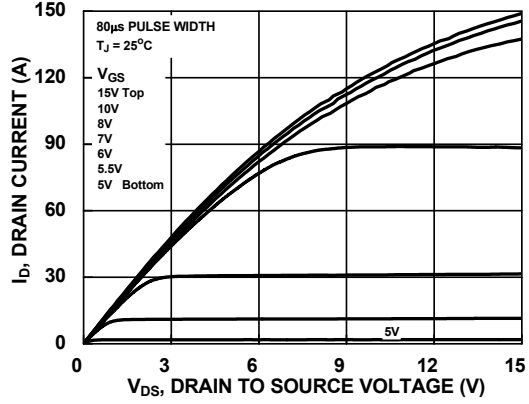

Figure 8. Saturation Characteristics

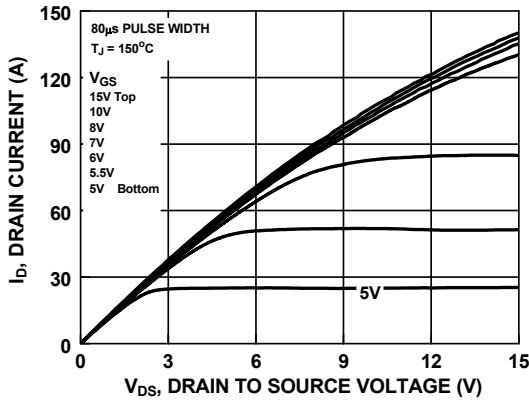

Figure 9. Saturation Characteristics

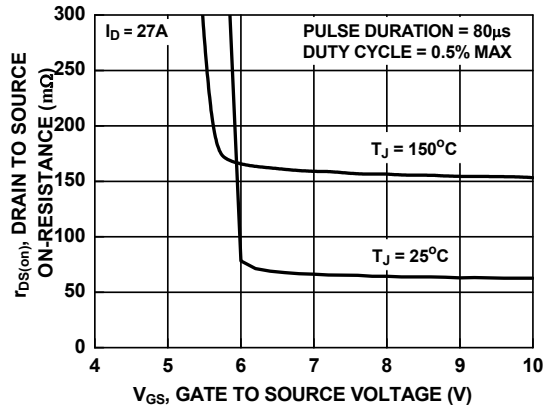

Figure 10. $R_{DS(on)}$ vs. Gate Voltage

Typical Characteristics

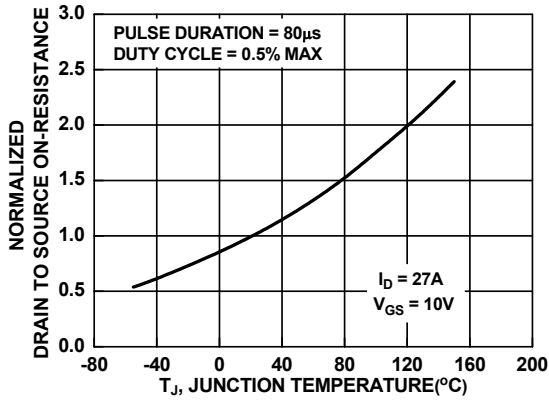

Figure 11. Normalized R_{DSON} vs. Junction Temperature

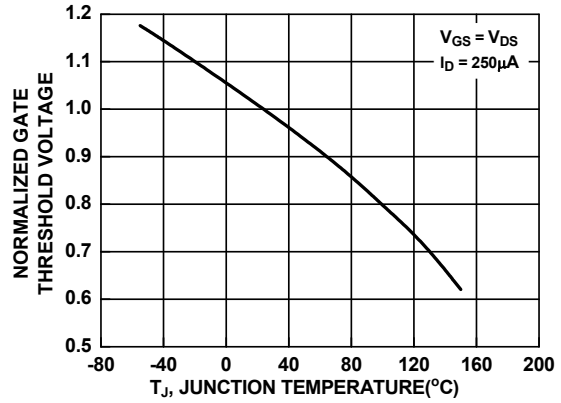

Figure 12. Normalized Gate Threshold Voltage vs. Temperature

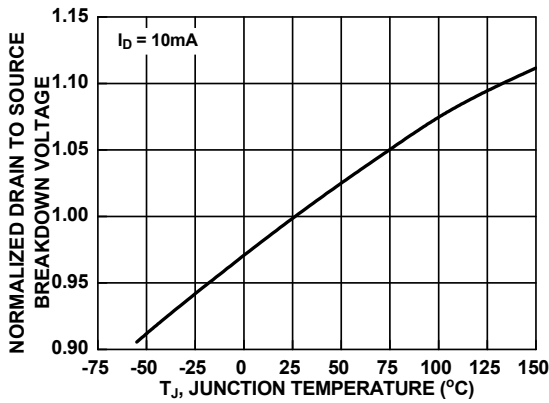

Figure 13. Normalized Drain to Source Breakdown Voltage vs. Junction Temperature

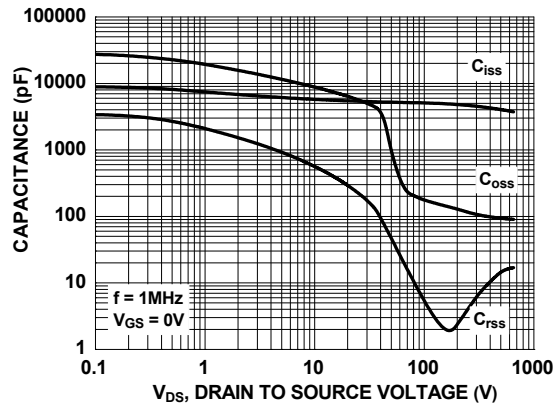

Figure 14. Capacitance vs. Drain to Source Voltage

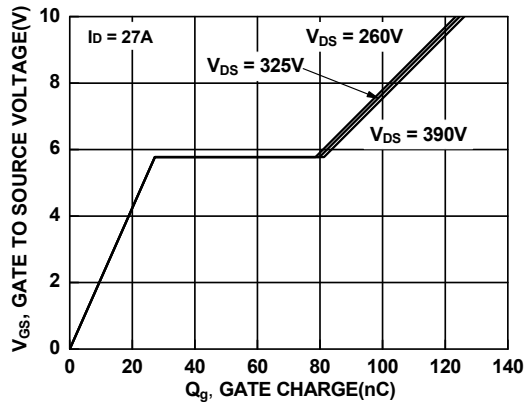

Figure 15. Gate Charge vs. Gate to Source Voltage

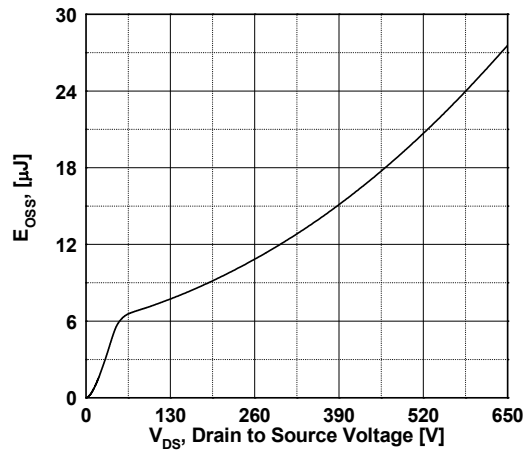

Figure 16. E_{oss} vs. Drain to Source Voltage

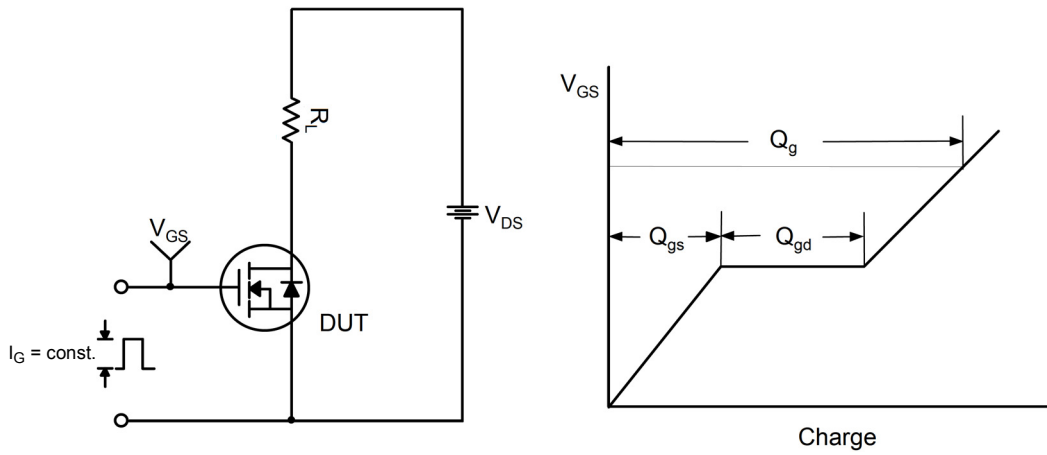

Figure 17. Gate Charge Test Circuit & Waveform

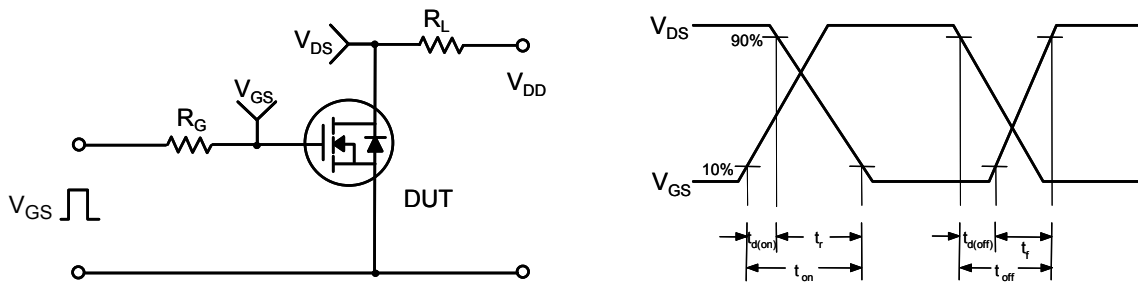

Figure 18. Resistive Switching Test Circuit & Waveforms

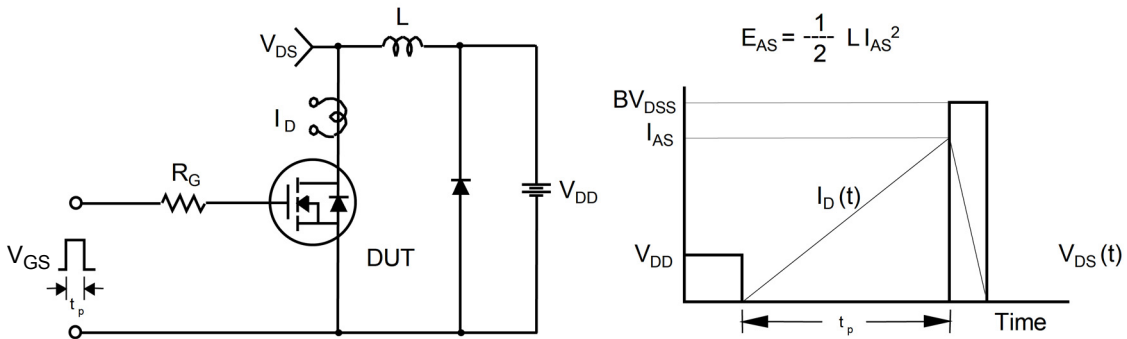
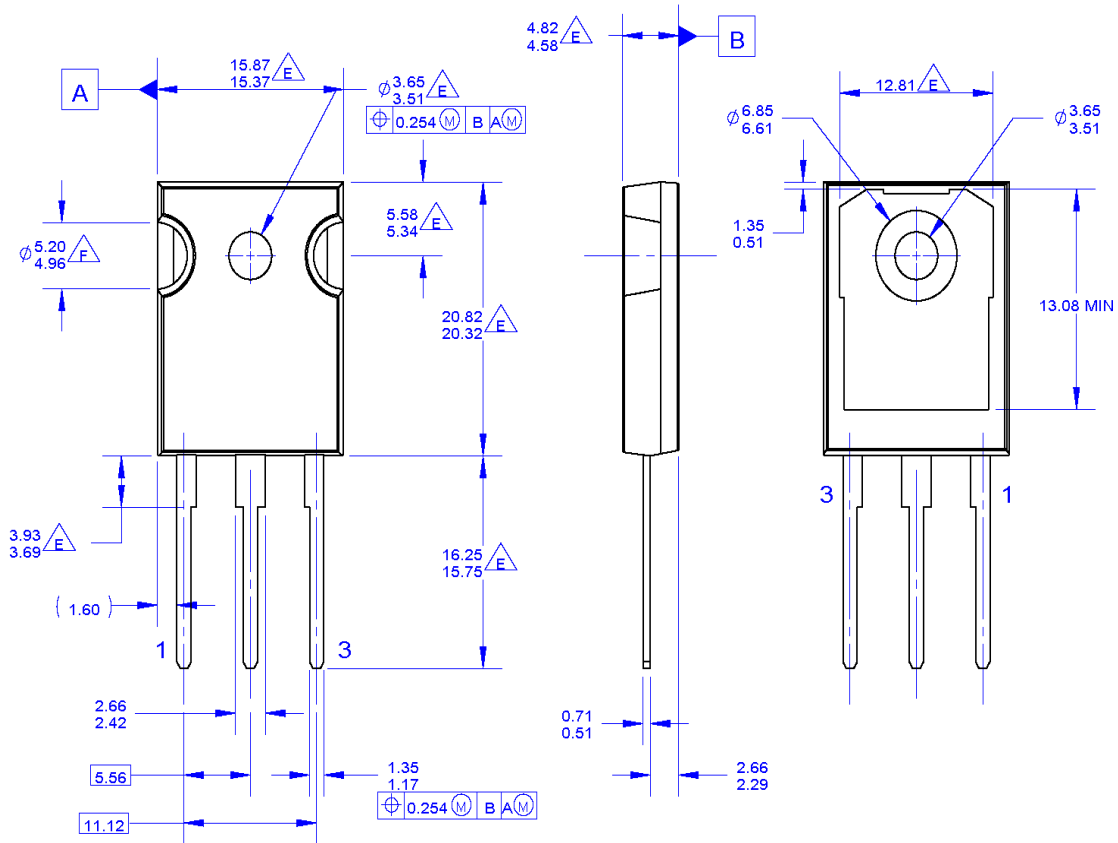

Figure 19. Unclamped Inductive Switching Test Circuit & Waveforms



Figure 20. Peak Diode Recovery dv/dt Test Circuit & Waveforms

Mechanical Dimensions



NOTES: UNLESS OTHERWISE SPECIFIED.

- A. PACKAGE REFERENCE: JEDEC TO-247, ISSUE E, VARIATION AB, DATED JUNE, 2004.
- B. DIMENSIONS ARE EXCLUSIVE OF BURRS, MOLD FLASH, AND TIE BAR EXTRUSIONS.
- C. ALL DIMENSIONS ARE IN MILLIMETERS.
- D. DRAWING CONFORMS TO ASME Y14.5 - 1994
- DOES NOT COMPLY JEDEC STANDARD VALUE
- NOTCH MAY BE SQUARE
- G. DRAWING FILENAME: MKT-TO247A03_REV03

Figure 21. TO-247, Molded, 3-Lead, Jedec Variation AB

Package drawings are provided as a service to customers considering Fairchild components. Drawings may change in any manner without notice. Please note the revision and/or date on the drawing and contact a Fairchild Semiconductor representative to verify or obtain the most recent revision. Package specifications do not expand the terms of Fairchild's worldwide terms and conditions, specifically the warranty therein, which covers Fairchild products.





Always visit Fairchild Semiconductor's online packaging area for the most recent package drawings:

<http://www.fairchildsemi.com/package-drawings/TO/TO247A03.pdf>



TRADEMARKS

The following includes registered and unregistered trademarks and service marks, owned by Fairchild Semiconductor and/or its global subsidiaries, and is not intended to be an exhaustive list of all such trademarks.

- | | | | |
|---|---|---|---|
| AccuPower™ | F-PFS™ | OPTOPLANAR® |  |
| Awinda® | FRFET® |  | TinyBoost® |
| AX-CAP®* | Global Power ResourceSM | PowerTrench® | TinyBuck™ |
| BitSiC™ | GreenBridge™ | PowerXS™ | TinyCalc™ |
| Build it Now™ | Green FPS™ | Programmable Active Droop™ | TinyLogic® |
| CorePLUS™ | Green FPS™ e-Series™ | QFET® | TINYOPTO™ |
| CorePOWER™ | Gmax™ | QS™ | TinyPower™ |
| CROSSVOLT™ | GTO™ | Quiet Series™ | TinyPWM™ |
| CTL™ | IntelliMAX™ | RapidConfigure™ | TinyWire™ |
| Current Transfer Logic™ | ISOPLANAR™ |  | TranSiC™ |
| DEUXPEED® | Marking Small Speakers Sound Louder and Better™ | Saving our world, 1mW/W/kW at a time™ | TriFault Detect™ |
| Dual Cool™ | MegaBuck™ | SignalWise™ | TRUECURRENT®* |
| EcoSPARK® | MICROCOUPLER™ | SmartMax™ | μSerDes™ |
| EfficientMax™ | MicroFET™ | SMART START™ |  |
| ESBC™ | MicroPak™ | Solutions for Your Success™ | UHC® |
|  | MicroPak2™ | SPM® | Ultra FRFET™ |
| Fairchild® | MillerDrive™ | STEALTH™ | UniFET™ |
| Fairchild Semiconductor® | MotionMax™ | SuperFET® | VCX™ |
| FACT Quiet Series™ | MotionGrid® | SuperSOT™-3 | VisualMax™ |
| FACT® | MTi® | SuperSOT™-6 | VoltagePlus™ |
| FAST® | MTx® | SuperSOT™-8 | XS™ |
| FastvCore™ | MVN® | SupreMOS® | Xsens™ |
| FETBench™ | mWSaver® | SyncFET™ | 仙童™ |
| FPS™ | OptoHiT™ | Sync-Lock™ | |
| | OPTOLOGIC® | | |

*Trademarks of System General Corporation, used under license by Fairchild Semiconductor.

DISCLAIMER

FAIRCHILD SEMICONDUCTOR RESERVES THE RIGHT TO MAKE CHANGES WITHOUT FURTHER NOTICE TO ANY PRODUCTS HEREIN TO IMPROVE RELIABILITY, FUNCTION, OR DESIGN. TO OBTAIN THE LATEST, MOST UP-TO-DATE DATASHEET AND PRODUCT INFORMATION, VISIT OUR WEBSITE AT [HTTP://WWW.FAIRCHILDSEMI.COM](http://www.fairchildsemi.com). FAIRCHILD DOES NOT ASSUME ANY LIABILITY ARISING OUT OF THE APPLICATION OR USE OF ANY PRODUCT OR CIRCUIT DESCRIBED HEREIN; NEITHER DOES IT CONVEY ANY LICENSE UNDER ITS PATENT RIGHTS, NOR THE RIGHTS OF OTHERS. THESE SPECIFICATIONS DO NOT EXPAND THE TERMS OF FAIRCHILD'S WORLDWIDE TERMS AND CONDITIONS, SPECIFICALLY THE WARRANTY THEREIN, WHICH COVERS THESE PRODUCTS.

LIFE SUPPORT POLICY

FAIRCHILD'S PRODUCTS ARE NOT AUTHORIZED FOR USE AS CRITICAL COMPONENTS IN LIFE SUPPORT DEVICES OR SYSTEMS WITHOUT THE EXPRESS WRITTEN APPROVAL OF FAIRCHILD SEMICONDUCTOR CORPORATION.

As used here in:

- Life support devices or systems are devices or systems which, (a) are intended for surgical implant into the body or (b) support or sustain life, and (c) whose failure to perform when properly used in accordance with instructions for use provided in the labeling, can be reasonably expected to result in a significant injury of the user.
- A critical component in any component of a life support, device, or system whose failure to perform can be reasonably expected to cause the failure of the life support device or system, or to affect its safety or effectiveness.

ANTI-COUNTERFEITING POLICY

Fairchild Semiconductor Corporation's Anti-Counterfeiting Policy. Fairchild's Anti-Counterfeiting Policy is also stated on our external website, www.fairchildsemi.com, under Sales Support.

Counterfeiting of semiconductor parts is a growing problem in the industry. All manufactures of semiconductor products are experiencing counterfeiting of their parts. Customers who inadvertently purchase counterfeit parts experience many problems such as loss of brand reputation, substandard performance, failed application, and increased cost of production and manufacturing delays. Fairchild is taking strong measures to protect ourselves and our customers from the proliferation of counterfeit parts. Fairchild strongly encourages customers to purchase Fairchild parts either directly from Fairchild or from Authorized Fairchild Distributors who are listed by country on our web page cited above. Products customers buy either from Fairchild directly or from Authorized Fairchild Distributors are genuine parts, have full traceability, meet Fairchild's quality standards for handling and storage and provide access to Fairchild's full range of up-to-date technical and product information. Fairchild and our Authorized Distributors will stand behind all warranties and will appropriately address and warranty issues that may arise. Fairchild will not provide any warranty coverage or other assistance for parts bought from Unauthorized Sources. Fairchild is committed to combat this global problem and encourage our customers to do their part in stopping this practice by buying direct or from authorized distributors.

PRODUCT STATUS DEFINITIONS

Definition of Terms

Datasheet Identification	Product Status	Definition
Advance Information	Formative / In Design	Datasheet contains the design specifications for product development. Specifications may change in any manner without notice.
Preliminary	First Production	Datasheet contains preliminary data; supplementary data will be published at a later date. Fairchild Semiconductor reserves the right to make changes at any time without notice to improve design.
No Identification Needed	Full Production	Datasheet contains final specifications. Fairchild Semiconductor reserves the right to make changes at any time without notice to improve the design.
Obsolete	Not In Production	Datasheet contains specifications on a product that is discontinued by Fairchild Semiconductor. The datasheet is for reference information only.