

# Dual, Noninverting Power MOSFET Radiation Hardened Drivers

## HS-4424DRH, HS4424DEH

The radiation hardened HS-4424 family are noninverting, dual, monolithic high-speed MOSFET drivers designed to convert low voltage control input signals into higher voltage, high current outputs. The [HS-4424DRH](#), [HS-4424DEH](#) are fully tested across the 8V to 18V operating range.

The inputs of these devices can be directly driven by the HS-1825ARH PWM device or by our ACS/ACTS and HCS/HCTS type logic devices. The fast rise times and high current outputs allow very quick control of high gate capacitance power MOSFETs in high frequency applications.

The high current outputs minimize power losses in MOSFETs by rapidly charging and discharging the gate capacitance. The output stage incorporates a low voltage lockout circuit that puts the outputs into a three-state mode when the supply voltage is below its Undervoltage Lockout (UVLO) threshold voltage.

Constructed with Intersil's dielectrically isolated Rad Hard Silicon Gate (RSG) BiCMOS process, these devices are immune to single event latch-up and have been specifically designed to provide highly reliable performance in harsh radiation environments.

TABLE 1. HS4424 PRODUCT FAMILY SPECIFIC UVLO Vth

PART NUMBER	UVLO (V)
HS-4424RH HS-4424EH	<10
HS4424BRH HS4424BEH	<7.5
HS4424DRH HS4424DEH	<8

## Features

- Electrically screened to DLA SMD# [5962-99560](#)
- QML qualified per MIL-PRF-38535 requirements
- Latch-up immune
- Radiation environment
- High dose rate (50-300rad(Si)/s) . . . . . 300krad(Si)
- Low dose rate (0.01rad(Si)/s) . . . . . 50krad(Si)\*
- \*Limit established by characterization
- I<sub>PEAK</sub> . . . . . >2A (minimum)
- Matched rise and fall times (C<sub>L</sub> = 4300pF) . . 75ns (maximum)
- Low voltage lockout feature . . . . . <8V
- Wide supply voltage range . . . . . 8V to 18V
- Propagation delay . . . . . 250ns (maximum)
- Consistent delay times with V<sub>CC</sub> changes
- Low power consumption
  - 40mW with inputs high
  - 20mW with inputs low
- Low equivalent input capacitance . . . . . 3.2pF (typical)
- ESD protected . . . . . >4kV

## Applications

- Switching power supplies
- DC/DC converters
- Motor controllers

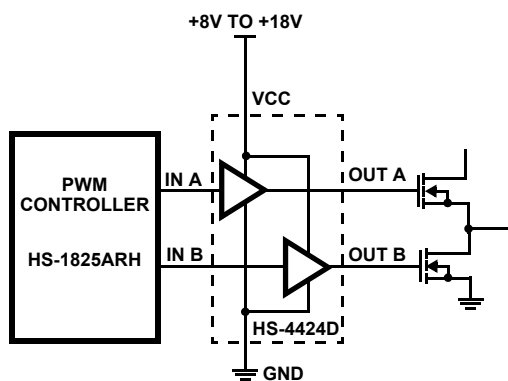

FIGURE 1. TYPICAL APPLICATION

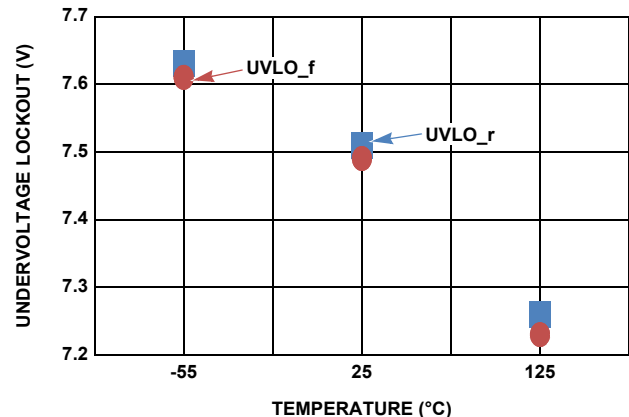
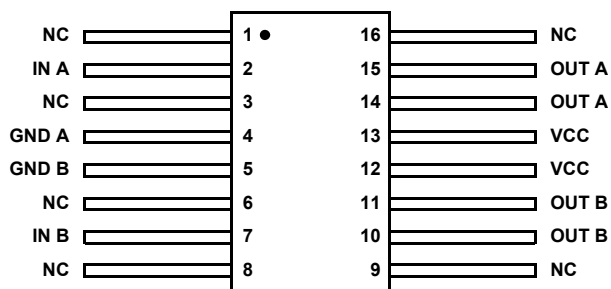

FIGURE 2. UNDERVOLTAGE LOCKOUT vs TEMPERATURE

# HS-4424DRH, HS4424DEH

## Pin Configuration

HS-4424DRH, HS-4424DEH  
(16 LD FLATPACK)  
TOP VIEW



## Pin Descriptions

PIN NUMBER	PIN NAME	EQUIVALENT ESD CIRCUIT	DESCRIPTION
1, 3, 6, 8, 9, 16	NC	NA	No Internal Connection
2	IN A	Circuit 2	Driver A Input
4	GND A	NA	Ground Reference A
5	GND B	NA	Ground Reference B
7	IN B	Circuit 2	Driver B Input
10, 11	OUT B	NA	Driver B Output
12, 13	VCC	Circuit 1	Positive Power Supply
14, 15	OUT A	NA	Driver A Output

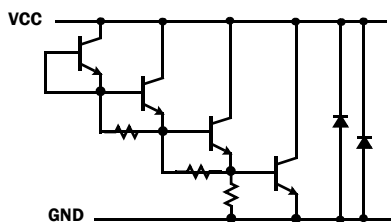

FIGURE 3. CIRCUIT 1

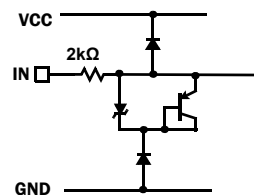

FIGURE 4. CIRCUIT 2

# HS-4424DRH, HS4424DEH

## Functional Block Diagram

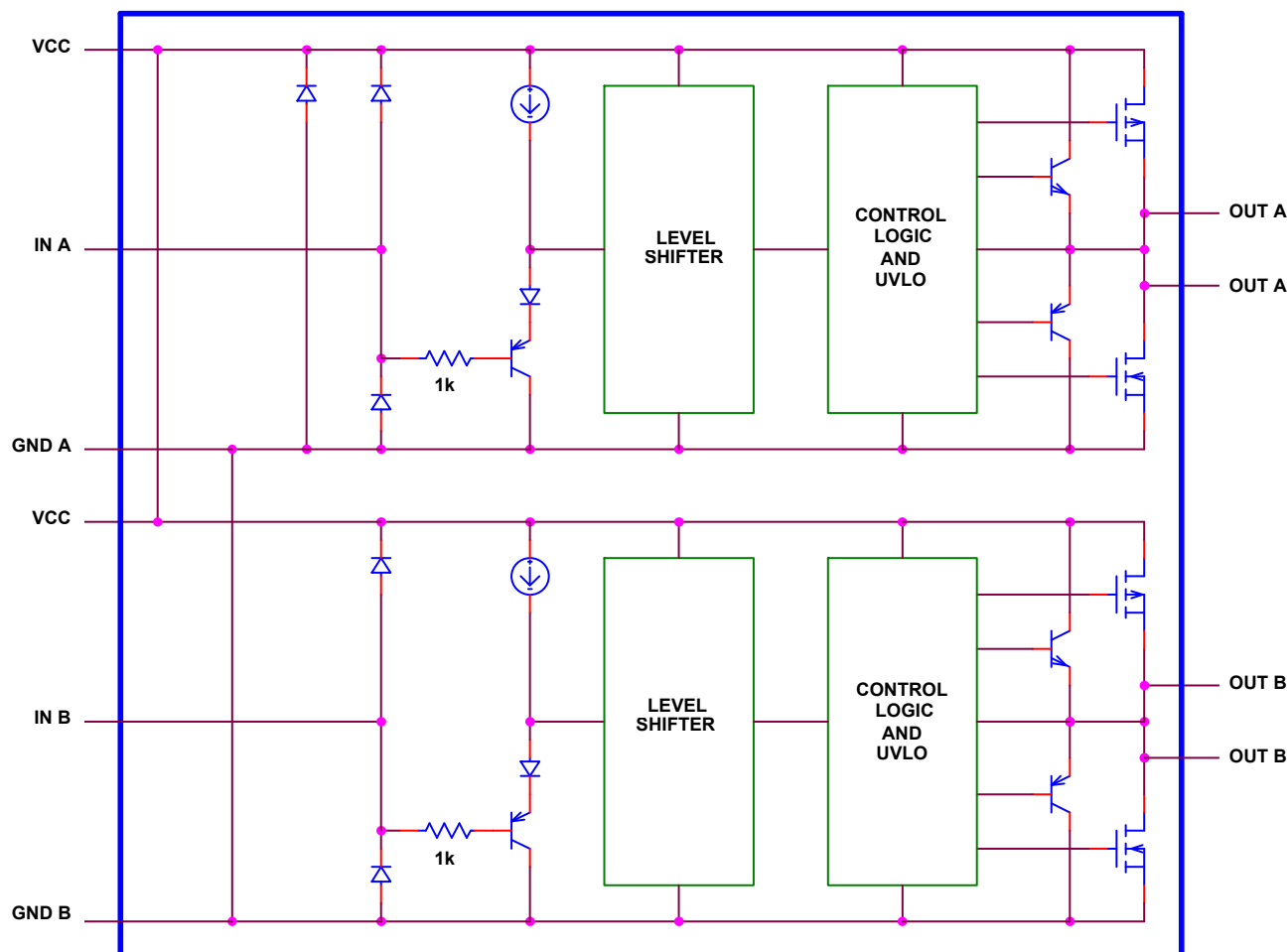

FIGURE 5. BLOCK DIAGRAM

## Ordering Information

SMD NUMBER ORDERING (Note 2)	PART NUMBER (Note 1)	TEMPERATURE RANGE (°C)	PACKAGE (RoHS Compliant)	PKG. DWG. #
5962F9956005V9A	HS0-4424DRH-Q	-55 to +125	DIE	
HS0-4424DRH/SAMPLE	HS0-4424DRH/SAMPLE	-55 to +125	DIE SAMPLE	
5962F9956005VXC	HS9-4424DRH-Q	-55 to +125	16 Ld Flatpack	K16.A
HS9-4424DRH/PROTO	HS9-4424DRH/PROTO	-55 to +125	16 Ld Flatpack	K16.A
5962F9956006V9A	HS0-4424DEH-Q	-55 to +125	DIE	
5962F9956006VXC	HS9-4424DEH-Q	-55 to +125	16 Ld Flatpack	K16.A

### NOTES:

1. These Intersil Pb-free Hermetic packaged products employ 100% Au plate - e4 termination finish, which is RoHS compliant and compatible with both SnPb and Pb-free soldering operations.
2. Specifications for Rad Hard QML devices are controlled by the Defense Logistics Agency Land and Maritime (DLA). The SMD numbers listed in the "Ordering Information" table must be used when ordering.

# HS-4424DRH, HS4424DEH

## Absolute Maximum Ratings

Maximum Supply Voltage	20V
Min/Max Input Voltage	-0.3V to $V_{CC}$
Output Short-circuit Duration (1 output at a time)	Indefinite
ESD Rating	
Human Body Model (Tested per MIL-PRF-883 3015.7)	5kV
Machine Model (Tested per MIL-PRF-883 3015.7)	200V
Charged Device Model (Tested per JESD22-C101D)	750V

## Thermal Information

Thermal Resistance (Typical)	$\theta_{JA}$ ( $^{\circ}\text{C}/\text{W}$ )	$\theta_{JC}$ ( $^{\circ}\text{C}/\text{W}$ )
16 Ld Flatpack Package (Notes 3, 4)	34	5
Storage Temperature Range	-65 $^{\circ}\text{C}$ to +150 $^{\circ}\text{C}$	
Maximum Operating Junction Temperature	+175 $^{\circ}\text{C}$	
Maximum Lead Temperature (Soldering 10 secs)	+265 $^{\circ}\text{C}$	

## Recommended Operating Conditions

Ambient Operating Temperature Range	-55 $^{\circ}\text{C}$ to +125 $^{\circ}\text{C}$
Maximum Operating Junction Temperature	+150 $^{\circ}\text{C}$
Supply Voltage	8V to 18V

CAUTION: Do not operate at or near the maximum ratings listed for extended periods of time. Exposure to such conditions may adversely impact product reliability and result in failures not covered by warranty.

### NOTES:

- $\theta_{JA}$  is measured in free air with the component mounted on a high effective thermal conductivity test board with "direct attach" features. See Tech Brief [TB379](#) for details.
- For  $\theta_{JC}$ , the "case temp" location is the center of the package underside.

**Electrical Specifications**  $V_{CC} = 8\text{V}, 12\text{V}, 18\text{V}, T_A = +25^{\circ}\text{C}$ , unless otherwise noted. **Boldface limits apply across the operating temperature range, -55 $^{\circ}\text{C}$  to +125 $^{\circ}\text{C}$ ; over radiation total ionizing dose.**

PARAMETER	DESCRIPTION	TEST CONDITIONS	MIN (Note 5)	TYP	MAX (Note 5)	UNIT
$V_{SUPPLY}$	Supply Voltage Range		<b>8</b>		<b>18</b>	V
$I_{CCSB\ LOW}$	18V Bias Current	$V_S = 18\text{V}, \text{Inputs} = 0\text{V}$			3.5	mA
		$V_S = 18\text{V}, \text{Inputs} = 0\text{V}$			<b>4</b>	mA
		$V_S = 18\text{V}, \text{Inputs} = 0\text{V}, \text{post radiation}$			<b>4</b>	mA
$I_{CCSB\ HIGH}$	18V Bias Current	$V_S, \text{Inputs} = 18\text{V}$			3.5	mA
		$V_S, \text{Inputs} = 18\text{V}$			<b>4</b>	mA
		$V_S, \text{Inputs} = 18\text{V}, \text{post radiation}$			<b>4</b>	mA
$I_{CCSB\ LOW}$	8V Bias Current	$V_S = 8\text{V}, \text{Inputs} = 0\text{V}$			3.5	mA
		$V_S = 8\text{V}, \text{Inputs} = 0\text{V}$			<b>4</b>	mA
		$V_S = 8\text{V}, \text{Inputs} = 0\text{V}, \text{post radiation}$			<b>4</b>	mA
$I_{CCSB\ HIGH}$	8V Bias Current	$V_S, \text{Inputs} = 8\text{V}$			3.5	mA
		$V_S, \text{Inputs} = 8\text{V}$			<b>4</b>	mA
		$V_S, \text{Inputs} = 8\text{V}, \text{post radiation}$			<b>4</b>	mA
$I_{IL\_18}$	Input Current Low	$V_S = 18\text{V}, \text{Inputs} = 0\text{V}$	-5	0.08	5	$\mu\text{A}$
		$V_S = 18\text{V}, \text{Inputs} = 0\text{V}$	<b>-10</b>		<b>10</b>	$\mu\text{A}$
		$V_S = 18\text{V}, \text{Inputs} = 0\text{V}, \text{post radiation}$	<b>-10</b>		<b>10</b>	$\mu\text{A}$
$I_{IH\_18}$	Input Current High	$V_S, \text{Inputs} = 18\text{V}$	-5	0.08	5	$\mu\text{A}$
		$V_S, \text{Inputs} = 18\text{V}$	<b>-10</b>		<b>10</b>	$\mu\text{A}$
		$V_S, \text{Inputs} = 18\text{V}, \text{post radiation}$	<b>-10</b>		<b>10</b>	$\mu\text{A}$
$I_{IL\_8}$	Input Current Low	$V_S = 8\text{V}, \text{Inputs} = 0\text{V}$	-5	0.08	5	$\mu\text{A}$
		$V_S = 8\text{V}, \text{Inputs} = 0\text{V}$	<b>-10</b>		<b>10</b>	$\mu\text{A}$
		$V_S = 8\text{V}, \text{Inputs} = 0\text{V}, \text{post radiation}$	<b>-10</b>		<b>10</b>	$\mu\text{A}$
$I_{IH\_8}$	Input Current High	$V_S, \text{Inputs} = 8\text{V}$	-5	0.08	5	$\mu\text{A}$
		$V_S, \text{Inputs} = 8\text{V}$	<b>-10</b>		<b>10</b>	$\mu\text{A}$
		$V_S, \text{Inputs} = 8\text{V}, \text{post radiation}$	<b>-10</b>		<b>10</b>	$\mu\text{A}$
$V_{OH}$	Output Voltage High	$V_S = 8\text{V}, I_{OUT} = 5\text{mA}$	$V_S - 0.75$	$V_S - 0.45$		V
			<b><math>V_S - 0.9</math></b>			V

# HS-4424DRH, HS4424DEH

**Electrical Specifications**  $V_{CC} = 8V, 12V, 18V, T_A = +25^\circ C$ , unless otherwise noted. **Boldface limits apply across the operating temperature range,  $-55^\circ C$  to  $+125^\circ C$ ; over radiation total ionizing dose. (Continued)**

PARAMETER	DESCRIPTION	TEST CONDITIONS	MIN (Note 5)	TYP	MAX (Note 5)	UNIT
V <sub>OL</sub>	Output Voltage Low	V <sub>S</sub> = 8V, I <sub>OUT</sub> = 5mA		0.45	0.8	V
					<b>0.8</b>	V
V <sub>OH</sub>	Output Voltage High	V <sub>S</sub> = 8V, I <sub>OUT</sub> = 50mA	V <sub>S</sub> - 0.95	V <sub>S</sub> - 0.75		V
			<b>V<sub>S</sub> - 1.1</b>			V
V <sub>OL</sub>	Output Voltage Low	V <sub>S</sub> = 8V, I <sub>OUT</sub> = 50mA		0.75	0.95	V
					<b>1.1</b>	V
V <sub>OH</sub>	Output Voltage High	V <sub>S</sub> = 12V, I <sub>OUT</sub> = 5mA	V <sub>S</sub> - 0.75	V <sub>S</sub> - 0.45		V
			<b>V<sub>S</sub> - 0.75</b>			V
V <sub>OL</sub>	Output Voltage Low	V <sub>S</sub> = 12V, I <sub>OUT</sub> = 5mA		0.45	0.8	V
					<b>0.8</b>	V
V <sub>OH</sub>	Output Voltage High	V <sub>S</sub> = 12V, I <sub>OUT</sub> = 50mA	V <sub>S</sub> - 0.95	V <sub>S</sub> - 0.75		V
			<b>V<sub>S</sub> - 1.1</b>			V
V <sub>OL</sub>	Output Voltage Low	V <sub>S</sub> = 12V, I <sub>OUT</sub> = 50mA		0.75	0.95	V
					<b>1.1</b>	V
V <sub>OH</sub>	Output Voltage High	V <sub>S</sub> = 18V, I <sub>OUT</sub> = 5mA	V <sub>S</sub> - 0.75	V <sub>S</sub> - 0.45		V
			<b>V<sub>S</sub> - 0.75</b>			V
V <sub>OL</sub>	Output Voltage Low	V <sub>S</sub> = 18V, I <sub>OUT</sub> = 5mA		0.45	0.8	V
					<b>0.8</b>	V
V <sub>OH</sub>	Output Voltage High	V <sub>S</sub> = 18V, I <sub>OUT</sub> = 50mA	V <sub>S</sub> - 0.95	V <sub>S</sub> - 0.75		V
			<b>V<sub>S</sub> - 1.1</b>			V
V <sub>OL</sub>	Output Voltage Low	V <sub>S</sub> = 18V, I <sub>OUT</sub> = 50mA		0.75	0.95	V
					<b>1.1</b>	V
V <sub>IH_18</sub>	Input Voltage High Threshold	V <sub>S</sub> = 18V	3			V
			<b>3.1</b>			V
V <sub>IL_18</sub>	Input Voltage Low Threshold	V <sub>S</sub> = 18V			0.8	V
					<b>0.8</b>	V
V <sub>IHYS_18</sub>	Input Voltage Threshold Hysteresis	V <sub>S</sub> = 18V	100			mV
V <sub>IH_12</sub>	Input Voltage High Threshold	V <sub>S</sub> = 12V	3			V
			<b>3.1</b>			V
V <sub>IL_12</sub>	Input Voltage Low Threshold	V <sub>S</sub> = 12V			0.8	V
					<b>0.8</b>	V
V <sub>HYS_12</sub>	Input Voltage Threshold Hysteresis	V <sub>S</sub> = 12V	100			mV
V <sub>IH_8</sub>	Input Voltage High Threshold	V <sub>S</sub> = 8V	3			V
			<b>3.1</b>			V
V <sub>IL_8</sub>	Input Voltage Low Threshold	V <sub>S</sub> = 8V			0.8	V
					<b>0.8</b>	V
V <sub>HYS_8</sub>	Input Voltage Threshold Hysteresis	V <sub>S</sub> = 8V	100			mV
UVLO <sub>r</sub>	Rising Undervoltage Lockout		7.2	7.5	7.8	V
			<b>6.9</b>		<b>7.95</b>	V
UVLO <sub>f</sub>	Falling Undervoltage Lockout		7.1	7.45	7.75	V
			<b>6.8</b>		<b>7.9</b>	V
HYS_UVLO	Undervoltage Lockout Hysteresis	UVLO <sub>r</sub> - UVLO <sub>f</sub>		23		mV
				24		mV
Min_PW	Minimum Input Pulse Width		100			ns

# HS-4424DRH, HS4424DEH

**Electrical Specifications**  $V_{CC} = 8V, 12V, 18V, T_A = +25^\circ C$ , unless otherwise noted. **Boldface limits apply across the operating temperature range,  $-55^\circ C$  to  $+125^\circ C$ ; over radiation total ionizing dose. (Continued)**

PARAMETER	DESCRIPTION	TEST CONDITIONS	MIN (Note 5)	TYP	MAX (Note 5)	UNIT	
<b>TRANSIENT RESPONSE</b>							
$t_r, t_f$	Rise Time 10% to 90% of $V_{OUT}$	$V_S = 18V, C_L = 4300pF$			75	ns	
		$V_S = 18V, C_L = 4300pF$			<b>95</b>	ns	
		$V_S = 18V, C_L = 4300pF, \text{ post radiation}$			<b>95</b>	ns	
	Fall Time 90% to 10% of $V_{OUT}$	$V_S = 18V, C_L = 4300pF$				75	ns
		$V_S = 18V, C_L = 4300pF$				<b>95</b>	ns
		$V_S = 18V, C_L = 4300pF, \text{ post radiation}$				<b>95</b>	ns
	Rise Time 10% to 90% of $V_{OUT}$	$V_S = 12V, C_L = 4300pF$				75	ns
		$V_S = 12V, C_L = 4300pF$				<b>95</b>	ns
		$V_S = 12V, C_L = 4300pF, \text{ post radiation}$				<b>95</b>	ns
	Fall Time 90% to 10% of $V_{OUT}$	$V_S = 12V, C_L = 4300pF$				75	ns
		$V_S = 12V, C_L = 4300pF$				<b>95</b>	ns
		$V_S = 12V, C_L = 4300pF, \text{ post radiation}$				<b>95</b>	ns
Rise Time 10% to 90% of $V_{OUT}$	$V_S = 8V, C_L = 4300pF$				75	ns	
	$V_S = 8V, C_L = 4300pF$				<b>95</b>	ns	
	$V_S = 8V, C_L = 4300pF, \text{ post radiation}$				<b>95</b>	ns	
Fall Time 90% to 10% of $V_{OUT}$	$V_S = 8V, C_L = 4300pF$				75	ns	
	$V_S = 8V, C_L = 4300pF$				<b>95</b>	ns	
	$V_S = 8V, C_L = 4300pF, \text{ post radiation}$				<b>95</b>	ns	
$t_{PHL}, t_{PLH}$	50% of Rising Input to 10% of Rising Output	$V_S = 18V, C_L = 4300pF$			200	ns	
		$V_S = 18V, C_L = 4300pF$			<b>300</b>	ns	
		$V_S = 18V, C_L = 4300pF, \text{ post radiation}$			<b>300</b>	ns	
	50% of Falling Input to 90% of Falling Output	$V_S = 18V, C_L = 4300pF$				200	ns
		$V_S = 18V, C_L = 4300pF$				<b>300</b>	ns
		$V_S = 18V, C_L = 4300pF, \text{ post radiation}$				<b>300</b>	ns
	50% of Rising Input to 10% of Rising Output	$V_S = 12V, C_L = 4300pF$				250	ns
		$V_S = 12V, C_L = 4300pF$				<b>350</b>	ns
		$V_S = 12V, C_L = 4300pF, \text{ post radiation}$				<b>350</b>	ns
	50% of Falling Input to 90% of Falling Output	$V_S = 12V, C_L = 4300pF$				250	ns
		$V_S = 12V, C_L = 4300pF$				<b>350</b>	ns
		$V_S = 12V, C_L = 4300pF, \text{ post radiation}$				<b>350</b>	ns
	50% of Rising Input to 10% of Rising Output	$V_S = 8V, C_L = 4300pF$				300	ns
		$V_S = 8V, C_L = 4300pF$				<b>400</b>	ns
		$V_S = 8V, C_L = 4300pF, \text{ post radiation}$				<b>400</b>	ns
	50% of Falling Input to 90% of Falling Output	$V_S = 8V, C_L = 4300pF$				300	ns
		$V_S = 8V, C_L = 4300pF$				<b>400</b>	ns
		$V_S = 8V, C_L = 4300pF, \text{ post radiation}$				<b>400</b>	ns

NOTE:

- Compliance to datasheet limits is assured by one or more methods; production test, characterization and/or design.

# HS-4424DRH, HS4424DEH

## Typical Performance Curves

Unless otherwise specified,  $V_S = 8V, 12V, 18V, C_L = 4300pF, T_A = +25^\circ C$ .

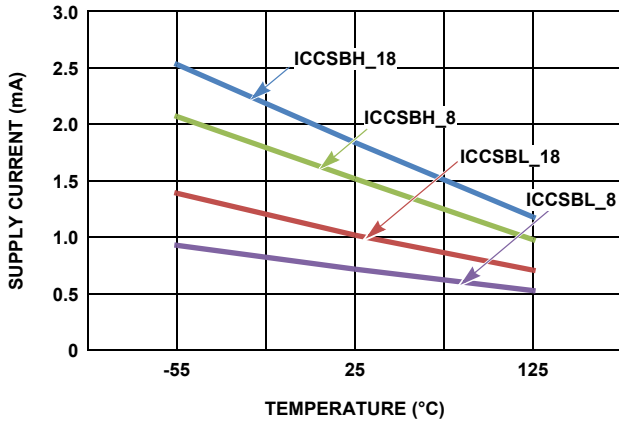

FIGURE 5. SUPPLY CURRENT vs TEMPERATURE

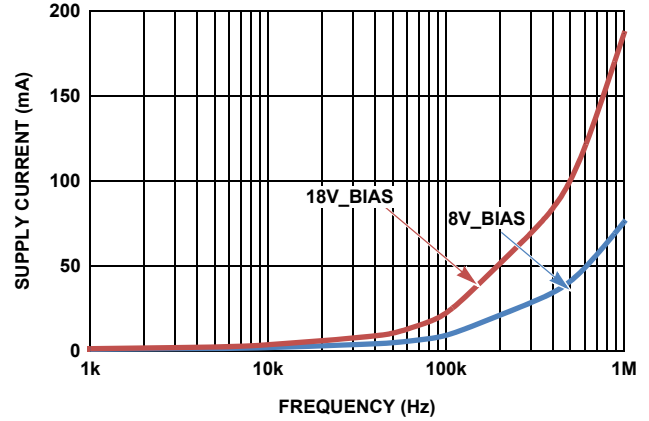

FIGURE 6. SUPPLY CURRENT vs DUAL SWITCHING AT FREQUENCY

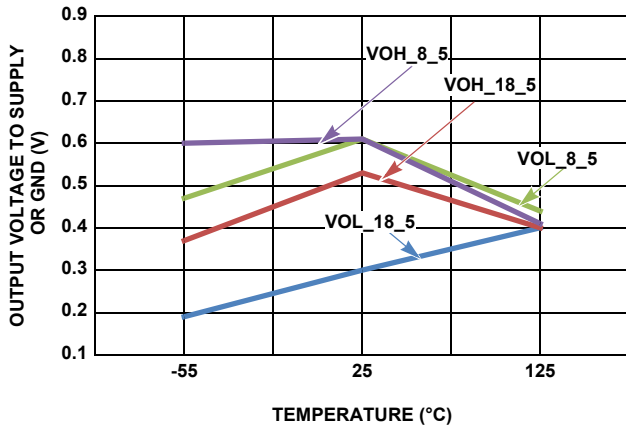

FIGURE 7. OUTPUT VOLTAGE vs TEMPERATURE (5mA)

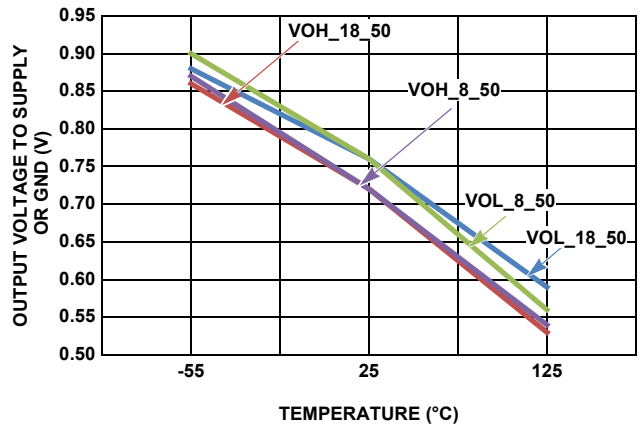

FIGURE 8. OUTPUT VOLTAGE vs TEMPERATURE (50mA)

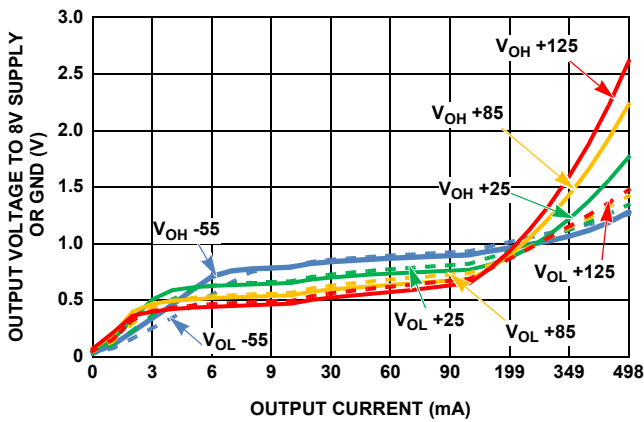

FIGURE 9. OUTPUT VOLTAGE vs OUTPUT CURRENT

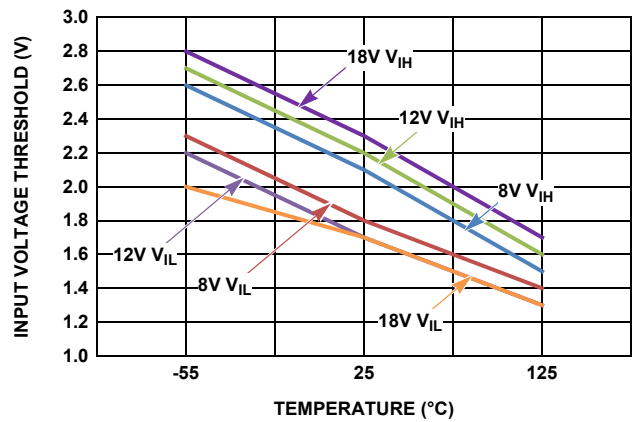

FIGURE 10. INPUT VOLTAGE THRESHOLD vs TEMPERATURE AND BIAS VOLTAGE

# HS-442DRH, HS4424DEH

## Typical Performance Curves

Unless otherwise specified,  $V_S = 8V, 12V, 18V, C_L = 4300pF, T_A = +25^\circ C$ . (Continued)

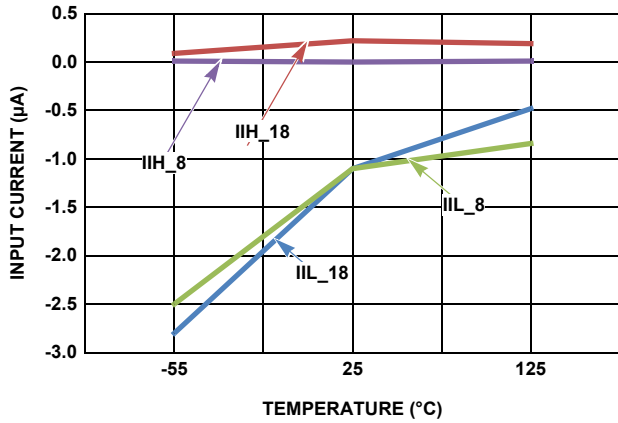

FIGURE 11. INPUT CURRENT vs TEMPERATURE AND BIAS VOLTAGE

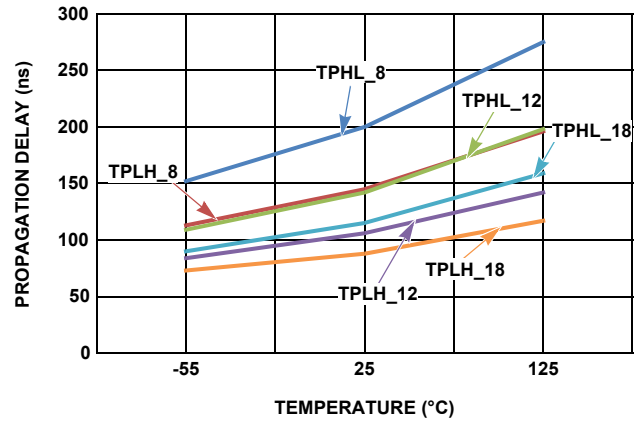

FIGURE 12. PROPAGATION DELAY vs TEMPERATURE

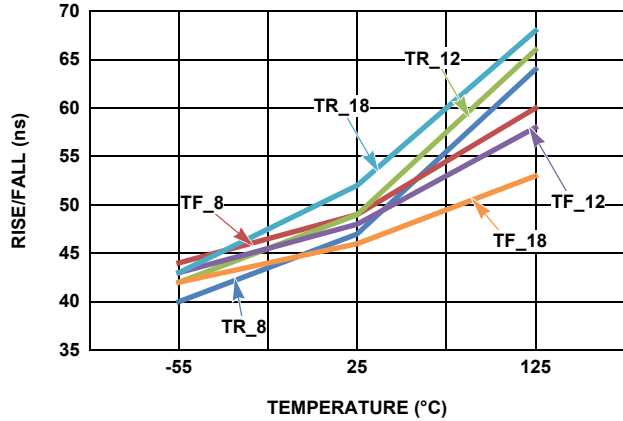

FIGURE 13. RISE/FALL TIME vs TEMPERATURE

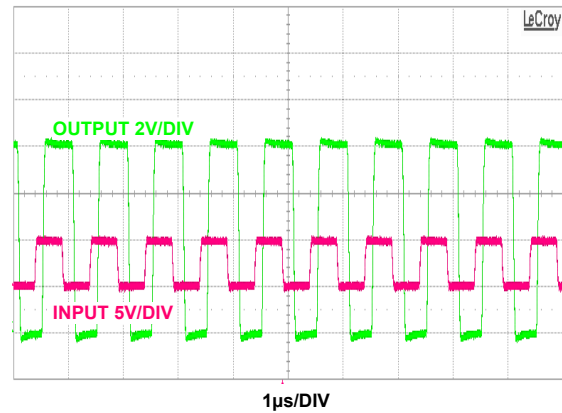

FIGURE 14. 1MHz AT 8V BIAS

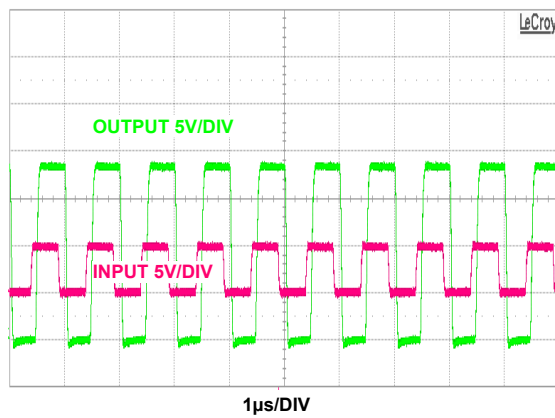

FIGURE 15. 1MHz AT 18V BIAS

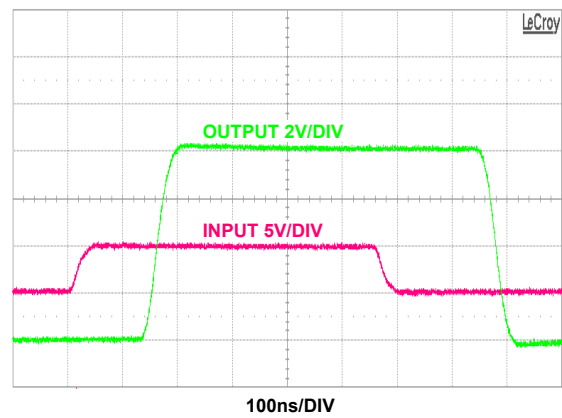

FIGURE 16. 8V RISING/FALLING PROPAGATION TIME



# HS-4424DRH, HS4424DEH

## Typical Performance Curves Unless otherwise specified, $V_S = 8V, 12V, 18V, C_L = 4300pF, T_A = +25^\circ C$ . (Continued)

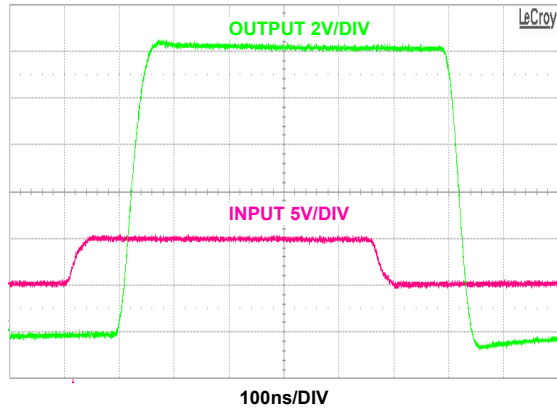

FIGURE 17. 12V RISING/FALLING PROPAGATION TIME

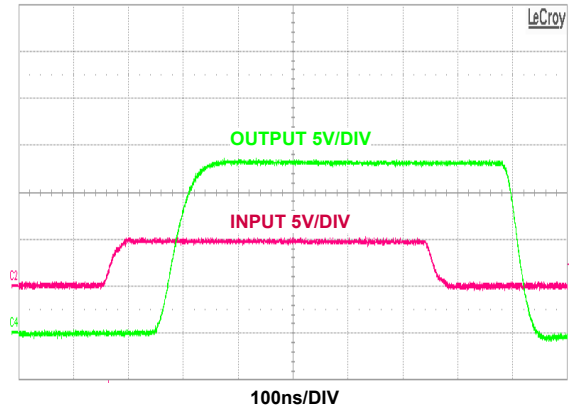

FIGURE 18. 18V RISING/FALLING PROPAGATION TIME

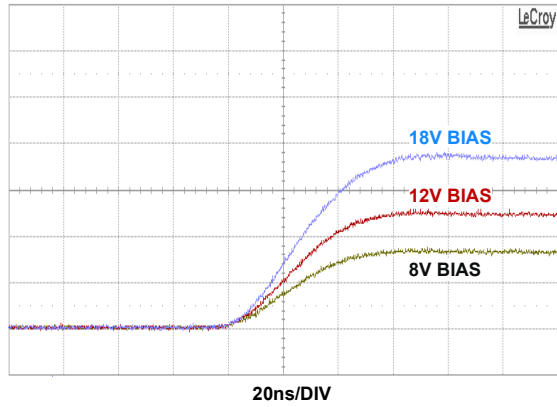

FIGURE 19. RISE TIME

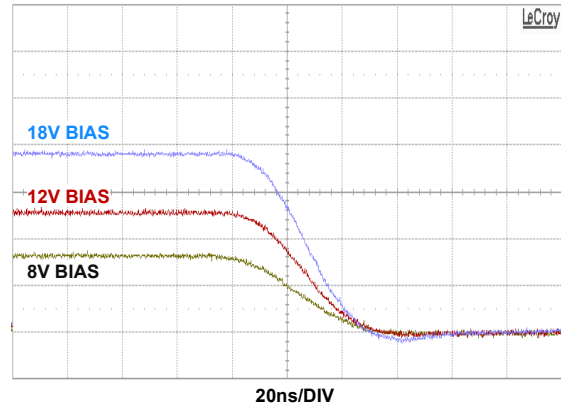

FIGURE 20. FALL TIME

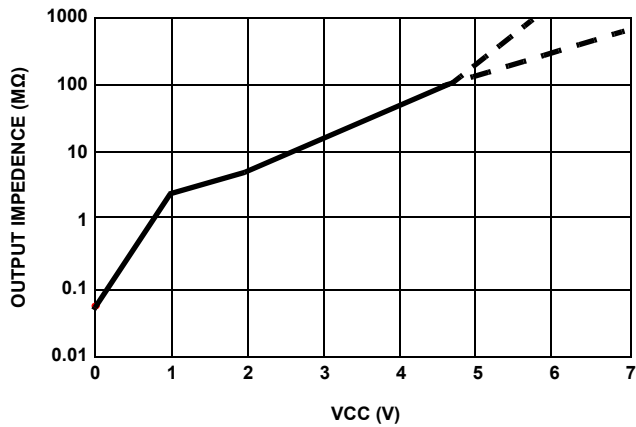

FIGURE 21. UVLO OUTPUT HIGH Z vs VCC

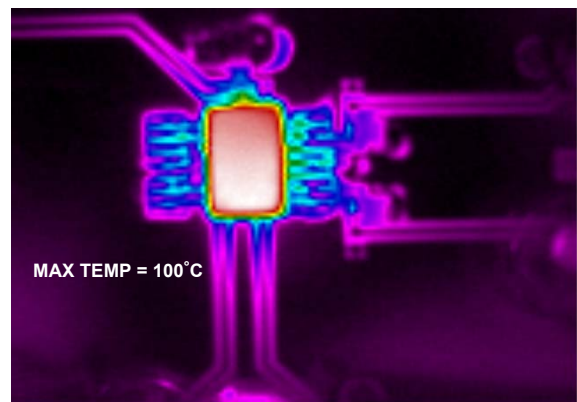

FIGURE 22. 18V, 1MHz OPERATING IR TEMP

# HS-442DRH, HS4424DEH

## Post High, Low Dose Rate Radiation Characteristics

Unless otherwise specified,  $V_S = 1.2V$ ,  $T_A = +25^\circ C$ . This data is typical mean test data post 300kRAD (Si) radiation exposure at a high dose exposure rate of 50 to 300rad(Si)/s and post 50kRAD (Si) radiation exposure at a high dose exposure rate of <10mrad(Si)/s. This data is intended to show typical parameter shifts due to high dose rate radiation. These are not limits nor are they guaranteed.

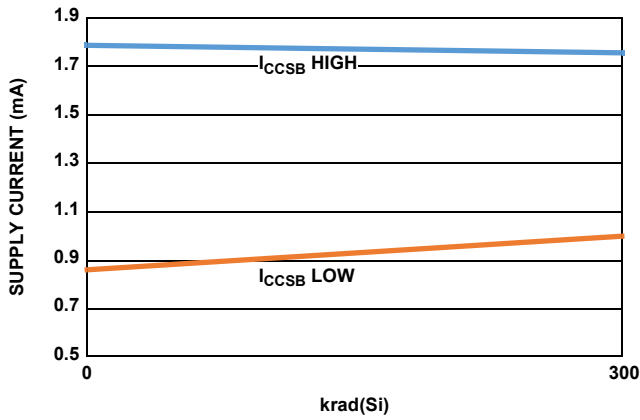

FIGURE 23. 18V SUPPLY CURRENT vs HDR RADIATION

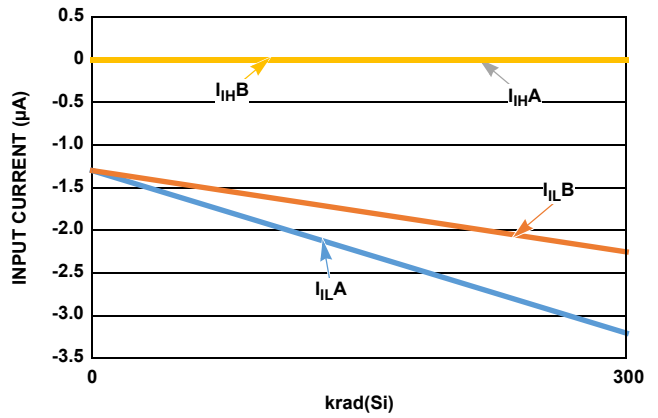

FIGURE 24. 18V INPUT CURRENT vs HDR RADIATION

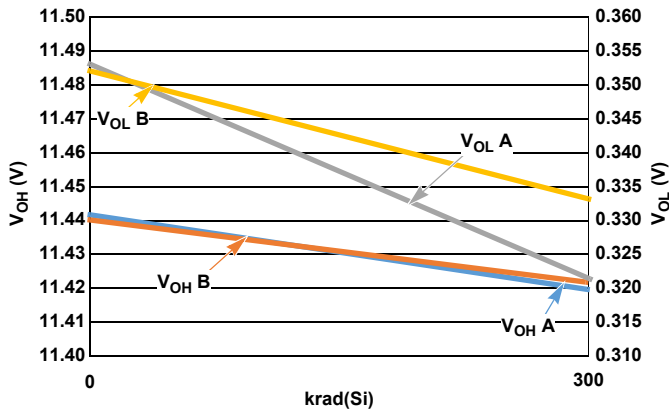

FIGURE 25. OUTPUT VOLTAGE vs HDR RADIATION

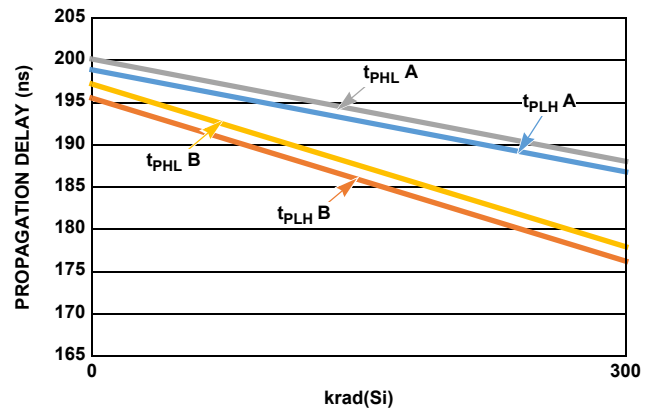

FIGURE 26. PROPAGATION DELAY vs HDR RADIATION

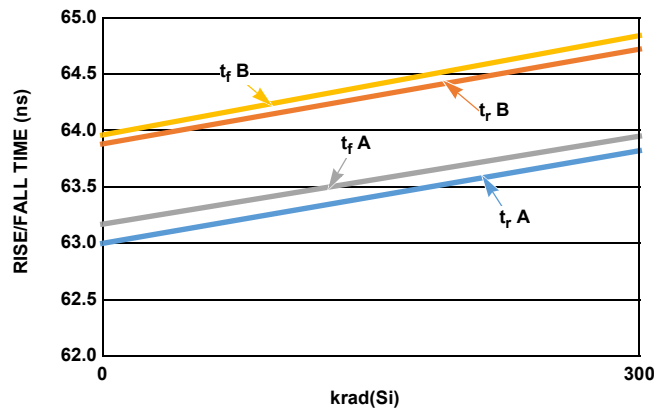

FIGURE 27. RISE/FALL TIME vs HDR RADIATION

# HS-4424DRH, HS4424DEH

**Post High, Low Dose Rate Radiation Characteristics** Unless otherwise specified,  $V_S = 12V$ ,  $T_A = +25^\circ C$ . This data is typical mean test data post 300kRAD (Si) radiation exposure at a high dose exposure rate of 50 to 300rad(Si)/s and post 50kRAD (Si) radiation exposure at a high dose exposure rate of <10mrad(Si)/s. This data is intended to show typical parameter shifts due to high dose rate radiation. These are not limits nor are they guaranteed. **(Continued)**

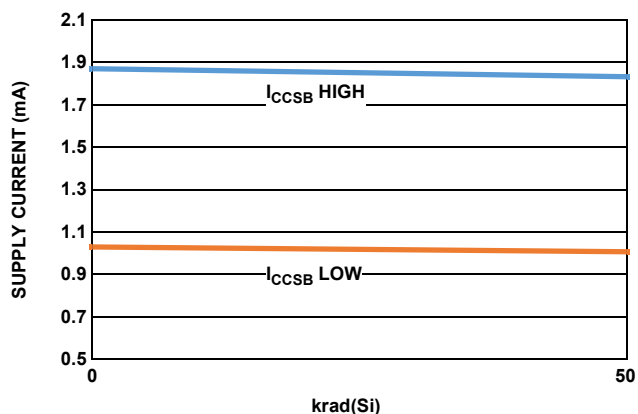

FIGURE 28. 18V SUPPLY CURRENT vs LDR RADIATION

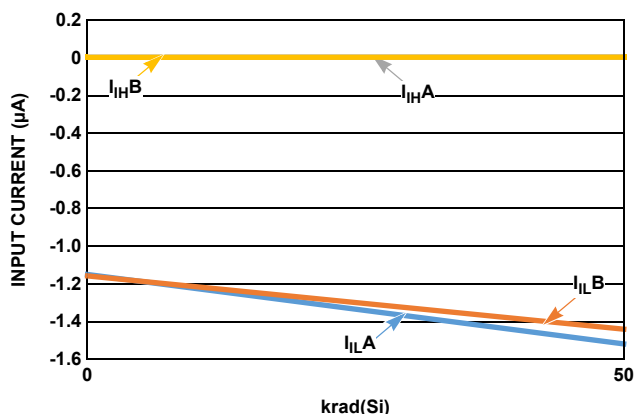

FIGURE 29. 18V INPUT CURRENT vs LDR RADIATION

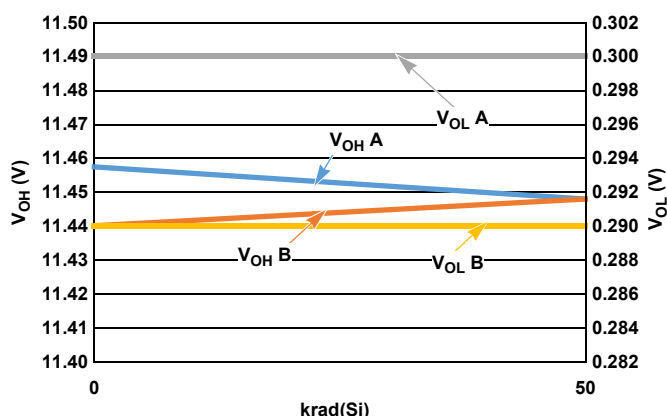

FIGURE 30. OUTPUT VOLTAGE vs LDR RADIATION

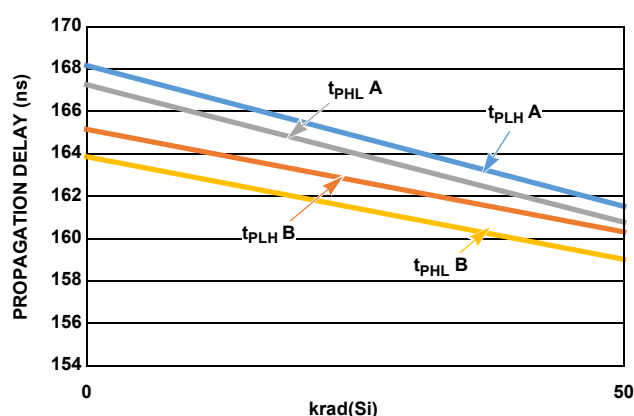

FIGURE 31. PROPAGATION DELAY vs LDR RADIATION

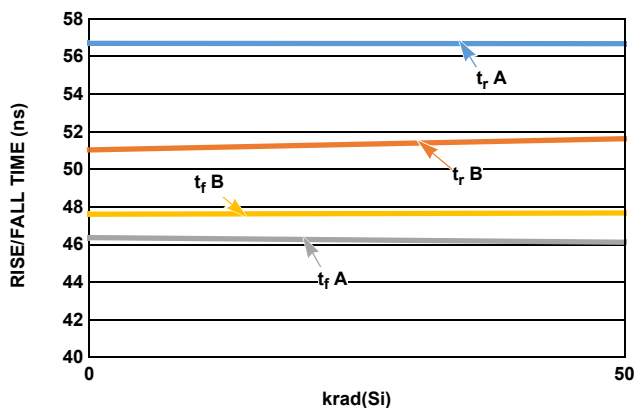

FIGURE 32. RISE/FALL TIME vs LDR RADIATION

## Applications Information

### Functional Description

The HS-4424DxH MOSFET drivers are designed for easy implementation with a PWM controller, such as the HS-1825ARH, as the input control signal driver. The HS-4424DxH consist of two independent drivers sharing bias voltage and ground connections at the die level.

### Undervoltage Lockout and Operating Voltage Range

The HS-4424DxH have a guaranteed UVLO of <8V across the operating temperature range. All devices are recommended to operate up to and are characterized and tested at a bias of 18V. The UVLO feature ensures that the internal MOSFET drivers have sufficient gate drive to operate in their saturated mode. When in a UVLO condition the HS-4424DxH outputs are put into a high impedance tri-stated mode.

Characterization and testing occurs (as appropriate) at 8V, 12V and 18V and across the -55°C to +125°C operating temperature range.

### Input Characteristics

The HS-4424DxH inputs are designed to be used with low voltage level signals (<1V for a low input level and >3V for a high input level) and also be capable of accepting input voltages up to the VCC level.

### Output Buffer

The HS-4424DxH output buffers are designed to drive >2A of peak output current into high capacitance loads and can be paralleled to increase the output current capability.

The output buffer uses a final drive stage comprised of a PNP lower and NPN upper complimentary pair of transistors for the high output current drive. To enhance the pull-up and pull-down of this bipolar pair, they are each paralleled with MOS devices to do so.

## Power Dissipation and Junction Temperature

It is possible to exceed the +150°C maximum recommended junction temperature under certain load and power supply conditions.

Calculate power dissipation using [Equation 1](#):

$$P_d = V \cdot I + 2 \cdot C \cdot V^2 \cdot f \quad (\text{EQ. 1})$$

Where

$P_d$  = Power dissipation

$V$  = Supply voltage

$I$  = Operating supply current

$C$  = Load capacitance

$f$  = Operating frequency

Calculate junction temperature  $T_J$  using [Equation 2](#):

$$T_J = P_d \cdot \theta_{JC} + T_C \quad (\text{EQ. 2})$$

Where

$T_J$  = Junction temperature

$P_d$  = Power dissipation

$\theta_{JC}$  = Junction-to-case thermal resistance

$T_C$  = Case temperature

## PCB Layout Guidelines

Use a ground plane in the PCB design, connect GND A and GND B pins directly to the ground plane in the same area, preferably close to the IC. Reference all input circuitry including IN A and IN B to a common node and reference all output circuitry including all OUT A and OUT B pins to a common node.

Bypass each VCC pin to the ground plane with a 0.047µF ceramic chip capacitor in parallel with a 4.7µF low ESR solid tantalum capacitor.

Clamp both OUT pins to VCC, each with a single diode. The 1n5819 (1A, 40V) Schottky diode is recommended.

# HS-4424DRH, HS4424DEH

## Die Characteristics

### Die Dimensions

4890 $\mu$ m x 3370 $\mu$ m (193mils x 133mils)  
Thickness: 483 $\mu$ m  $\pm$ 25.4 $\mu$ m (19mils  $\pm$ 1mil)

### Interface Materials

#### GLASSIVATION

Type: PSG (Phosphorous Silicon Glass)  
Thickness: 8.0k $\text{Å}$   $\pm$ 1.0k $\text{Å}$

#### TOP METALLIZATION

Type: AlSiCu  
Thickness: 16.0k $\text{Å}$   $\pm$ 2k $\text{Å}$

#### BACKSIDE FINISH

Silicon

#### PROCESS

Radiation Hardened Silicon Gate (DI)

## Assembly Related Information

### SUBSTRATE POTENTIAL

Floating (DI)

### LID POTENTIAL

Floating

### Additional Information

#### WORST CASE CURRENT DENSITY

$< 2 \times 10^5$  A/cm<sup>2</sup>

#### TRANSISTOR COUNT

125

### Weight of Packaged Device

0.591 grams (typical)

### Lid Characteristics

Finish: Gold

Case isolation to any lead: 20 x 10<sup>9</sup> $\Omega$  (minimum)

## Metallization Mask Layout

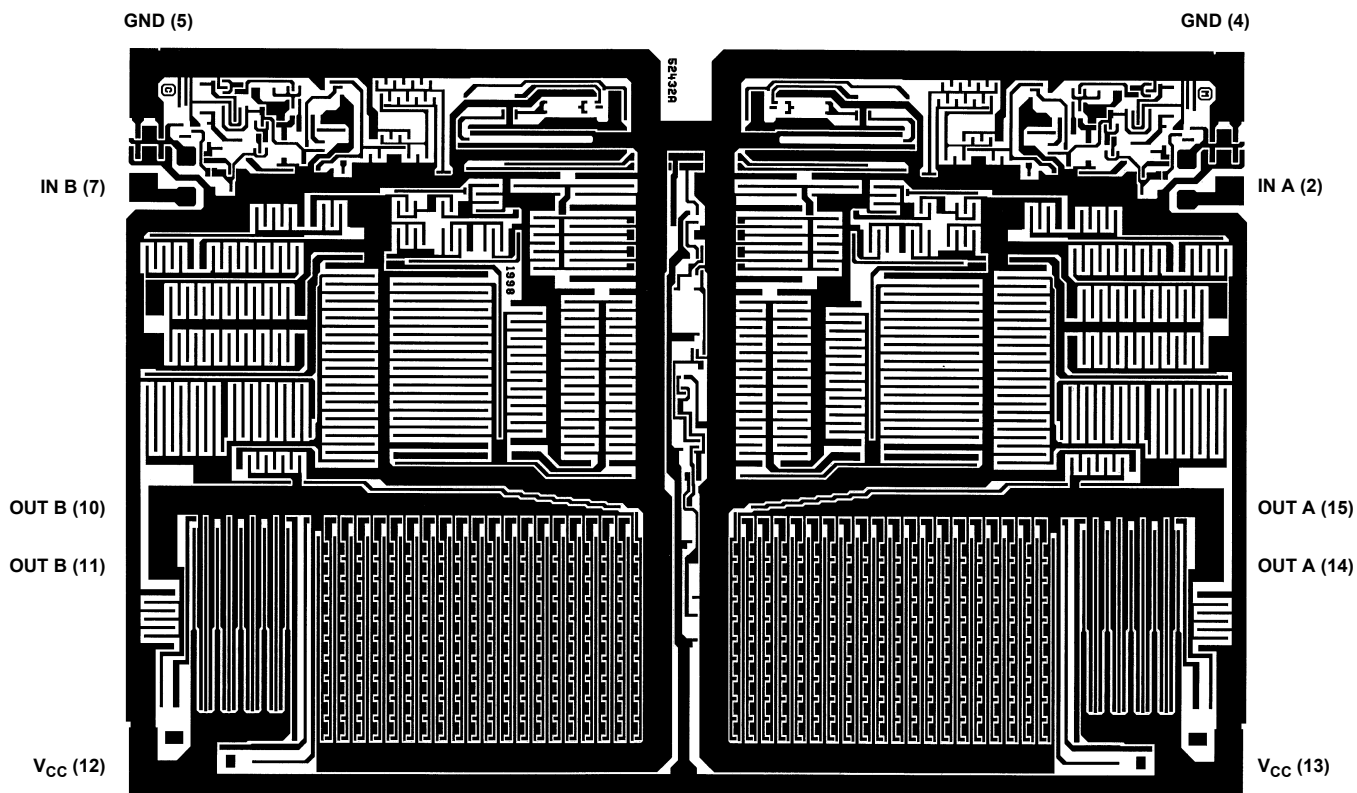

# HS-4424DRH, HS4424DEH

## Revision History

The revision history provided is for informational purposes only and is believed to be accurate, but not warranted. Please go to the web to make sure that you have the latest revision.

DATE	REVISION	CHANGE
October 15, 2015	FN8747.2	Added part number HS-4424DEH throughout datasheet.
July 1, 2015	FN8747.1	Abs Max ratings on page 4 - removed abs max input current and related text on page 13. ESD Ratings - changed Machine Model from: 1kV to: 200V and Charged Device Model from: 4kV to: 750V Changed over temp limits for UVLO Rising from: MIN/MAX 7.0/7.9 to: 6.9/7.95 and Falling MIN/MAX from: 6.9/7.85 to: 6.8/7.9. Changed over temp 8V, 5mA VOH limit MIN from $V_S - 0.75$ to $V_S - 0.9$ .
June 8, 2015	FN8747.0	Initial Release

## About Intersil

Intersil Corporation is a leading provider of innovative power management and precision analog solutions. The company's products address some of the largest markets within the industrial and infrastructure, mobile computing and high-end consumer markets.

For the most updated datasheet, application notes, related documentation and related parts, please see the respective product information page found at [www.intersil.com](http://www.intersil.com).

You may report errors or suggestions for improving this datasheet by visiting [www.intersil.com/ask](http://www.intersil.com/ask).

Reliability reports are also available from our website at [www.intersil.com/support](http://www.intersil.com/support).

For additional products, see [www.intersil.com/en/products.html](http://www.intersil.com/en/products.html)

Intersil products are manufactured, assembled and tested utilizing ISO9001 quality systems as noted in the quality certifications found at [www.intersil.com/en/support/qualandreliability.html](http://www.intersil.com/en/support/qualandreliability.html)

*Intersil products are sold by description only. Intersil Corporation reserves the right to make changes in circuit design, software and/or specifications at any time without notice. Accordingly, the reader is cautioned to verify that data sheets are current before placing orders. Information furnished by Intersil is believed to be accurate and reliable. However, no responsibility is assumed by Intersil or its subsidiaries for its use; nor for any infringements of patents or other rights of third parties which may result from its use. No license is granted by implication or otherwise under any patent or patent rights of Intersil or its subsidiaries.*

For information regarding Intersil Corporation and its products, see [www.intersil.com](http://www.intersil.com)

# HS-4424DRH, HS4424DEH

## Package Outline Drawing

K16.A

16 LEAD CERAMIC METAL SEAL FLATPACK PACKAGE

Rev 2, 1/10

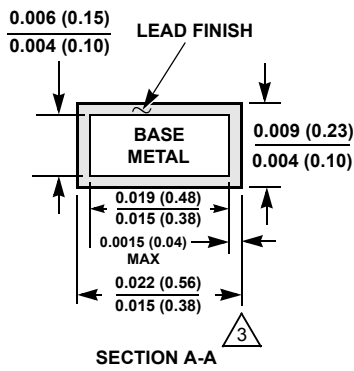
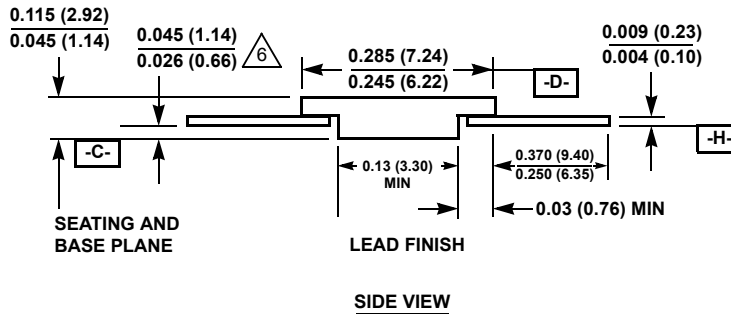
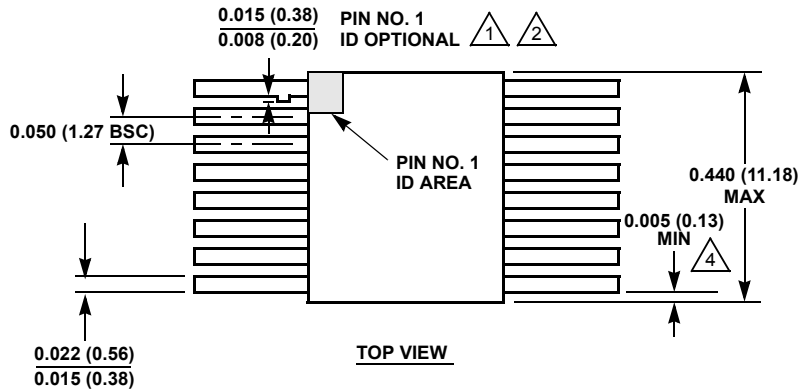

**NOTES:**

1. Index area: A notch or a pin one identification mark shall be located adjacent to pin one and shall be located within the shaded area shown. The manufacturer's identification shall not be used as a pin one identification mark. Alternately, a tab may be used to identify pin one.
2. If a pin one identification mark is used in addition to a tab, the limits of the tab dimension do not apply.
3. The maximum limits of lead dimensions (section A-A) shall be measured at the centroid of the finished lead surfaces, when solder dip or tin plate lead finish is applied.
4. Measure dimension at all four corners.
5. For bottom-brazed lead packages, no organic or polymeric materials shall be molded to the bottom of the package to cover the leads.
6. Dimension shall be measured at the point of exit (beyond the meniscus) of the lead from the body. Dimension minimum shall be reduced by 0.0015 inch (0.038mm) maximum when solder dip lead finish is applied.
7. Dimensioning and tolerancing per ANSI Y14.5M - 1982.
8. Controlling dimension: INCH.