

FEATURES

- -55°C to +125°C
- 12 to 40 VDC input
- Sync on HUM-70
- Reduce hold-up capacitance by 80%
- Powers DC/DC converters with 28 Vin nominal
- Hold-up time
HUM-40 15 μ s/ μ F
HUM-70 8.6 μ s/ μ F
- Low power flag
- Inhibit function

HOLD UP MODULE 28 VOLT INPUT



HUMMER MODULE 40 OR 70 WATTS

MODELS	
POWER OUTPUT	
HUM-40 40 watts	HUM-70 70watts

- Size (max.): HUM-40, non flanged, Case F2
1.950 x 1.350 x 0.415 inches (49.53 x 34.29 x 10.54 mm)
HUM-40, flanged, Case J2
2.720 x 1.350 x 0.415 inches (69.09 x 34.29 x 10.54 mm)
HUM-70 Case U1
1.505 x 3.005 x 0.400 inches (38.23 x 76.33 x 10.16 mm)
See Section B8, cases F2, J2, and U1, for dimensions.
- Weight: HUM-40 50 grams max. (flanged 60 grams typical)
HUM-70 70 grams max.
- Screening: Standard or ES. See Section C2 for screening option and Section A5 for ordering information.

DESCRIPTION

Interpoint's HUMMER™ Hold-Up Module Series provides a single product solution to the problem of maintaining electronic system operation during input power drop-out, typically reducing bulk capacitance requirements by more than 80%. The HUMMER module is compatible with the Interpoint DC/DC converters in Section B1 that have a 28 VDC nominal input and a high input line of 40 VDC.

The traditional procedure for providing hold-up during power loss is to buffer the device with enough bulk capacitance to allow a controlled shutdown to occur or an alternative power source to be brought on line. The problem with this approach is that very large capacitor banks are required because the capacitors are charged at the relatively low voltage at which power fails.

The HUMMER Hold-Up Module provides an alternative with two important advantages: 1) it effectively reduces the low line voltage for normal DC/DC converter operation to 12 VDC thereby reducing power drop-out events, and 2) it charges hold-up capacitors to 40 volts, reducing the capacitance needed to produce a given hold-up time.

GENERAL OPERATION

The HUMMER module and two external components (a hold-up capacitor and a diode) are connected between the line source and the DC/DC converter as shown in Figure 3 (HUMMER Module System Block Diagram.) If an EMI filter is employed, the HUMMER module is connected between the filter and the converter). The module first charges the external capacitor to 40 volts, and then allows the converter to operate off the line voltage. When the line voltage drops to between 12 to 18 VDC, a boost converter in the module supplies an output at the capacitor charging voltage (40 VDC). If power fails (the input voltage drops below 12 VDC), the converter is powered from the external hold-up capacitor.

HUMMER SERIES 40 OR 70 WATTS

HOLD UP MODULE

ABSOLUTE MAXIMUM RATINGS

Output Power

- HUM-40 40 watts
- * HUM-70 70 watts

Input Voltage Range

- 12 to 50 continuous
- 80 V for up to 50 ms

Lead Soldering Temperature (10 sec per lead)

- 300°C

Storage Temperature Range (Case)

- -65°C to +135°C

SYNC AND INHIBIT

Sync (HUM-70 only)

- Range 525 min to 625 max kHz
- Duty cycle 40% min to 60% max
- Logic low 0.8V, max
- Logic high 4.5 V, min
- Referenced to input common
- If sync is not used, leave unconnected

Inhibit TTL Open Collector

- Logic low (output disabled)
Logic low voltage 0.8 V max
Inhibit pin current 15 mA
- Referenced to input common
- Logic high (output enabled)
Open circuit voltage 10 V typical

RECOMMENDED OPERATING CONDITIONS

Input Voltage Range

- 12 to 40 VDC continuous

Case Operating Temperature (Tc)

- -55 to +125°C full power

Electrical Characteristics: 25°C Tc, 28 VDC Vin, 100% load, free run, unless otherwise specified.

PARAMETER	CONDITION	HUM-40		HUM-70		UNITS
		MIN	MAX	MIN	MAX	
OUTPUT VOLTAGE	CEXT TERMINAL	39	40	39	40	VDC
OUTPUT POWER	CONTINUOUS	—	40	—	70	W
	PEAK, 2 SEC	—	60	—	100	
INPUT VOLTAGE	CONTINUOUS	12	50	12	50	VDC
	TRANSIENT 50 ms	—	80	—	80	V
INPUT RIPPLE CURRENT	2 MHz Bandwidth	—	100	—	100	mA p-p
INPUT CURRENT	V _{IN} = 28V, VCS OPEN	—	90	—	90	mA
	V _{IN} = 28V, INHIBITED	—	10	—	10	
	V _{IN} = 12V, FULL LOAD	—	4.6	—	8.6	A
EFFICIENCY	V _{IN} = 40V, FULL LOAD	92	—	92	—	%
	V _{IN} = 22V, FULL LOAD	87	—	87	—	
	V _{IN} = 12V, FULL LOAD	80	—	80	—	
HOLD-UP TIME	FULL LOAD	15	—	8.6	—	μs/μF
POWER FAIL FLAG THRESHOLD	HIGH, OPEN CIRCUIT	14.0	14.5	14.0	14.5	VDC
	LOW, SHORT RETURN	11.5	12.0	11.5	12.0	
CAPACITOR VOLTAGE CONTROLLED SWITCH	OPEN	22	24	22	24	VDC
	CLOSED	18	19	18	19	
CAP CHARGED FLAG THRESHOLD	HIGH, OPEN CIRCUIT	34	36	34	36	VDC
	LOW, SHORT RETURN	19.5	20.5	19.5	20.5	

Notes

1. Full load for specifications is 40 W for HUM-40 and 70 W for HUM-70.

HOLD UP MODULE

HUMMER SERIES 40 OR 70 WATT

PIN OUT		
Pin	HUM-40 (40 Watt)	HUM-70 (70 Watt)
1	No connection	Sync
2	VCS (Voltage Control Switch)	Cap Charged Flag
3	+ CEXT (Ext. Capacitor, Positive)	Inhibit
4	CEXT Return (Ext. Capacitor, Return)	Power Fail Flag
5	Input Common	No connection
6	Positive Input	No connection
7	Case Ground	VCS (Voltage Control Switch)
8	Cap Charged Flag	+ CEXT (Ext. Capacitor, Positive)
9	Inhibit	CEXT Return (Ext. Capacitor, Return)
10	Power Fail Flag	Input Common
11	N/A	Positive Input
12	N/A	No connection

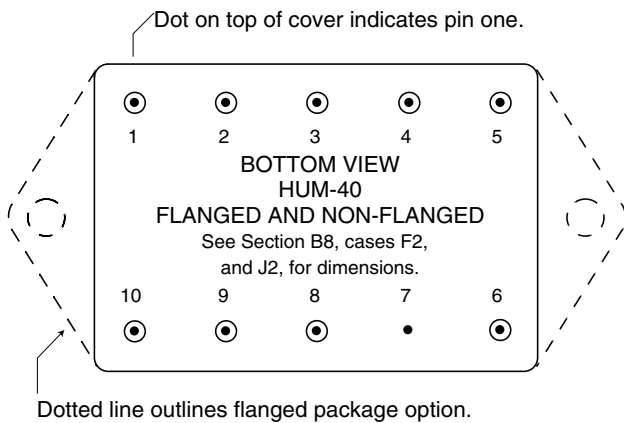

FIGURE 1: HUM-40 PIN OUT

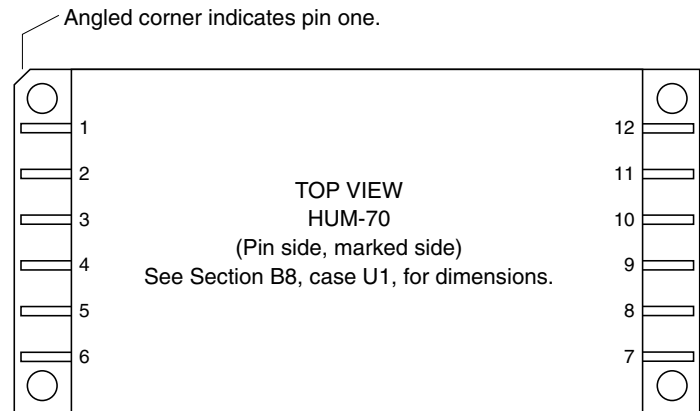
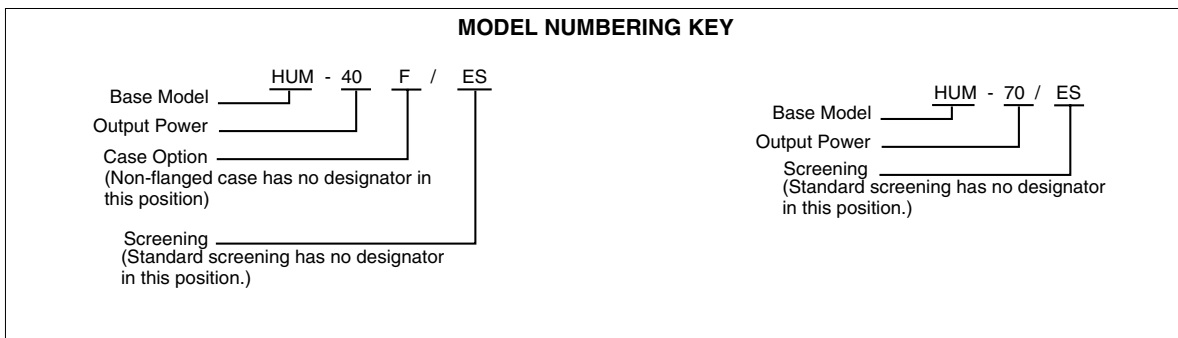

FIGURE 2: HUM-70 PIN OUT



HUMMER SERIES 40 OR 70 WATT

HOLD UP MODULE

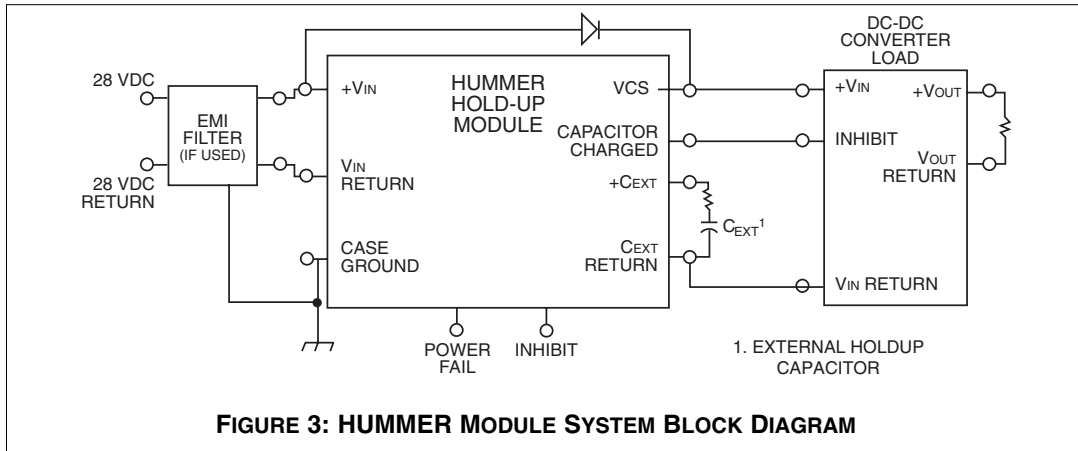

FIGURE 3: HUMMER MODULE SYSTEM BLOCK DIAGRAM

DETAILED OPERATIONAL DESCRIPTION

The detailed operation of the HUMMER module is divided into 4 operations: Initialization and Charging, Normal Operation, Low Line Operation, and Power Fail Operation. For details, refer to the following text, Figure 4 (HUMMER Module Block Diagram) and Figure 5 (HUMMER Module Signal Diagram).

1. INITIALIZATION AND CHARGING

As the input voltage ramps up to 8 to 10 volts, the internal HUMMER module circuits are biased to provide correct output states on all flags. As the input reaches 14 VDC, the Power Fail flag (active low) is released, the voltage control switch (VCS) is closed, and the module begins operating in a boost mode to charge the external capacitor to 40 volts. At this point, if the recommended connection has been made between the Capacitor Charged pin and the inhibit pin of the converter as shown in Figure 3, all of the module energy is dedicated to charging the capacitor and the converter will be inhibited until the capacitor charge reaches 36 V. If this connection has not been made, the energy available to charge the capacitor will be the difference between the current required by the converter's load and the current capacity of the HUMMER module.

Note: The HUMMER module is rated at a total operating power more than its output rating in order to allow it to both deliver a full load and to continue charging the external capacitor (the HUM-40, for example, is rated at 40 W output and 60 W total operating power, allowing it to deliver 40 W to a load and charge a capacitor at 10 to 20 J/sec). However, if the input voltage ramps up slowly into a full converter load, the total power drawn at low voltage could send the module into current limit which would shut the unit down.

When the input voltage reaches approximately 22 VDC, the VCS is opened, isolating the stored charge on the external capacitor and allowing the converter to operate directly from the input power bus via the external system diode (unless the converter is still inhibited by the connection between the Capacitor Charged pin and converter's inhibit pin) while the capacitor continues to charge.

When the charge on the external capacitor reaches approximately 35 volts (80% of a full charge), the Capacitor Charged flag will be asserted (removing the inhibit from the converter if applicable) and the HUMMER module will be in normal operation.

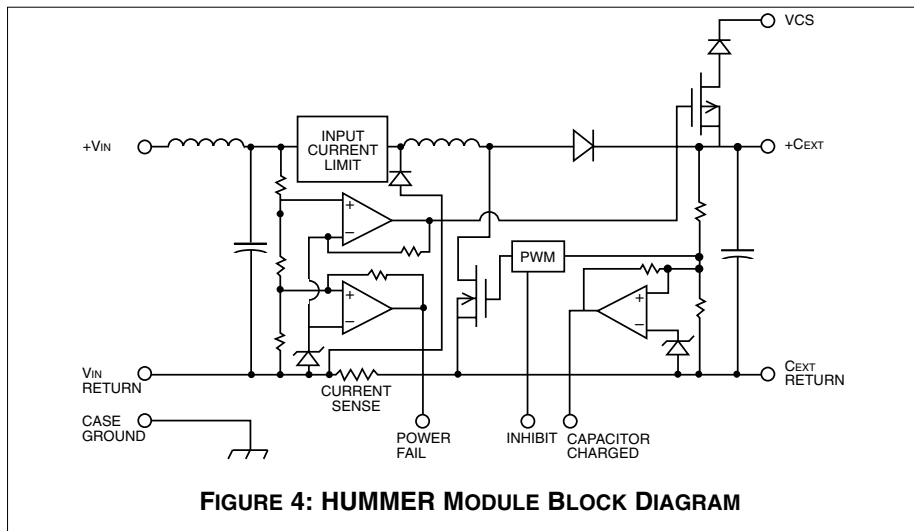

FIGURE 4: HUMMER MODULE BLOCK DIAGRAM

2. NORMAL OPERATION

Normal operation continues with the capacitor charged and the input line voltage between 18 and 40 VDC. During this time, the converter will operate from the line voltage through the external diode. When the external capacitor reaches its final charge of 40 volts, the HUMMER module enters an idle state, consuming only enough power to keep the capacitor charged. Idle state power for the module is approximately 1 watt.

Note: The HUMMER module itself can sustain continuous voltages of up to 50 VDC and voltage spikes of 80 volts for up to 50 msec, and it will pass these voltages on to the converter through the external bypass diode. If these ratings exceed the rating of the converter, care should be taken to control the line voltage to prevent damage to the converter.

Normal Operation will continue indefinitely until the input voltage drops below 18 VDC.

3. LOW LINE OPERATION

Low line operation occurs when the input voltage drops to a range between 18 and 12 volts. When the voltage reaches 18 VDC, the HUMMER module's VCS closes and then operates in a boost mode. In this mode, the HUMMER module supplies 40 VDC through VCS to the converter, and at the same time maintains the charge on the capacitor. The module will operate indefinitely in this low line region until the input line voltage drops below 12 VDC.

4. POWER FAIL OPERATION

When the input line voltage drops to 12 VDC, the Power Fail flag is asserted (pulled low) and the HUMMER module's boost mode is disabled. At this point, the converter load is powered by the stored energy in the external capacitor. When the voltage on the external capacitor falls to 20 VDC, the Capacitor Charged flag is released (pulled low), indicating that 90% of the usable stored energy has been depleted. If the connection has been made between the Capacitor Charged pin and the converter's Inhibit pin, the converter will also be inhibited.

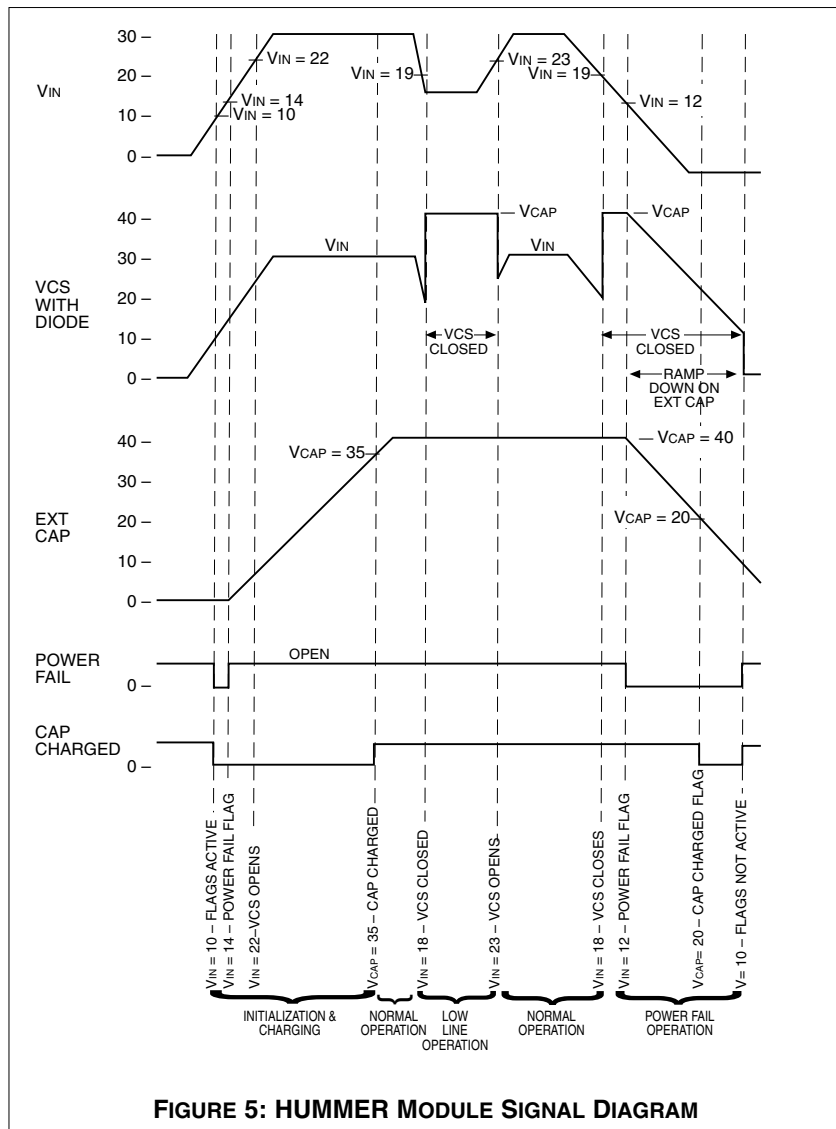

HUMMER SERIES 40 OR 70 WATT

HOLD UP MODULE

PIN CONNECTIONS

EXTERNAL CAPACITOR SELECTION

The external capacitor supplies the energy for the DC/DC converter's operation during power failure. Interpoint recommends CLR-79 or CLR-81 wet slug tantalum capacitors because of their high CV properties and extended temperature operation. An alternative choice is a high quality grade aluminum electrolytic. To ensure maximum system stability, the capacitors should have a minimum ESR of 0.25 ohms, a minimum capacitance of 330 uF, and a maximum capacitance of 1 F.

The capacitance needed and derating required will depend on the system requirements, the load, and the efficiency of the converter being supplied power. The amount of capacitance for a given hold-up time is determined by the formula

$$C = \frac{2P\Delta t}{n(V_1^2 - V_2^2)} \quad \text{where:}$$

C is required capacitance (in Farads).
P is power to the load (output of converter) to be held up (in watts)
n is the efficiency of the converter at rated load (in %)
 Δt is hold-up time (in seconds)
V1 is charged capacitor voltage (in volts)
V2 is low-line voltage of DC/DC converter (in volts)

For a 50 msec hold-up of 30 W output from a converter with a efficiency of 80% and a 16 VDC low line and a 40 V capacitor charge:

$$C = \frac{(2) \cdot (30) \cdot (0.050)}{(0.80) \cdot (40^2 - 16^2)}, \quad C = \frac{3}{1075.2} = 2790 \mu\text{F}$$

Note: The output power delivered by the HUMMER module to deliver 30 W to the load with an 80% efficient converter is 37.5 watts. The HUM-40 is rated to deliver a maximum of 40 watts to the input of the converter. Interpoint data sheets for individual converters supply an efficiency curve vs. line and load for each converter model. In calculations, assume the efficiency rating for the nominal (usually 28 V) line condition.

Note: If the Capacitor Charged pin is connected to the converter's inhibit pin as shown in Figure 3, use 20 V as the low line figure in the formula.

DIODE SELECTION AND CONNECTION

An external diode is required for system operation as shown in Figure 3, with the diode anode connected to the HUMMER module's VCS pin and the DC/DC converter's +V in pin. This diode supplies input voltage to the converter when the internal voltage control switch (VCS) is open. The diode should be selected with a minimum current rating of 5 A and a voltage breakdown rating of 50 V or greater (similar to Motorola MDR1060 or equivalent).

CAUTION: Do not connect the HUMMER module's input return pin to the Cext return. This connection will short the module's current limit sense resistor resulting in excessive currents that can also damage the DC/DC converter.

INHIBIT FUNCTION

The HUMMER module's inhibit pin disables the internal boost converter when the Inhibit pin is pulled low. This is accomplished by an external connection to the Vin Return pin or Vout Return pin. The inhibit open circuit voltage is 10 V and the short circuit current is 15 mA. It is open-collector TTL or CMOS compatible. The pin is diode-isolated and can be reverse biased to include the input potential. Power Fail and Capacitor Charged flags are operable when the unit is inhibited.

FLAG FUNCTIONS

POWER FAIL FLAG

The Power Fail Flag output is implemented by a comparator monitoring the input voltage. (The comparator is also used to inhibit HUMMER module's operation; note however, that the flag is functional when the unit is inhibited.) The input voltage threshold is nominally 14.5 V to indicate that sufficient voltage is present for operation. The comparator output drives an internal MOSFET buffer which connects to the external Power Fail pin. The buffer is of an open drain configuration and requires an external pull-up resistor and voltage for indication. The maximum recommended pull-up voltage is 36 V. The maximum short circuit should not exceed 10mA. The buffer is protected by a shunt zener diode connected between the drain and the Cext Return. In normal operation, the input voltage exceeds the 14 V threshold and the output is high (open drain). When the input voltage is below 12 V the output is low, and the MOSFET conducts to the Return.

CAPACITOR CHARGED FLAG

A Capacitor Charged Flag is implemented by a comparator monitoring the HUMMER module's +Cext terminal. The capacitor voltage threshold is 36 V, at which point the external capacitor is charged to 80% of its maximum value. When the capacitor discharges, the flag resets at 20 VDC indicating that approximately 10% of the charge remains. The comparator output drives a MOSFET buffer amplifier, and the buffer output connects to the Cap Charged pin. The buffer is of an open drain configuration and requires a pull-up resistor and voltage for indication. The maximum recommended pull-up voltage is 36 V. The maximum short circuit current should not exceed 10 mA. During normal operation, the input is 40 V, exceeding the threshold, and the output is high (open circuit). When the capacitor voltage is below 20 V, the output is low, and the MOSFET conducts to the Return. The HUMMER module must be supplied with a minimum of 8 VDC for biasing internal circuits to obtain correct output states.

CASE F

CASES

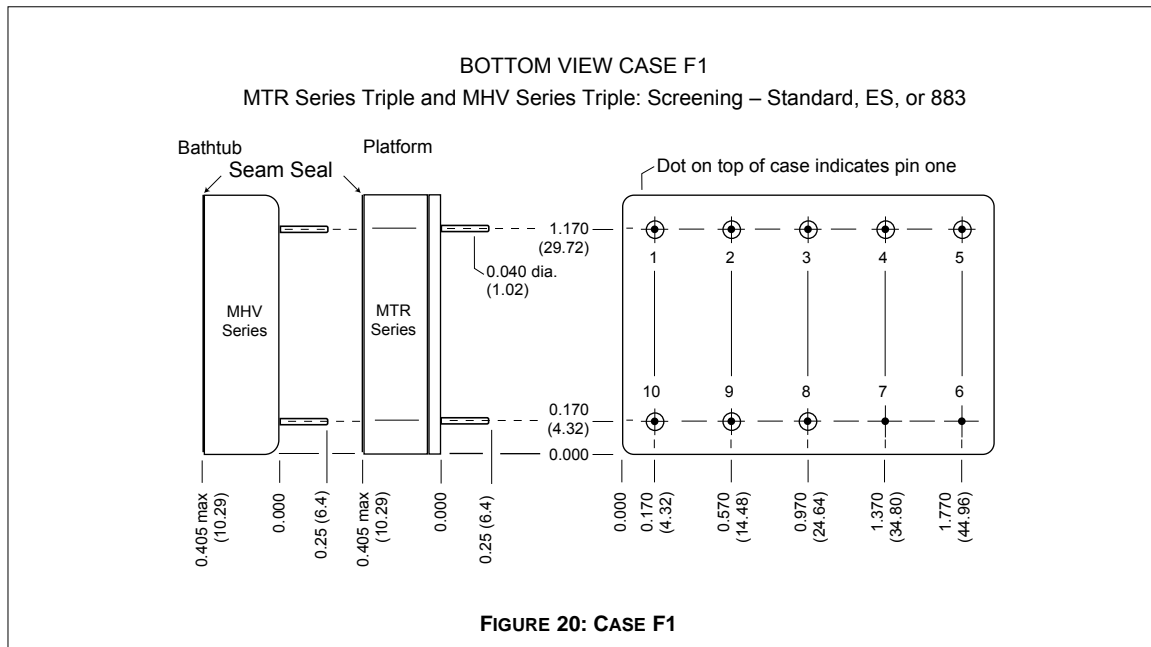
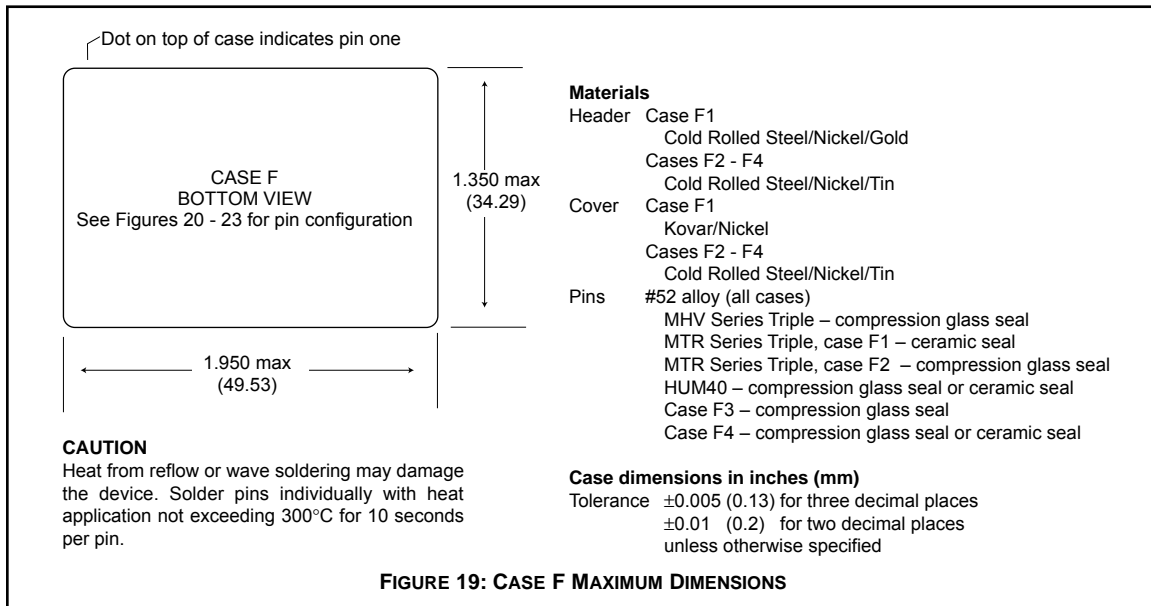

Note: Although every effort has been made to render the case drawings at actual size, variations in the printing process may cause some distortion. Please refer to the numerical dimensions for accuracy.

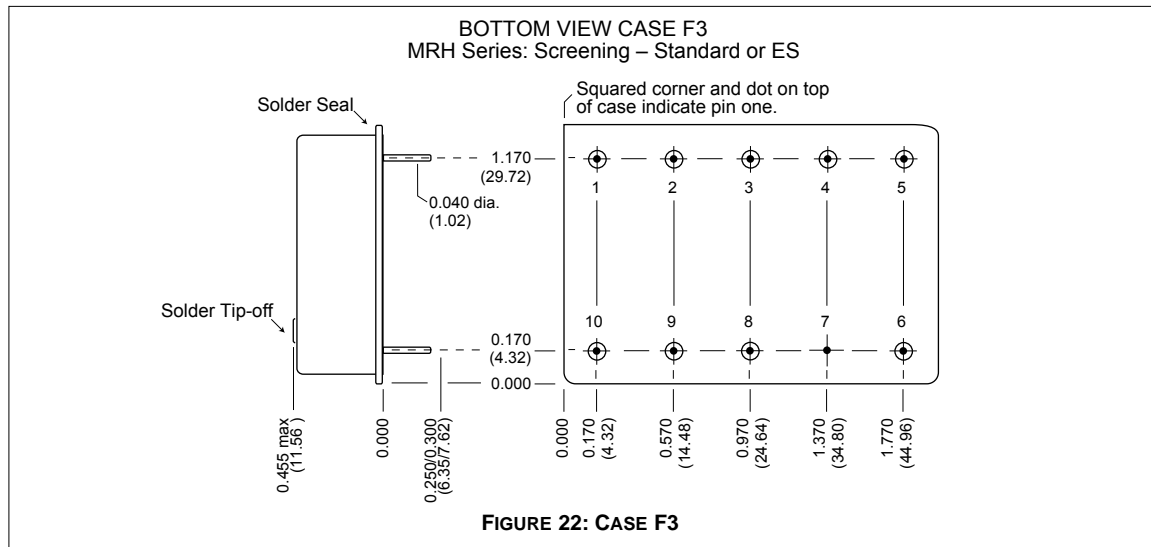
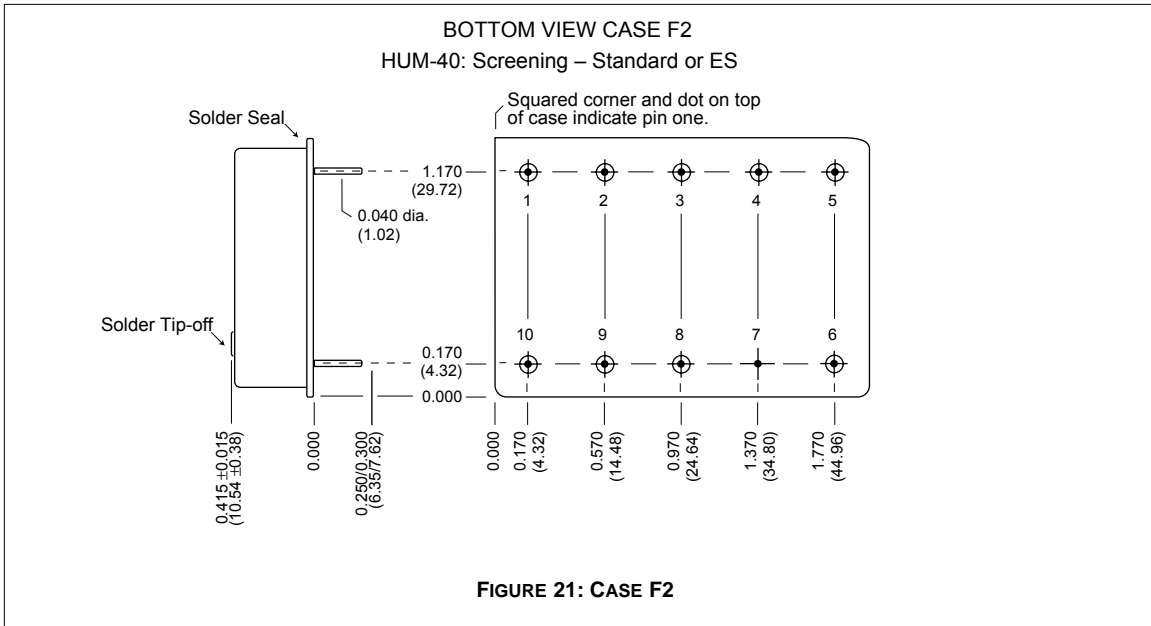

CASE J

CASES

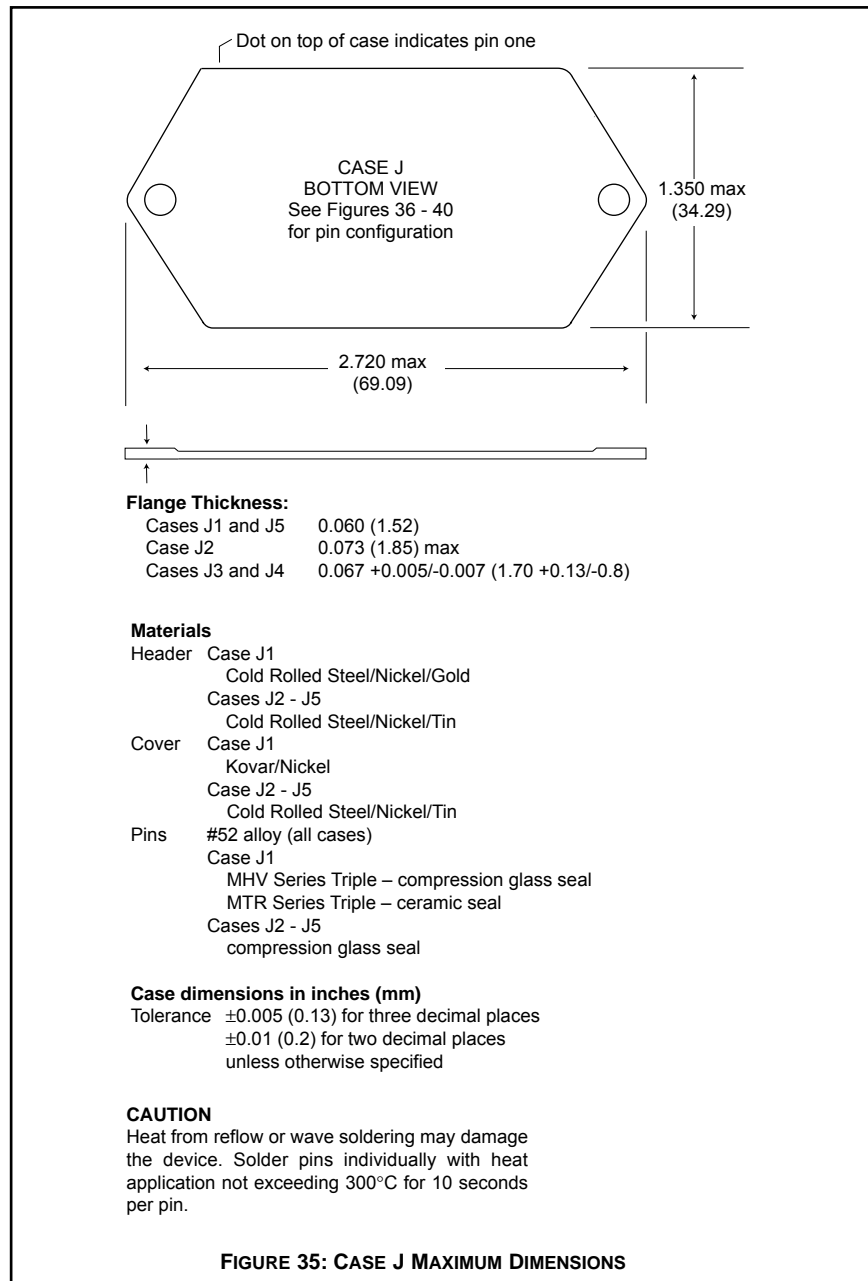

Note: Although every effort has been made to render the case drawings at actual size, variations in the printing process may cause some distortion. Please refer to the numerical dimensions for accuracy.

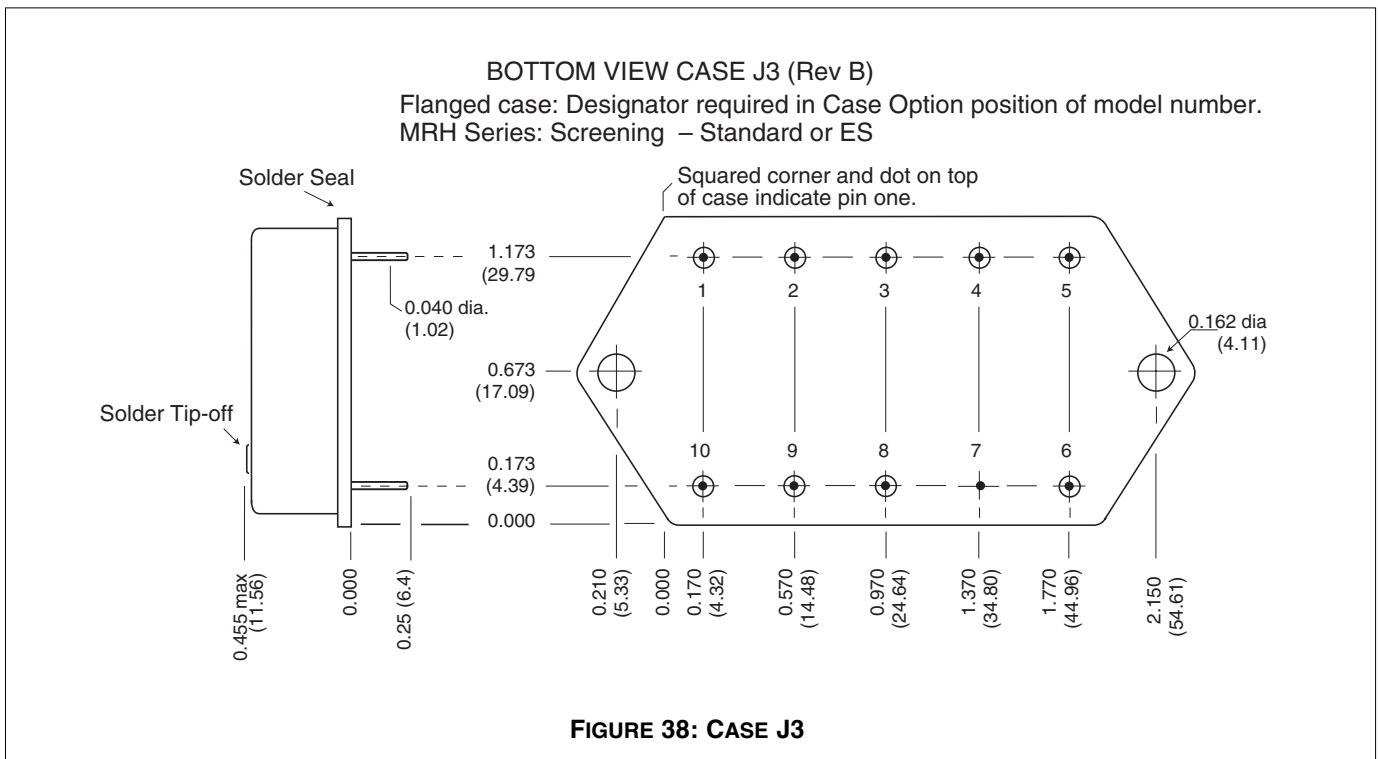
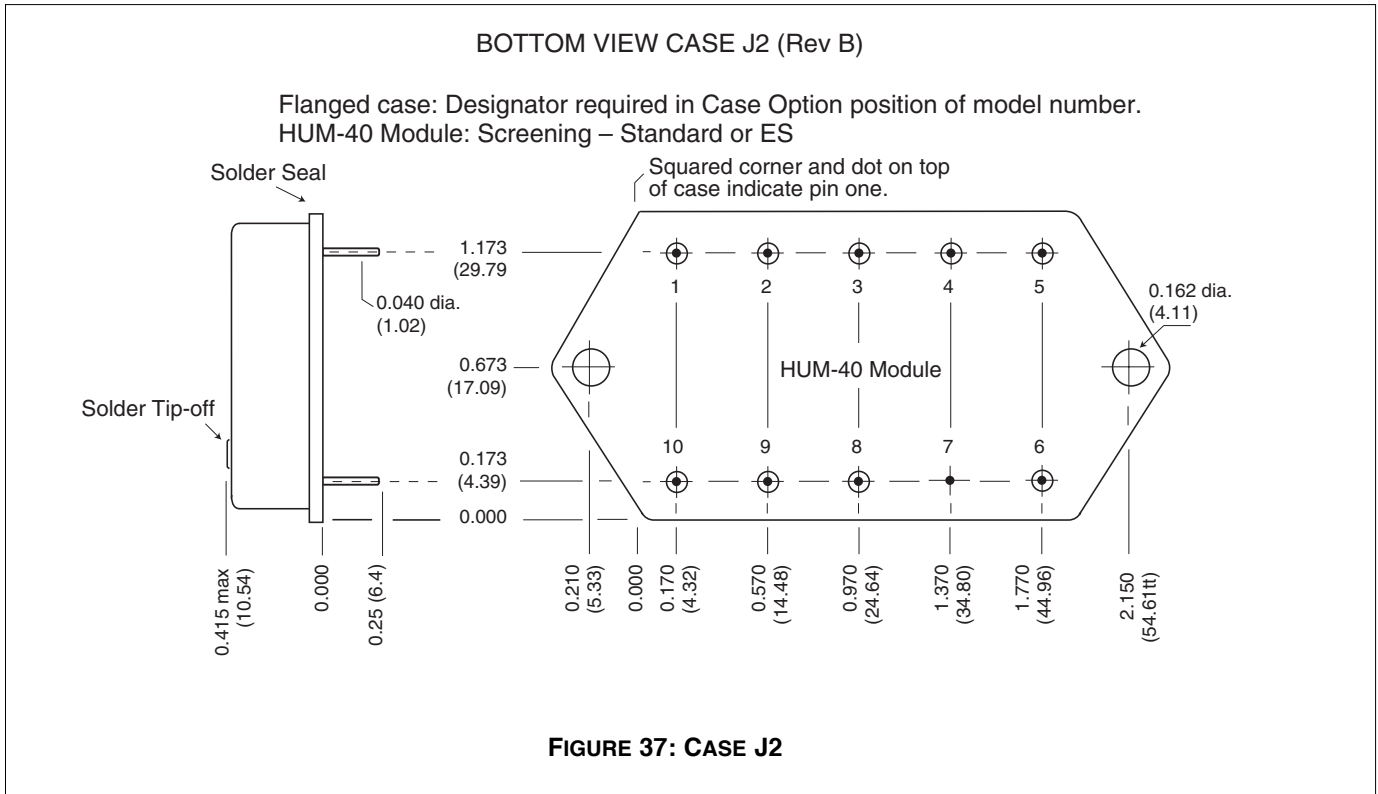

CASE U

CASES

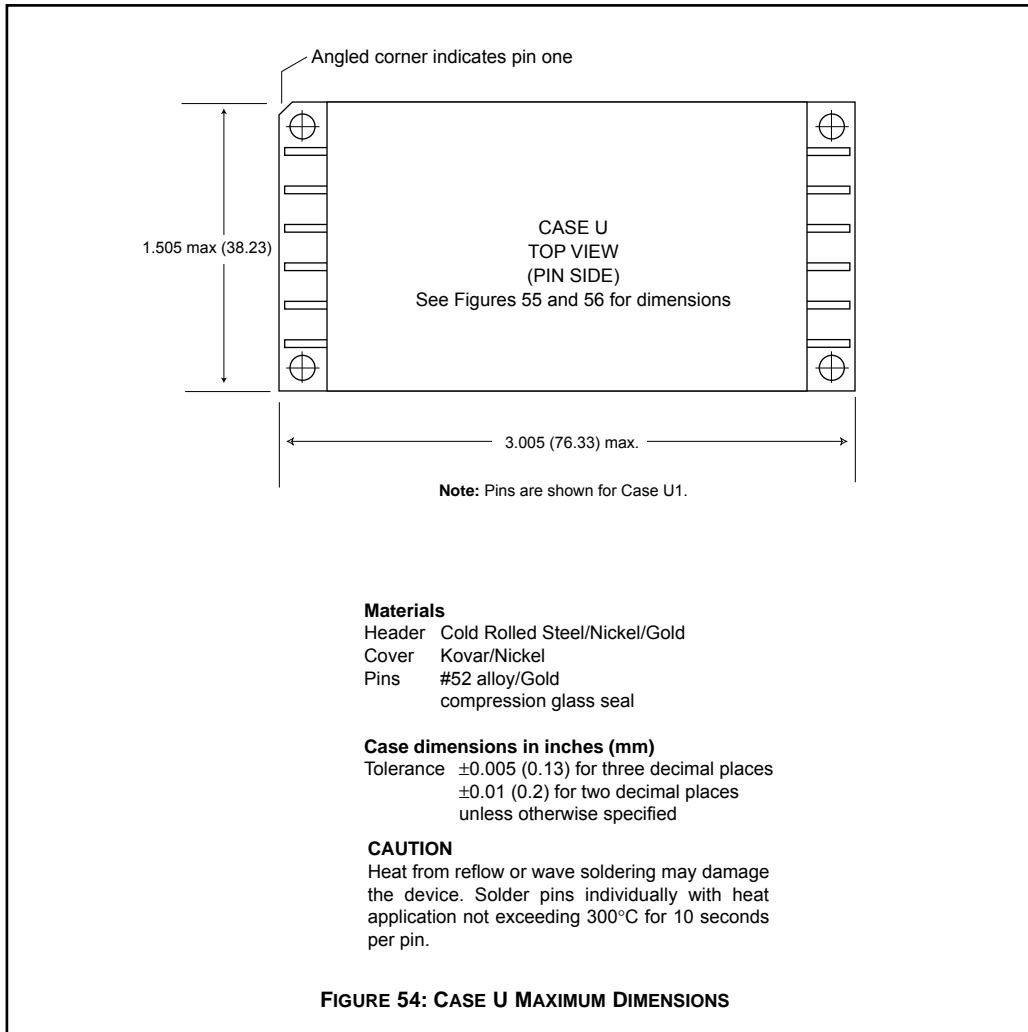

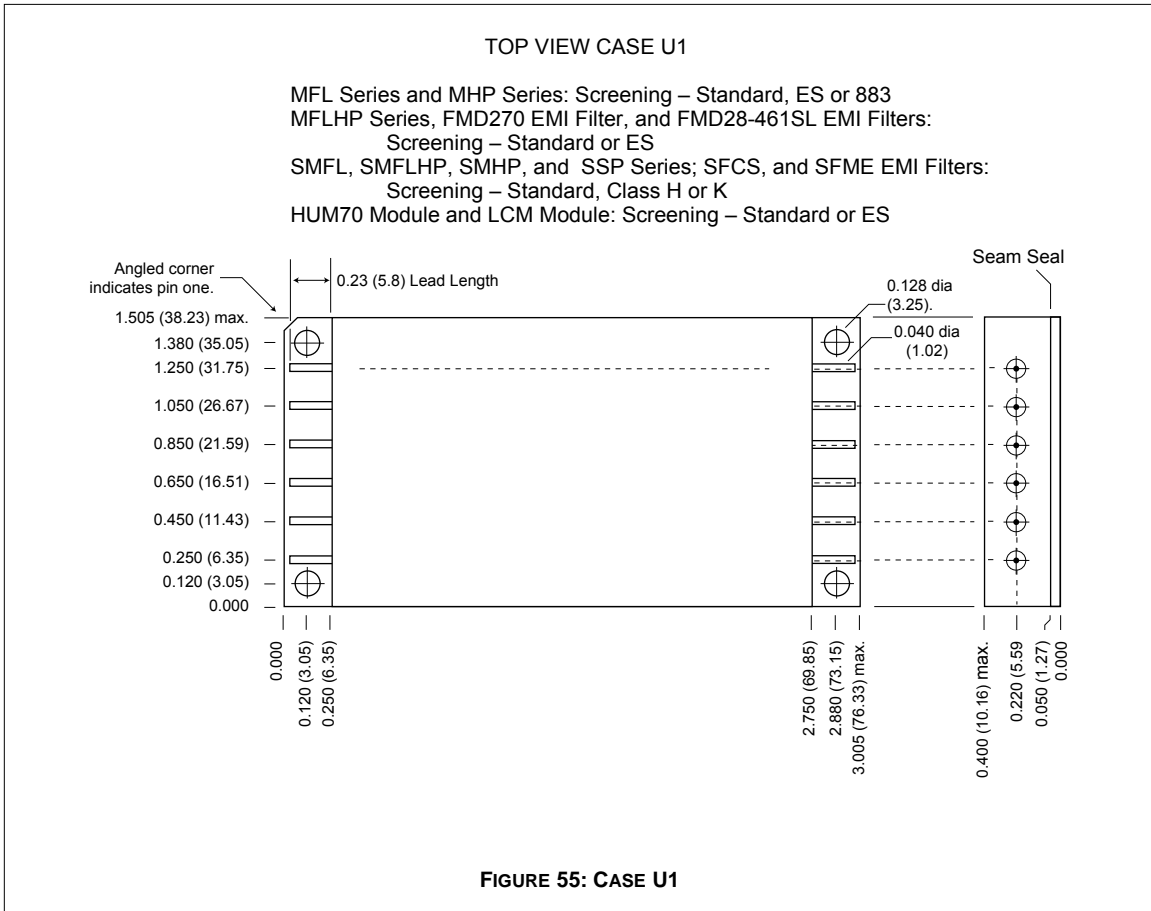

**QA SCREENING
125°C PRODUCTS**

125°C PRODUCTS

TEST (125°C Products)	STANDARD	/ES	/883 (Class H)*
PRE-CAP INSPECTION Method 2017, 2032	yes	yes	yes
TEMPERATURE CYCLE (10 times) Method 1010, Cond. C, -65°C to 150°C Method 1010, Cond. B, -55°C to 125°C	no no	no yes	yes no
CONSTANT ACCELERATION Method 2001, 3000 g Method 2001, 500 g	no no	no yes	yes no
BURN-IN Method 1015, 160 hours at 125°C 96 hours at 125°C case (typical)	no no	no yes	yes no
FINAL ELECTRICAL TEST MIL-PRF-38534, Group A Subgroups 1 through 6: -55°C, +25°C, +125°C Subgroups 1 and 4: +25°C case	no yes	no yes	yes no
HERMETICITY TESTING Fine Leak, Method 1014, Cond. A Gross Leak, Method 1014, Cond. C Gross Leak, Dip (1 x 10 ⁻³)	no no yes	yes yes no	yes yes no
FINAL VISUAL INSPECTION Method 2009	yes	yes	yes

Test methods are referenced to MIL-STD-883 as determined by MIL-PRF-38534.

*883 products are built with element evaluated components and are 100% tested and guaranteed over the full military temperature range of -55°C to +125°C.

Applies to the following products (some models do not offer “883” screening, please refer to the individual series datasheets to determine what screening is available):

MOR Series	MHD Series	MGH Series	FMGA EMI Filter
MFLHP Series	MHV Series	MCH Series	FMSA EMI Filter
MFL Series	MHF+ Series	FM-704A EMI Filter	HUM Modules
MHP Series	MHF Series	FMD/FME EMI Filter	LCM Modules
MTR Series	MGA Series	FMC EMI Filter	LIM Modules
MQO Series	MSA Series	FMH EMI Filter	