

PART No.	A (Depth)	B (Depth)	C (Depth)
	Overall	Useable	Top/Btm U Usable
HWMR1920U	18.0" - 24.0"	15.1" - 21.1"	12.4" - 18.4"

NOTE: DEPTH IS FULLY ADJUSTABLE WITHIN RANGE.

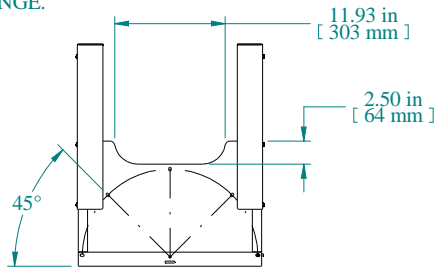

TOP VIEW

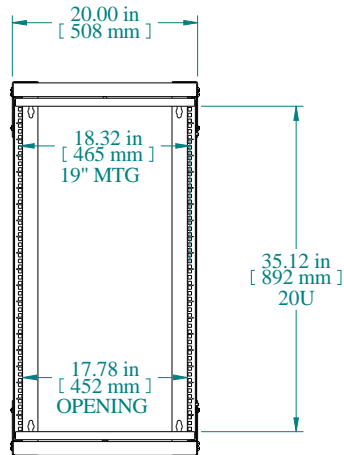

FRONT VIEW

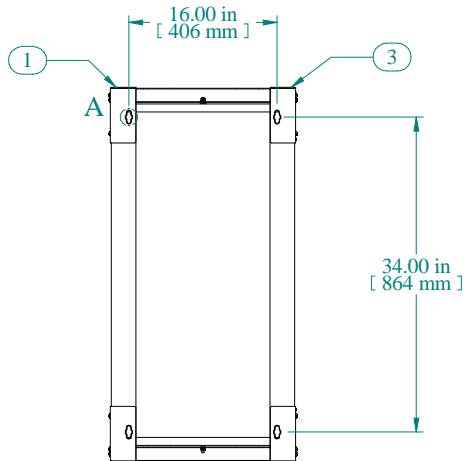

REAR VIEW
WALL MOUNT DIMENSIONS

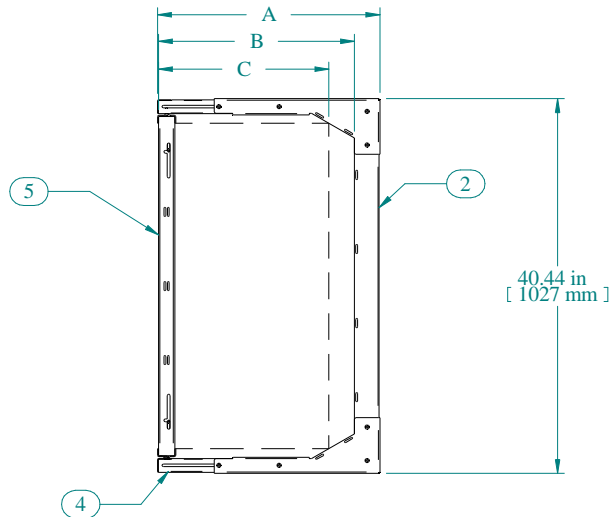

SIDE VIEW

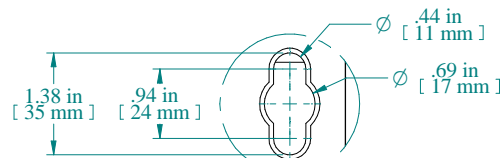

DETAIL A
MOUNTING HOLES
TYP 4 PLCS

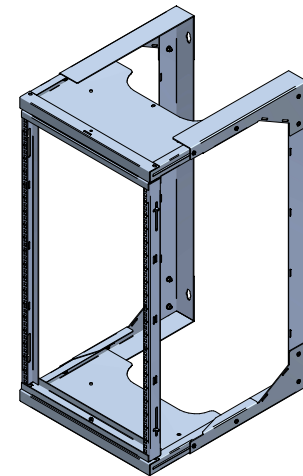

Item Number	Title	Quantity
1	HWMR - MAIN SUPPORT BRKT RH	2
2	HWMR - VERT WALL BRKT	2
3	HWMR - MAIN SUPPORT BRKT LH	2
4	HWMR - TOP/BTM SUPPORT	2
5	HWMR - SWING FRAME ASSY	1

PART NUMBERS

HWMR1920U | PAINTED BLACK THIN FILM

NOTES

Adjustable depth and rotating rack
Shipped knockdown, includes assembly hardware
NO MOUNTING HARDWARE INCLUDED
See Hammond Website for Additional Accessories

Data subject to change without notice. Isometric drawing not to scale.

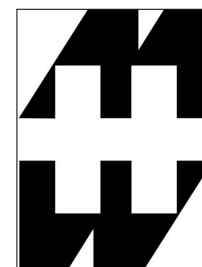

**HAMMOND
MANUFACTURING™**

www.hammondmfg.com

PART NO. HWMR1920U