

M62333P/FP, M62338P/FP

R03DS0038EJ0500

8-bit 3ch I²C BUS D/A Converter with Buffer Amplifiers

Rev.5.00

Jun 03, 2011

Description

The M62333/M62338 is an integrated circuit semiconductor of CMOS structure with 3 channels of built in D/A converters with output buffer operational amplifiers.

The input is 2-wires serial method is used for the transfer format of digital data to allow connection with a microcomputer with minimum wiring.

The output buffer operational amplifier employs AB class output circuit with sync and source drive capacity of 1.0 mA or more, and it operates in the whole voltage range from V_{CC} to ground.

The M62333 and the M62338 differ only in their slave address.

Features

- Digital data transfer format: I²C BUS serial data method
- Output buffer operational amplifier: It operates in the whole voltage range from V_{CC} to ground.
- High output current drive capacity: ±1.0 mA over

Application

Conversion from digital data to analog control data for home-use and industrial equipment.

Signal gain control or automatic adjustment of Display-monitor or CTV.

Block Diagram

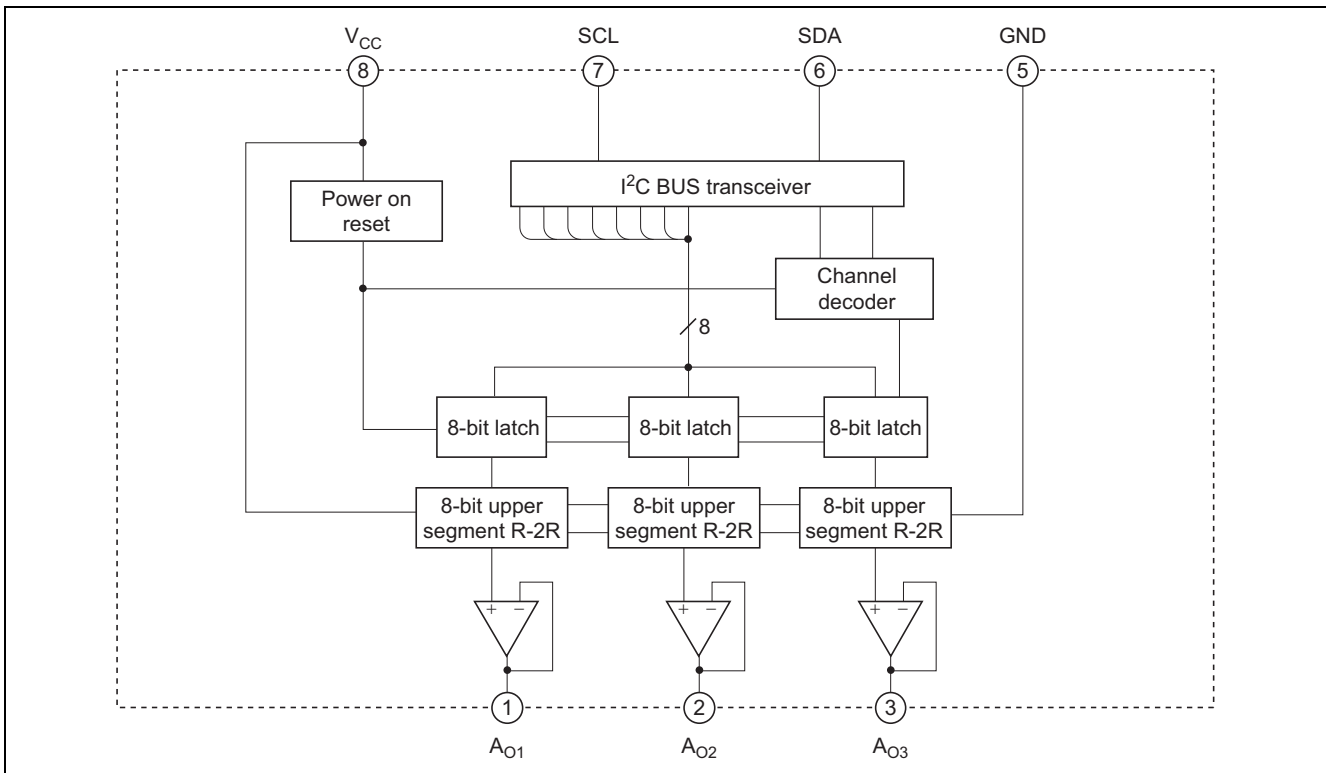

Pin Arrangement

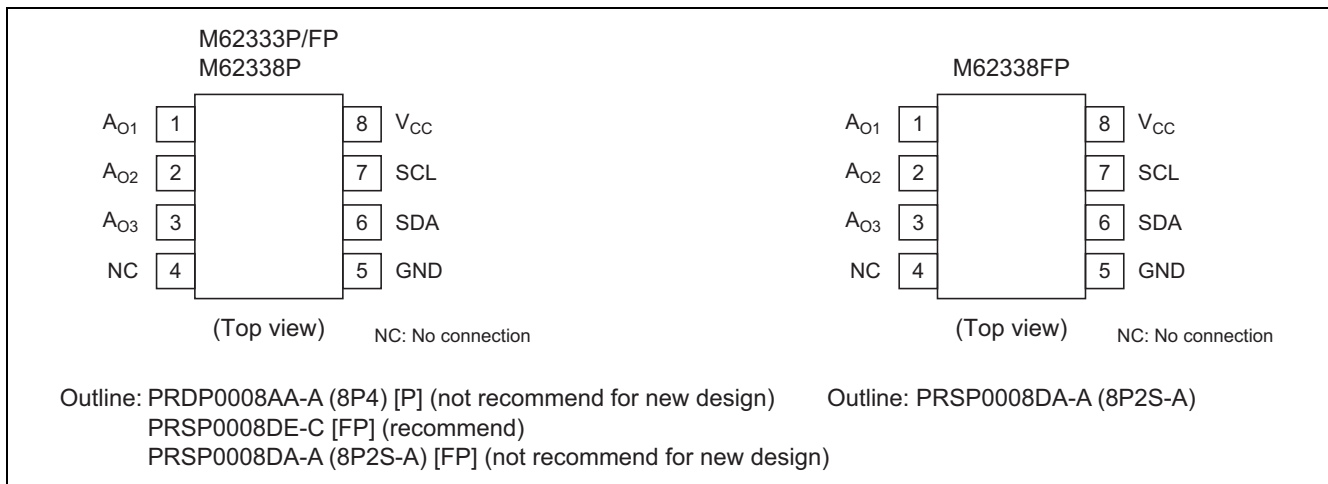

Pin Description

Pin No.	Pin Name	Function
6	SDA	Serial data input terminal
7	SCL	Serial clock input terminal
1	A ₀₁	8-bit resolution D/A converter output terminal
2	A ₀₂	
3	A ₀₃	
8	V _{CC}	Power supply terminal
5	GND	GND terminal

Absolute Maximum Ratings

Item	Symbol	Ratings	Unit
Supply voltage	V_{CC}	-0.3 to 7.0	V
Input voltage	V_{in}	-0.3 to $V_{CC} + 0.3$	V
Output voltage	V_O	-0.3 to $V_{CC} + 0.3$	V
Power dissipation	P_d	417 (P) / 272 (FP)	mW
Operating temperature	T_{opr}	-20 to 85	°C
Storage temperature	T_{stg}	-40 to 125	°C

Electrical Characteristics

($V_{CC} = +5\text{ V} \pm 10\%$, $GND = 0\text{ V}$, $T_a = -20\text{ to }85^\circ\text{C}$ unless otherwise noted)

Item	Symbol	Limits			Unit	Test Conditions
		Min	Typ	Max		
Supply voltage	V_{CC}	2.7	5.0	5.5	V	
Supply current	I_{CC}	0	0.9	2.7	mA	CLK = 500 kHz operation, $I_{AO} = 0\ \mu\text{A}$ Data: 6Ah (at maximum current)
		0	0.6	1.8	mA	SDA = SCL = GND, $I_{AO} = 0\ \mu\text{A}$
Output low voltage (SDA)	V_{OL}	—	—	0.4	V	$I_{sink} = 3\text{ mA}$
Input leak current	I_{ILK}	-10	—	10	μA	$V_{IN} = 0\text{ to }V_{CC}$
Input low voltage	V_{IL}	—	—	$0.2 V_{CC}$	V	
Input high voltage	V_{IH}	$0.8 V_{CC}$	—	—	V	
Buffer amplifier output voltage range	V_{AO}	0.1	—	$V_{CC} - 0.1$	V	$I_{AO} = \pm 100\ \mu\text{A}$
		0.2	—	$V_{CC} - 0.2$	V	$I_{AO} = \pm 500\ \mu\text{A}$
Buffer amplifier output drive range	I_{AO}	-1.0	—	1.0	mA	Upper side saturation voltage = 0.3 V Lower side saturation voltage = 0.2 V
Differential nonlinearity	S_{DL}	-1.0	—	1.0	LSB	$V_{CC} = 5.12\text{ V}$ (20 mV/LSB) without load ($I_{AO} = 0$)
Nonlinearity	S_L	-1.5	—	1.5	LSB	
Zero code error	S_{ZERO}	-2.0	—	2.0	LSB	
Full scale error	S_{FULL}	-2.0	—	2.0	LSB	
Output capacitance load	C_O	—	—	0.1	μF	
Buffer amplifier output impedance	R_O	—	5.0	—	Ω	

I²C BUS Line Characteristics

Item	Symbol	Min	Max	Unit
SCL clock frequency	t_{SCL}	0	100	kHz
Time the bus must be free before a new transmission can start	t_{BUF}	4.7	—	μ s
Hold time START condition (After this period, the first clock pulse is generated)	$t_{HD:STA}$	4.0	—	μ s
Low period of the clock	t_{LOW}	4.7	—	μ s
High period of the clock	t_{HIGH}	4.0	—	μ s
Set-up time for START condition (Only relevant for a repeated START condition)	$t_{SU:STA}$	4.7	—	μ s
Hold time DATA	$t_{HD:DAT}$	0	—	μ s
Set-up time DATA	$t_{SU:DAT}$	250	—	ns
Rise time of both SDA and SCL lines	t_R	—	1000	ns
Fall time of both SDA and SCL lines	t_F	—	300	ns
Set-up time for STOP condition	$t_{SU:STO}$	4.0	—	μ s

Note: Transmitter must internally provide at least a hold time to bridge the undefined region (300 ns Max) of the falling edge of SCL.

Timing Chart

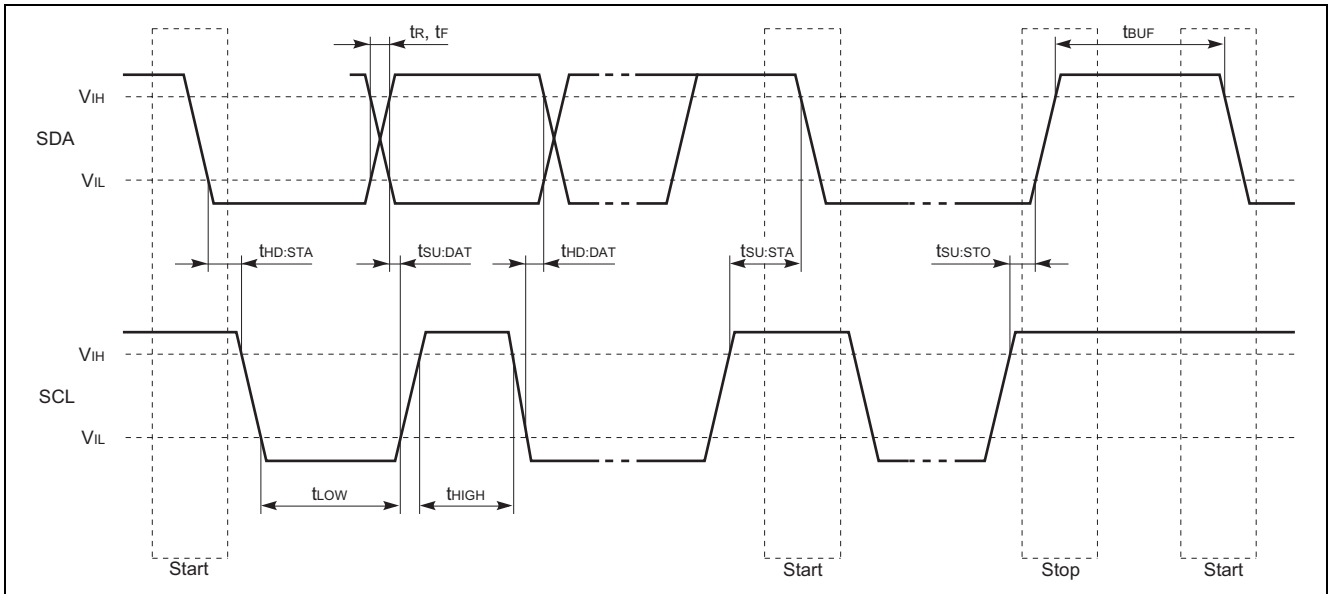

I²C BUS Format

STA	Slave address	W	A	Sub address	A	DAC data	A	STP
-----	---------------	---	---	-------------	---	----------	---	-----

Note: STA: start condition, A: affirmation bit, W: write (SDA = Low), STP: stop condition

- Slave address

M62333

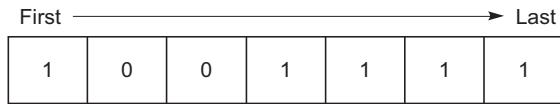

M62338

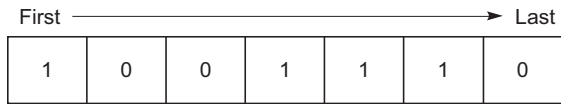

- Sub address

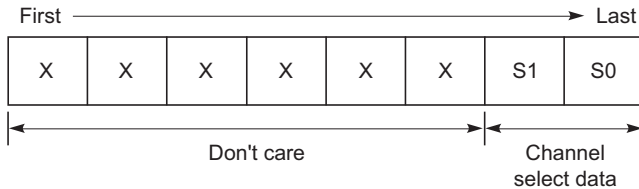

Channel select data

S1	S0	Channel Selection
0	0	ch1 selection
0	1	ch2 selection
1	0	ch3 selection
1	1	Don't care

- DAC data

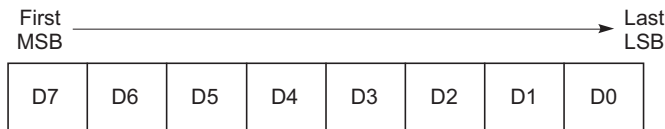

D7	D6	D5	D4	D3	D2	D1	D0	DAC output
0	0	0	0	0	0	0	0	$V_{CC} / 256 \times 1$
0	0	0	0	0	0	0	1	$V_{CC} / 256 \times 2$
0	0	0	0	0	0	1	0	$V_{CC} / 256 \times 3$
0	0	0	0	0	0	1	1	$V_{CC} / 256 \times 4$
:	:	:	:	:	:	:	:	:
1	1	1	1	1	1	1	0	$V_{CC} / 256 \times 255$
1	1	1	1	1	1	1	1	V_{CC}

Timing Chart (Model)

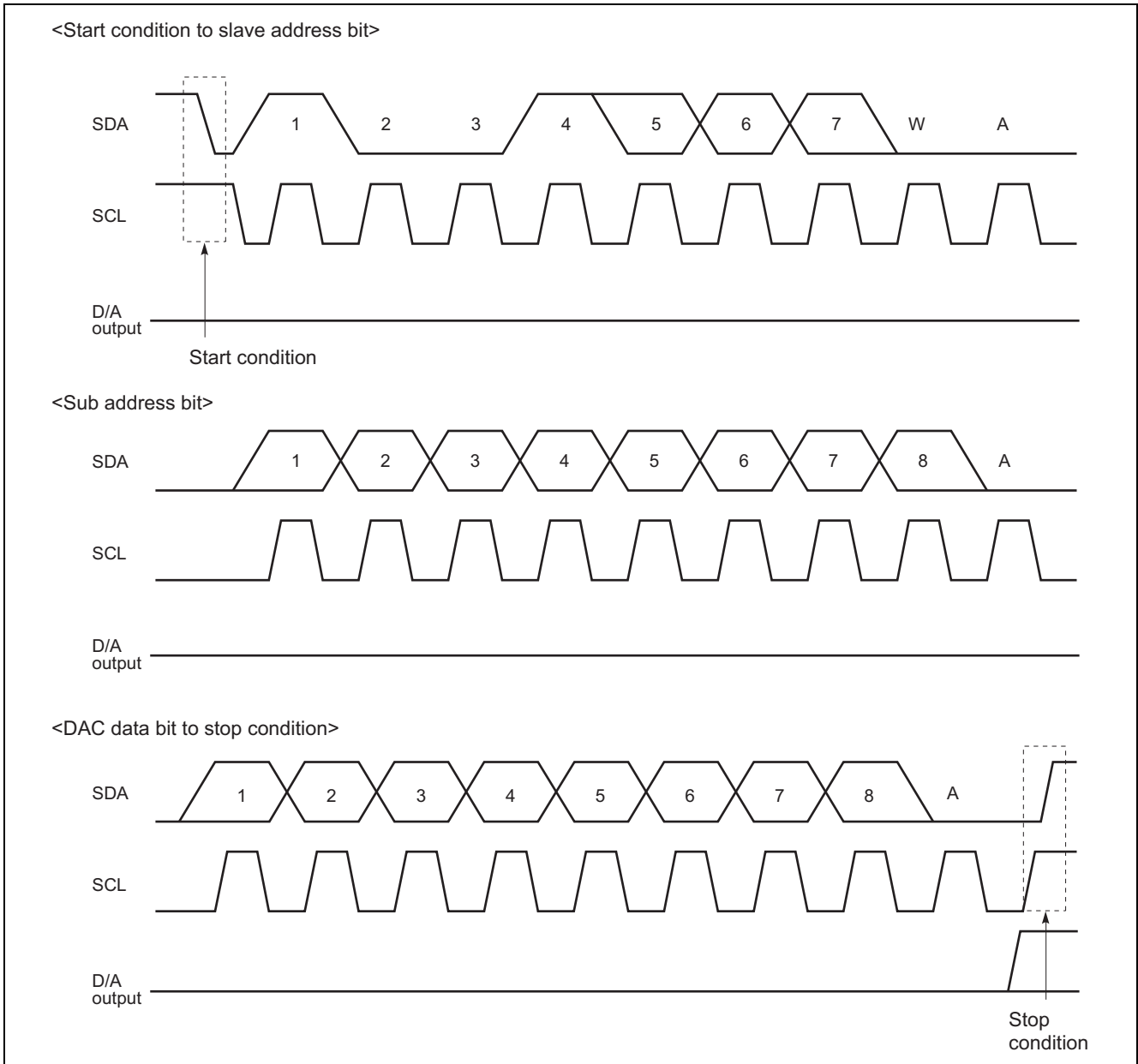

- Start condition With SCL at High, SDA line goes from High to Low
- Stop condition With SCL at High, SDA line goes from Low to High
(Under normal circumstances, SDA is changed when SCL is Low)
- Acknowledge bit The receiving IC has to pull down SDA line whenever receive slave data.
(The transmitting IC releases the SDA line just then transmit 8-bit data.)

Digital Data Formats

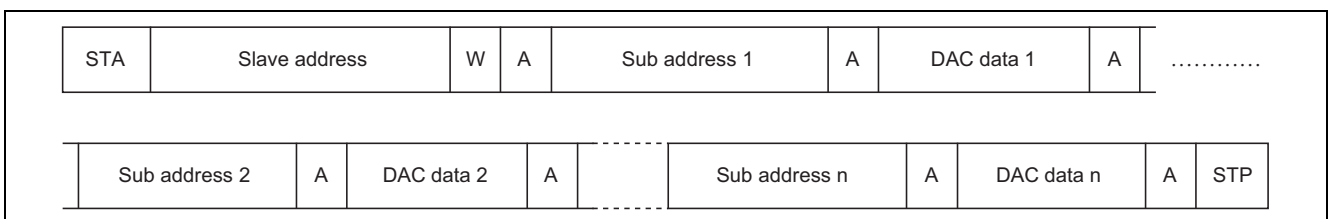

Precaution for Use

- Supply voltage terminal (V_{CC}) is also used for D/A converter upper reference voltage setting. If ripple or spike is input this terminal, accuracy of D/A conversion is down. So, when use this device, please connect capacitor among V_{CC} to GND for stable D/A conversion.
- This IC's output amplifier has an advantage to capacitive load. So it's no problem at device action when connect capacitor (0.1 μF Max) among output to GND for every noise eliminate.
- Purchase of Renesas's I²C components conveys a license under the Philips I²C Patent Rights to use these components an I²C system, provided that the system conforms to I²C Standard Specification as defined by Philips.

Application Example

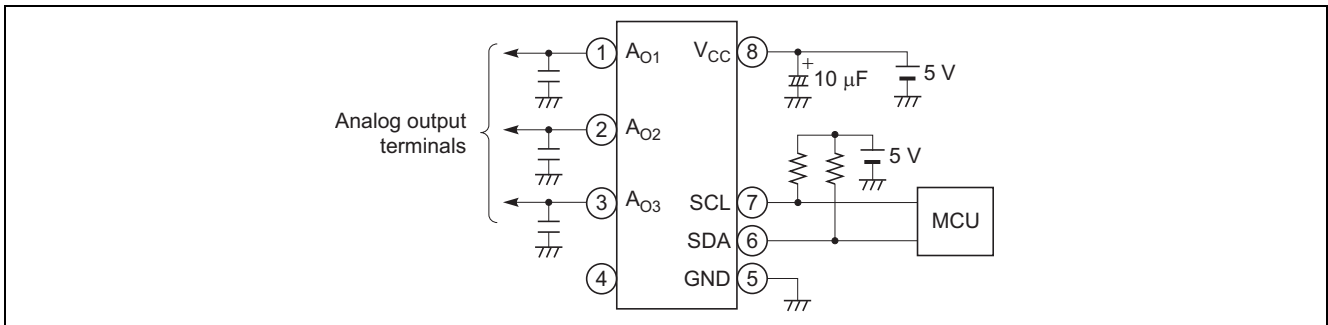

Package Dimensions

JEITA Package Code	RENEASAS Code	Previous Code	MASS[Typ.]
P-DIP8-6.3x8.84-2.54	PRDP0008AA-A	8P4	0.5g

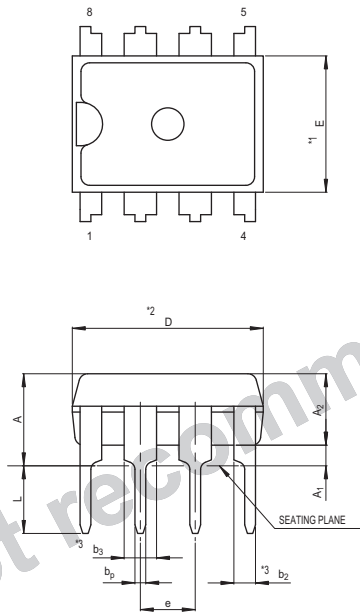

NOTE)
 1. DIMENSIONS **1* AND **2* DO NOT INCLUDE MOLD FLASH.
 2. DIMENSION **3* DOES NOT INCLUDE TRIM OFFSET.

Reference Symbol	Dimension in Millimeters		
	Min	Nom	Max
e1	7.32	7.62	7.92
D	8.7	8.9	9.1
E	6.15	6.3	6.45
A	—	—	4.5
A1	0.51	—	—
A2	—	3.3	—
bp	0.4	0.5	0.6
b2	0.9	1.0	1.3
b3	1.4	1.5	1.8
c	0.22	0.27	0.34
θ	0°	—	15°
e	2.29	2.54	2.79
L	3.0	—	—

JEITA Package Code	RENEASAS Code	Previous Code	MASS[Typ.]
P-SOP8-4.4x4.85-1.27	PRSP0008DE-C	—	0.1g

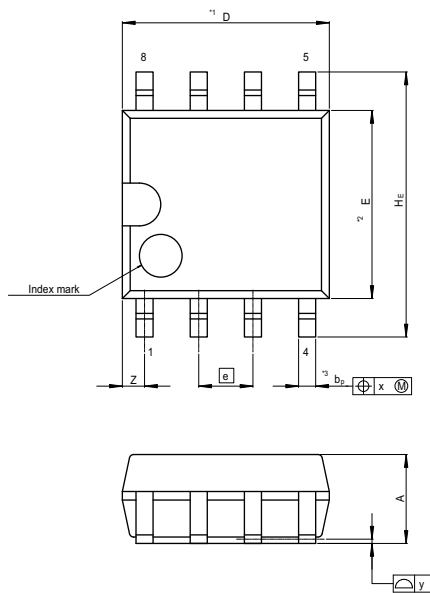

NOTE)
 1. DIMENSIONS **1* (Nom)* AND **2* DO NOT INCLUDE MOLD FLASH.
 2. DIMENSION **3* DOES NOT INCLUDE TRIM OFFSET.

Reference Symbol	Dimension in Millimeters		
	Min	Nom	Max
D	4.65	4.85	5.05
E	4.2	4.4	4.6
A2	—	1.85	—
A1	0.00	0.1	0.20
A	—	—	2.03
bp	0.34	0.4	0.46
b1	—	—	—
c	0.15	0.20	0.25
c1	—	—	—
θ	0°	—	8°
HE	5.7	6.2	6.5
a	1.12	1.27	1.42
x	—	—	0.12
y	—	—	0.10
Z	—	—	0.75
L	0.25	0.45	0.65
L1	—	0.90	—

M62333P/FP, M62338P/FP

JEITA Package Code	RENESAS Code	Previous Code	MASS[Typ.]
P-SOP8-4.4x5-1.27	PRSP0008DA-A	8P2S-A	0.07g

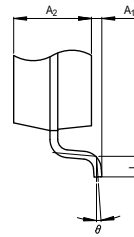
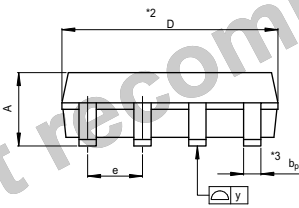
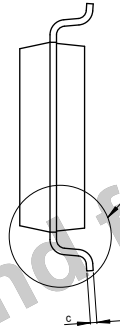
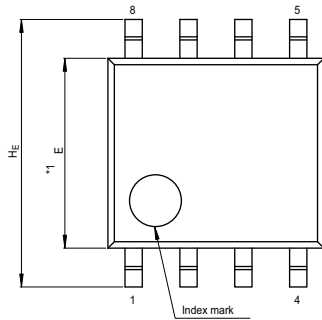

NOTE)
 1. DIMENSIONS **1* AND **2* DO NOT INCLUDE MOLD FLASH.
 2. DIMENSION **3* DOES NOT INCLUDE TRIM OFFSET.

Reference Symbol	Dimension in Millimeters		
	Min	Nom	Max
D	4.8	5.0	5.2
E	4.2	4.4	4.6
A ₂	—	1.5	—
A ₁	0.05	—	—
A	—	—	1.9
b _p	0.35	0.4	0.5
c	0.13	0.15	0.2
θ	0°	—	10°
H _E	5.9	6.2	6.5
e	1.12	1.27	1.42
y	—	—	0.1
L	0.2	0.4	0.6

Notice

- All information included in this document is current as of the date this document is issued. Such information, however, is subject to change without any prior notice. Before purchasing or using any Renesas Electronics products listed herein, please confirm the latest product information with a Renesas Electronics sales office. Also, please pay regular and careful attention to additional and different information to be disclosed by Renesas Electronics such as that disclosed through our website.
- Renesas Electronics does not assume any liability for infringement of patents, copyrights, or other intellectual property rights of third parties by or arising from the use of Renesas Electronics products or technical information described in this document. No license, express, implied or otherwise, is granted hereby under any patents, copyrights or other intellectual property rights of Renesas Electronics or others.
- You should not alter, modify, copy, or otherwise misappropriate any Renesas Electronics product, whether in whole or in part.
- Descriptions of circuits, software and other related information in this document are provided only to illustrate the operation of semiconductor products and application examples. You are fully responsible for the incorporation of these circuits, software, and information in the design of your equipment. Renesas Electronics assumes no responsibility for any losses incurred by you or third parties arising from the use of these circuits, software, or information.
- When exporting the products or technology described in this document, you should comply with the applicable export control laws and regulations and follow the procedures required by such laws and regulations. You should not use Renesas Electronics products or the technology described in this document for any purpose relating to military applications or use by the military, including but not limited to the development of weapons of mass destruction. Renesas Electronics products and technology may not be used for or incorporated into any products or systems whose manufacture, use, or sale is prohibited under any applicable domestic or foreign laws or regulations.
- Renesas Electronics has used reasonable care in preparing the information included in this document, but Renesas Electronics does not warrant that such information is error free. Renesas Electronics assumes no liability whatsoever for any damages incurred by you resulting from errors in or omissions from the information included herein.
- Renesas Electronics products are classified according to the following three quality grades: "Standard", "High Quality", and "Specific". The recommended applications for each Renesas Electronics product depends on the product's quality grade, as indicated below. You must check the quality grade of each Renesas Electronics product before using it in a particular application. You may not use any Renesas Electronics product for any application categorized as "Specific" without the prior written consent of Renesas Electronics. Further, you may not use any Renesas Electronics product for any application for which it is not intended without the prior written consent of Renesas Electronics. Renesas Electronics shall not be in any way liable for any damages or losses incurred by you or third parties arising from the use of any Renesas Electronics product for an application categorized as "Specific" or for which the product is not intended where you have failed to obtain the prior written consent of Renesas Electronics. The quality grade of each Renesas Electronics product is "Standard" unless otherwise expressly specified in a Renesas Electronics data sheets or data books, etc.
"Standard": Computers; office equipment; communications equipment; test and measurement equipment; audio and visual equipment; home electronic appliances; machine tools; personal electronic equipment; and industrial robots.
"High Quality": Transportation equipment (automobiles, trains, ships, etc.); traffic control systems; anti-disaster systems; anti-crime systems; safety equipment; and medical equipment not specifically designed for life support.
"Specific": Aircraft; aerospace equipment; submersible repeaters; nuclear reactor control systems; medical equipment or systems for life support (e.g. artificial life support devices or systems), surgical implantations, or healthcare intervention (e.g. excision, etc.), and any other applications or purposes that pose a direct threat to human life.
- You should use the Renesas Electronics products described in this document within the range specified by Renesas Electronics, especially with respect to the maximum rating, operating supply voltage range, movement power voltage range, heat radiation characteristics, installation and other product characteristics. Renesas Electronics shall have no liability for malfunctions or damages arising out of the use of Renesas Electronics products beyond such specified ranges.
- Although Renesas Electronics endeavors to improve the quality and reliability of its products, semiconductor products have specific characteristics such as the occurrence of failure at a certain rate and malfunctions under certain use conditions. Further, Renesas Electronics products are not subject to radiation resistance design. Please be sure to implement safety measures to guard them against the possibility of physical injury, and injury or damage caused by fire in the event of the failure of a Renesas Electronics product, such as safety design for hardware and software including but not limited to redundancy, fire control and malfunction prevention, appropriate treatment for aging degradation or any other appropriate measures. Because the evaluation of microcomputer software alone is very difficult, please evaluate the safety of the final products or system manufactured by you.
- Please contact a Renesas Electronics sales office for details as to environmental matters such as the environmental compatibility of each Renesas Electronics product. Please use Renesas Electronics products in compliance with all applicable laws and regulations that regulate the inclusion or use of controlled substances, including without limitation, the EU RoHS Directive. Renesas Electronics assumes no liability for damages or losses occurring as a result of your noncompliance with applicable laws and regulations.
- This document may not be reproduced or duplicated, in any form, in whole or in part, without prior written consent of Renesas Electronics.
- Please contact a Renesas Electronics sales office if you have any questions regarding the information contained in this document or Renesas Electronics products, or if you have any other inquiries.
(Note 1) "Renesas Electronics" as used in this document means Renesas Electronics Corporation and also includes its majority-owned subsidiaries.
(Note 2) "Renesas Electronics product(s)" means any product developed or manufactured by or for Renesas Electronics.



SALES OFFICES

Renesas Electronics Corporation

<http://www.renesas.com>

Refer to "<http://www.renesas.com/>" for the latest and detailed information.

Renesas Electronics America Inc.
2880 Scott Boulevard Santa Clara, CA 95050-2554, U.S.A.
Tel: +1-408-586-6000, Fax: +1-408-586-6130

Renesas Electronics Canada Limited
1101 Nicholson Road, Newmarket, Ontario L3Y 9C3, Canada
Tel: +1-905-898-5441, Fax: +1-905-898-3220

Renesas Electronics Europe Limited
Dukes Meadow, Millboard Road, Bourne End, Buckinghamshire, SL8 5FH, U.K.
Tel: +44-1628-585-100, Fax: +44-1628-585-900

Renesas Electronics Europe GmbH
Arcadiastrasse 10, 40472 Düsseldorf, Germany
Tel: +49-211-65030, Fax: +49-211-6503-1327

Renesas Electronics (China) Co., Ltd.
7th Floor, Quantum Plaza, No.27 ZhiChunLu Haidian District, Beijing 100083, P.R.China
Tel: +86-10-8235-1155, Fax: +86-10-8235-7679

Renesas Electronics (Shanghai) Co., Ltd.
Unit 204, 205, AZIA Center, No.1233 Lujiazui Ring Rd., Pudong District, Shanghai 200120, China
Tel: +86-21-5877-1818, Fax: +86-21-6887-7858 / -7898

Renesas Electronics Hong Kong Limited
Unit 1601-1613, 16/F., Tower 2, Grand Century Place, 193 Prince Edward Road West, Mongkok, Kowloon, Hong Kong
Tel: +852-2886-9318, Fax: +852 2886-9022/9044

Renesas Electronics Taiwan Co., Ltd.
13F, No. 363, Fu Shing North Road, Taipei, Taiwan
Tel: +886-2-8175-9600, Fax: +886 2-8175-9670

Renesas Electronics Singapore Pte. Ltd.
1 HarbourFront Avenue, #06-10, Keppel Bay Tower, Singapore 098632
Tel: +65-6213-0200, Fax: +65-6276-8001

Renesas Electronics Malaysia Sdn.Bhd.
Unit 906, Block B, Menara Amcorp, Amcorp Trade Centre, No. 18, Jin Persiaran Barat, 46050 Petaling Jaya, Selangor Darul Ehsan, Malaysia
Tel: +60-3-7955-9390, Fax: +60-3-7955-9510

Renesas Electronics Korea Co., Ltd.
11F., Samik Lavied' or Bldg., 720-2 Yeoksam-Dong, Kangnam-Ku, Seoul 135-080, Korea
Tel: +82-2-558-3737, Fax: +82-2-558-5141