

100V N-Channel Enhancement Mode MOSFET

MTBC7N10K3

BV_{DSS}	100V
$I_D @ T_A=25^\circ C, V_{GS}=10V$	1A
$R_{DS(on)(TYP)} @ V_{GS}=10V, I_D=1A$	389m Ω
$R_{DS(on)(TYP)} @ V_{GS}=4.5V, I_D=1A$	413m Ω
$R_{DS(on)(TYP)} @ V_{GS}=4V, I_D=1A$	407m Ω

Features

- Lower gate charge.
- ESD protected gate.
- Pb-free lead plating and Halogen-free package.

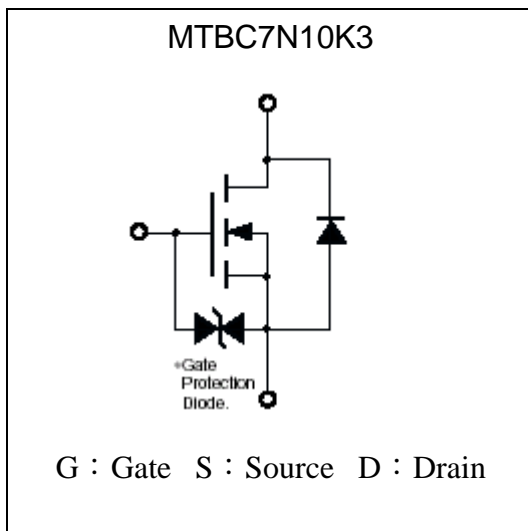
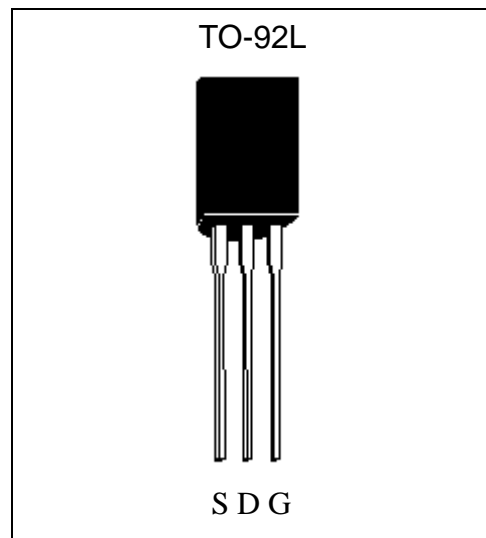
Equivalent Circuit

Outline

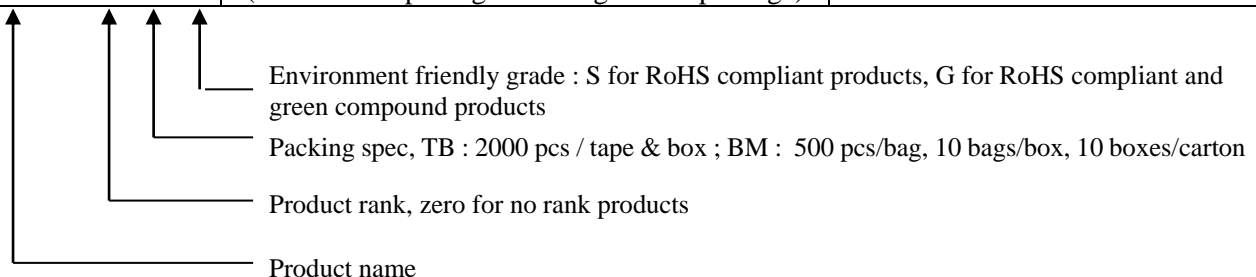
Ordering Information

Device	Package	Shipping
MTBC7N10K3-0-TB-G	TO-92L (Pb-free lead plating and halogen-free package)	2000 pcs / tape & box
MTBC7N10K3-0-BM-G	TO-92L (Pb-free lead plating and halogen-free package)	500 pcs / bag, 10 bags/box, 10 boxes/carton





Absolute Maximum Ratings (Tc=25°C, unless otherwise noted)

Parameter	Symbol	Limits	Unit
Drain-Source Voltage	V _{DS}	100	V
Gate-Source Voltage	V _{GS}	±20	
Continuous Drain Current	I _D	T _A =25°C, V _{GS} =10V	1
		T _A =70°C, V _{GS} =10V	0.8
Pulsed Drain Current	I _{DM}	4 (Note 1 & 2)	A
Power Dissipation	P _D	T _A =25°C	1
		T _A =70°C	0.64
Operating Junction and Storage Temperature	T _j , T _{stg}	-55 ~ +150	°C

Thermal Data

Parameter	Symbol	Value	Unit
Thermal Resistance, Junction-to-ambient, max	R _{θJA}	125	°C/W

Note :1. Pulse width limited by maximum junction temperature.
 2. Duty cycle ≤ 1%.

Electrical Characteristics (T_A=25°C, unless otherwise specified)

Symbol	Min.	Typ.	Max.	Unit	Test Conditions
Static					
BV _{DSS}	100	-	-	V	V _{GS} =0V, I _D =250μA
ΔBV _{DSS} /ΔT _j	-	107	-	mV/°C	I _D =1mA, referenced to 25°C
V _{GS(th)}	1	-	2.5	V	V _{DS} =10V, I _D =1mA
ΔV _{GS(th)} /ΔT _j	-	-3	-	mV/°C	I _D =1mA, referenced to 25°C
I _{GSS}	-	-	±10	μA	V _{GS} =±16V, V _{DS} =0V
I _{DSS}	-	-	1		V _{DS} =80V, V _{GS} =0V
	-	-	10		V _{DS} =80V, V _{GS} =0V, T _j =125°C
*R _{DS(ON)} ¹	-	389	520	mΩ	I _D =1A, V _{GS} =10V
	-	407	560		I _D =1A, V _{GS} =4.5V
	-	413	580		I _D =1A, V _{GS} =4V
*G _{FS} ¹	1	2.4	-	S	I _D =1A, V _{GS} =10V
Dynamic					
C _{iSS}	-	103	150	pF	V _{DS} =25V, V _{GS} =0V, f=1MHz
C _{oSS}	-	18	27		
C _{rSS}	-	17	24		
*t _{d(ON)} ^{1 2}	-	3.6	7.2	ns	V _{DS} =50V, I _D =0.5A, V _{GS} =10V, R _G =10Ω
*t _r ^{1 2}	-	16	24		
*t _{d(OFF)} ^{1 2}	-	17.2	26		
*t _f ^{1 2}	-	18.8	28		



*Qg ^{1 2}	-	1.6	3.2	nC	V _{DS} =50V, I _D =1A, V _{GS} =5V
*Qgs ^{1 2}	-	0.8	1.6		
*Qgd ^{1 2}	-	0.5	1.5		
Rg	-	18	-	Ω	f=1MHz
Source-Drain Diode					
I _S	-	-	0.8	A	
V _{SD} ¹	-	0.8	1.2	V	I _S =1A, V _{GS} =0V

¹ Pulse test : Pulse width≤300μs, Duty cycle≤2%

² Independent of operating temperature

³ Pulse width limited by maximum junction temperature

Typical Characteristics

Typical Output Characteristics

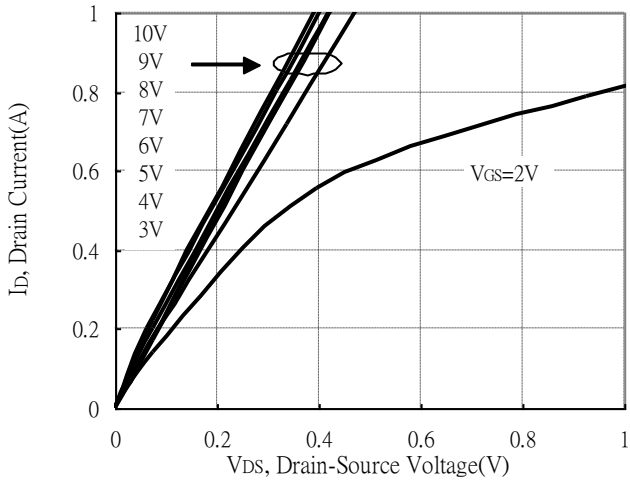

Typical Output Characteristics

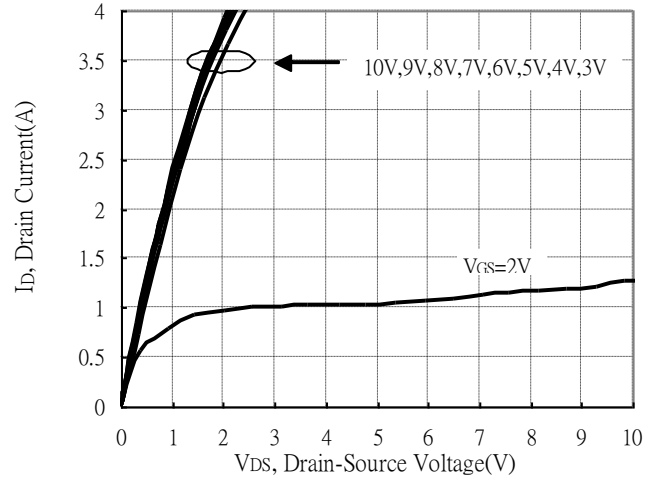

Brekdown Voltage vs Ambient Temperature

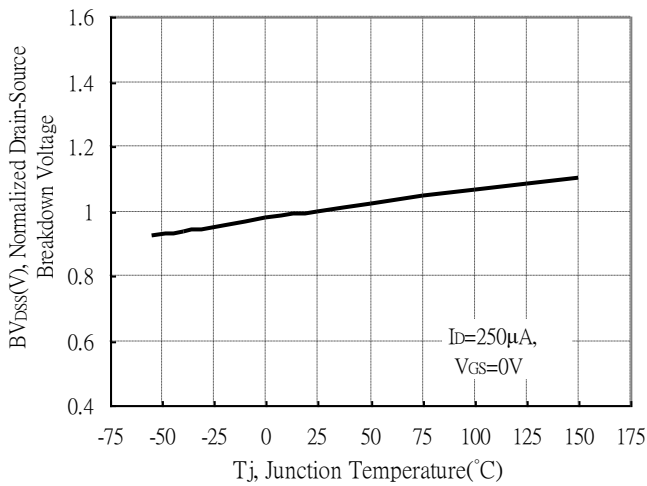

Typical Transfer Characteristics

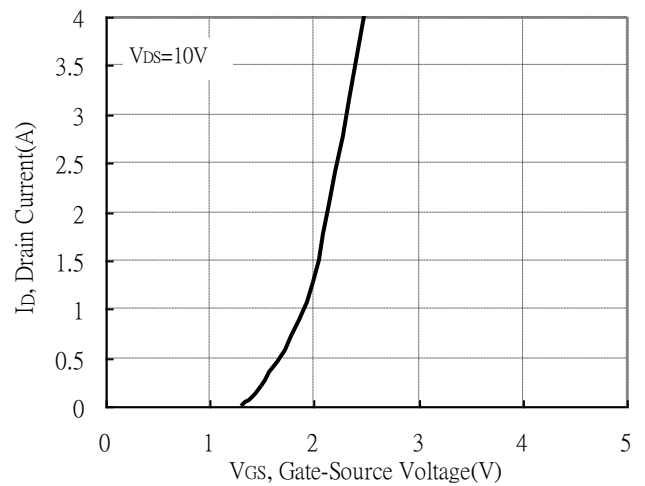

Static Drain-Source On-State resistance vs Drain Current

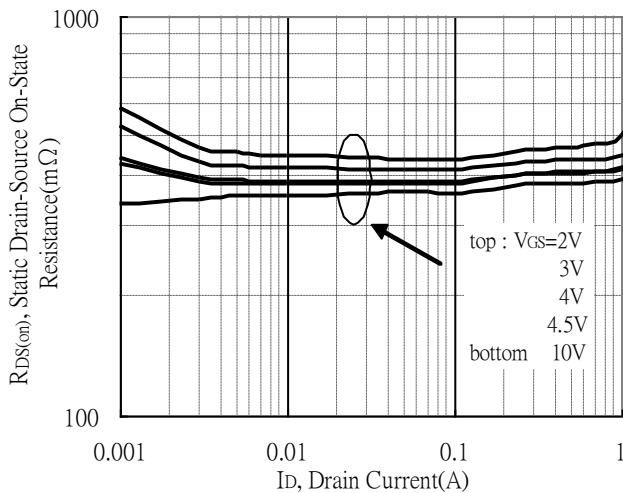

Reverse Drain Current vs Source-Drain Voltage

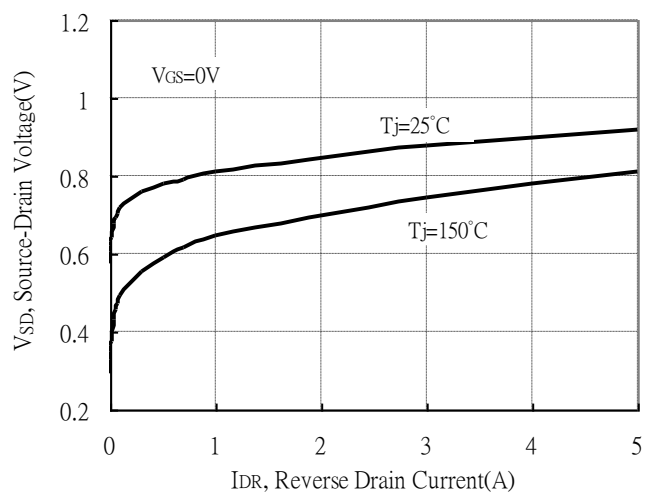

Typical Characteristics(Cont.)

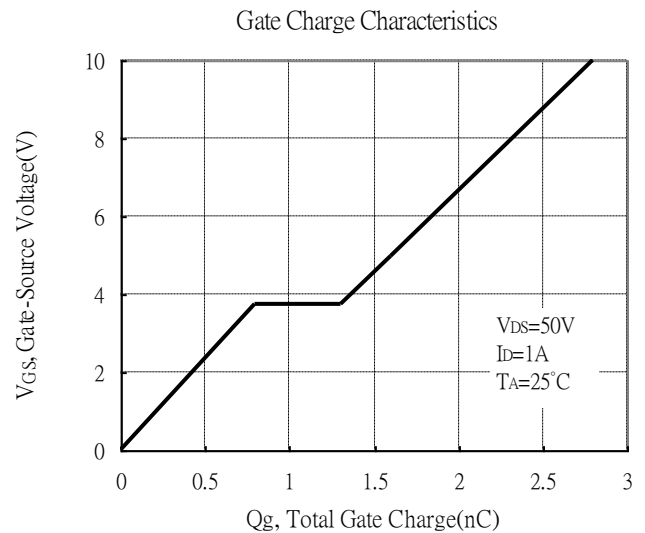
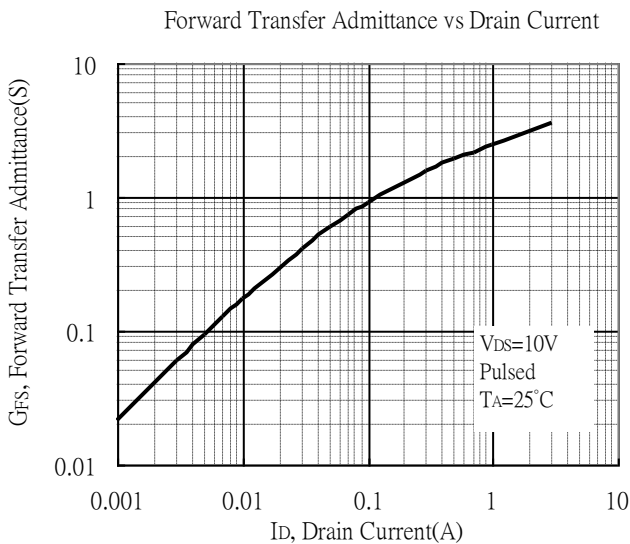
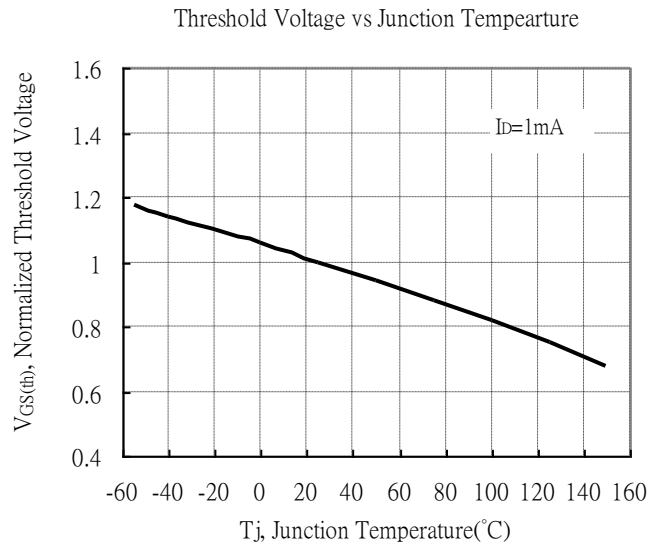
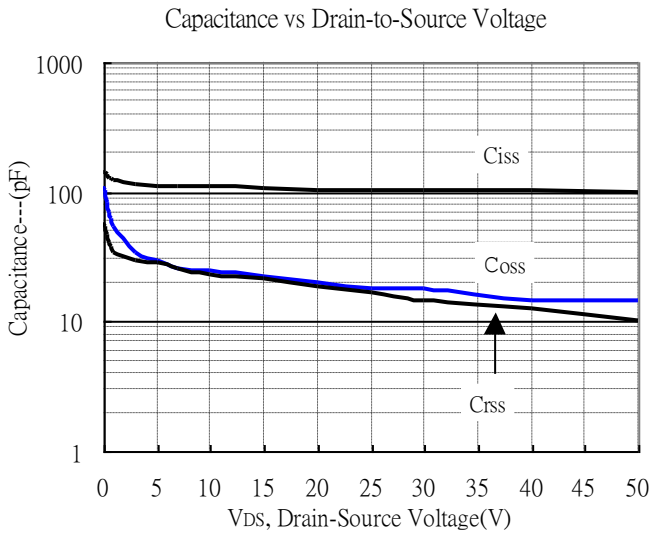
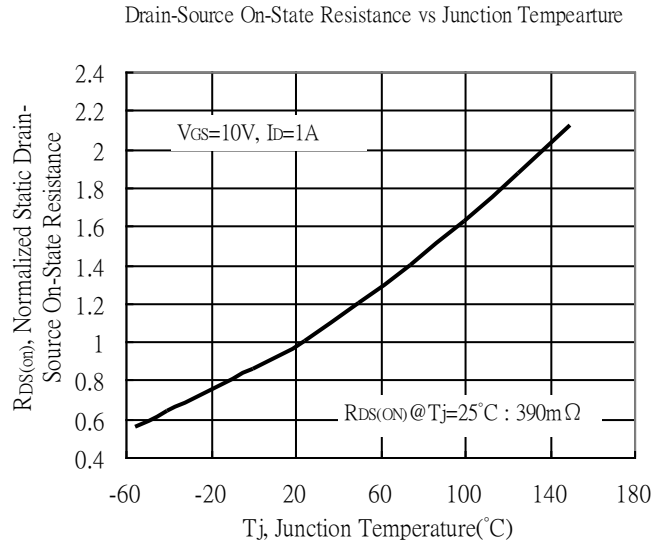
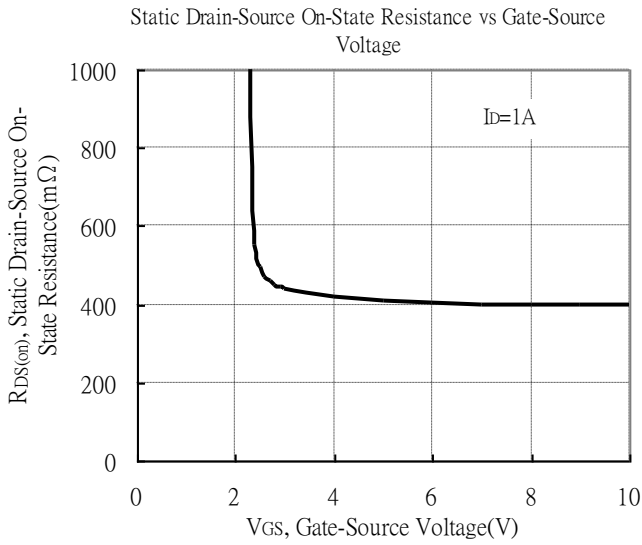

Typical Characteristics(Cont.)

Maximum Safe Operating Area

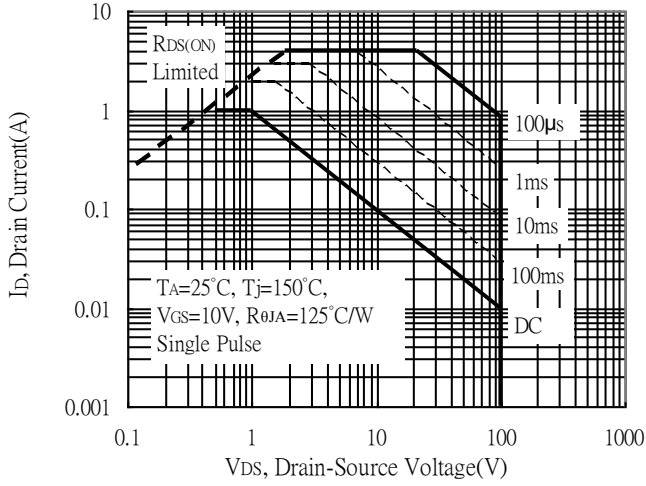

Maximum Drain Current vs Junction Temperature

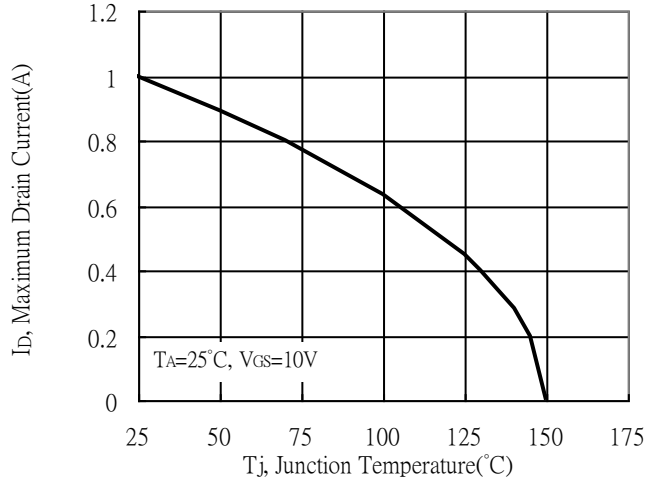

Power Derating Curve

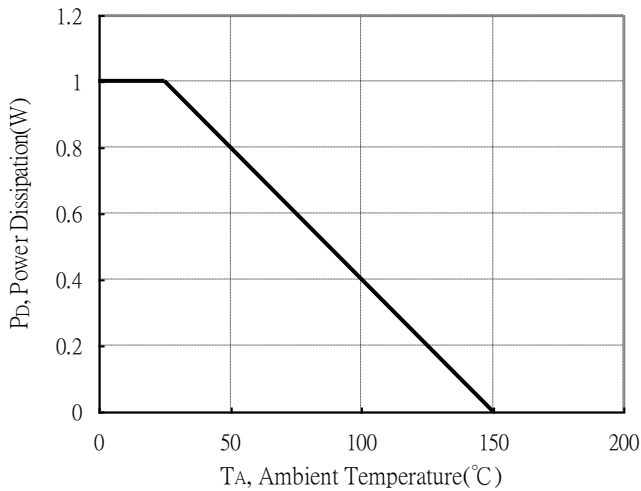

Single Pulse Maximum Power Dissipation

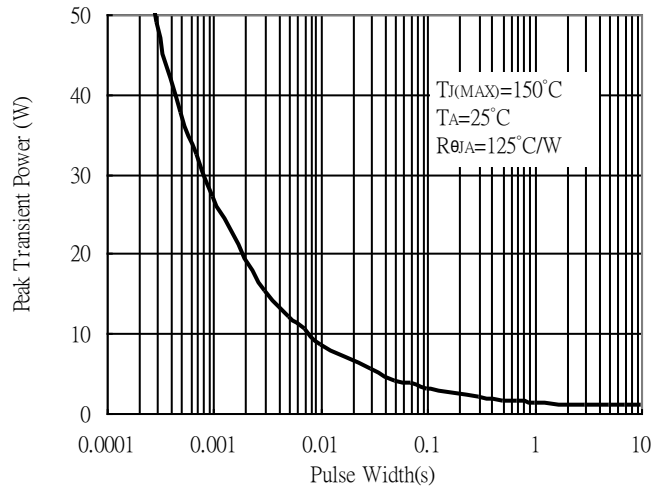

Typical Characteristics(Cont.)

Transient Thermal Response Curves

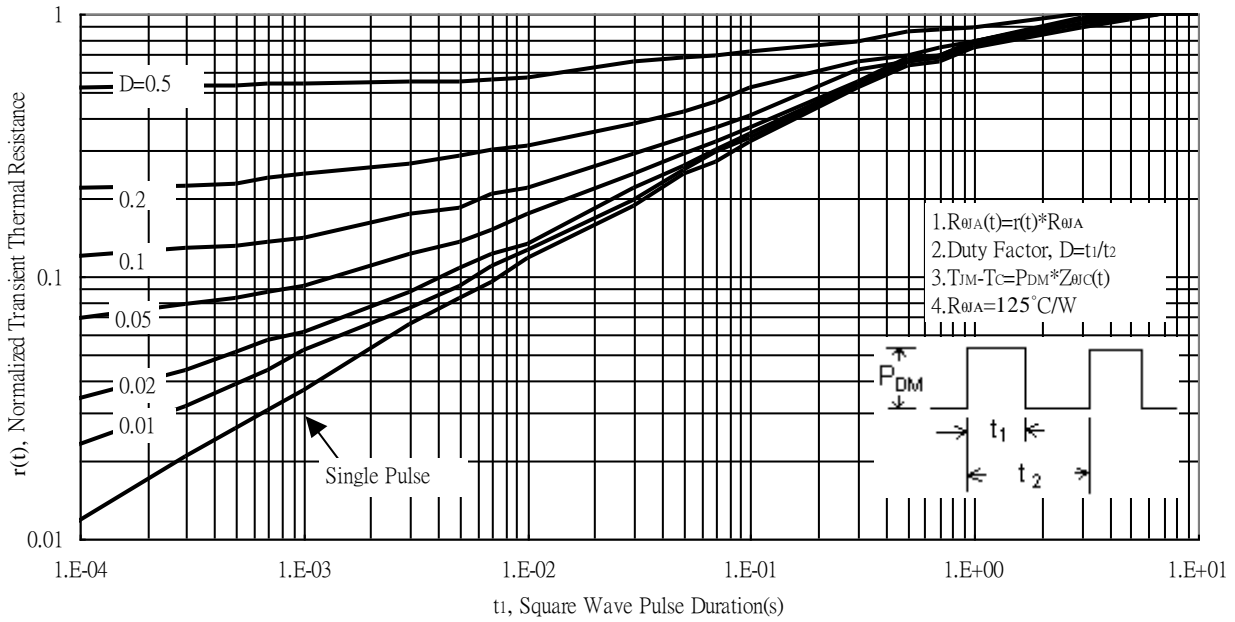

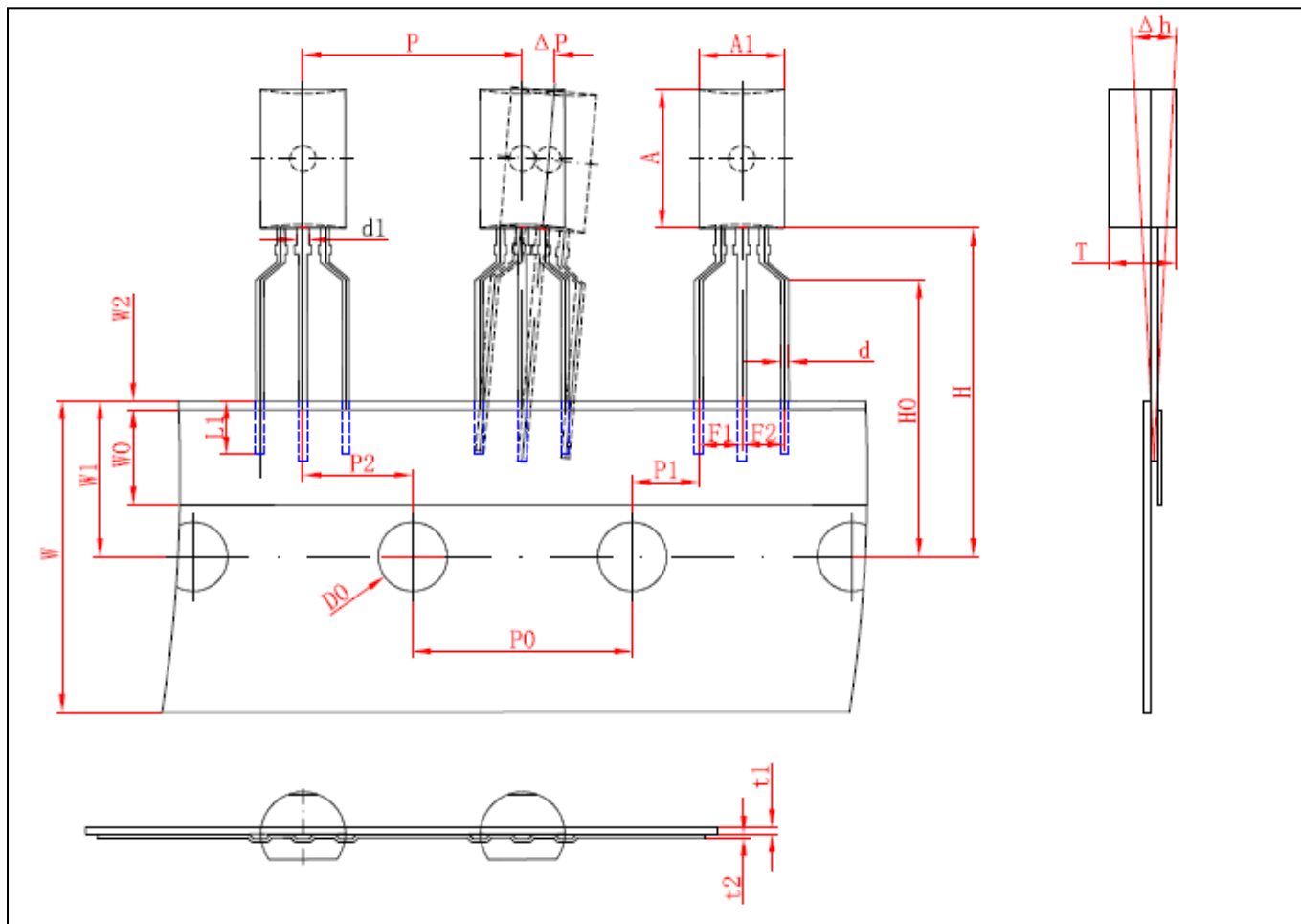
TO-92L Taping Outline

DIM	Item	Millimeters	
		Min.	Max.
A1	Component body width	4.70	5.10
A	Component body height	7.80	8.20
T	Component body thickness	3.70	4.10
d	Lead wire diameter	0.35	0.55
d1	Lead wire diameter 1	0.60	0.80
P	Pitch of component	12.40	13.00
P0	Feed hole pitch	12.50	12.90
P2	Hole center to component center	6.05	6.65
F1, F2	Lead to lead distance	2.20	2.80
Δh	Component alignment, F-R	-1.00	1.00
W	Tape width	17.50	19.00
W0	Hole down tape width	5.50	6.50
W1	Hole position	8.50	9.50
W2	Hole down tape position	-	1.00
H	Height of component from tape center	19.00	21.00
H0	Lead wire clinch height	15.50	16.50
L1	Lead wire (tape portion)	2.50	-
D0	Feed hole diameter	3.80	4.20
t1	Taped lead thickness	0.35	0.45
t2	Carrier tape thickness	0.15	0.25
P1	Position of hole	3.55	4.15
ΔP	Component alignment	-1.00	1.00

Recommended wave soldering condition

Product	Peak Temperature	Soldering Time
Pb-free devices	260 +0/-5 °C	5 +1/-1 seconds

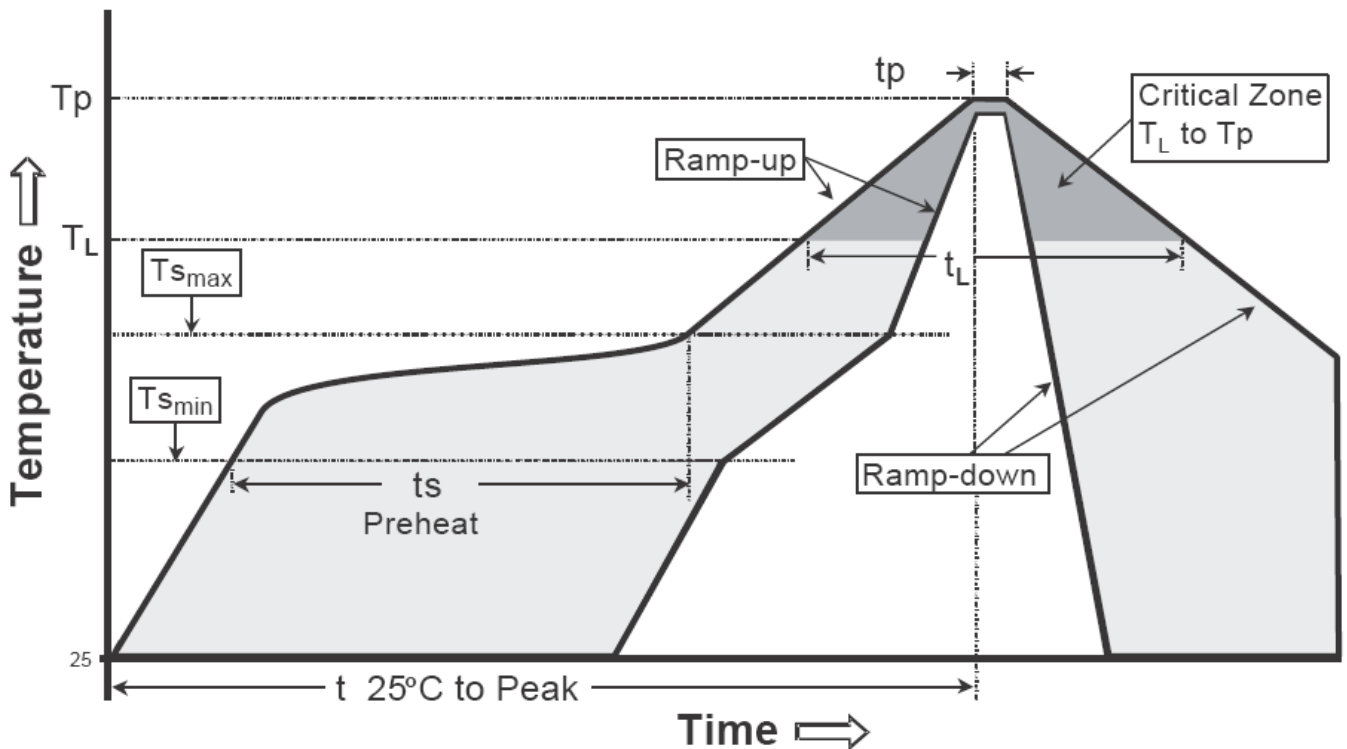
Recommended temperature profile for IR reflow

Profile feature	Sn-Pb eutectic Assembly	Pb-free Assembly
Average ramp-up rate (Tsmax to Tp)	3°C/second max.	3°C/second max.
Preheat		
-Temperature Min(Ts min)	100°C	150°C
-Temperature Max(Ts max)	150°C	200°C
-Time(ts min to ts max)	60-120 seconds	60-180 seconds
Time maintained above:		
-Temperature (Tl)	183°C	217°C
- Time (tl)	60-150 seconds	60-150 seconds
Peak Temperature(Tp)	240 +0/-5 °C	260 +0/-5 °C
Time within 5°C of actual peak temperature(tp)	10-30 seconds	20-40 seconds
Ramp down rate	6°C/second max.	6°C/second max.
Time 25 °C to peak temperature	6 minutes max.	8 minutes max.

Note : All temperatures refer to topside of the package, measured on the package body surface.

TO-92L Dimension

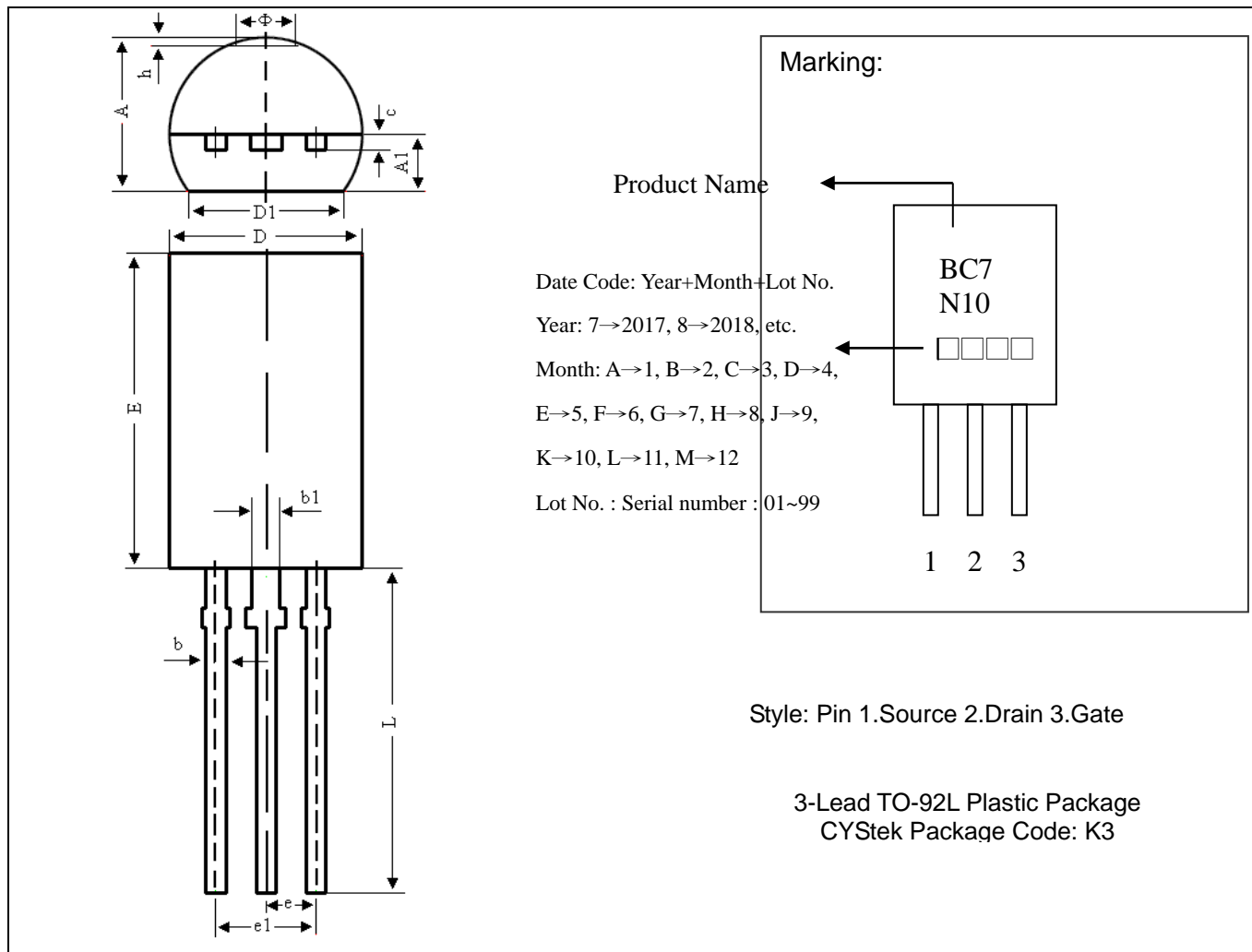

*: Typical

DIM	Inches		Millimeters		DIM	Inches		Millimeters	
	Min.	Max.	Min.	Max.		Min.	Max.	Min.	Max.
A	0.146	0.161	3.700	4.100	E	0.307	0.323	7.800	8.200
A1	0.050	0.062	1.280	1.580	e	*0.05		*1.270	
b	0.014	0.022	0.350	0.550	e1	0.096	0.104	2.440	2.640
b1	0.024	0.031	0.600	0.800	L	0.543	0.559	13.800	14.200
c	0.014	0.018	0.350	0.450	φ	-	0.063	-	1.600
D	0.185	0.201	4.700	5.100	h	0.000	0.012	0.000	0.300
D1	0.157	-	4.000	-					

Notes: 1.Controlling dimension: millimeters.
 2.Maximum lead thickness includes lead finish thickness, and minimum lead thickness is the minimum thickness of base material.
 3.If there is any question with packing specification or packing method, please contact your local CYStek sales office.

Material:

- Lead: Pure tin plated.
- Mold Compound: Epoxy resin family, flammability solid burning class: UL94V-0.

Important Notice:

- All rights are reserved. Reproduction in whole or in part is prohibited without the prior written approval of CYStek.
- CYStek reserves the right to make changes to its products without notice.
- CYStek **semiconductor products are not warranted to be suitable for use in Life-Support Applications, or systems.**
- CYStek assumes no liability for any consequence of customer product design, infringement of patents, or application assistance.