

Connectorized Amplifier

ZX60-4016E+

50Ω 20 MHz to 4 GHz

Features

- Wide bandwidth, 20 MHz to 4 GHz
- Low noise figure, 3.9 dB typ.
- Output power up to 17.4 dBm typ.
- Protected by US patent 6,790,049

Applications

- Cellular
- PCS
- Communication receivers & transmitters
- Lab
- Instrumentation
- Test equipment



CASE STYLE: GC957

Connectors	Model
SMA	ZX60-4016E-S+

+RoHS Compliant

The +Suffix identifies RoHS Compliance. See our web site for RoHS Compliance methodologies and qualifications

Electrical Specifications at T_{AMB} = 25°C

MODEL NO.	FREQ. (GHz) f _L - f _U	DC VOLTAGE @ Pin V+ (V)	GAIN over frequency in GHz Typ (dB)					MAXIMUM POWER (dBm) Output (1 dB Comp.) Typ. f _L f _U	DYNAMIC RANGE		VSWR (:1) Typ.				ACTIVE DIRECTIVITY (dB) Isolation-Gain Typ.	DC OPERATING CURRENT @ Pin V+ (mA)			
			0.1	1.0	2.0	3.0	4.0		Min.at 2 GHz	NF (dB) Typ.	IP3 (dBm) Typ.	In		Out		Typ.	Typ.	Max.	
			GHz	GHz	GHz	GHz	GHz		GHz	f _L -3 GHz	3-f _U GHz	f _L -3 GHz	3-f _U GHz						
ZX60-4016E+	0.02 - 4	12.0	20.1	19.5	18.2	16.5	14.9	15.7	17.4	14.5	3.9	30.0	1.25	1.3	1.3	1.2	3-6	64	75

Maximum Ratings

Operating Temperature -45°C to 80°C case

Storage Temperature -55°C to 100°C

DC Voltage 12.5 V

Input Power(no Damage) 13 dBm

Power 950 mW

Permanent damage may occur if any of these limits are exceeded.



NOTE: When soldering the DC connections, caution must be used to avoid overheating the DC terminals. See Application Note [AN-40-10](#).

Outline Drawing

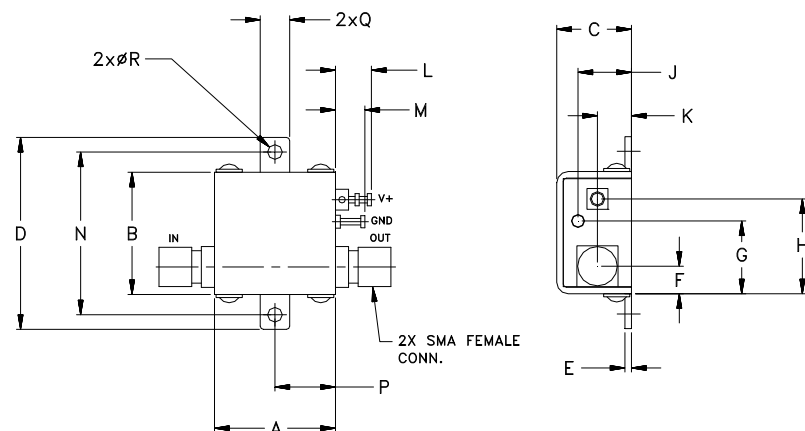

Outline Dimensions (inch/mm)

A	B	C	D	E	F	G	H	J	K	L	M	N	P	Q	R	WT.
.74	.75	.46	1.18	.04	.17	.45	.59	.33	.21	.22	.18	1.00	.37	.18	.106	GRAM
18.80	19.05	11.68	29.97	1.02	4.32	11.43	14.99	8.38	5.33	5.59	4.57	25.40	9.40	4.57	2.69	23.0

Notes

- Performance and quality attributes and conditions not expressly stated in this specification document are intended to be excluded and do not form a part of this specification document.
- Electrical specifications and performance data contained in this specification document are based on Mini-Circuit's applicable established test performance criteria and measurement instructions.
- The parts covered by this specification document are subject to Mini-Circuits standard limited warranty and terms and conditions (collectively, "Standard Terms"); Purchasers of this part are entitled to the rights and benefits contained therein. For a full statement of the Standard Terms and the exclusive rights and remedies thereunder, please visit Mini-Circuits' website at www.minicircuits.com/MCLStore/terms.jsp



www.minicircuits.com P.O. Box 350166, Brooklyn, NY 11235-0003 (718) 934-4500 sales@minicircuits.com

Typical Performance Data & Curves at 25°C

ZX60-4016E+

FREQUENCY (MHz)	GAIN (dB)	DIRECTIVITY (dB)	VSWR IN (:1)	VSWR OUT (:1)	POWER OUT @1dB COMPRESSION (dBm)	IP3 (dBm)	NF (dB)
20	19.93	3.47	1.31	1.41	17.64	31.98	3.78
50	20.09	3.11	1.28	1.34	17.89	32.36	3.64
100	20.14	2.99	1.28	1.31	17.93	32.64	3.51
250	20.10	3.04	1.29	1.30	17.97	32.89	3.65
500	19.94	3.13	1.27	1.28	17.94	32.28	3.73
750	19.83	3.21	1.26	1.27	17.84	32.03	3.81
1000	19.54	3.35	1.22	1.24	17.95	32.66	3.82
1250	19.34	3.57	1.19	1.20	17.61	31.91	3.66
1500	18.96	3.59	1.18	1.18	17.68	31.35	3.86
1750	18.56	3.80	1.18	1.16	17.83	31.57	3.78
2000	18.24	4.02	1.21	1.11	17.68	31.24	3.97
2250	17.85	4.38	1.25	1.07	17.56	31.10	3.93
2500	17.42	4.75	1.30	1.04	17.40	30.48	4.01
2750	16.94	4.97	1.35	1.02	16.95	29.71	3.96
3000	16.51	5.37	1.40	1.04	16.20	29.86	4.09
3250	15.94	5.45	1.43	1.05	15.82	28.85	4.29
3500	15.68	5.86	1.47	1.08	15.45	27.57	4.36
3700	15.34	6.00	1.48	1.09	14.94	28.90	4.41
3900	15.07	6.03	1.46	1.10	14.53	27.18	4.46
4000	14.93	5.98	1.48	1.09	14.35	27.84	4.45

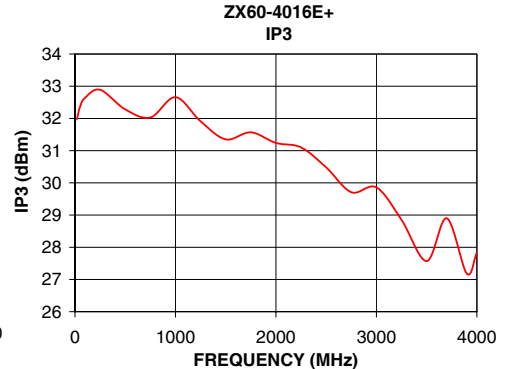
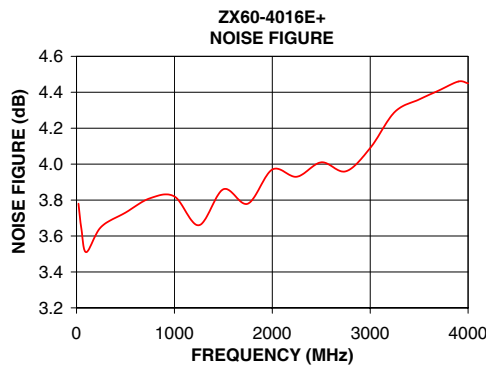
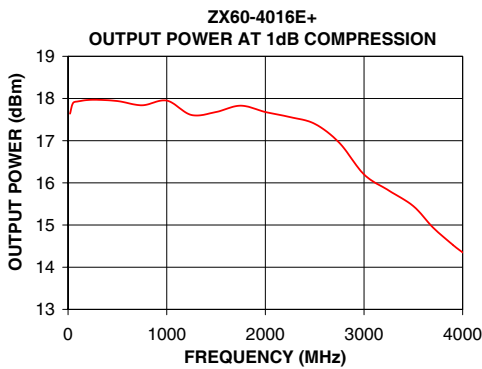
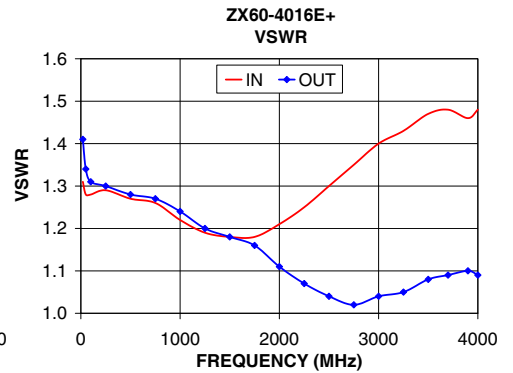
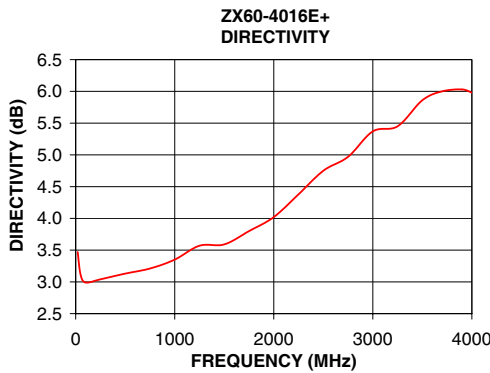
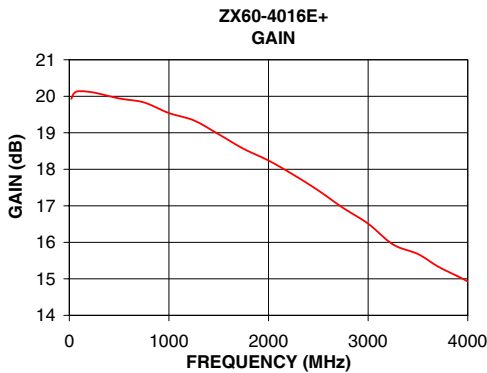

Notes

- A. Performance and quality attributes and conditions not expressly stated in this specification document are intended to be excluded and do not form a part of this specification document.
- B. Electrical specifications and performance data contained in this specification document are based on Mini-Circuit's applicable established test performance criteria and measurement instructions.
- C. The parts covered by this specification document are subject to Mini-Circuits standard limited warranty and terms and conditions (collectively, "Standard Terms"); Purchasers of this part are entitled to the rights and benefits contained therein. For a full statement of the Standard Terms and the exclusive rights and remedies thereunder, please visit Mini-Circuits' website at www.minicircuits.com/MCLStore/terms.jsp

