

## Phase leg Full SiC Power Module

$V_{DSS} = 1200V$   
 $R_{DS(on)} = 14m\Omega \text{ typ @ } T_j = 25^\circ C$   
 $I_D = 180A \text{ @ } T_c = 25^\circ C$

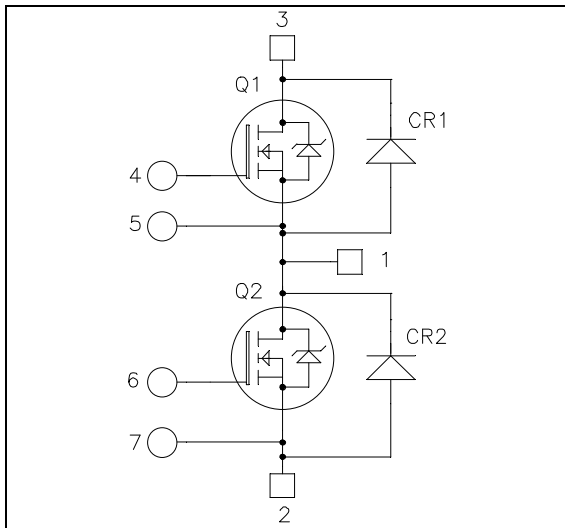

### Application

- Welding converters
- Switched Mode Power Supplies
- Uninterruptible Power Supplies
- Motor control

### Features

- **SiC Power MOSFET**
  - Low  $R_{DS(on)}$
  - High temperature performance
- **SiC Schottky Diode**
  - Zero reverse recovery
  - Zero forward recovery
  - Temperature Independent switching behavior
  - Positive temperature coefficient on VF
- Kelvin emitter for easy drive
- High level of integration
- AlN substrate for improved thermal performance
- M6 power connectors

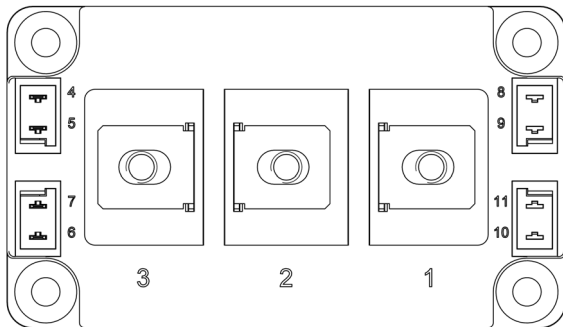

### Benefits

- Stable temperature behavior
- Very rugged
- Direct mounting to heatsink (isolated package)
- Low junction to case thermal resistance
- RoHS Compliant

All ratings @  $T_j = 25^\circ C$  unless otherwise specified

### Absolute maximum ratings

Symbol	Parameter	Max ratings	Unit
$V_{DSS}$	Drain - Source Voltage	1200	V
$I_D$	Continuous Drain Current	$T_c = 25^\circ C$	225
		$T_c = 80^\circ C$	180
$I_{DM}$	Pulsed Drain current	450	A
$V_{GS}$	Gate - Source Voltage	-10/25V	V
$R_{DS(on)}$	Drain - Source ON Resistance	17	m $\Omega$
$P_D$	Power Dissipation	$T_c = 25^\circ C$	1430
			W

**CAUTION:** These Devices are sensitive to Electrostatic Discharge. Proper Handling Procedures Should Be Followed. See application note APT0502 on [www.microsemi.com](http://www.microsemi.com)



**Electrical Characteristics**

Symbol	Characteristic	Test Conditions	Min	Typ	Max	Unit
I <sub>DSS</sub>	Zero Gate Voltage Drain Current	V <sub>GS</sub> = 0V, V <sub>DS</sub> = 1200V		60	600	μA
R <sub>DS(on)</sub>	Drain – Source on Resistance	V <sub>GS</sub> = 20V I <sub>D</sub> = 120A		14 23	17	mΩ
V <sub>GS(th)</sub>	Gate Threshold Voltage	V <sub>GS</sub> = V <sub>DS</sub> ; I <sub>D</sub> = 6mA	1.7	3		V
I <sub>GSS</sub>	Gate – Source Leakage Current	V <sub>GS</sub> = 20 V, V <sub>DS</sub> = 0V			600	nA

**Dynamic Characteristics**

Symbol	Characteristic	Test Conditions	Min	Typ	Max	Unit
C <sub>iss</sub>	Input Capacitance	V <sub>GS</sub> = 0V		15.4		nF
C <sub>oss</sub>	Output Capacitance	V <sub>DS</sub> = 1000V		0.72		
C <sub>rss</sub>	Reverse Transfer Capacitance	f = 1MHz		0.12		
Q <sub>g</sub>	Total gate Charge	V <sub>GS</sub> = -5/20V		816		nC
Q <sub>gs</sub>	Gate – Source Charge	V <sub>Bus</sub> = 600V		240		
Q <sub>gd</sub>	Gate – Drain Charge	I <sub>D</sub> = 120A		240		
T <sub>d(on)</sub>	Turn-on Delay Time	Inductive Switching V <sub>GS</sub> = -5/20V ; V <sub>Bus</sub> = 800V I <sub>D</sub> = 120A ; T <sub>J</sub> = 150°C R <sub>G</sub> = 0.8Ω		10		ns
T <sub>r</sub>	Rise Time			10		
T <sub>d(off)</sub>	Turn-off Delay Time			45		
T <sub>f</sub>	Fall Time			30		
E <sub>on</sub>	Turn on Energy	Inductive Switching V <sub>GS</sub> = -5/+20V V <sub>Bus</sub> = 600V		2.6		mJ
E <sub>off</sub>	Turn off Energy	I <sub>D</sub> = 120A R <sub>G</sub> = 0.8Ω		1.5		
R <sub>Gint</sub>	Internal gate resistance			0.55		Ω
R <sub>thJC</sub>	Junction to Case Thermal Resistance				0.105	°C/W

**Body diode ratings and characteristics**

Symbol	Characteristic	Test Conditions	Min	Typ	Max	Unit	
V <sub>SD</sub>	Diode Forward Voltage	V <sub>GS</sub> = 0V, I <sub>SD</sub> = 120A		3.9		V	
t <sub>rr</sub>	Reverse Recovery Time	I <sub>SD</sub> = 120A ; V <sub>GS</sub> = -2V V <sub>R</sub> = 800V ; di <sub>F</sub> /dt = 600A/μs		140		ns	
Q <sub>rr</sub>	Reverse Recovery Charge				690		nC
I <sub>rr</sub>	Reverse Recovery Current				12		A



**SiC schottky diode ratings and characteristics**

Symbol	Characteristic	Test Conditions	Min	Typ	Max	Unit
V <sub>RRM</sub>	Peak Repetitive Reverse Voltage				1200	V
I <sub>RRM</sub>	Reverse Leakage Current	V <sub>R</sub> =1200V	T <sub>j</sub> = 25°C	60	1200	μA
			T <sub>j</sub> = 175°C	3000		
I <sub>F</sub>	Forward Current			60		A
V <sub>F</sub>	Diode Forward Voltage	I <sub>F</sub> = 60A	T <sub>j</sub> = 25°C	1.5	1.8	V
			T <sub>j</sub> = 175°C	2.3		
Q <sub>C</sub>	Total Capacitive Charge	I <sub>F</sub> = 60A, V <sub>R</sub> = 600V di/dt = 3000A/μs		720		nC
C	Total Capacitance	f = 1MHz, V <sub>R</sub> = 200V		690		pF
		f = 1MHz, V <sub>R</sub> = 400V		510		
R <sub>thJC</sub>	Junction to Case Thermal Resistance				0.19	°C/W

**Thermal and package characteristics**

Symbol	Characteristic	Min	Max	Unit		
V <sub>ISOL</sub>	RMS Isolation Voltage, any terminal to case t=1 min, 50/60Hz	4000		V		
T <sub>J</sub>	Operating junction temperature range	-40	175	°C		
T <sub>JOP</sub>	Recommended junction temperature under switching conditions	-40	T <sub>Jmax</sub> -25			
T <sub>STG</sub>	Storage Temperature Range	-40	125			
T <sub>C</sub>	Operating Case Temperature	-40	125			
Torque	Mounting torque	For terminals	M6		3	5
		To Heatsink	M6	3	5	
Wt	Package Weight			350	g	

**Package outline (dimensions in mm)**

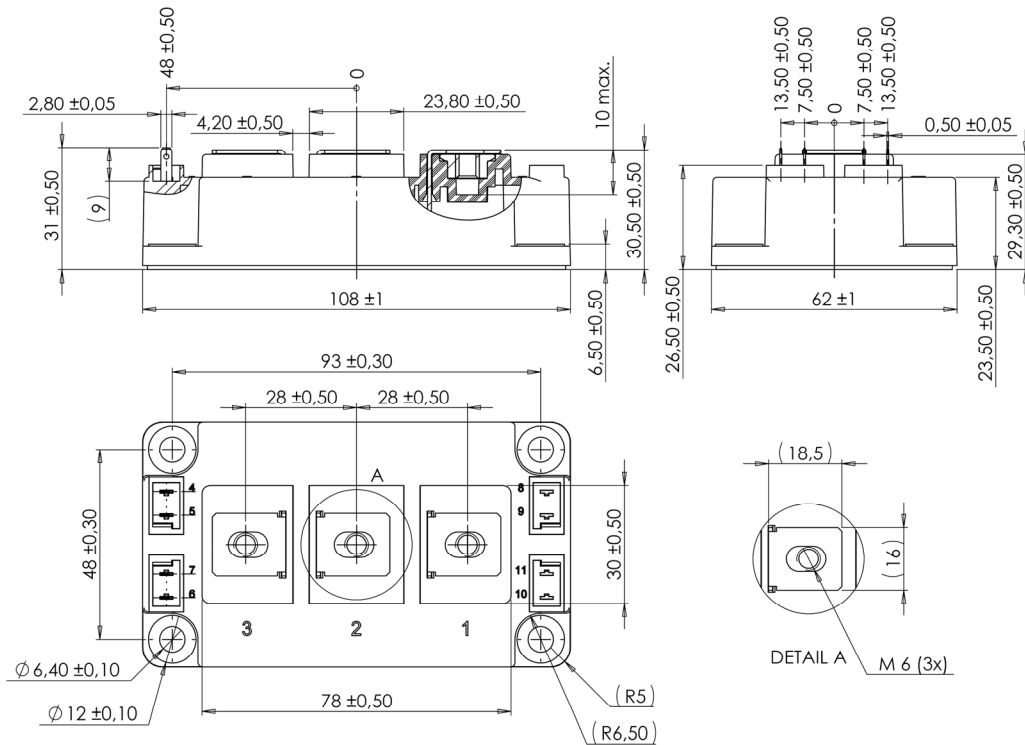

## Typical SiC MOSFET Performance Curve

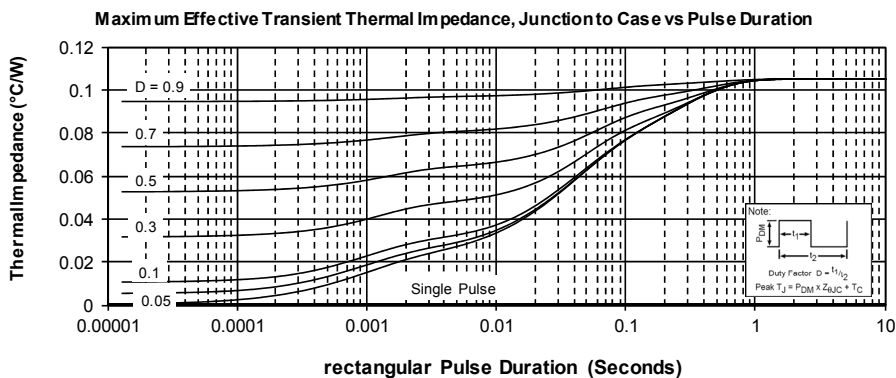
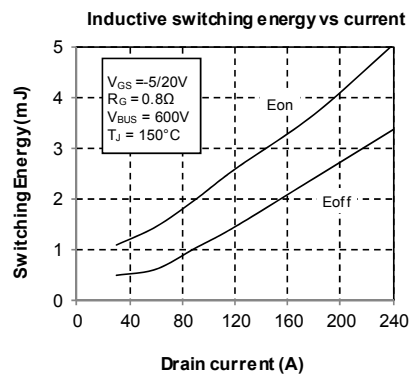
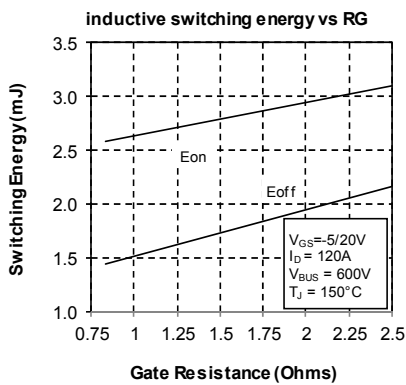
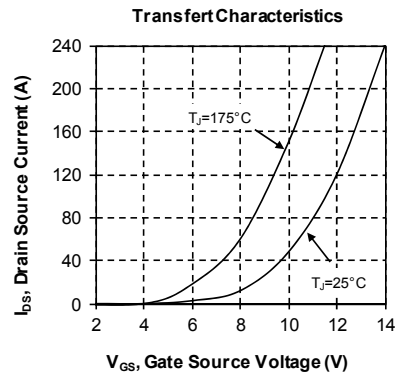
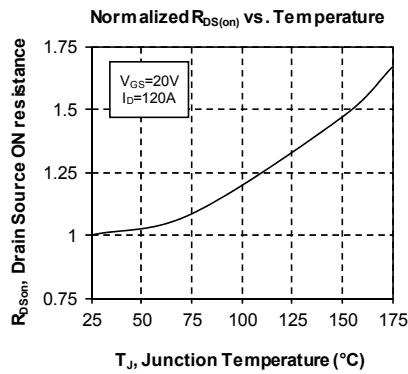
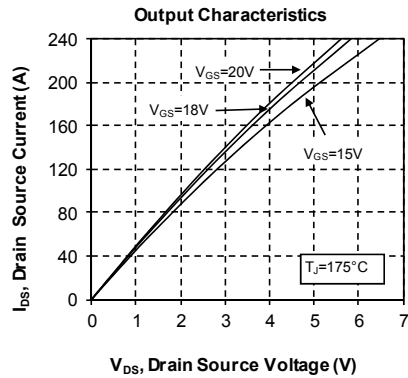
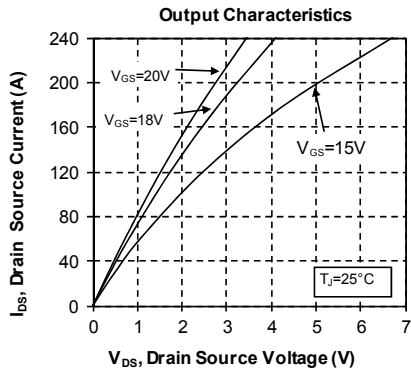

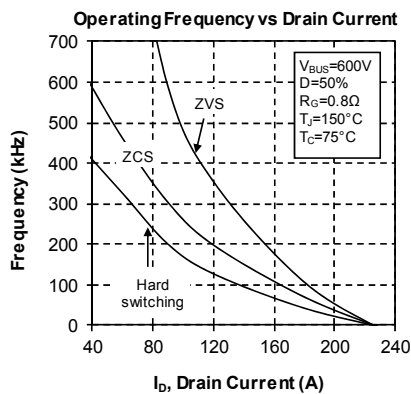
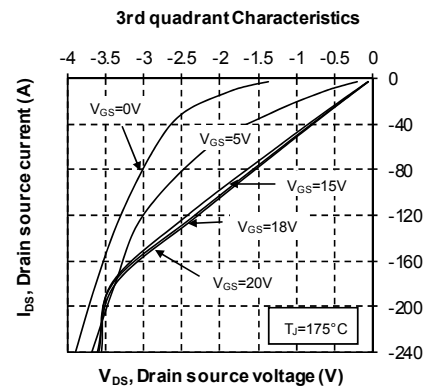
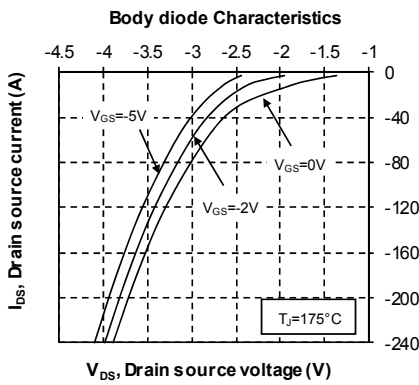
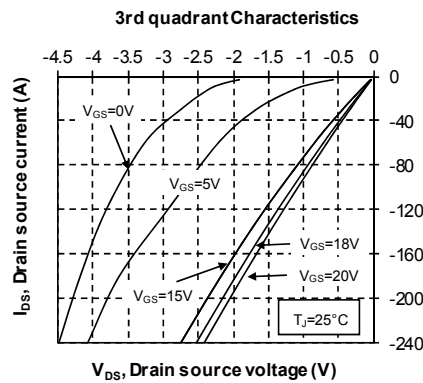
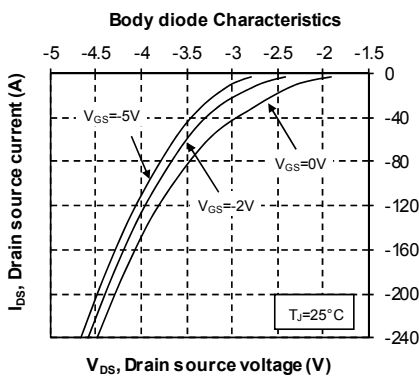
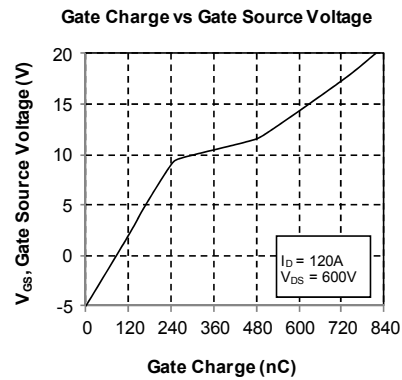
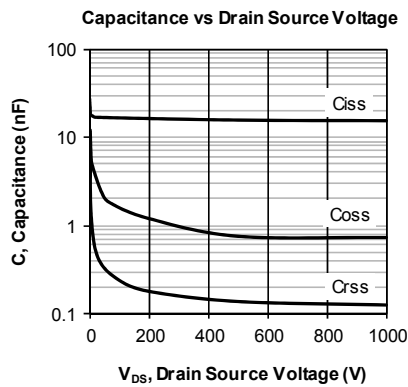



## Typical SiC diode Performance Curve

Maximum Effective Transient Thermal Impedance, Junction to Case vs Pulse Duration

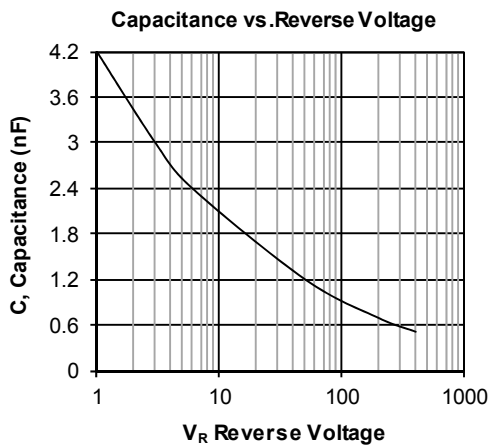
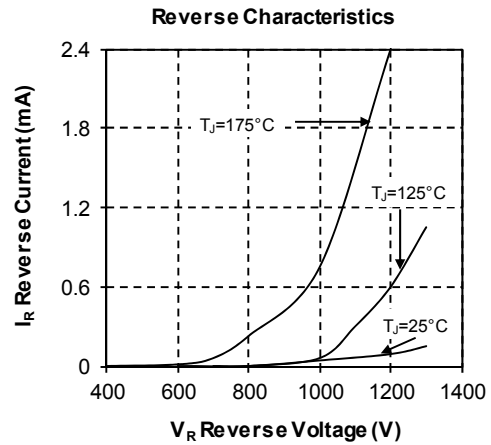
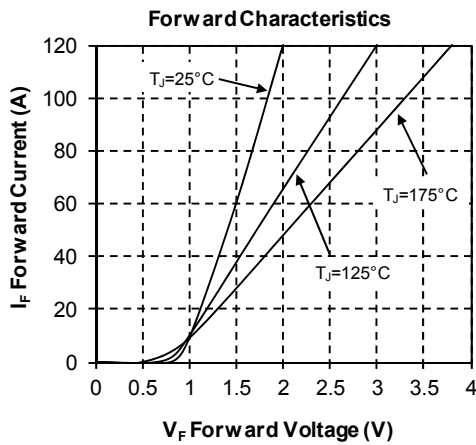
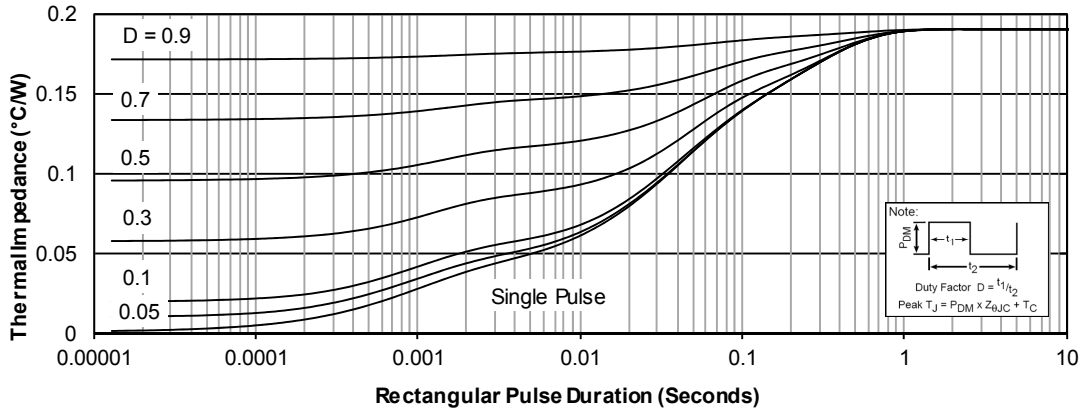



---

DISCLAIMER

The information contained in the document (unless it is publicly available on the Web without access restrictions) is PROPRIETARY AND CONFIDENTIAL information of Microsemi and cannot be copied, published, uploaded, posted, transmitted, distributed or disclosed or used without the express duly signed written consent of Microsemi. If the recipient of this document has entered into a disclosure agreement with Microsemi, then the terms of such Agreement will also apply. This document and the information contained herein may not be modified, by any person other than authorized personnel of Microsemi. No license under any patent, copyright, trade secret or other intellectual property right is granted to or conferred upon you by disclosure or delivery of the information, either expressly, by implication, inducement, estoppels or otherwise. Any license under such intellectual property rights must be approved by Microsemi in writing signed by an officer of Microsemi.

Microsemi reserves the right to change the configuration, functionality and performance of its products at anytime without any notice. This product has been subject to limited testing and should not be used in conjunction with life-support or other mission-critical equipment or applications. Microsemi assumes no liability whatsoever, and Microsemi disclaims any express or implied warranty, relating to sale and/or use of Microsemi products including liability or warranties relating to fitness for a particular purpose, merchantability, or infringement of any patent, copyright or other intellectual property right. Any performance specifications believed to be reliable but are not verified and customer or user must conduct and complete all performance and other testing of this product as well as any user or customers final application. User or customer shall not rely on any data and performance specifications or parameters provided by Microsemi. It is the customer's and user's responsibility to independently determine suitability of any Microsemi product and to test and verify the same. The information contained herein is provided "AS IS, WHERE IS" and with all faults, and the entire risk associated with such information is entirely with the User. Microsemi specifically disclaims any liability of any kind including for consequential, incidental and punitive damages as well as lost profit. The product is subject to other terms and conditions which can be located on the web at <http://www.microsemi.com/legal/tnc.asp>

Life Support Application

Seller's Products are not designed, intended, or authorized for use as components in systems intended for space, aviation, surgical implant into the body, in other applications intended to support or sustain life, or for any other application in which the failure of the Seller's Product could create a situation where personal injury, death or property damage or loss may occur (collectively "Life Support Applications").

Buyer agrees not to use Products in any Life Support Applications and to the extent it does it shall conduct extensive testing of the Product in such applications and further agrees to indemnify and hold Seller, and its officers, employees, subsidiaries, affiliates, agents, sales representatives and distributors harmless against all claims, costs, damages and expenses, and attorneys' fees and costs arising, directly or indirectly, out of any claims of personal injury, death, damage or otherwise associated with the use of the goods in Life Support Applications, even if such claim includes allegations that Seller was negligent regarding the design or manufacture of the goods.

Buyer must notify Seller in writing before using Seller's Products in Life Support Applications. Seller will study with Buyer alternative solutions to meet Buyer application specification based on Seller's sales conditions applicable for the new proposed specific part.