

ASMC-PxB9-Txxxx

Envisium™ Power PLCC-4 Surface Mount LED

Overview

The Envisium LED is the premier class of mid-Power LEDs using TS AlInGaP chip technology. Envisium LEDs offer unparalleled performance, engineering, and design flexibility.

Description

The Envisium™ Power PLCC-4 SMT LED is an extension of the Broadcom® PLCC-4 SMT LEDs. The package can be driven at high current due to its superior package design. The product is able to dissipate the heat more efficiently compared to the conventional PLCC-2 SMT LEDs. These LEDs produce higher light output with better flux performance compared to the conventional PLCC-4 SMT LEDs.

The Envisium Power PLCC-4 SMT LEDs are designed for higher reliability and better performance, and operate under a wide range of environmental conditions. The performance characteristics of these new mid-power LEDs make them uniquely suitable for use in harsh conditions such as in automotive applications, and in electronics signs and signals.

To facilitate easy pick and place assembly, the LEDs are packed in EIA-compliant tape and reel. Every reel is shipped in single intensity and color bin (except for red), to provide close uniformity. These LEDs are compatible with the IR solder reflow process. Due to the high reliability feature of these products, they also can be mounted using through-the-wave soldering process.

The Envisium Power PLCC-4 SMT LED is available in three colors: red, red-orange, and amber.

Features

- Industry-standard PLCC-4 (Plastic Leaded Chip Carrier)
- High reliability LED package
- High brightness with optimum flux performance using TS AlInGaP dice technologies
- Available in Red, Red Orange, and Amber colors
- High optical efficiency
- Higher ambient temperature at the same current possible compared to PLCC-2
- Super wide viewing angle at 120°
- Available in 8-mm carrier tape on 7-inch reel
- Compatible with both IR and TTW soldering process

Applications

- Interior automotive
 - Instrument panel backlighting
 - Central console backlighting
 - Navigation and audio system
 - Push button backlighting
- Exterior automotive
 - Turn signals
 - Side repeaters
 - CHMSL
 - Rear combination lamp
 - Puddle light
- Electronic signs and signals
 - Channel lettering
 - Contour lighting
 - Indoor variable message sign
- Office automation, home appliances, industrial equipment
 - Front panel backlighting
 - Push button backlighting
 - Display backlighting

Package Dimensions

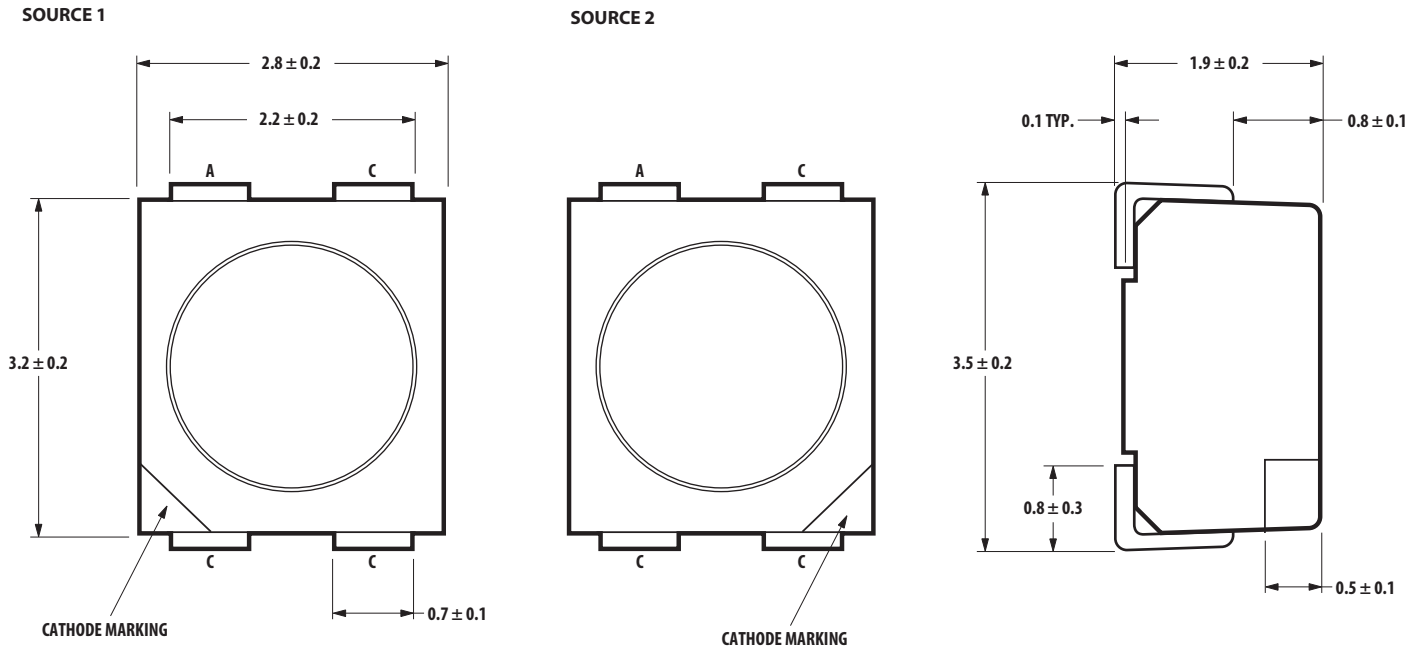

NOTE: ALL DIMENSIONS IN mm.

Device Selection Guide (T_J = 25 °C)

Color	Part Number	Min. IV (mcd)	Max. IV (mcd)	Test Current (mA)	Dice Technology
Red	ASMC-PRB9-TV005	715.0	—	50	AllnGaP
Red Orange	ASMC-PHB9-TW005	1125.0	—	50	AllnGaP
Amber	ASMC-PAB9-TV005	715.0	—	50	AllnGaP

NOTE:

1. The luminous intensity, I_V, is measured at the mechanical axis of the lamp package. The actual peak of the spatial radiation pattern may not be aligned with this axis.
2. Φ_V is the total luminous flux output as measured with an integrating sphere at mono pulse conditions.
3. Tolerance = ±12%.

Part Numbering System

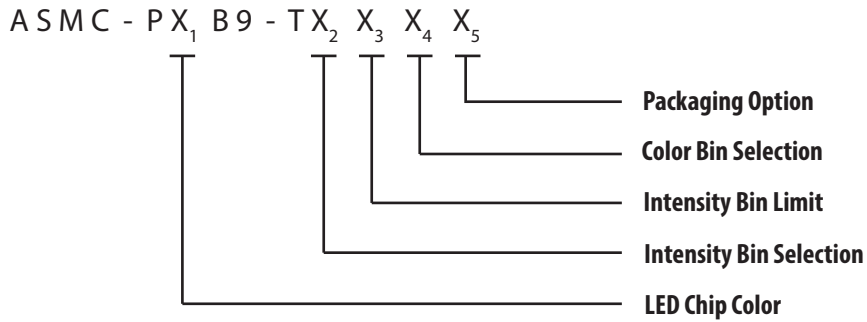

Absolute Maximum Ratings ($T_A = 25\text{ }^\circ\text{C}$)

Parameters	ASMC-PxB9-Txxxx
DC Forward Current ^a	70 mA ^{b,c}
Peak Forward Current ^d	200 mA
Power Dissipation	240 mW
Reverse Voltage	5V
Junction Temperature	125°C
Operating Temperature	-40°C to +100°C
Storage Temperature	-40°C to +100°C

- Derate linearly as shown in [Figure 4](#).
- Drive current between 10 mA and 70 mA is recommended for best long-term performance.
- Operation at currents below 5 mA is not recommended.
- Duty factor = 10%, frequency = 1 kHz.

Optical Characteristics ($T_J = 25\text{ }^\circ\text{C}$)

Color	Part Number	Dice Technology	Peak Wavelength λ_{PEAK} (nm)	Dominant Wavelength λ_D^a (nm)	Viewing Angle $\theta_{1/2}^b$ (Degrees)	Luminous Efficacy η_V^c (lm/W)	Luminous Intensity/ Total Flux I_V^d (mcd)/ Φ_V^d (lm)
			Typ.	Typ.	Typ.	Typ.	Typ.
Red	ASMC-PRB9-Txxx5	AllnGaP	639.0	630.0	120	155	0.30
Red Orange	ASMC-PHB9-Txxx5	AllnGaP	623.0	617.0	120	263	0.29
Amber	ASMC-PAB9-Txxx5	AllnGaP	594.0	592.0	120	500	0.26

- The dominant wavelength, λ_D , is derived from the CIE Chromaticity Diagram and represents the color of the device.
- $\theta_{1/2}$ is the off-axis angle where the luminous intensity is 1/2 the peak intensity.
- Radiant intensity, I_e in watts/steradian, may be calculated from the equation $I_e = I_V/\eta_V$, where I_V is the luminous intensity in candelas and η_V is the luminous efficacy in lumens/watt.
- Φ_V is the total luminous flux output as measured with an integrating sphere at mono pulse conditions.

Electrical Characteristics ($T_J = 25\text{ }^\circ\text{C}$)

Part Number	Forward Voltage V_F (Volts) at $I_F = 50\text{ mA}$		Reverse Voltage V_R at $100\text{ }\mu\text{A}$
	Typ.	Max.	Min.
ASMC-PxB9-Txxx5	2.8	3.4	5

Figure 1: Relative Intensity vs. Wavelength

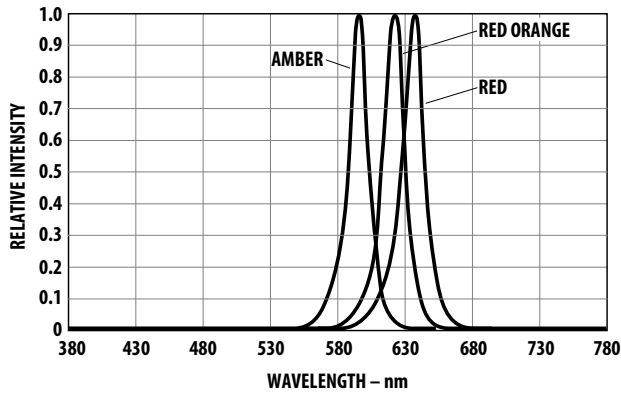

Figure 2: Forward Current vs. Forward Voltage

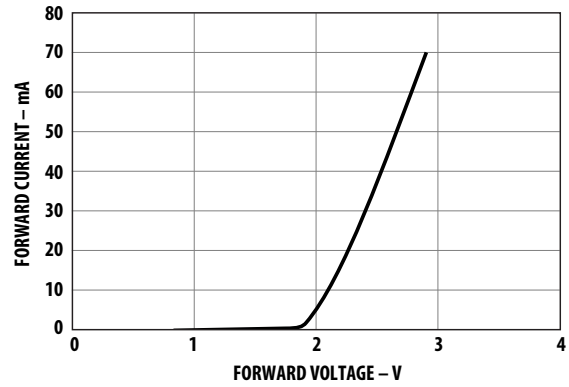

Figure 3: Relative Intensity vs. Forward Current

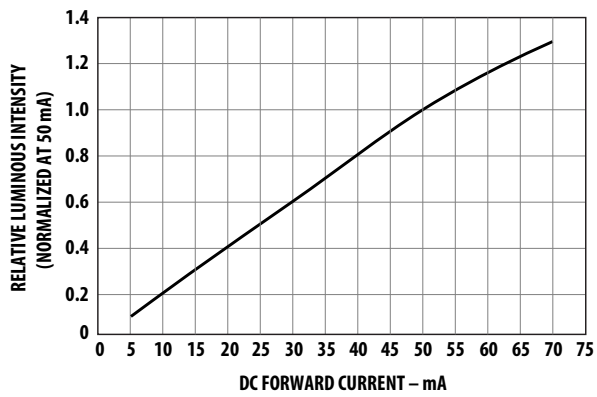

Figure 4: Maximum Forward Current vs. Ambient Temperature (Derated Based on $T_{JMAX} = 125^{\circ}C$, $R_{\theta JA} = 300^{\circ}C/W$)

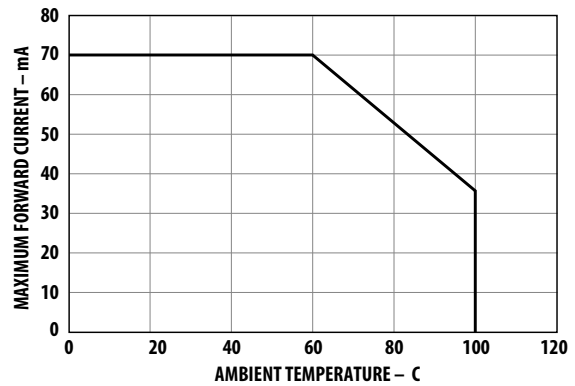

Figure 5: Radiation Pattern

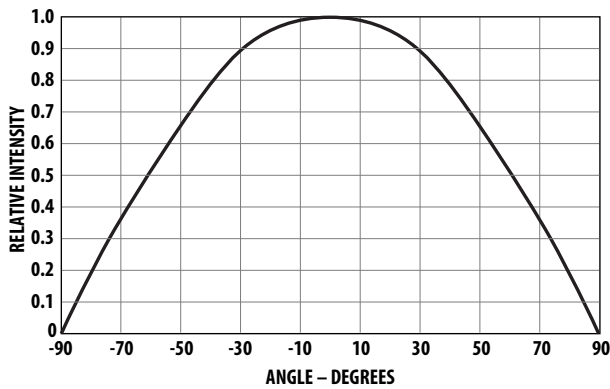

Figure 6: Recommended Sn-Pb Reflow Soldering Profile

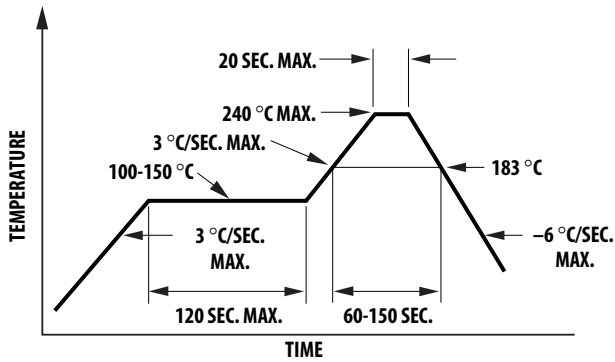
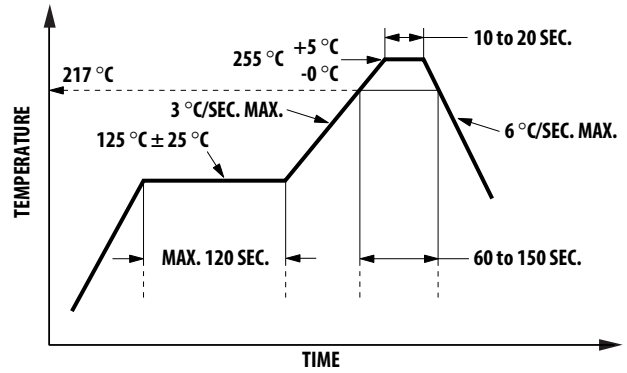

Figure 7: Recommended Pb-Free Reflow Soldering Profile



* THE TIME FROM 25 °C TO PEAK TEMPERATURE = 6 MINUTES MAX.

For detailed information on reflow soldering of Broadcom surface-mount LEDs, refer to Application Note AN 1060, *Surface Mounting SMD LED Indicator Components*.

Figure 8: Recommended Wave Soldering Profile

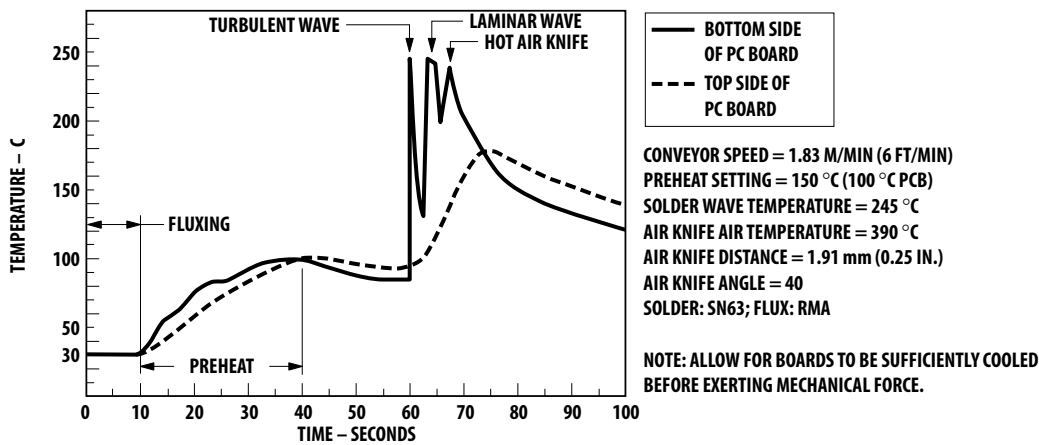

Figure 9: Recommended Soldering Pattern

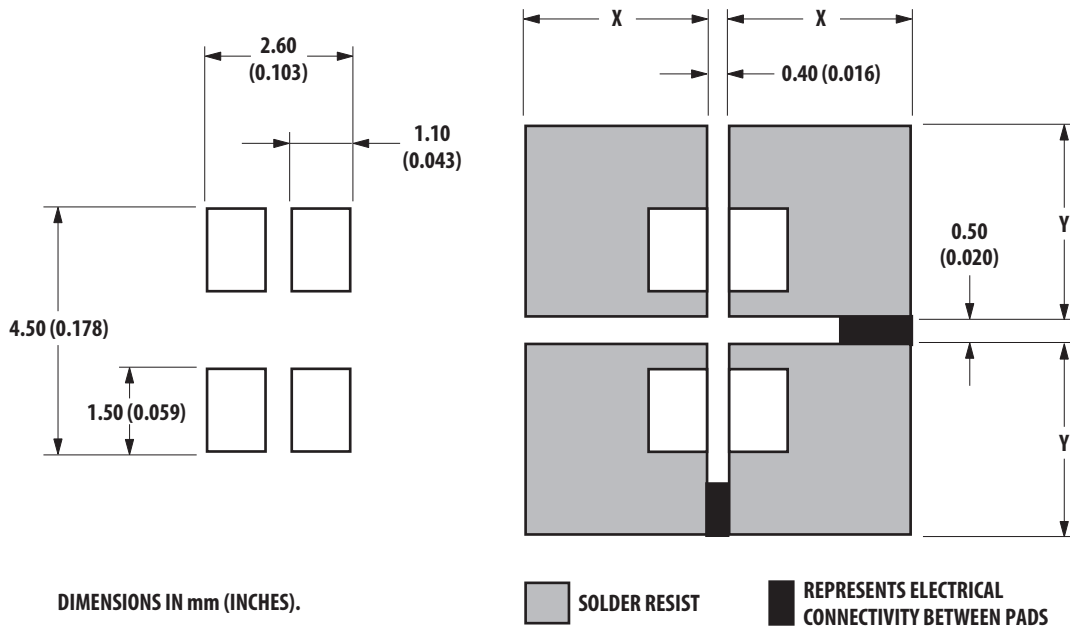
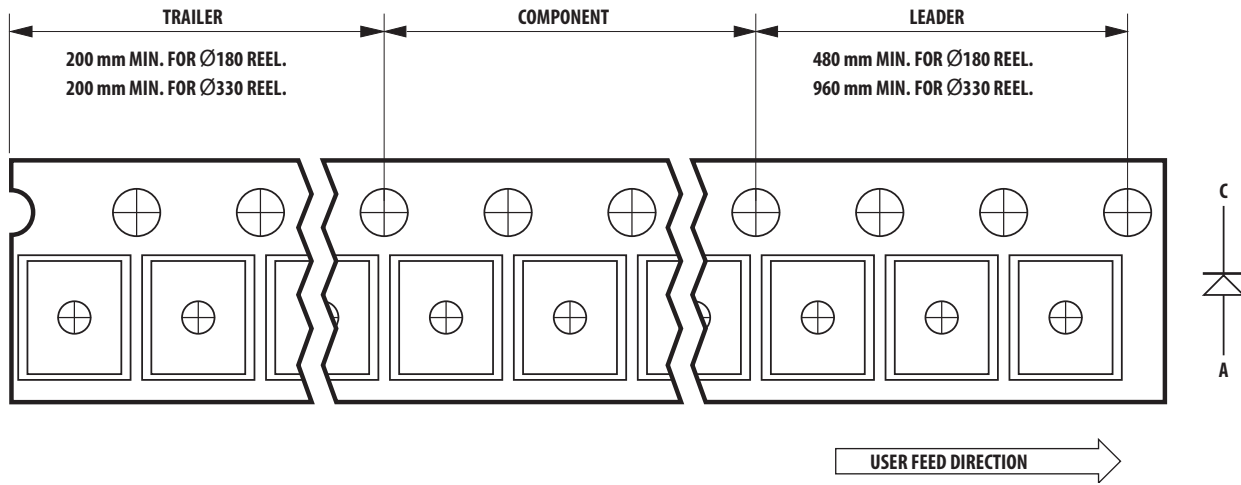

Figure 10: Tape Leader and Trailer Dimensions



Intensity Bin Select (X₂X₃)

Individual reel will contain parts from one half bin only.

X ₂	Min I _V Bin
X ₃	
0	Full Distribution
2	2 half bins starting from X ₂ 1
3	3 half bins starting from X ₂ 1
4	4 half bins starting from X ₂ 1
5	5 half bins starting from X ₂ 1
6	2 half bins starting from X ₂ 2
7	3 half bins starting from X ₂ 2
8	4 half bins starting from X ₂ 2
9	5 half bins starting from X ₂ 2

Intensity Bin Limits and Typical Flux

Bin ID	Min. (mcd)	Max. (mcd)
V1	715.00	900.00
V2	900.00	1125.00
W1	1125.00	1400.00
W2	1400.00	1800.00
X1	1800.00	2240.00
X2	2240.00	2850.00

Tolerance of each bin limit = ±12%.

Color Bin Select (X₄)

Individual reel will contain parts from one full bin only.

X ₄	
0	Full Distribution
A	1 and 2 only
B	2 and 3 only
C	3 and 4 only
D	4 and 5 only
E	5 and 6 only
G	1, 2, and 3 only
H	2, 3, and 4 only
J	3, 4, and 5 only
K	4, 5, and 6 only
M	1, 2, 3, and 4 only
N	2, 3, 4, and 5 only
P	3, 4, 5, and 6 only
R	1, 2, 3, 4, and 5 only
S	2, 3, 4, 5, and 6 only

Color Bin Limits

Amber/Yellow	Min. (nm)	Max. (nm)
1	582.0	584.5
2	584.5	587.0
3	587.0	589.5
4	589.5	592.0
5	592.0	594.5
6	594.5	597.0

Red Orange	Min. (nm)	Max. (nm)
1	611.0	616.0
2	616.0	620.0

Red	Min. (nm)	Max. (nm)
Full Distribution		

Tolerance of each bin limit = ±1 nm.

Packaging Option (X₅)

Option	Test Current	Package Type	Reel Size
5	50 mA	Top Mount	7 inch

Forward Voltage Bin Table for ASMC-PXB9-Txxxx Only

Bin	Min.	Max.
VA	1.9	2.2
VB	2.2	2.5
VC	2.5	2.8
VD	2.8	3.1
VE	3.1	3.4

Tolerance of each bin limit = ± 0.05 .

Precautionary Notes

Handling Precautions

The encapsulation material of the LED is made of silicone for better product reliability. Compared to epoxy encapsulant that is hard and brittle, silicone is softer and flexible. Special handling precautions must be observed during assembly of silicone encapsulated LED products. Failure to comply might lead to damage and premature failure of the LED. Refer to Application Note AN5288, *Silicone Encapsulation for LED: Advantages and Handling Precautions*, for more information.

- Do not poke sharp objects into the silicone encapsulant. Sharp objects, like tweezers or syringes, might apply excessive force or even pierce through the silicone and induce failures to the LED die or wire bond.
- Do not touch the silicone encapsulant. Uncontrolled force acting on the silicone encapsulant might result in excessive stress on the wire bond. Hold the LED only by the body.
- Do not stack assembled PCBs together. Use an appropriate rack to hold the PCBs.
- The surface of the silicone material attracts dust and dirt easier than epoxy due to its surface tackiness. To remove foreign particles on the surface of silicone, a cotton bud can be used with isopropyl alcohol (IPA). During cleaning, rub the surface gently without putting much pressure on the silicone. Ultrasonic cleaning is not recommended.

- For automated pick and place, Broadcom has tested the following nozzle size to be working with this LED. However, due to the possibility of variations in other parameters, such as pick and place machine maker/model and other settings of the machine, the customer should verify that the nozzle selected will not cause damage to the LED.

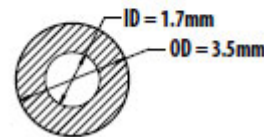
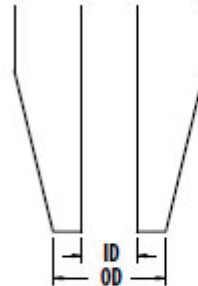

Handling of Moisture Sensitive Devices

This product has a Moisture Sensitive Level 3 rating per JEDEC J-STD-020. Refer to the Application Note AN5305, *Handling of Moisture Sensitive Surface Mount Devices*, for additional details and a review of proper handling procedures.

- Before use:
 - An unopened moisture barrier bag (MBB) can be stored at $< 40\text{ }^{\circ}\text{C}/90\%\text{ RH}$ for 12 months. If the actual shelf life has exceeded 12 months and the humidity indicator card (HIC) indicates that baking is not required, it is safe to reflow the LEDs per the original MSL rating.
 - Do not open the MBB prior to assembly (for example, for IQC).
- Control after opening the MBB:
 - Read the HIC immediately upon opening of MBB.
 - The LEDs must be kept at $< 30\text{ }^{\circ}\text{C} / 60\%\text{ RH}$ at all times and all high temperature-related processes, including soldering, curing, or rework, must be completed within 168 hours.
- Control for unfinished reel:
 - Store unused LEDs in a sealed MBB with desiccant or desiccator at $< 5\%\text{ RH}$.

- Control of assembled boards:
If the PCB soldered with the LEDs is to be subjected to other high temperature processes, the PCB must be stored in a sealed MBB with desiccant or desiccator at <5% RH to ensure that all LEDs have not exceeded their floor life of 168 hours.
- Baking is required if:
 - The HIC indicator is not BROWN at 10% and is AZURE at 5%.
 - The LEDs are exposed to condition of >30°C/60% RH at any time.
 - The LED floor life exceeded 168 hrs.
 The recommended baking condition is 60 ± 5°C for 20 hrs.
Baking should only be done once.
- Storage:
The soldering terminals of these Broadcom LEDs are silver plated. If the LEDs are exposed in ambient environment for too long, the silver plating might become oxidized, which affects its solderability performance. As such, keep unused LEDs in a sealed MBB with desiccant or in desiccator at <5% RH.

Application Precautions

- The drive current of the LED must not exceed the maximum allowable limit across temperature as stated in the data sheet. Constant current driving is recommended to ensure consistent performance.
- LEDs exhibit slightly different characteristics at different drive currents that might result in larger variations in their performance (that is, intensity, wavelength and forward voltage). Set the application current as close as possible to the test current to minimize these variations.
- The LED is not intended for reverse bias. Use other appropriate components for such purposes. When driving the LED in matrix form, ensure that the reverse bias voltage does not exceed the allowable limit of the LED.
- Do not use the LED in the vicinity of materials with sulfur content, such as environment of high gaseous sulfur compounds and corrosive elements. Examples of material that may contain sulfur are rubber gasket, RTV (room temperature vulcanizing) silicone rubber, rubber gloves, and so on. Prolonged exposure to such environments might affect the optical characteristics and product life.
- Avoid rapid change in ambient temperature, especially in high humidity environments because they will cause condensation on the LED.

- Although the LED is rated as IPx6 according to IEC60529: Degree of protection provided by enclosure, the test condition may not represent actual exposure during application. If the LED is intended to be used in outdoor or harsh environments, the LED must be protected against damages caused by rain water, dust, oil, corrosive gases, external mechanical stress and so on.

Thermal Management

Optical, electrical, and reliability characteristics of the LED are affected by temperature. Keep the junction temperature (T_J) of the LED below the allowable limit at all times. T_J can be calculated as below:

$$T_J = T_A + R_{\theta J-A} \times I_F \times V_{Fmax}$$

where:

T_A = ambient temperature (°C)

$R_{\theta J-A}$ = thermal resistance from LED junction to ambient (°C/W)

I_F = forward current (A)

V_{Fmax} = maximum forward voltage (V)

The complication of using this formula lies in T_A and $R_{\theta J-A}$. Actual T_A is sometimes subjective and hard to determine. $R_{\theta J-A}$ varies from system to system depending on design and is usually not known.

Another way of calculating T_J is by using solder point temperature T_S as follows:

$$T_J = T_S + R_{\theta J-S} \times I_F \times V_{Fmax}$$

where:

T_S = LED solder point temperature as shown in the following illustration (°C)

$R_{\theta J-S}$ = thermal resistance from junction to solder point (°C/W)

Source 1

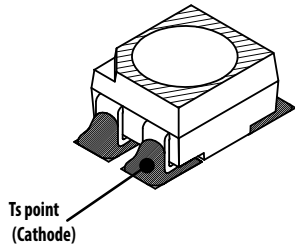

Source 2

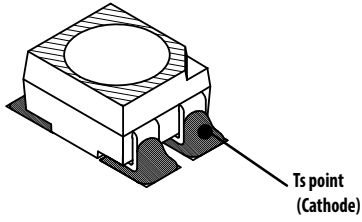

T_S can be measured easily by mounting a thermocouple on the soldering joint as shown in the preceding illustration, while $R_{\theta_{J-S}}$ is provided in the data sheet. Verify the T_S of the LEDs in the final product to ensure that the LEDs are operated within all maximum ratings stated in this data sheet.

Eye Safety Precautions

LEDs can pose optical hazards when in operation. Do not look directly at operating LEDs because doing so might be harmful to the eyes. For safety reasons, use appropriate shielding or personal protective equipment.

Disclaimer

Broadcom's products and software are not specifically designed, manufactured, or authorized for sale as parts, components, or assemblies for the planning, construction, maintenance, or direct operation of a nuclear facility or for use in medical devices or applications. The customer is solely responsible, and waives all rights to make claims against Broadcom or its suppliers, for all loss, damage, expense, or liability in connection with such use.

Broadcom, the pulse logo, Connecting everything, Avago Technologies, Avago, and the A logo are among the trademarks of Broadcom and/or its affiliates in the United States, certain other countries, and/or the EU.

Copyright © 2015–2018 Broadcom. All Rights Reserved.

The term “Broadcom” refers to Broadcom Inc. and/or its subsidiaries. For more information, please visit www.broadcom.com.

Broadcom reserves the right to make changes without further notice to any products or data herein to improve reliability, function, or design. Information furnished by Broadcom is believed to be accurate and reliable. However, Broadcom does not assume any liability arising out of the application or use of this information, nor the application or use of any product or circuit described herein, neither does it convey any license under its patent rights nor the rights of others.



Lead (Pb) Free
RoHS 6 fully
compliant