

1.5A 1.5MHz Synchronous Buck Converter

DESCRIPTION

The BL8027 is a high-efficiency monolithic synchronous buck regulator using a constant frequency, current mode architecture. The device is available in an adjustable version. Supply current with no load is 40uA and drops to <1uA in shutdown. The 2.5V to 6V input voltage range makes the BL8027 ideally suited for single Li-Ion battery powered applications. 100% duty cycle provides low dropout operation, extending battery life in portable systems. PWM/PFM mode operation provides very low output ripple voltage for noise sensitive applications.

Switching frequency is internally set at 1.5MHz, allowing the use of small surface mount inductors and capacitors. Low output voltages are easily supported with the 0.6V feedback reference voltage.

The BL8027 is available in SOT23-5 package.

FEATURES

- High Efficiency: Up to 96%
- 2.5V to 6V Input Voltage Range
- 1.5MHz Constant Frequency Operation
- No Schottky Diode Required
- Low Dropout Operation:100% Duty Cycle
- PFM Mode for High Efficiency in Light Load
- Over temperature Protected
- Low Quiescent Current: 40μA
- Short Circuit Protection
- Inrush Current Limit and Soft Start
- Available in SOT23-5

APPLICATIONS

- Cellular and Smart Phones
- Wireless and DSL Modems
- PDAs
- Portable Instruments
- Digital Still and Video Cameras
- PC Cards

TYPICAL APPLICATION

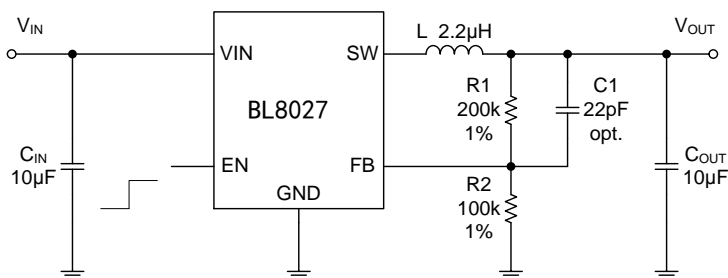

Note: C_{IN} and C_{OUT} recommended using ceramic capacitors. If the electrolytic capacitor is used, a capacitor of smaller ESR value needs to be selected.

PIN OUT & MARKING

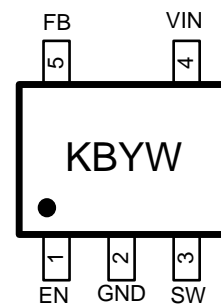

SOT23-5

KB: Product Code

YW: Date code (Year & Week)

ORDERING INFORMATION

PART No.	PACKAGE	Tape&Reel
BL8027CB5TR	SOT23-5	3000/Reel

ABSOLUTE MAXIMUM RATING

Parameter	Value
Max Input Voltage	8V
Max Voltage All Pins	8V
Max Operating Junction Temperature(Tj)	125°C
Ambient Temperature(Ta)	-40°C – 85°C
Maximum Power Dissipation	SOT23-5 400mW
Storage Temperature(Ts)	-40°C - 150°C
Lead Temperature & Time	260°C, 10S

Note: Exceed these limits to damage to the device. Exposure to absolute maximum rating conditions may affect device reliability.

ELECTRICAL CHARACTERISTICS

(Vin=VEN=3.6V, TA=25°C)

Symbol	Parameter	Conditions	Min	Typ	Max	Unit
Vin	Input Voltage Range		2.5		6	V
Vref	Feedback Voltage		0.588	0.6	0.612	V
Iq	Quiescent Current	V _{FB} =Vref* 90%, Vin=5.0V, Iload=0mA		150	300	uA
		V _{FB} =Vref*105%, Vin=5.0V, Iload=0mA		40	70	uA
		V _{EN} = 0V, Vin=4.2V		0.1	1.0	uA
LnReg	Line Regulation	Vin=2.5V to 6V		0.1	0.2	%/V
LdReg	Load Regulation			0.5		%
Fsoc	Switching Frequency			1.5		MHz
RdsonP	PMOS Rdson	I _{SW} =100mA		300		mohm
RdsonN	NMOS Rdson	I _{SW} =-100mA		200		mohm
Ilimit	Peak Current Limit	Vin=5V, Vout=3.3V		2.2		A
Inoload*		Vin=5V, Vout=3.3V, Iout=0		43		uA
Iswlk	SW Leakage Current	V _{EN} =0V, Vin=Vsw=5V			1	uA
Ienlk	EN Leakage Current				1	uA
Vh_en	EN Input High Voltage		1.04			V
VI_en	EN Input Low Voltage				0.98	V

Note: *When Duty cycle >90%, Inoload will increase. e.g. Vin=3.5V/Vout=3.3V, Inoload=800uA.

PIN DESCRIPTION

PIN #	NAME	DESCRIPTION
1	EN	Chip Enable Pin. Drive EN above 1.5V to turn on the part. Drive EN below 0.3V to turn it off. Do not leave EN floating.
2	GND	Ground
3	SW	Power Switch Output. It is the switch node connection to Inductor. This pin connects to the drains of the internal P-ch and N-ch MOSFET switches.
4	VIN	Supply voltage. Must be closely decoupled to GND with a 10μF or greater ceramic capacitor.
5	FB	Output Voltage Feedback Pin. An internal resistive divider divides the output voltage down for comparison to the internal reference voltage.

ELECTRICAL PERFORMANCE

Tested under $T_A=25^{\circ}\text{C}$, unless otherwise specified

Efficiency vs. Output Current
($V_{out}=1.2\text{V}$)

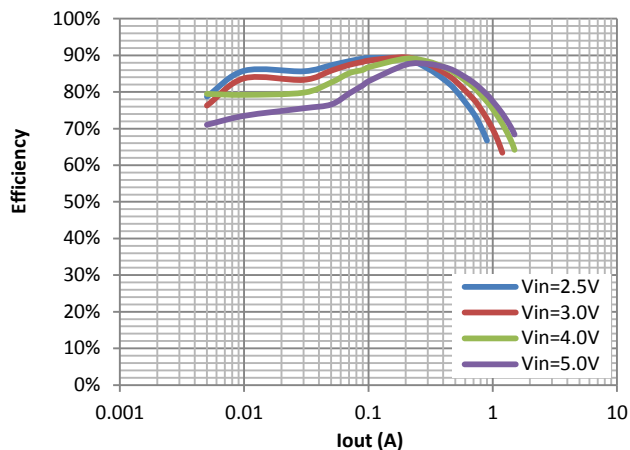

Efficiency vs. Output Current
($V_{out}=1.8\text{V}$)

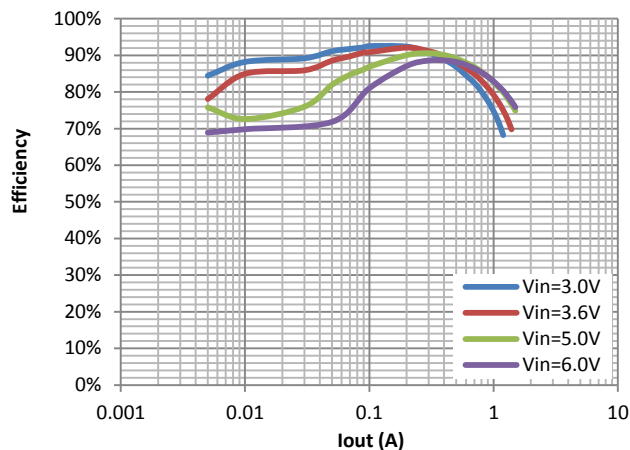

Efficiency vs. Output Current
($V_{out}=3.3\text{V}$)

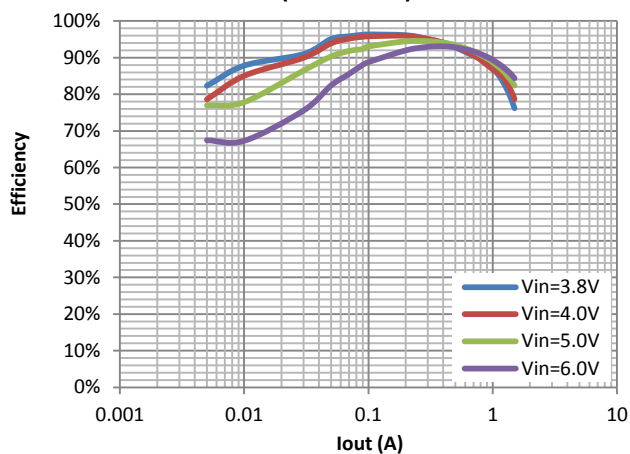

Output Ripple and SW at 1.5A load
 $V_{in}=5\text{V} / V_{out}=3.3\text{V}$

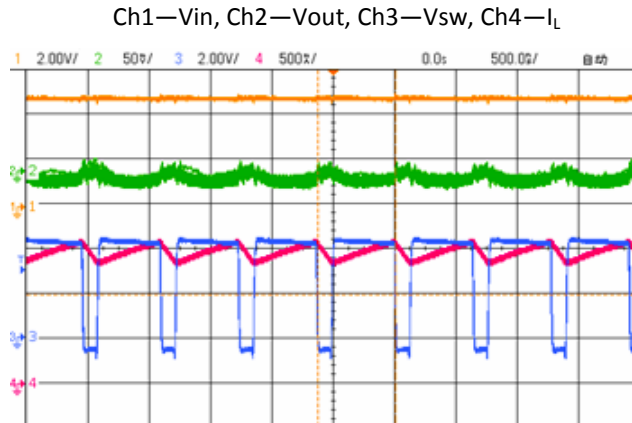

BLOCK DIAGRAM

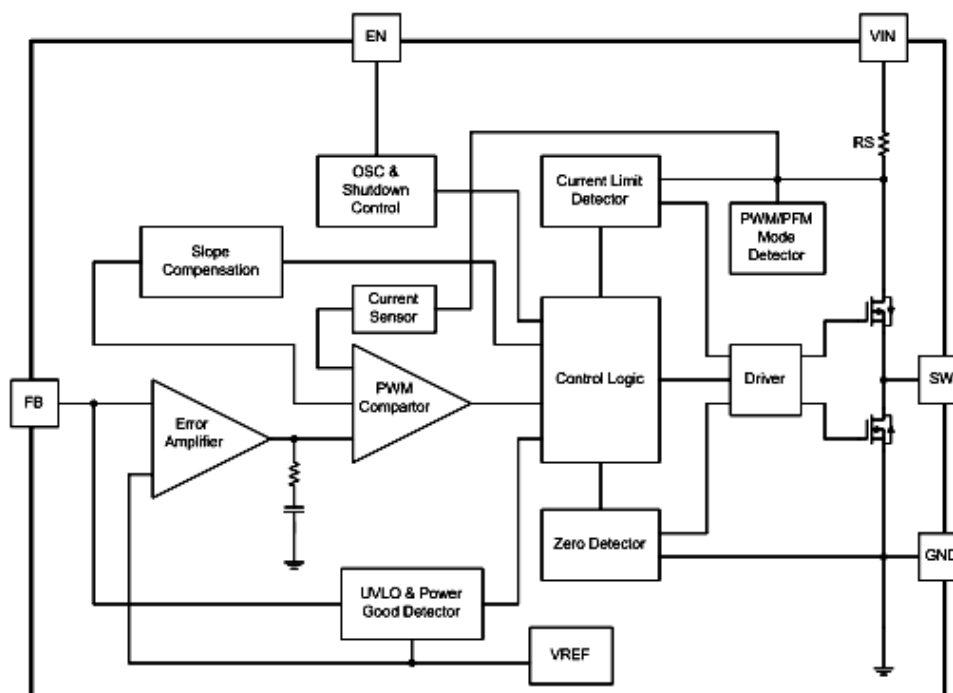

DETAILED DESCRIPTION

The BL8027 uses a constant frequency, current mode step-down architecture. Both the main (P-channel MOSFET) and synchronous (N-channel MOSFET) switches are internal. During normal operation, the internal top power MOSFET is turned on each cycle when the oscillator sets the RS latch, and turned off when the current comparator, ICOMP, resets the RS latch. The peak inductor current at which ICOMP resets the RS latch, is controlled by the output of error amplifier EA. When the load current increases, it causes a slight decrease in the feedback voltage, FB, relative to the 0.6V reference, which in turn, causes the EA amplifier's output voltage to increase until the average inductor current matches the new load current. While the top MOSFET is off, the bottom MOSFET is turned on until either the inductor current starts to reverse, as indicated by the current reversal comparator IRCMP, or the beginning of the next clock cycle.

APPLICATIONS INFORMATION

Setting the Output Voltage

In the adjustable version, the output voltage is set by a resistive divider according to the following formula:

$$R_2 = \frac{R_1}{V_{out} / V_{FB} - 1}$$

The external resistive divider is connected to the output, allowing remote voltage sensing as shown in on page 1 .

Inductor Selection

For most designs, the BL8027 operates with inductors of 1μH to 4.7μH. Low inductance values are physically smaller but require faster switching, which results in some efficiency loss. The inductor value can be derived from the following equation:

$$L = \frac{V_{OUT} \times (V_{IN} - V_{OUT})}{V_{IN} \times \Delta I_L \times f_{OSC}}$$

Where ΔI_L is inductor Ripple Current. Large value inductors result in lower ripple current and small value inductors result in high ripple current. For optimum voltage-positioning load transients, choose an inductor with DC series resistance in the 50mΩ to 150mΩ range.

Input Capacitor Selection

Higher values, lower cost ceramic capacitors are now becoming available in smaller case sizes. Their high ripple current, high voltage rating and low ESR make them ideal for switching regulator applications. Because the BL8027's control loop does not depend on the output capacitor's ESR for stable operation, ceramic capacitors can be used freely to achieve very low output ripple and small circuit size. However, care must be taken when ceramic capacitors are used at the input and the output. When a ceramic capacitor is used at the input and the power is supplied by a wall adapter through long wires, a load step at the output can induce ringing at the input, VIN. At best, this ringing can couple to the output and be mistaken as loop instability. At worst, a sudden inrush of current through the long wires can potentially cause a voltage spike at VIN, large enough to damage the part. When choosing the input and output ceramic capacitors, choose the X5R or X7R dielectric

formulations. These dielectrics have the best temperature and voltage characteristics of all the ceramics for a given value and size.

PC Board Layout Checklist

When laying out the printed circuit board, the following checking should be used to ensure proper operation of the BL8027. Check the following in your layout:

- 1) The power traces, consisting of the GND trace, the SW trace and the VIN trace should be kept short, direct and wide.
- 2) Does the (+) plates of Cin connect to Vin as closely as possible? This capacitor provides the AC current to the internal power MOSFETs.
- 3) Keep the switching node, SW, away from the sensitive VOUT node.
- 4) Keep the (-) plates of Cin and Cout as close as possible

PACKAGE OUTLINE

Package	SOT23-5	Devices per reel	3000	Unit	mm
Package specification:					
<p>The drawing shows the mechanical specifications for the SOT23-5 package. The top view shows a total width of 2.9 ± 0.2 mm and a distance between the two inner pins of 1.9 ± 0.2 mm, with each pin offset by 0.95 mm from the center. The bottom view shows a total width of 2.8 ± 0.3 mm and a distance between the two inner pins of 1.6 ± 0.1 mm. The side view shows a maximum height of 1.1 ± 0.2 mm, a distance from the top edge to the start of the lead of 0.8 ± 0.1 mm, and a lead thickness of 0.15 ± 0.1 mm. The lead length is 0.4 ± 0.1 mm. A minimum lead length of 0.2 mm is also indicated. The bottom view shows a distance of 0 to 0.1 mm from the bottom edge to the start of the lead.</p>					