

MACX MCR-EX-T-UIREL-UP...



Temperature transducers with intrinsically safe input for temperature sensors, voltage signals, resistance-type sensors and potentiometers

Data sheet
104602_en_06

© PHOENIX CONTACT 2014-07-10

1 Description

The configurable and programmable **MACX MCR-EX-T-UIREL-UP...** temperature transducer is used for the intrinsically safe (Ex i) operation of all standard temperature sensors (RTDs and thermocouples), voltage signals, remote resistance-type sensors and potentiometers. The temperature input signals are output in a linearized format at the output. In addition to an analog current and voltage output, the module also has three switching outputs. If you use the device in safety-related applications, relay 2 and 3 are connected to create a safety-related switching output. The power supply has been designed as a wide range power supply.

The devices can be installed in zone 2 in the protection type "n" (EN 60079-15).

Features such as sensor type, connection method, measuring range, measuring unit, filter, alarm signal and output range can be configured using the ANALOG-CONF software and a device-specific DTM (Device Type Manager).

Features

- Input for all standard temperature sensors (RTDs and thermocouples), voltage signals, remote resistance-type sensors and potentiometers.
- With intrinsically safe inputs [Ex ia] IIC
- Current and voltage output
- Switching output (3 PDT relay)
- Switching output SIL: 1 relay
- Configuration via software (FDT/DTM, ANALOG-CONF) or operator interface (IFS-OP-UNIT)
- Up to SIL 2 according to EN 61508 on output 4 ... 20 mA
- 3-way electrical isolation
- Installation in zone 2 permitted
- Wide range power supply 19.2 ... 253 V AC/DC
- With screw or spring-cage connection (push-in technology)



WARNING: Explosion hazard

The device is an item of associated electrical equipment for intrinsically safe circuits. It is designed for use in zone 2, if specific conditions are observed.

When installing and operating the device, the applicable safety directives (including national safety directives), accident prevention regulations, as well as general technical regulations must be observed.



WARNING: Explosion hazard

Please observe the safety regulations and installation notes on page 8.



Make sure you always use the latest documentation.
It can be downloaded at phoenixcontact.net/products.



This data sheet is valid for the products listed in section 3 "Ordering data".

2 Table of contents

1	Description.....	1
2	Table of contents	2
3	Ordering data.....	5
4	Technical data	6
5	Safety regulations and installation notes.....	8
5.1	Installation notes	8
5.2	Intrinsic safety.....	8
5.3	Installation in Zone 2	8
5.4	Potentially dust-explosive areas	8
5.5	UL notes	8
5.6	Use in safety-related applications (SIL 2).....	8
6	Sensor types	9
6.1	Thermocouple (TC) with internal cold junction compensation	10
6.2	Thermocouple (TC) with external or without cold junction compensation	10
6.3	Voltage input.....	10
6.4	Potentiometer	10
6.5	Resistance thermometer (RTD)	10
6.6	Measuring resistances	10
7	Minimum span and measuring accuracies	11
7.1	Pt and Ni-RTD inputs.....	11
7.2	Cu-RTD inputs.....	11
7.3	NI1000 input (Landis & Gyr), KTY 81-110, KTY 84-130 (Philips)	11
7.4	Thermocouple input.....	11
7.5	Cold junction error.....	11
7.6	Voltage signal input	11
7.7	R transducers and resistors	11
7.8	Potentiometer	12
7.9	Output signals	12
8	Installation	13
8.1	Basic circuit diagrams	13
8.2	Structure.....	14
8.3	Dimensions	14
8.4	Mounting	14
8.5	Connecting the cables	15
8.6	Power supply	15

8.7	Current output	15
8.8	Voltage output	15
8.9	Switching output.....	16
8.10	Switching output behavior with manual acknowledgement (latching)	17
8.10.1	Switching behavior (2): Undertemperature limit (\leq SPH)	17
8.10.2	(Switching behavior (3): Overtemperature limit (\geq SPH)	17
8.10.3	Switching behavior (4): Undertemperature limit with hysteresis (\leq SPL)	18
8.10.4	Switching behavior (5): Overtemperature limit with hysteresis (\geq SPH).....	18
8.10.5	Switching behavior (6): Temperature range limit (\leq SPL and \geq SPH)	19
8.10.6	Switching behavior (7): Temperature range limit (\geq SPL and \leq SPH)	19
8.11	Connection of relay contacts.....	20
8.12	Monitoring function	21
8.13	Operating modes	21
8.13.1	SIL ON/SIL OFF	21
8.13.2	Service mode	21
9	Configuration	21
9.1	Delivered state/standard configuration.....	22
9.2	Zero adjust, adjustment via buttons S2 and S3 (only possible with SIL OFF)	22
9.3	Span adjust, adjustment via buttons 2 and 4 (only possible with SIL OFF).....	22
9.4	Force output.....	22
9.5	Cable compensation, 2-wire RTD or RTD 1 with 2 x RTD	22
9.6	Cable compensation RTD 2 with 2 x RTD or TC with external cold junction compensation (TC + CJ external)	22
9.7	Automatic potentiometer adjustment (teach-in)	23
9.8	Manual acknowledgement of switching outputs (latch function).....	23
9.9	LED status indicators	23
10	Password.....	24
11	Configuration with the service PC.....	24
11.1	System requirements	24
11.2	Configuring the user characteristic curve	25
12	Comparison of safety data	25
13	Connection examples	26
13.1	Current output	26
13.2	Voltage output.....	27
13.3	Switching output.....	27
14	Flow chart, operator interface	28
14.1	Menu structure	29
14.2	Key for start screen.....	30

14.3	Key for MENU.....	30
14.4	Key for SETTINGS - Configure	30
14.5	Key for SETTINGS - Service.....	30
14.6	Key for SETTINGS - Save	31
14.7	Key for input.....	32
14.7.1	Key for input configuration (analog input)	32
14.8	Key for output	35
14.8.1	Key for output configuration (analog output).....	35
14.9	Key for error handling.....	36
14.10	Key for switch	36
14.10.1	Key for switch 1	36
14.10.2	Key for switch 2	36
14.10.3	Key for switch 3 (only configurable with SIL OFF).....	37
15	IFS-OP-UNIT operator interface error codes	37
Appendix		
	Safety-related applications (SIL 2)	A-1

3 Ordering data

Temperature transducer, Ex i

Description	Type	Order No.	Pcs. / Pkt.
Standard configuration/in-stock article, with screw connection	MACX MCR-EX-T-UIREL-UP	2865751	1
Standard configuration/in-stock article, with spring-cage connection	MACX MCR-EX-T-UIREL-UP-SP	2924799	1

Accessories

Description	Type	Order No.	Pcs. / Pkt.
Operator interface for the configuration of compatible MACX modules.	IFS-OP-UNIT	2811899	1
Cradle unit, for snapping the operating and display unit onto the DIN rail	IFS-OP-CRADLE	2811886	1
Programming adapter for MACX MCR... devices. With USB interface for programming with the ANALOG-CONF software	IFS-USB-PROG-ADAPTER	2811271	1
Cold junction compensation connector for thermocouples	MACX MCR-EX-CJC	2925002	1



For additional accessories, please refer to the Interface technology and switching devices catalog from Phoenix Contact.

4 Technical data

Input

Resistance thermometer	Pt, Ni, Cu sensors: 2-, 3-, 4-wire
Thermocouple sensor	B, E, J, K, N, R, S, T, L, U, CA, DA, A1G, A2G, A3G, MG, LG (see example, "Sensor types" on page 9)
Resistors	0 Ω ... 50 kΩ
Potentiometer	0 Ω ... 50 kΩ
Voltage	-1000 mV ... 1000 mV

Output

Output signal	4 mA ... 20 mA with SIL ON (further output signals can be configured with SIL OFF)
Maximum output signal	
Voltage output	±11 V
Current output	22 mA
Load	
Voltage output	≥ 10 kΩ
Current output	≤ 600 Ω (at 20 mA)
Behavior in the event of a sensor error	According to NE 43 (or freely definable)

Switching outputs

Contact type	3 PDT contacts For SIL: 1 safety-related relay, 1 non safety-related PDT contact
Contact material	AgSnO ₂ , hard gold-plated
Maximum switching voltage	250 AC (250 V DC)
Maximum switching current	2 A (250 V AC) , 2 A (28 V DC)
Cycles	
With ohmic load	1 x 10 ⁵

General data

Supply voltage range	24 V ... 230 V AC/DC (-20%/+10%, 50/60 Hz)
Current consumption	< 100 mA (24 V DC)
Power consumption	< 2.4 W
Temperature coefficient	0.01 %/K, maximum
Step response (0 ... 99 %)	
With SIL	Typ. 1000 ms
Without SIL	Typ. 700 ms
Transmission error, total	< 0.1% (e.g., for Pt 100, 300 K span, 4 ... 20 mA)
Electrical isolation	4-way, between input/output/power supply/switching output
Input/output	375 V P (according to EN 60079-11)
Input/power supply	375 V P (according to EN 60079-11)
Input/switching output	375 V P (according to EN 60079-11)
Output/power supply	300 V rms reinforced insulation (according to EN 61010/50178)
Power supply/switching output	300 V rms reinforced insulation (according to EN 61010/50178)
Ambient temperature	
Operation	-20 °C ... +65 °C
Storage/transport	-40 °C ... +85 °C
Permissible humidity (operation)	5 % ... 95% (no condensation)
Shock	15g, IEC 60068-2-27
Vibration	5g, IEC 60068-2-6

General data [...]

Status indicators	Green LED (supply voltage, PWR) Red LED, flashing (cable error, sensor error, ERR) Red LED (module error, ERR) Yellow LED (switching output)
Housing material	PA 66-FR
Color	Green
Degree of protection	IP20
Pollution degree	2
Dimensions (width x height x depth)	35 x 99 x 114.5 mm
Inflammability class according to UL 94	V0
Design	Terminal housing for mounting on DIN rails

Conformance

EMC directive 2004/108/EC	EN 61326-1; EN 61000-6-2 ¹ ; EN 61000-6-4
Ex directive (ATEX)	EN 60079-0, EN 60079-11, EN 60079-15, EN 61241-0, EN 61241-11

¹ During the interference, there can possibly be small deviations.

Safety data according to ATEX for intrinsically safe circuits

Maximum voltage (U _o)	6 V					
Maximum current (I _o)	7.4 mA					
Maximum power (P _o)	11 mW					
Gas group	Ex ia II C			Ex ia II B		
Maximum external inductance (L _o)	100 mH	10 mH	1 mH	100 mH	10 mH	1 mH
Maximum external capacity (C _o)	1.3 µF	1.7 µF	2.6 µF	6.8 µF	9.2 µF	15 µF
Maximum internal inductance (C _i)	44 nF	44 nF	44 nF	44 nF	44 nF	44 nF
Maximum internal inductance (L _i)	Negligible					
Maximum voltage U _m	253 V AC (125 V DC)					

Approvals

ATEX	⊕ II (1) G [Ex ia Ga] IIC; ⊕ II (1) D [Ex ia Da] IIIC; ⊕ II 3 G Ex nA nC ic IIC T4 Gc X	IBExU 10 ATEX 1044
IECEx approval	[Ex ia Ga] IIC; [Ex ia Da] IIIC; Ex nA nC ic IIC T4 Gc X	IECEx IBE 10.0004X
UL, USA/Canada	UL, C.D.-No 83104549	
Functional safety (SIL)	UL 508 Listed Can be used up to SIL 2	

Connection data MACX MCR-EX-T-UIREL-UP

Conductor cross section	
Solid (minimum/maximum)	0.2 mm ² /2.5 mm ²
Stranded (minimum/maximum)	0.2 mm ² /2.5 mm ²
AWG (minimum/maximum)	24/14
Stripping length	7 mm
Connection method	Plug-in screw connection
Tightening torque	Minimum 0.5 Nm/maximum 0.6 Nm

Connection data MACX MCR-EX-T-UIREL-UP-SP

Conductor cross section	
Solid (minimum/maximum)	0.2 mm ² /1.5 mm ²
Stranded (minimum/maximum)	0.2 mm ² /1.5 mm ²
AWG (minimum/maximum)	24/16
Stripping length	8 mm
Connection method	Spring-cage connection

5 Safety regulations and installation notes

5.1 Installation notes

- The device is a piece of equipment (category 1) which belongs to the "Intrinsic Safety" ignition protection class and can be installed in Ex zone 2 as a category 3 device. It meets the requirements of EN 60079-0:2012, EN 60079-11:2012, EN 60079-15:2010, IEC 60079-0 ed. 6.0, IEC 60079-11 ed. 6.0, and IEC 60079-15 ed. 4.0.
- Installation, operation, and maintenance may only be carried out by qualified electricians. Follow the installation instructions as described. When installing and operating the device, the applicable regulations and safety directives (including national safety directives), as well as general technical regulations, must be observed. For the safety technology data, see this packing slip and the certificates (EC examination certificate and other approvals if appropriate).
- The device must not be opened or modified. Do not repair the device yourself, replace it with an equivalent device. Repairs may only be carried out by the manufacturer. The manufacturer is not liable for damage resulting from violation.
- The IP20 protection (IEC 60529/EN 60529) of the device is intended for use in a clean and dry environment. The device must not be subject to mechanical strain and/or thermal loads, which exceed the limits described.
- The device complies with the EMC regulations for industrial areas (EMC class A). When using the device in residential areas, it may cause radio interference.
- Only specified devices from Phoenix Contact may be connected to the 12-pos. S-PORT interface.

5.2 Intrinsic safety

- The device is approved for intrinsically safe (Ex-i) circuits up to Ex zone 0 (gas) and Ex zone 20 (dust). The safety technology values for intrinsically safe equipment and the connecting lines must be observed for the hook-up process (IEC/EC 60079-14) and the values specified in this installation note and/or the EC examination certificate must be observed.
- When carrying out measurements on the intrinsically safe side, observe the relevant regulations regarding the connection of intrinsically safe equipment. Use only these approved measuring devices in intrinsically safe circuits.
- If the device was used in circuits which are not intrinsically safe, it is forbidden to use it again in intrinsically safe circuits. Label the device clearly as being not intrinsically safe.

5.3 Installation in Zone 2

- Observe the specified conditions for use in potentially explosive areas! Install the device in a suitable approved housing with a minimum of IP54 protection) that meets the requirements of EN 60079-15. Observe the requirements of EN 60079-14.
- Only devices which are designed for operation in Ex zone 2 and are suitable for the conditions at the installation location may be connected to the circuits in the Ex zone.
- Connecting and disconnecting cables in zone 2 is permissible only when the power is switched off.
- The device must be stopped and immediately removed from the Ex area if it is damaged, was subject to an impermissible load, stored incorrectly or if it malfunctions.

5.4 Potentially dust-explosive areas

- The device is not suitable for installation in zone 22.
- If you nevertheless intend to use the device in Zone 22, you must install it in a housing according to IEC/EN 60079-31. Observe the maximum surface temperatures in this case. Adhere to the requirements of IEC/EN 60079-14.
- Only make the connection to the intrinsically safe circuit in potentially dust-explosive areas of zones 20, 21 and 22 if the equipment connected to this circuit is certified for this zone (e.g., category 1D, 2D or 3D).

5.5 UL notes

Safety regulations related to the UL approval are contained in the "Control Drawing". The "Control Drawing" is part of the package slip.

5.6 Use in safety-related applications (SIL 2)

When using the MACX MCR-EX-T-UIREL-UP... in safety-related applications, observe the instructions in the appendix, as the requirements differ for safety-related functions.



Switching output 1 is not intended for safety-related applications.

In safety-related applications (SIL), switching outputs 2 and 3 must be combined according to the requirements of the application (see "Connection examples" on page 26).

The configuration of switching output 2 is also applied to switching output 3. In SIL ON mode, switching output 3 cannot be configured separately.

6 Sensor types

Description	Sensor type	Measuring range		Measuring unit	Smallest measuring range span
		Start	End		
Resistance thermometers (RTD) Others can be selected or freely configured in the software.	Pt 100 acc. to IEC/EN 60751	-200	850	°C	20 K
	Pt 200 acc. to IEC/EN 60751	-200	850	°C	20 K
	Pt 500 acc. to IEC/EN 60751	-200	850	°C	20 K
	Pt 1000 acc. to IEC/EN 60751	-200	850	°C	20 K
	Pt 100 acc. to Sama RC21-4-1966	-200	850	°C	20 K
	Pt 1000 acc. to Sama RC21-4-1966	-200	850	°C	20 K
	Pt 100 acc. to GOST 6651	-200	850	°C	20 K
	Pt 1000 acc. to GOST 6651	-200	850	°C	20 K
	Pt 100 acc. to JIS C1604/1997	-200	850	°C	20 K
	Pt 1000 acc. to JIS C1604/1997	-200	850	°C	20 K
	Ni 100 acc. to DIN 43760/DIN IEC 60751	-60	250	°C	20 K
	Ni 1000 acc. to DIN 43760/DIN IEC 60751	-60	250	°C	20 K
	Ni 100 acc. to Sama RC21-4-1966	-60	180	°C	20 K
	Ni 1000 acc. to Sama RC21-4-1966	-60	180	°C	20 K
	Ni 1000 (Landis & Gyr)	-50	160	°C	20 K
	Cu 10 acc. to Sama RC21-4-1966	-70	500	°C	100 K
	Cu 50/Cu 100 acc. to GOST 6651 ($\alpha = 1.428$)	-50	200	°C	100 K
	Cu 53 acc. to GOST 6651 ($\alpha = 1.426$)	-50	180	°C	100 K
	KTY81-110 (Philips)	-55	150	°C	20 K
	KTY84-130 (Philips)	-40	300	°C	20 K
Thermocouples (TC) Others can be selected in the software.	B acc. to IEC/EN 60584 (Pt30Rh-Pt6Rh)	500	1820	°C	50 K
	E acc. to IEC/EN 60584 (NiCr-CuNi)	-230	1000	°C	50 K
	J acc. to IEC/EN 60584 (Fe-CuNi)	-210	1200	°C	50 K
	K acc. to IEC/EN 60584 (NiCr-Ni)	-250	1372	°C	50 K
	N acc. to IEC/EN 60584 (NiCrSi-NiSi)	-250	1300	°C	50 K
	R acc. to IEC/EN 60584 (Pt13Rh-Pt)	-50	1768	°C	50 K
	S acc. to IEC/EN 60584 (Pt10Rh-Pt)	-50	1768	°C	50 K
	T acc. to IEC/EN 60584 (Cu-CuNi)	-200	400	°C	50 K
	L acc. to DIN 43760 (Fe-CuNi)	-200	900	°C	50 K
	U acc. to DIN 43760 (Cu-CuNi)	-200	600	°C	50 K
	CA C ASTM JE988 (2002)	0	2315	°C	50 K
	DA D ASTM JE988 (2002)	0	2315	°C	50 K
	A1G A-1 GOST 8.585-2001	0	2500	°C	50 K
	A2G A-2 GOST 8.585-2001	0	1800	°C	50 K
	A3G A-3 GOST 8.585-2001	0	1800	°C	50 K
	MG M GOST 8.585-2001	-200	100	°C	50 K
LG L GOST 8.585-2001	-200	800	°C	50 K	
Remote resistance-type sensors (R) (2, 3, 4-wire) Other areas can be selected in the software.	Resistance 0...50000 Ω	0	50000	Ω	10% of the selected measuring range
Potentiometers (3-wire) Other areas can be selected in the software.	Potentiometer: 0...50000 Ω	0	100	%	10% of the selected measuring range

Description	Sensor type	Measuring range		Measuring unit	Smallest measuring range span
		Start	End		
Voltage signals (mV) Others can be selected in the software.	Voltage (mV)	-1000	+1000	mV	10% of nominal span
Temperature conversion guide for °C to °F:		$T [^{\circ}\text{F}] = \frac{9}{5} T [^{\circ}\text{C}] + 32$			
Other setting options can be configured with the ANALOG-CONF software, e.g., a freely configurable user characteristic curve with 30 interpolation points.					

Depending on the connection method, the following terminal points are to be connected for temperature measurement (see Figure 1 on page 13):

6.1 Thermocouple (TC) with internal cold junction compensation

- Thermocouple connection: Terminals 4.1 “+”, 4.2 “-“



Use the MACX MCR-EX-CJC cold junction compensation connector provided (Order No. 2925002).



TC+CJ: Use the cold junction compensation connector provided at connection terminal blocks 4.1, 4.2 and 4.3.

6.2 Thermocouple (TC) with external or without cold junction compensation

- Thermocouple connection: Terminals 5.1 “+”, 5.2 “-“



TC+CJ external: Use the external cold junction sensor (e.g., PT100) at connection terminal blocks 4.2 and 4.3.

6.3 Voltage input

- Connection for $U \leq \pm 1000$ mV: Terminals 5.1 “+”, 5.2 “-“

6.4 Potentiometer

- Connection: Terminals 4.1, 4.2, 4.3

6.5 Resistance thermometer (RTD)



$R_L \leq 25 \Omega$ for each lead.

- 2-wire connection method: Terminals 4.2, 4.3
The cable resistance can be compensated with the help of the ANALOG-CONF PC program, the IFS-OP-UNIT operator interface or in service mode (DIP switch).
- 3-wire connection method: Terminals 4.1, 4.2, 4.3
In the case of the 3-wire connection method, ensure that all three cable resistances are the same.
- 4-wire connection method: Terminals 4.2, 4.3, 5.1, 5.2
- 2 x 2-wire connection method
Terminals RTD 1: 4.2, 4.3
Terminals RTD 2: 5.1, 5.2

6.6 Measuring resistances



Up to 75 Ω : $R_L \leq 2.5 \Omega$ for each lead.
Up to 150 Ω : $R_L \leq 5 \Omega$ for each lead.
Up to 300 Ω : $R_L \leq 10 \Omega$ for each lead.

The terminal points 4.2 and 4.3 are used for measuring differing resistances.

7 Minimum span and measuring accuracies

7.1 Pt and Ni-RTD inputs

Minimum measuring span:
 With $10 \Omega \leq R_0 < 100 \Omega$: 100 K
 With $100 \Omega \leq R_0 \leq 10 \text{ k}\Omega$: 20 K

Measuring accuracy:

For $10 \Omega \leq R_0 < 100 \Omega$: **0.2 K x 100 Ω / R₀**
 = 0.1% x (100 Ω /R₀) x (200 K/measuring span)

For $100 \Omega \leq R_0 \leq 1 \text{ k}\Omega$: **0.2 K**
 = 0.1% x (200 K/measuring span)

For $1 \text{ k}\Omega < R_0 \leq 10 \text{ k}\Omega$: **0.4 K**
 = 0.1% x (400 K/measuring span)

7.2 Cu-RTD inputs

Minimum measuring span:
 For $10 \Omega \leq R_0 < 100 \Omega$: 100 K
 For $100 \Omega \leq R_0 \leq 10 \text{ k}\Omega$: 20 K

Measuring accuracy:

For $10 \Omega \leq R_0 < 100 \Omega$: **0.5 K x 100 Ω /R₀**
 = 0.1% x (100 Ω /R₀) x (500 K/measuring span)

For $100 \Omega \leq R_0 \leq 1 \text{ k}\Omega$: **0.5 K**
 = 0.1% x (500 K/measuring span)

For $1 \text{ k}\Omega < R_0 \leq 10 \text{ k}\Omega$: **1.0 K**
 = 0.1% x (1000 K/measuring span)

7.3 NI1000 input (Landis & Gyr), KTY 81-110, KTY 84-130 (Philips)

Minimum measuring span: 20 K
 Measuring accuracy: 0.2 K

7.4 Thermocouple input

Minimum measuring span with TC: 50 K
 Measuring accuracy of the input with TC signals:
 TC type E, J, K, N, T, L, U, M, Lr
 Without cold junction error: 0.30 K
 TC types B, R, S, C, D, A1, A2, A3
 Without cold junction error: 0.50 K

7.5 Cold junction error

Cold junction error: $\pm 1 \text{ K}$, maximum
 (with internal cold junction compensation).
 With external compensation it depends on the quality of the cold junction and the sensor used.

7.6 Voltage signal input

Minimum measuring span:
 10% of the nominal span of the respective range.

Measuring accuracy:

-1000 ... 1000 mV : 0.01% (of measuring range)
 -500 ... 500 mV : 0.01% (of measuring range)
 -250 ... 250 mV : 0.01% (of measuring range)
 -125 ... 125 mV : 0.01% (of measuring range)
 -60 ... 60 mV : 0.01% (of measuring range)
 -30 ... 30 mV : 0.01% (of measuring range)
 -15 ... 15 mV : 0.01% (of measuring range)

7.7 R transducers and resistors

50% of measuring range \leq (nominal value of R transducer + lead resistance) \leq measuring range

Minimum measuring span: 10% of the selected measuring range

Measuring accuracy:

0 ... 75 Ω : 0.10% (of measuring range)
 0 ... 150 Ω : 0.05% (of measuring range)
 0 ... 300 Ω : 0.02% (of measuring range)
 0 ... 600 Ω : 0.01% (of measuring range)
 0 ... 1200 Ω : 0.01% (of measuring range)
 0 ... 2400 Ω : 0.01% (of measuring range)
 0 ... 4800 Ω : 0.01% (of measuring range)
 0 ... 6250 Ω : 0.02% (of measuring range)
 0 ... 12500 Ω : 0.02% (of measuring range)
 0 ... 25000 Ω : 0.02% (of measuring range)
 0 ... 50000 Ω : 0.02% (of measuring range)

Example:

R transducer with nominal value: 1000 Ω

Measuring range to be selected: 0 ... 1200 Ω

Minimum measuring span: 10% of the selected measuring range = 120 Ω

Measuring accuracy: 0.01% of the selected measuring range = 120 m Ω

7.8 Potentiometer

50% of measuring range \leq (nominal value of potentiometer + lead resistance) \leq measuring range

Minimum measuring span: 10% of the selected measuring range

Measuring accuracy:

0 ...	75 Ω	: 0.10%	(of measuring range)
0 ...	150 Ω	: 0.05%	(of measuring range)
0 ...	300 Ω	: 0.02%	(of measuring range)
0 ...	600 Ω	: 0.02%	(of measuring range)
0 ...	1200 Ω	: 0.02%	(of measuring range)
0 ...	2400 Ω	: 0.02%	(of measuring range)
0 ...	4800 Ω	: 0.02%	(of measuring range)
0 ...	6250 Ω	: 0.10%	(of measuring range)
0 ...	12500 Ω	: 0.10%	(of measuring range)
0 ...	25000 Ω	: 0.10%	(of measuring range)
0 ...	50000 Ω	: 0.10%	(of measuring range)

Example:

Potentiometer with nominal value: 1000 Ω

Measuring range to be selected: 0 ... 1200 Ω

Minimum measuring span: 10% of the selected measuring range = 120 Ω

Measuring accuracy: 0.02% of the selected measuring range = 240 m Ω

7.9 Output signals

Analog output error

2 mV	0.01% at -10 ... 10 V
2 mV	0.02% at 0 ... 10 V
4 μ A	0.02% at 0 ... 20 mA

8 Installation



NOTE: Electrostatic discharge!
 The device contains components that can be damaged or destroyed by electrostatic discharge. When handling the device, observe the necessary safety precautions against electrostatic discharge (ESD) according to EN 61340-5-1 and EN 61340-5-2.
 Take precautions against electrostatic discharge before opening the front cover.

8.1 Basic circuit diagrams

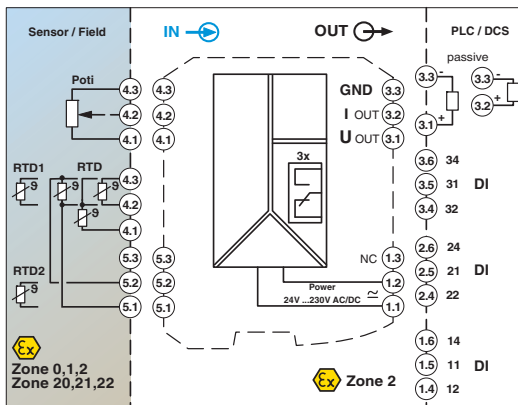

Figure 1 Sensor connection - resistance thermometers and potentiometers

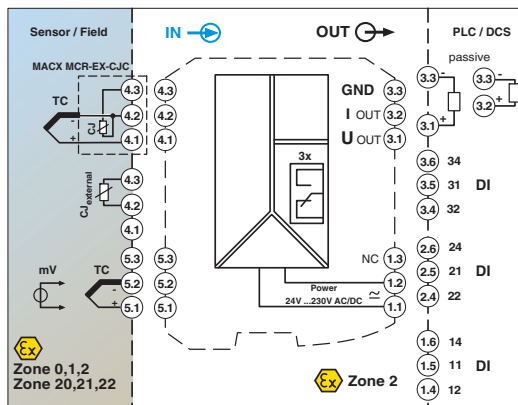

Figure 2 Sensor connection - thermocouples and mV sources

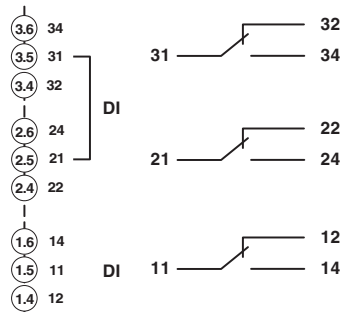

Figure 3 Terminal designations of the PDTs



Information for safety-related applications (SIL/PL):
 You have to jumper the relays in parallel for a normally-closed contact (see "Connection example 2:" on page 26).
 You have to jumper the relays in series for a normally-open contact (see "Connection example 1:" on page 26 and "Connection example 4:" on page 26).

8.2 Structure

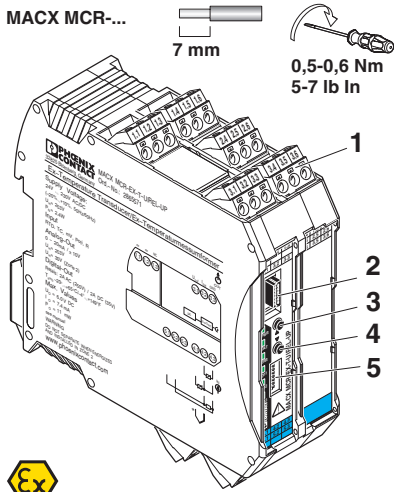

Figure 4 Structure MACX MCR-EX-T-UIREL-UP

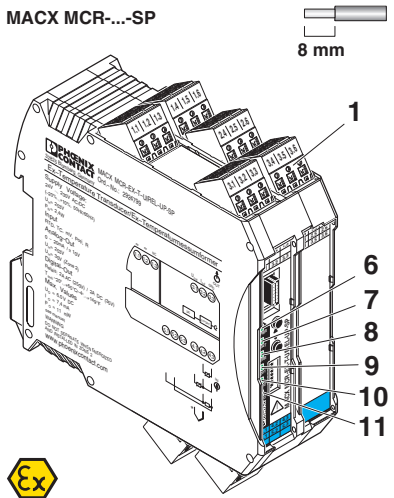

Figure 5 Structure MACX MCR-EX-T-UIREL-UP-SP

- 1 Plug-in COMBICON connectors
- 2 S-PORT (12-pos. programming interface)
- 3 Button S3 (UP), adjustment and reset functions
- 4 Button S2 (DOWN), adjustment and reset functions
- 5 DIP switch S1 for service mode
- 6 PWR LED, green, power supply
- 7 DAT LED, green, no function at present
- 8 ERR LED, red, module, cable and sensor error, under-range or overrange, service mode
- 9 DO1 LED, yellow, status of switching output 1
- 10 DO2 LED, yellow, status of switching output 2
- 11 DO3 LED, yellow, status of switching output 3

8.3 Dimensions

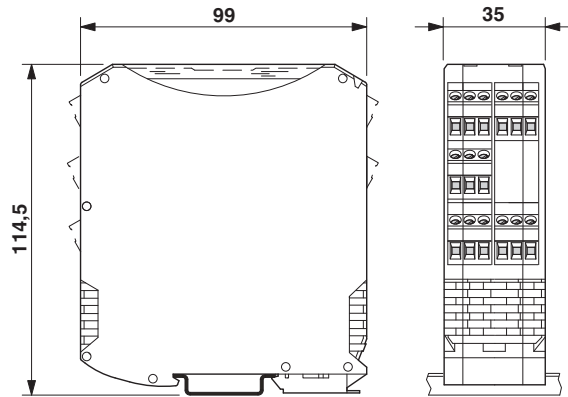

Figure 6 Dimensions (in mm)

8.4 Mounting



WARNING: Explosion hazard

If the module has been used in non-intrinsically safe circuits, it must not be used again in intrinsically safe circuits. The module must be clearly labeled as non-intrinsically safe.

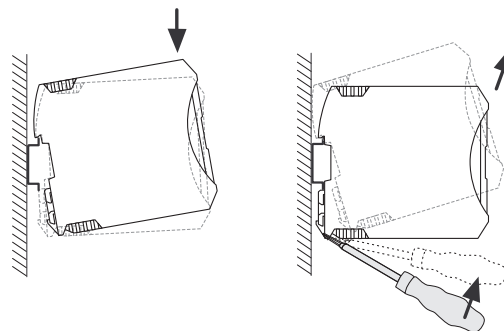

Figure 7 Mounting and removal

- Mount the module on a 35 mm DIN rail according to EN 60715.
- Install the module in a suitable housing to meet the requirements for the protection class.
- Before startup, check for correct function and wiring of the MACX MCR-EX-T-UIREL-UP..., in particular the wiring and marking of the intrinsically safe circuits.

8.5 Connecting the cables

- Screw terminal blocks (for MACX MCR-EX-T-UIREL-UP); litz wires provided with ferrules.
Permissible cable cross section: 0.2 mm² to 2.5 mm²
- Spring-cage terminal blocks (for MACX MCR-EX-T-UIREL-UP-SP); litz wires provided with ferrules.
Permissible cable cross section: 0.2 mm² to 1.5 mm²
- Install intrinsically safe and non-intrinsically safe cables separately.

Screw connection

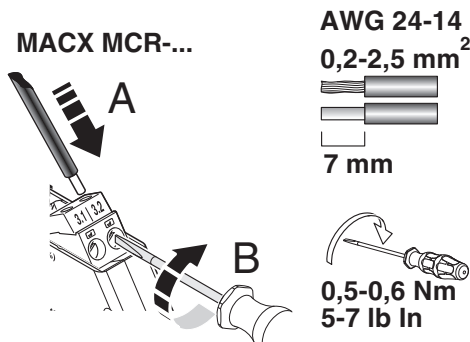

- Insert the conductor into the corresponding connection terminal block.
- Use a screwdriver to tighten the screw in the opening above the connection terminal block.

Spring-cage connection

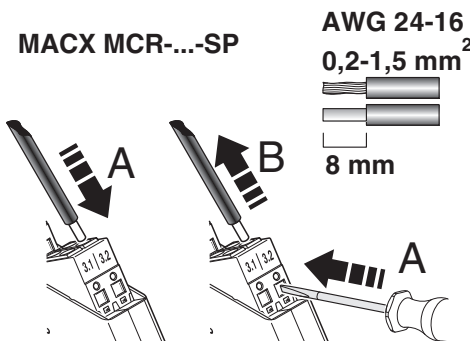

- Insert the conductor into the corresponding connection terminal block.

8.6 Power supply

The power supply has been designed as a wide range power supply (19.2 ... 253 V AC/DC). The module is supplied with voltage via connection terminal blocks 1.1 and 1.2.

8.7 Current output

The current output can be freely configured between 0 and 20 mA. The minimum span is 4 mA. In safety-related applications (SIL = ON), the output is fixed at 4 ...20 mA.

- Connection: Terminals 3.2 "+", 3.3 "-"

8.8 Voltage output



The voltage output cannot be used for safety-related applications (SIL = ON).

The voltage output can be freely configured between -10 and +10 V. The minimum span is 2 V.

- Connection: Terminals 3.1 "+", 3.3 "-"

8.9 Switching output

The three switching outputs each have a PDT. The behavior of each switching output can be configured independently. The switching points SPL¹ and SPH² can be configured across the entire sensor range:

Switching behavior of the switching output

Switching behavior 0



Switching output is permanently dropped.

Switching behavior 1

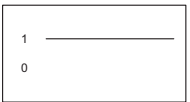

Switching output is permanently picked up.

Switching behavior 2

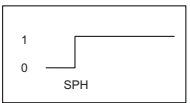

Switching output picks up when SPH² is exceeded.

Switching behavior 3

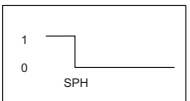

Switching output drops out when SPH² is underrange.

Switching behavior 4

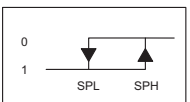

Switching output picks up when SPL² is exceeded and drops out when SPH¹ is underrange (hysteresis).

Switching behavior 5

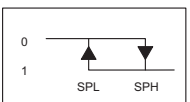

Switching output drops out when SPL² is exceeded and picks up when SPH¹ is underrange (hysteresis).

Switching behavior 6

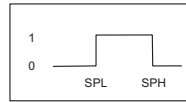

Switching output picks up between SPL¹ and SPH².

Switching behavior 7

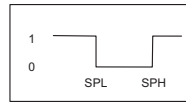

Switching output drops out between SPL¹ and SPH².

¹ SPL = Set Point Low (lower switching point)

² SPH = Set Point High (upper switching point)



Switching output 1 is not intended for safety-related applications.



In SIL ON mode, switching output 1 functions as a simple alarm contact. Switching output 2 in combination with switching output 3 is used for safety-related limit values.



In safety-related applications (SIL), switching outputs 2 and 3 must be combined according to the requirements of the application (see also application examples).

The configuration of switching output 2 is also applied to switching output 3.

In SIL ON mode, switching output 3 cannot be configured separately.



If only the switching outputs are to be used, the current output (connection terminal blocks 3.2 and 3.3) must be short circuited or subjected to a load.

8.10 Switching output behavior with manual acknowledgement (latching)



Latching: No automatic restart after exceeding limit value (SPH: SET Point High) or falling below limit value (SPL: Set Point Low).
 Disable the option "Restart after fail safe" in the configuration software.

8.10.1 Switching behavior (2): Undertemperature limit (\leq SPH)

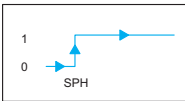

Normal operating state > SPH

Step	Measure
1	Measured value > SPH and module are activated
2	Relay ON
3	Measured value \leq SPH
4	Relay OFF
5	Measured value > SPH
6	Relay Remains OFF (latches) until delay time has passed and then acknowledged manually

Acknowledgement is only possible when there is no critical state anymore and the delay time has passed.

Critical operating state \leq SPH

Step	Measure
1	Measured value \leq SPH and module are activated
2	Relay OFF
3	Measured value > SPH
4	Relay Remains OFF (latches) until delay time has passed and then acknowledged manually

Acknowledgement is only possible when there is no critical state anymore and the delay time has passed.

8.10.2 (Switching behavior (3): Overtemperature limit (\geq SPH)

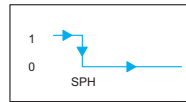

Normal operating state < SPH

Step	Measure
1	Measured value < SPH and module are activated
2	Relay ON
3	Measured value \geq SPH
4	Relay OFF
5	Measured value < SPH
6	Relay Remains OFF (latches) until delay time has passed and then acknowledged manually

Acknowledgement is only possible when there is no critical state anymore and the delay time has passed.

Critical operating state \geq SPH

Step	Measure
1	Measured value \geq SPH and module are activated
2	Relay OFF
3	Measured value < SPH
4	Relay Remains OFF (latches) until delay time has passed and then acknowledged manually

Acknowledgement is only possible when there is no critical state anymore and the delay time has passed.

8.10.3 Switching behavior (4): Undertemperature limit with hysteresis (\leq SPL)

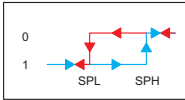

Normal operating state $>$ SPL

Step	Measure
1	Measured value $>$ SPL and module are activated
2	Relay ON
3	Measured value \leq SPL
4	Relay OFF
5	Measured value $>$ SPH
6	Relay Remains OFF (latches) until delay time has passed and then acknowledged manually

Acknowledgement is only possible when there is no critical state anymore and the delay time has passed.

Critical operating state \leq SPL

Step	Measure
1	Measured value \leq SPL and module are activated
2	Relay OFF
3	Measured value $>$ SPH
4	Relay Remains OFF (latches) until delay time has passed and then acknowledged manually

Acknowledgement is only possible when there is no critical state anymore and the delay time has passed.

8.10.4 Switching behavior (5): Overtemperature limit with hysteresis (\geq SPH)

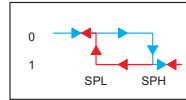

Normal operating state $<$ SPH

Step	Measure
1	Measured value $<$ SPH and module are activated
2	Relay ON
3	Measured value \geq SPH
4	Relay OFF
5	Measured value $<$ SPL
6	Relay Remains OFF (latches) until delay time has passed and then acknowledged manually

Acknowledgement is only possible when there is no critical state anymore and the delay time has passed.

Critical operating state \geq SPH

Step	Measure
1	Measured value \geq SPH and module are activated
2	Relay OFF
3	Measured value $<$ SPL
4	Relay Remains OFF (latches) until delay time has passed and then acknowledged manually

Acknowledgement is only possible when there is no critical state anymore and the delay time has passed.

8.10.5 Switching behavior (6): Temperature range limit (\leq SPL and \geq SPH)

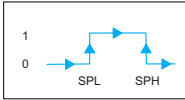

Normal operating state $>$ SPL and $<$ SPH

Step	Measure
1	Measured value $>$ SPL and $<$ SPH module are activated
2	Relay ON
3	Measured value \leq SPL or \geq SPH
4	Relay OFF
5	Measured value $>$ SPL or $<$ SPH
6	Relay Remains OFF (latches) until delay time has passed and then acknowledged manually

Acknowledgement is only possible when there is no critical state anymore and the delay time has passed.

Critical operating state \leq SPL and \geq SPH

1	Measured value a) \leq SPL and module are activated b) \geq SPH and module are activated
2	Relay OFF
3	Measured value a) $>$ SPL and $<$ SPH b) $<$ SPH and $>$ SPL
4	Relay Remains OFF (latches) until delay time has passed and then acknowledged manually

Acknowledgement is only possible when there is no critical state anymore and the delay time has passed.

8.10.6 Switching behavior (7): Temperature range limit (\geq SPL and \leq SPH)

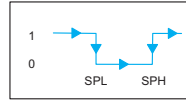

Normal operating state $<$ SPL and $>$ SPH

Step	Measure
1	Measured value a) $<$ SPL and module are activated b) $>$ SPH and module are activated
2	Relay ON
3	Measured value a) \geq SPL and \leq SPH b) \leq SPH and \geq SPL
4	Relay OFF
5	Measured value $<$ SPL or $>$ SPH
6	Relay Remains OFF (latches) until delay time has passed and then acknowledged manually

Acknowledgement is only possible when there is no critical state anymore and the delay time has passed.

Critical operating state \geq SPL and \leq SPH

Step	Measure
1	Measured value \geq SPL and \leq SPH and module are activated
2	Relay OFF
3	Measured value $<$ SPL or $>$ SPH
4	Relay Remains OFF (latches) until delay time has passed and then acknowledged manually

Acknowledgement is only possible when there is no critical state anymore and the delay time has passed.











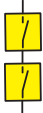



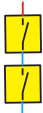









8.11 Connection of relay contacts

In order to select a suitable relay to be used, you must define which state you require when the measuring transducer fails.

You can continue to configure the behavior of the measuring transducer as desired in normal operation, however the connection used for a fault must be taken into account.

If you require a closed contact in the event of a fault, you must connect two N/C contacts in parallel.

If you require an open contact in the event of a fault, you must connect two N/O contacts in series.

Regular function		Closing behavior	Opening behavior	Closing behavior	Opening behavior
Safe state of switch contact		Open	Closed	Closed	Open
Connecting the relay contacts					
Set switching behavior (SV)		Normal (SV 0, 2, 4, 6)	Normal (SV 0, 2, 4, 6)	Inverse (SV 1, 3, 5, 7)	Inverse (SV 1, 3, 5, 7)
Relay contacts before reaching the switching thresholds	Without errors				
	With errors	Defective function working 	Defective function working 	Defective function disrupted 	Defective function disrupted 
Relay contacts after reaching the switching thresholds	Without errors				
	With errors	Defective function disrupted 	Defective function disrupted 	Defective function working 	Defective function working 
Blue cable = voltage-free					
Red cable = live					
 if defective	Defective = the contact is incorrectly actuated or it has been mechanically short-circuited				
 if defective	Defective = the contact is incorrectly not actuated or it has been mechanically short-circuited				
 if defective	Defective = the contact is incorrectly actuated or it has been mechanically interrupted				
 if defective	Defective = the contact is incorrectly not actuated or it has been mechanically interrupted				

8.12 Monitoring function

The temperature transducer is equipped with monitoring functions for the input and output range.

Input monitoring function

The input monitoring function for line break and short circuit refers to the sensor connected to the input. When an error is detected, the output signal is set to the configured error value. In the case of RTD sensors and resistance-type sensors, short-circuit failures are detected resistance values $< 1 \Omega$.

Short circuits of thermocouples and mV sources cannot be detected, since 0 V can be a valid signal.

On RTD sensors, resistance-type sensors and potentiometers, a line break is detected when the current flow through the sensor is faulty.

As soon as the fault has been eliminated, the temperature transducer continues to perform its normal functions. (see "LED status indicators" on page 23, Line faults)

Output monitoring function

The current output can be monitored for line breaks and maximum load. This is activated via the configuration. In safety-related applications (SIL = ON), the output monitoring is always active. The voltage output is not monitored. As soon as the fault has been eliminated, the temperature transducer continues to perform its normal functions. (see "LED status indicators" on page 23, Line faults)

8.13 Operating modes



If the configuration is modified using the IFS-OP-UNIT operator interface and PC-based software (e.g., ANALOG-CONF) or via DIP switch, the changes made must always be checked again and released before transfer to the temperature transducer.

After the transfer, the new data in the temperature transducer is applied by means of activation and a warm start.

8.13.1 SIL ON/SIL OFF

The temperature transducer can either be operated in SIL ON or SIL OFF. The standard configuration is SIL ON with DIP switch S1 set to the OFF position. With the order configuration, customer-specific configurations can be selected in the order key (see "Sensor types" on page 9).

8.13.2 Service mode

Service mode can be selected at any time via the IFS-OP-UNIT operator interface and the configuration software, e.g., ANALOG-CONF or via DIP switch S1.

If settings are changed during service mode and service mode is then exited, the temperature transducer performs a warm start in order to apply the newly set values. If no changes are made, the transducer starts up in normal measuring mode without a warm start. The switching output switches according to its configuration.

In service mode, it is also possible to simulate the output signal independently of the input signal (force). In this case, in safety-related applications the safety function of the device is deactivated and the initial value for the analog output signal is 2 mA, which allows subsequent devices to detect the deviation from normal operation as a result of the measured value being underrange.

During service mode, the switching output is deactivated and remains in its idle position.

9 Configuration



WARNING: Explosion hazard

When configuring in zone 2, the PC used must be approved for use in zone 2.

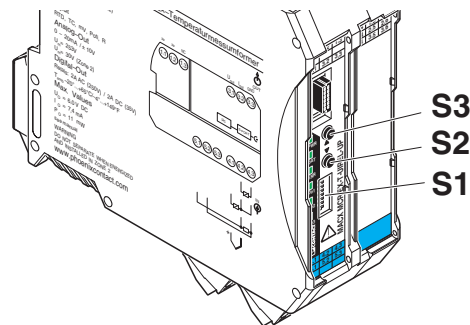

Figure 8 Position of the DIP switch and button



When a DIP switch from S1-2 ... S1-8 (ON) is switched on, the device is switched to service mode. The red ERR LED flashes (1.2 Hz) and a diagnostic I/O fault is displayed in the start screen.

9.1 Delivered state/standard configuration

Switch position DIP-S1							
1	2	3	4	5	6	7	8
OFF	OFF	OFF	OFF	OFF	OFF	OFF	OFF

9.2 Zero adjust, adjustment via buttons S2 and S3 (only possible with SIL OFF)

- Set the adjustment by setting DIP switch S1-2 to ON.
- Observe the analog output and set it with button S2 (descending value) or S3 (ascending value) or press the buttons S2 and S3 simultaneously time for > 3 seconds to reset the cable compensation.
- Save the set value by setting DIP switch S1-2 back to OFF.

Switch position DIP-S1							
1	2	3	4	5	6	7	8
OFF	ON	OFF	OFF	OFF	OFF	OFF	OFF

9.3 Span adjust, adjustment via buttons 2 and 4 (only possible with SIL OFF)

- Set the adjustment by setting DIP switch S1-3 to ON.
- Observe the analog output and set it with button S2 (descending value) or S3 (ascending value) or press the buttons S2 and S3 simultaneously time for > 3 seconds to reset the cable compensation.
- Save the set value by setting DIP switch S1-3 back to OFF.
- Pressing buttons S2 and S3 simultaneously for > 3 seconds resets the adjustment.

Switch position DIP-S1							
1	2	3	4	5	6	7	8
OFF	OFF	ON	OFF	OFF	OFF	OFF	OFF

9.4 Force output



When SIL is activated, the analog output starts at 2 mA and the switching output is deactivated.

- Set the adjustment by setting DIP switch S1-4 to ON.
- Observe the analog output and set with the S2 (descending value) or S3 (ascending value) button.
- The specification/simulation is reset and ended by setting DIP switch S1-4 back to OFF.

Switch position DIP-S1							
1	2	3	4	5	6	7	8
OFF	OFF	OFF	ON	OFF	OFF	OFF	OFF

9.5 Cable compensation, 2-wire RTD or RTD 1 with 2 x RTD

- Set the cable compensation RTD 1 via DIP switches S1-1 to OFF and S1-5 to ON.
- Short circuit the sensor.
- Apply the current measured value as the cable resistance by pressing the S2 button.
- Save the set value by setting DIP switch S1-5 back to OFF.

Pressing buttons S2 and S3 simultaneously for > 3 seconds resets the cable compensation.

Switch position DIP-S1							
1	2	3	4	5	6	7	8
OFF	OFF	OFF	OFF	ON	OFF	OFF	OFF

9.6 Cable compensation RTD 2 with 2 x RTD or TC with external cold junction compensation (TC + CJ external)

- Set the cable compensation RTD 2 via DIP switches S1-1 to ON and S1-5 to ON.
- Short circuit the sensor.
- Apply the current measured value as the cable resistance by pressing the S2 button.
- Save the set value by setting DIP switches S1-1 and S1-5 back to OFF.

Pressing buttons S2 and S3 simultaneously for > 3 seconds resets the cable compensation.

Switch position DIP-S1							
1	2	3	4	5	6	7	8
ON	OFF	OFF	OFF	ON	OFF	OFF	OFF

9.7 Automatic potentiometer adjustment (teach-in)

- Set the teach-in by setting DIP switch S1-6 to ON.
- Set potentiometer to start of range.
- Press the S2 button.
- Set potentiometer to end of range.
- Press the S3 button.
- Save the new measuring range by setting DIP switch S1-6 back to OFF.

Pressing buttons S2 and S3 simultaneously for > 3 seconds resets both values.

Switch position DIP-S1							
1	2	3	4	5	6	7	8
OFF	OFF	OFF	OFF	OFF	ON	OFF	OFF

9.8 Manual acknowledgement of switching outputs (latch function)

Switching output 1

- Set manual acknowledgment of switching output by setting DIP switch S1-7 to ON.
- Press buttons S2 and S3 simultaneously for > 3 seconds.

Reset DIP switch S1-7 to OFF.

Switch position DIP-S1							
1	2	3	4	5	6	7	8
OFF	OFF	OFF	OFF	OFF	OFF	ON	OFF

Switching output 2

- Set manual acknowledgment of switching output 2 by setting DIP switch S1-8 to ON.
- Press buttons S2 and S3 simultaneously for > 3 seconds.

Reset DIP switch S1-8 to OFF.

Switch position DIP-S1							
1	2	3	4	5	6	7	8
OFF	OFF	OFF	OFF	OFF	OFF	OFF	ON

Switching output 3

- Set manual acknowledgment of switching output 3 by setting DIP switches S1-7 and S1-8 to ON.
- Press buttons S2 and S3 simultaneously for > 3 seconds.

Reset DIP switches S1-7 and S1-8 to OFF..

Switch position DIP-S1							
1	2	3	4	5	6	7	8
OFF	OFF	OFF	OFF	OFF	OFF	ON	ON

9.9 LED status indicators

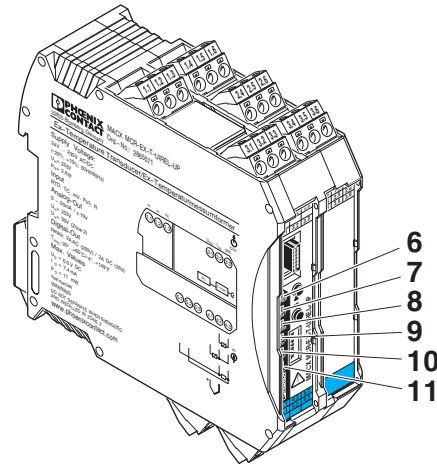

Figure 9 LED status indicators

No.	LED	Color	Description
6	PWR	Green	Supply voltage
		ON	Indicates the readiness for operation of the temperature transducer if supply voltage is available. The temperature transducer is configured without device supply via programming adapter IFS-USB-PROG-ADAPTER.
7	DAT	Green	No function at present
8	ERR	Red	Error
		ON	Module error
		Flashing (1.2 Hz)	Service mode active
		Flashing (2.4 Hz)	Line fault
9	DO1	Yellow	Switching output 1
		ON	Switching output active
10	DO2	Yellow	Switching output 2
		ON	Switching output active
11	DO3	Yellow	Switching output 3
		ON	Switching output active

10 Password

The device is protected by means of a four-digit password set in the factory in order to prevent impermissible changes to the configuration.

Default setting: 1111



For safety-related applications, the password set in the factory must always be changed. If the password is lost, it is not possible to reset it. In this case, please contact Phoenix Contact.

If, however, only data from the device is to be displayed or the device is to be used in non-safety-related applications, the password can be deactivated.

Setting: 0000

The device can be accessed either via the IFS-OP-UNIT (Order No. 2811899) or via a service PC with connected programming adapter IFS-USB-PROG-ADAPTER (Order No.: 2811271) and the ANALOG-CONF configuration software.



Further information on configuration with the IFS-OP-UNIT or the ANALOG-CONF configuration software can be found in the relevant user manual.



WARNING: If *Functional Safety* is activated by a reconfiguration or changes are made to the active *Functional Safety* configuration, the rules under "Installation and startup" must be observed.



WARNING: Limitations on safety-related applications

Only 4 ... 20 mA, limited programming of output current in the event of line faults
($2 \text{ mA} \leq I_{\text{Out}} \leq 3.6 \text{ mA}$ or $I_{\text{Out}} \geq 21 \text{ mA}$)



WARNING: Once new configuration data has been written, the device performs a warm start that changes the properties of the device. The following control device must be adapted to these modifications.



NOTE: Write the changed password to the temperature transducer in order to save it.

11 Configuration with the service PC

When making changes to the configuration data, use the ANALOG-CONF software (free download: phoenixcontact.net/products).



Information on configuration, parameterization and service options (e.g., online monitoring) and their execution can be found in the online help of the software and in the associated user manuals of the DTMs (Device Type Manager).

- Connect the device and PC with the help of the IFS-USB-PROG-ADAPTER programming adapter (Order No. 2811271).

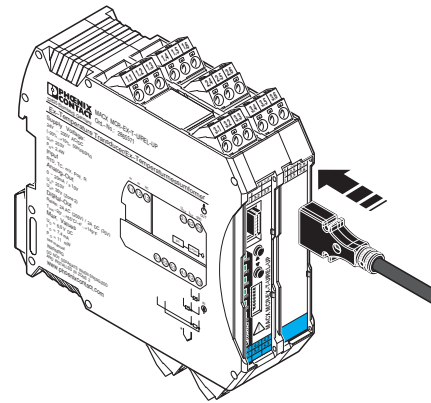

Figure 10 IFS-USB-PROG-ADAPTER

Changes to the configuration and parameterization data can be made during operation with a connected Ex measuring circuit as well as in a disconnected state.

11.1 System requirements

- IBM PC or compatible computer with 400 MHz or higher with at least 256 Mbyte RAM
- At least 15 Mbyte available hard disk space
- Free USB interface, at least USB 1.1.
- Screen resolution of 1024 x 768 pixels
- Windows 2000 SP4, Windows XP SP2



The drivers for the IFS-USB-PROG-ADAPTER USB programming adapter are installed automatically.

11.2 Configuring the user characteristic curve



Freely configurable user characteristic curve for individual adaptation of resistance temperature detectors (RTD) and thermocouples (TC).

The user characteristic curve is created with the PC-based ANALOG-CONF software and stored in the temperature transducer.



The user characteristic curve is either selected with the ANALOG-CONF or with the IFS-OP-UNIT software.

12 Comparison of safety data



WARNING: Explosion hazard

Compare the safety data before connecting a device located in the intrinsically safe area to the MACX MCR-EX-T-UIREL-UP....

Safety data for the

Field devices:	U_i, I_i, P_i, L_i, C_i
Temperature transducers:	U_o, I_o, P_o, L_o, C_o

The values for U_o, I_o, P_o, L_o and C_o can be found under "Safety data according to ATEX for intrinsically safe circuits" on page 7.

Requirements for intrinsic safety (simple circuits):

$$U_i \geq U_o$$

$$I_i \geq I_o$$

$$P_i \geq P_o$$

$$L_i + L_c \leq L_o$$

$$C_i + C_c \leq C_o$$

(L_c and C_c depend on the cables/lines used).

13 Connection examples

13.1 Current output

Connection example 1:

Input: 4-wire RTD
 Output: Current output (4 ... 20 mA) with simple alarm contact (switching output 1) and safe limit value (combination of switching output 2 and 3, N/O contact in series)

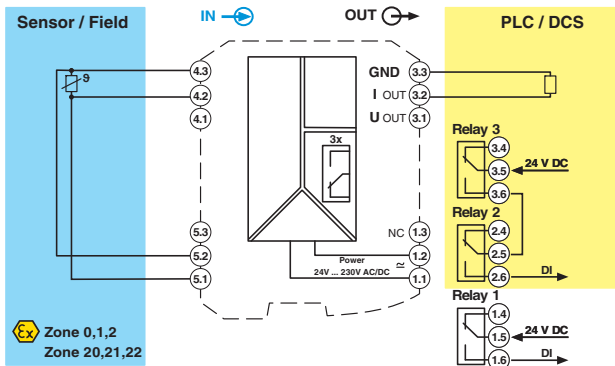

Connection example 2:

Input: Thermocouple with internal cold junction compensation



Use the MACX MCR-EX-CJC cold junction compensation plug provided (Order No. 2925002).

Output: Current output (4 ... 20 mA) with simple signal contact (switching output 1, N/O contact) and safe limit value (combination of switching output 2 and 3, N/C contact in parallel)

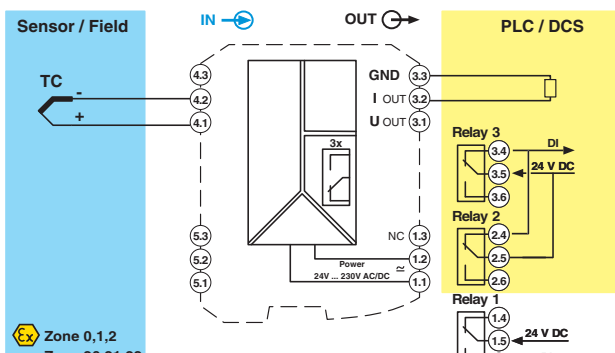

Connection example 3:

Input: Thermocouple with internal cold junction compensation



Use the MACX MCR-EX-CJC cold junction compensation connector provided (Order No. 2925002).

Output: Current output (4 ... 20 mA) with simple alarm contact (switching output 1, N/O contact) and safe limit value (combination of switching output 2 and 3, N/C contact in parallel) on safe controller with comparison of plausibility

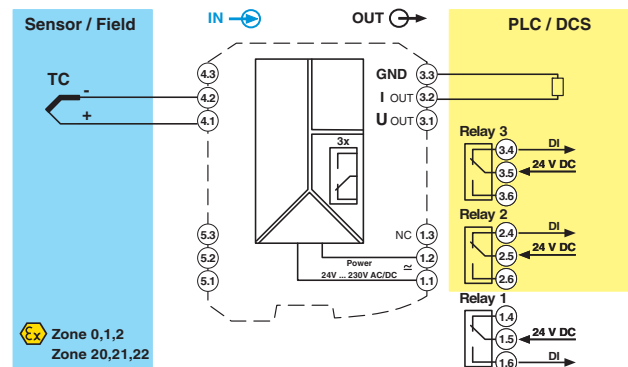

Connection example 4:

Input: Thermocouple with external or without internal cold junction compensation or voltage input

Output: Current output (4 ... 20 mA) with simple alarm contact (switching output 1, N/O contact) and safe limit value (combination of switching output 2 and 3, N/O contact in series)

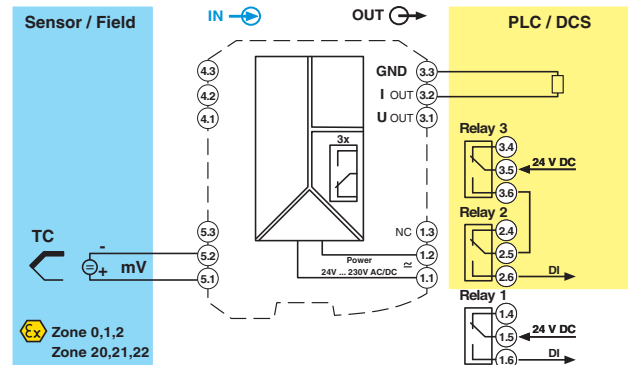

Connection example 5:

Input: Potentiometer
 Output: Current output (0 ... 20 mA) and alarm contacts (switching outputs 1, 2, and 3), can be configured independently.

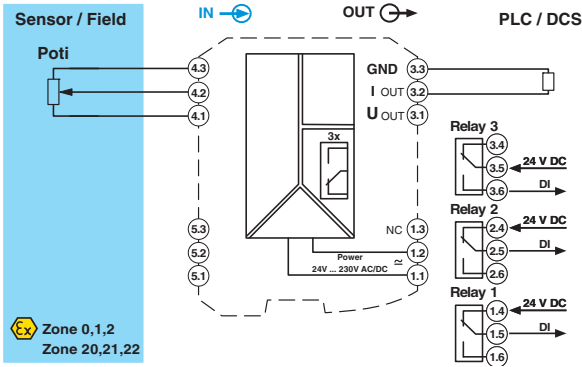

13.2 Voltage output

Connection example:

Input: Potentiometer
 Output: Voltage output (-10 ... 10 V) on passive controller with alarm contacts (switching output 1 and 2), can be configured independently.

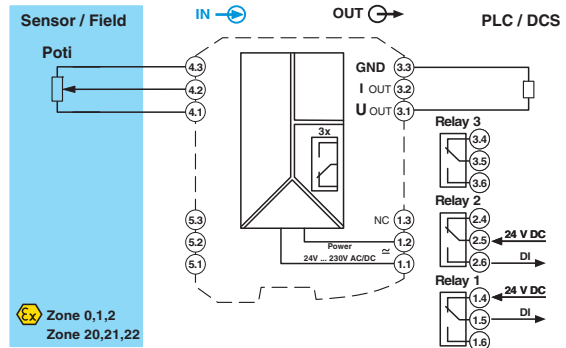

13.3 Switching output

Connection example:

Input: 2 x 2-wire RTD
 Output: Voltage output (-10 ... 10 V)
 Differential RTD1 - RTD2
 Switching output: Switching output 1, 2 and 3 configured independently.

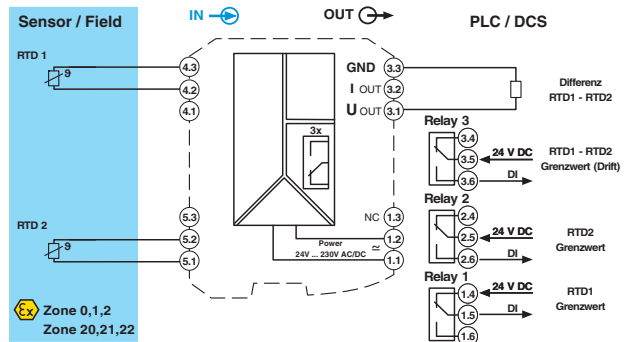

14 Flow chart, operator interface

Configuration with the IFS-OP-UNIT

If you wish to use the MACX MCR-EX-T-UIREL-UP in combination with the IFS-OP-UNIT and with the IFS-OP-CRADLE, the various operating functions that can be selected are shown in the display.

The IFS-OP-UNIT operator interface can either be snapped directly onto compatible 35 mm modules or can be used as a remote display together with the IFS-OP-CRADLE cradle unit.



When active, the SIL function is displayed in the start screen.

Example: Display of SIL ON

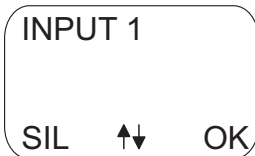

Example: Display of SIL OFF

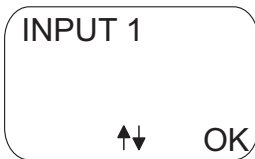

For safety reasons, the SIL ON function cannot be configured via the IFS-OP-UNIT operator interface.



SIL can be switched off/deactivated via the SIL OFF menu item.

To reactivate/switch on the SIL function, PC-based configuration software, e.g., ANALOG-CONF is required.



If no input is entered for five minutes during configuration, the configuration is ended and any unsaved data will be lost.

14.1 Menu structure

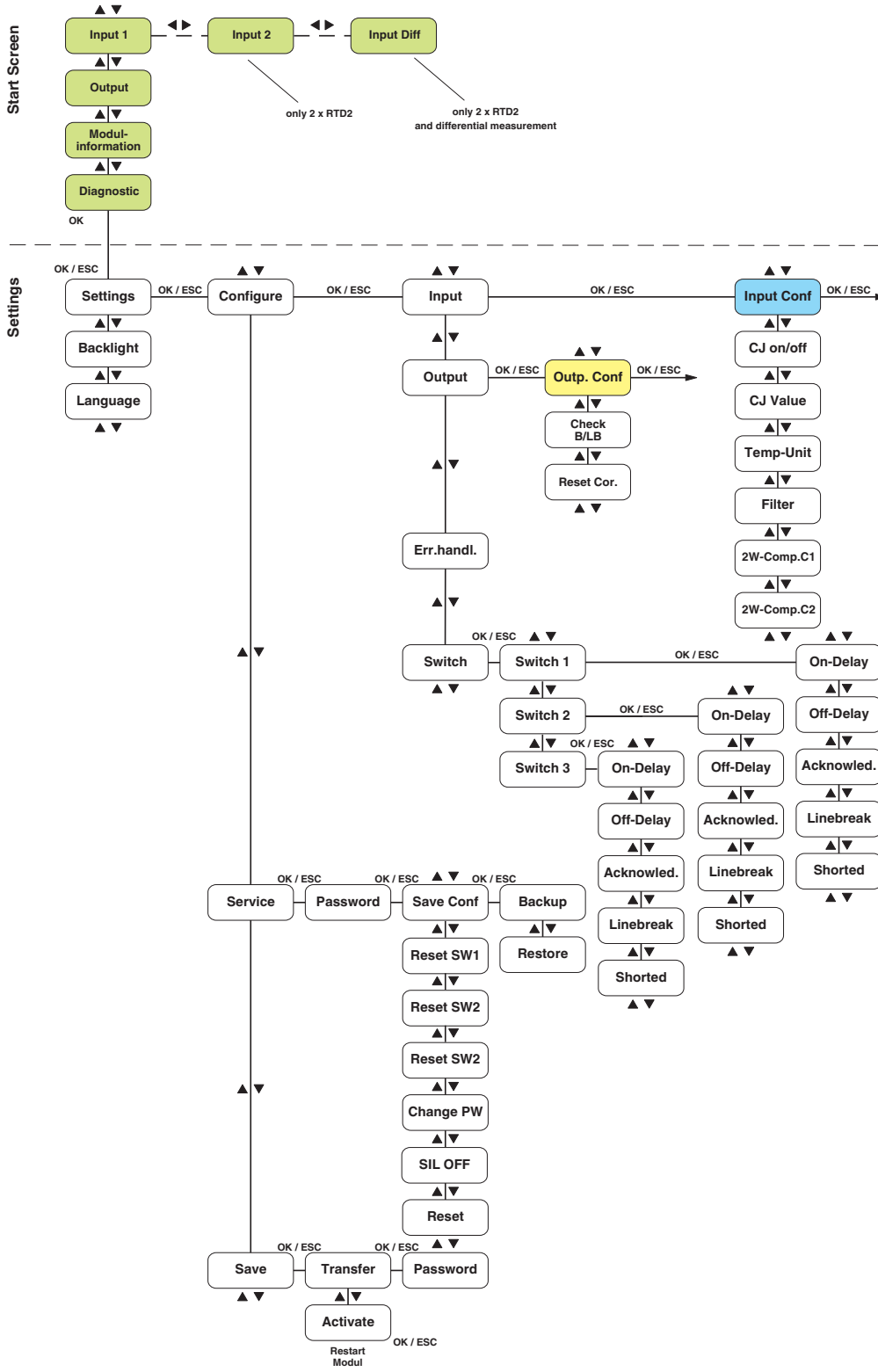

14.2 Key for start screen

Display of input and output signals, module and diagnostic information.

Input 1	Display of the actual value of input 1
Input 2	Display of the actual value of input 2, only if a second RTD is configured with the 2-wire connection method.
Input Diff	Display of the actual value of the differential measurement with 2 x RTD with the 2-wire connection method.
Output	Display of the actual value of the analog output
Modul-information	Display of module information (order designation, firmware version, config version)
Diagnostic	Module diagnostics (simulation, module error, I/O error)

14.3 Key for MENU

Settings	The active configuration is read out from the module.
Backlight	Setting for the background illumination (on , off, autodim)
Language	Setting for the menu language (English , German)

14.4 Key for SETTINGS - Configure

Configure	Configuration of input, output, fault behavior and switching outputs
-----------	--

14.5 Key for SETTINGS - Service

Service	Access to the menu items of the service area
Password	Input of a 4-digit numeric password in order to open the service area (if the password is 0000, the password prompt is switched off)
Save Conf	Access to the menu items for the backup and restore functionality of the module configuration
Reset SW1	Resets switching output 1 when it is snapped on (latching behavior)
Reset SW2	Resets switching output 2 when it is snapped on (latching behavior)
Reset SW3	Resets switching output 3 which it is snapped on (latching behavior) only configurable with SIL OFF.
Change PW	Changes the set password (change only becomes effective when the configuration has been transmitted to the module and activated)

SIL OFF

Changes the setting from SIL ON to SIL OFF.

**NOTE:** It is only possible to switch on the SIL function via PC-based configuration software, e.g., ANALOG-CONF.**Reset**

Resets the IFS-OP-UNIT and the connected module.

Backup

Saves the active configuration of the connected, compatible module in the IFS-OP-UNIT operator interface (copy function)

Restore

Transmits the saved module configuration from the internal memory of the IFS-OP-UNIT operator interface to the connected module (copy function).



Then activate the configuration by selecting Yes in the Activate menu item.

14.6 Key for SETTINGS - Save

Save

Access to the menu items for the transmission and activation of the module configuration

Transfer

Transmits the configuration from the IFS-OP-UNIT operator interface to the connected module

Password

Input of a 4-digit numeric password in order to transmit the configuration (if the password is 0000, the password prompt is switched off).

Activate

Activation of the module configuration (Yes/No)



Following activation, the module performs a warm start.

14.7 Key for input

Input

Access to the menu items for the configuration of the input (see "Key for input configuration (analog input)" on page 32)

14.7.1 Key for input configuration (analog input)

Input Conf

Setting for the dependent parameters of the input mode, sensor type, start and end of range, associated inputs, switching behavior, switching points

CJ on/off

Cold junction compensation with TC + CJ and TC + CJ ext. (on, off)

CJ Value

Correction of the cold junction value with CJ = On, specification of the cold junction value with CJ = Off (-20 ... 65 K).

Temp-Unit

Setting for the temperature unit (°C, °F)

Filter

Setting for the filter factor (1 ... 10)

2W-Comp.C1

Setting for the cable resistance for RTD 2-wire connection method, channel 1 (0 ... 50 Ω).

2W-Comp.C2

Setting for the cable resistance for RTD 2-wire connection method, channel 2 (0 ... 50 Ω).

Configuration selection, input configuration

Input Conf
ESC ↑↓ OK

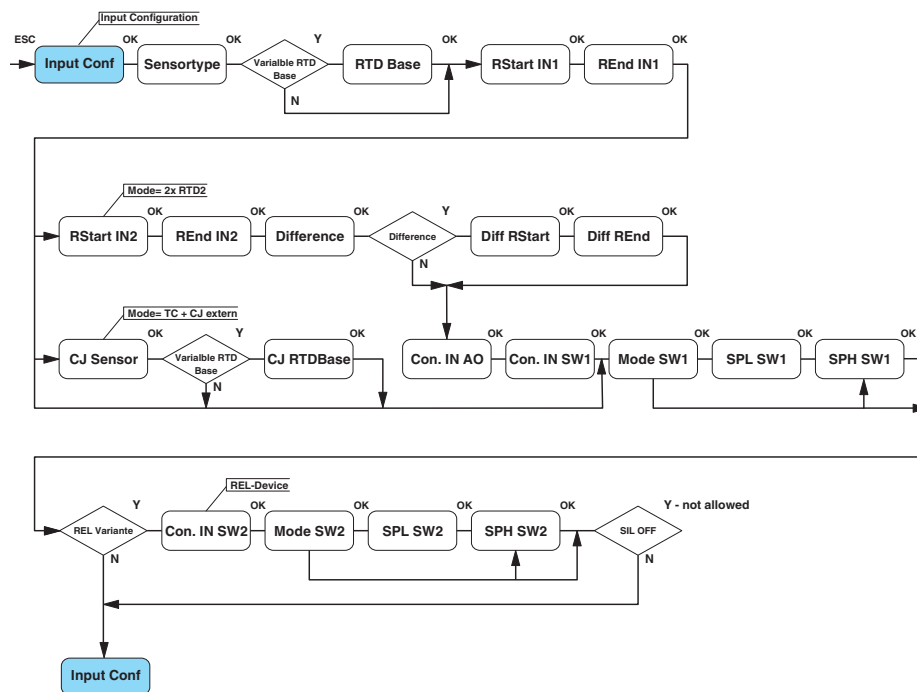

Input Conf	Setting for the sensor mode (RTD4, RTD3, RTD2, 2 x RTD2, TC + CJ, TC + CJ ext., potentiometer, mV).
Sensortype	Setting for the sensor type depending on sensor mode (Pt, Ni, CU, KTY..., USER, for more see "Sensor types" on page 9).
RTD Base	RTD basic resistance for sensor types with a variable basic resistance (e.g., when 100 is selected, the basic resistance is 100 Ω)
RStart IN1	Start of range for input 1 depending on sensor type, e.g., -50°C (°C, °F, Ω , %, mV).
REnd IN1	End of range for input 1 depending on sensor type, e.g., 150°C (°C, °F, Ω , %, mV)
RStart IN2	Start of range for input 2 depending on sensor type and only for 2 x RTD with 2-wire connection method, e.g., -50°C (°C, °F, Ω).
REnd IN2	End of range for input 2 depending on sensor type and only for 2 x RTD with 2-wire connection method, e.g., 150°C (°C, °F, Ω)
Difference	Setting for the differential measurement only for 2 x RTD with 2-wire connection method and not resistance (off, differential, absolute value differential)
Diff RStart	Start of range for differential, only with differential and absolute value differential (°C, °F)
Diff REnd	End of range for differential, only with differential and absolute value differential (°C, °F)
CJ Sensor	Sensor type of the cold junction, only with TC + CJ ext.
CJ RTDBase	RTD basic resistance of the cold junction, only with TC + CJ ext.
Con. IN AO	Associated input of the analog output (input 1, input 2, differential), appears only in sensor mode 2 x RTD2 (2 x RTD 2-wire connection method)
Con. IN SW1	Associated input of switching output 1 (input 1, input 2, differential), appears only in sensor mode 2 x RTD2 (2 x RTD 2-wire connection method).
Mode SW1	Mode of switching output 1 (0 ... 7), see "Switching output" on page 16.
SPL SW1	Setpoint low of switching output 1 (only if mode > 3), see "Switching output" on page 16.
SPH SW1	Setpoint high of switching output 1 (only if mode > 1), see "Switching output" on page 16.
Con. IN SW2	Associated input of switching output 2 (input 1, input 2, differential).
Mode SW2	Mode of switching output 2 (0 ... 7), see "Switching output" on page 16.
SPL SW2	Setpoint low of switching output 2 (only if mode > 3), see "Switching output" on page 16.
SPH SW2	Setpoint high of switching output 2 (only if mode > 1), see "Switching output" on page 16.

Con. IN SW3	Associated input of switching output 3 (input 1, input 2, differential), only configurable with SIL OFF.
Mode SW3	Mode of switching output 3 (0 ... 7), see "Switching output" on page 16, only configurable with SIL OFF.
SPL SW3	Setpoint low of switching output 3 (only if mode > 3), see "Switching output" on page 16, only configurable with SIL OFF.
SPH SW3	Setpoint high of switching output 3 (only if mode > 1), see "Switching output" on page 16, only configurable with SIL OFF.

14.8 Key for output

Output Access to the menu items for the configuration of the output
(see “Key for output configuration (analog output)” on page 35)

14.8.1 Key for output configuration (analog output)

Outp. Conf Setting for the dependent parameters of the analog output – mode, start and end of range, display of correction values, fault behavior (OR, UR, LB, KS) **current/voltage**, voltage only configurable with SIL OFF.

Check B/LB Monitoring of output load/short circuit (**Yes/No**), only configurable with SIL = OFF

Reset Cor. Resets the correction values of the output

Configuration selection, output configuration

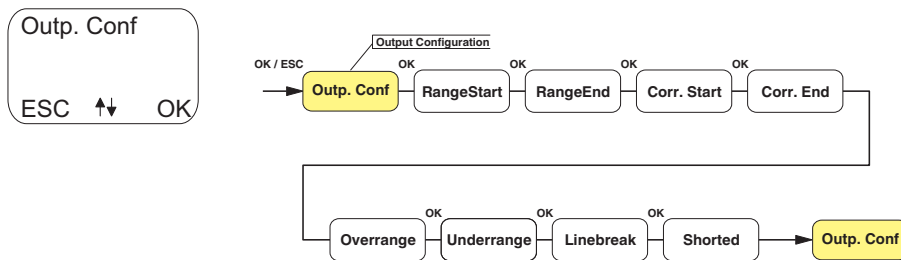

RangeStart Start of range for output – setting only possible with SIL = OFF, **4 mA** (0 ... 20 mA, -10 ... 10 V)

RangeEnd End of range for output – setting only possible with SIL = OFF, **20 mA** (0 ... 20 mA, -10 ... 10 V)

Corr.Start Display of the start correction value for the analog output (mA, V)

Corr.End Display of the end correction value for the analog output (mA, V)

Overrange Analog output value when overrange **NE43 Upsc.** / NE43 Downsc.
(Configurable for fault behavior = freely definable)

Underrange Analog output value for underrange **NE43 Upsc.** / NE43 Downsc.
(Configurable for fault behavior = freely definable)

Linebreak Analog output value in the event of line break **NE43 Upsc.** / NE43 Downsc.
(Configurable for fault behavior = freely definable)

Shorted Analog output value in the event of a short circuit on the line **NE43 Upsc.** / NE43 Downsc.
(Configurable for fault behavior = freely definable)

14.9 Key for error handling

Err.handl. Setting for the fault behavior (NE43 increasing, NE43 decreasing, freely definable)

14.10 Key for switch

Switch Access to the menu items for setting the switching output

14.10.1 Key for switch 1

Switch 1 Access to the menu items for setting switching output 1.

On-Delay Setting for the switch-on delay for switching output 1 (0 ... 10 s)

Off-Delay Setting for the off delay for switching output 1 (0 ... 10 s)

Acknowled. Manually acknowledge switching output 1 (latching) (Yes/**No**).

Linebreak Behavior for switching output 1 in the event of an error - line break (on, **off**, no response)

Shorted Behavior for switching output 1 in the event of an error - short circuit (on, **off**, no response)

14.10.2 Key for switch 2

Switch 2 Access to the menu items for setting switching output 2.

On-Delay Setting for the switch-on delay for switching output 2 (0 ... 10 s)

Off-Delay Setting for the off delay for switching output 2 (0 ... 10 s)

Acknowled. Manually acknowledge switching output 2 (latching) (Yes/**No**)

Linebreak Behavior for switching output 2 in the event of an error - line break (on, **off**, no response).

Shorted Behavior for switching output 2 in the event of an error - short circuit (on, **off**, no response).

14.10.3 Key for switch 3 (only configurable with SIL OFF)

Switch 3

Access to the menu items for setting switching output 3.

On-Delay

Setting for the switch-on delay for switching output 3 (0 ... 10 s)

Off-Delay

Setting for the off delay for switching output 3 (0 ... 10 s)

Acknowled.

Manually acknowledge switching output 3 (latching) (Yes/**No**).

Linebreak

Behavior for switching output 3 in the event of an error - line break (on, **off**, no response).

Shorted

Behavior for switching output 3 in the event of an error - short circuit (on, **off**, no response).

15 IFS-OP-UNIT operator interface error codes

The following error codes are shown directly in the display of the IFS-OP-UNIT operator interface when they occur.

Error code	Description
Error 0	Copy error Module type in the IFS-OP-UNIT is different from the connected module.
Error 1,2,3	Checksum error Please contact Phoenix Contact.

Appendix

A1 Safety-related applications (SIL 2)

Valid hardware and firmware versions



NOTE: Only those devices with SIL designation and device firmware with revision 0.92 or higher are certified for SIL 2.



NOTE: The evaluation unit following the measuring transducer (e.g., safety-related PLC) must recognize these states and correspondingly control the actuator as the final link in the safety chain.

SIL regulations apply to the following modules:

Designation	Order No.
Standard configuration	
MACX MCR-T-UI-UP	28 11 394
MACX MCR-T-UI-UP-SP	28 11 860
MACX MCR-T-UIREL-UP	28 11 378
MACX MCR-T-UIREL-UP-SP	28 11 828
MACX MCR-EX-T-UI-UP	28 65 654
MACX MCR-EX-T-UI-UP-SP	29 24 689
MACX MCR-EX-T-UIREL-UP	28 65 751
MACX MCR-EX-T-UIREL-UP-SP	29 24 799
Order configuration	
MACX MCR-T-UI-UP-C	28 11 873
MACX MCR-T-UI-UP-SP-C	28 11 970
MACX MCR-T-UIREL-UP-C	28 11 514
MACX MCR-T-UIREL-UP-SP-C	28 11 831
MACX MCR-EX-T-UI-UP-C	28 11 763
MACX MCR-EX-T-UI-UP-SP-C	29 24 692
MACX MCR-EX-T-UIREL-UP-C	28 65 722
MACX MCR-EX-T-UIREL-UP-SP-C	29 24 809

The safety-related temperature transducers listed above from the MACX MCR(-EX)-T-... series have been certified by TÜV Nord.

Certificate number: No. SEBS-A122710/12, V1.0

A1.1 Safety function and safety requirements

The safety-related measuring transducers are used for the acquisition of a sensor signal (RTD, TC sensors, resistance-type sensors, mV sources), that is converted into a scaled signal and from which a standardized "life zero" current signal is generated. The entire conversion is continuously monitored to a maximum transmission error of 5%. In the event of greater deviations, the device switches to the safe state. The safe state is an output signal of either < 3.6 mA or > 21 mA.

With the REL versions, an additional signal is generated, which is compared with up to two specified switching thresholds. When the first threshold is reached, the safety relay is switched on without confirmation contact and when the second threshold is reached, it is switched off. Depending on the application, the safety for the switching output is implemented by either the series or parallel connection of relays 2 and 3, a fuse connected in series, and by monitoring the calculated switching value.

If an N/O contact is required, you must connect the N/O contacts of relays 2 and 3 in series. In this way, the safe state (relay coil without power and N/O contact open) is also achieved in the event of a faulty contact (permanently closed) (see also connection example 1).

If an N/C contact is required, you must connect the N/C contacts of relays 2 and 3 in parallel. In this way, the safe state (relay coil without power and N/C contact closed) is also achieved in the event of a faulty contact (permanently open) (see also connection example 2).

In the event of deviations of more than 5%, the device switches to the safe state. The safe state in this case is an uncontrolled relay.

The hardware is also continuously monitored. If an internal failure is detected, the measuring transducer also switches to the safe state (current output < 3.6 mA or > 21 mA or uncontrolled relay).

The transition to the safe state always takes place within the internal failure detection time of 50 s.

The measuring transducer is released (restarted) by switching off the supply voltage and switching it back on again, by resetting the transducer via the serial interface, or by activating the "Restart" option during configuration. The integrated startup tests are then performed. If the error is still present, it will be detected during these tests. If it is still present, the measuring transducer switches back to the safe state.

In addition to the safety functions, there are also monitoring functions for the input and the current output.

Evaluation

Failures which are detected in the measuring transducer and to which the transducer responds by switching to the safe state are safe failures (λ_s).

Failures where the measuring transducer does not follow a change of input signal or generates an output signal that deviates from the intended value by more than $\pm 5\%$, are evaluated as dangerous failures (λ_d).

Both safe (λ_s) and dangerous (λ_d) failures can be detected by diagnostic measures. Detected dangerous failures (λ_{dd}) are handled in the same way as safe failures.

The **monitoring functions** refer to events whose cause is detected and reported outside of the device.

Summary:

Safety/monitoring function	Output signal range	Safe state	Reason
Safety function	4 ... 20 mA	< 3.6 mA; or > 21 mA Relay is not controlled	Deviation > 5%
Input monitoring	4 ... 20 mA	2 - 3.6 mA; > 21 mA	Line fault input
Output monitoring	4 ... 20 mA	= 0 mA	Line fault output

Together with the actual signal transmission, continuous checks and diagnostic functions are performed in the measuring transducers in order to detect faulty behavior.

The **internal failure monitoring time** (diagnostics test interval) is the time taken to carry out and repeat these tests in full. Random hardware faults are detected during this time.

The **internal failure monitoring time** is 50 seconds.

A1.2 Safety integrity requirements



As a result of the multiple connection options, only two device types are considered in the configurations for “RTD 3-wire” or “mV” in the following. They represent all configurations with a variable resistance at the input terminals or voltage or thermocouple inputs and always indicate the most conservative case. The two device types are:

1. MACX MCR(-EX)-T-UI-UP(-SP)(-C)
2. MACX MCR(-EX)-T-UIREL-UP(-SP)(-C)



FIT (Failure In Time)
1 FIT is 1 failure in 10^9 hours

A1.2.1 Failure rates: MACX MCR(-EX)-T-UIREL-UP(-SP)(-C)

Input: RTD 3-wire connection method
Output: Switching output 2 and 3 (redundant)

- Type B device (according to EN 61508-2)
- Safety Integrity Level (SIL) 2
- HFT = 0
- 1oo1d architecture

λ_{SD}	λ_{SU}	λ_{DD}	λ_{DU}	SFF	DC _D
0	2.34 * 10^{-7}	5.43 * 10^{-7}	0.43 * 10^{-7}	94%	92 %
0 FIT	234 FIT	543 FIT	43 FIT		

The total failure rate is: $1.34 * 10^{-6}$

The MTBF (Mean Time Between Failures) is therefore 85 years.

The probability of a dangerous failure per hour for “continuous demand” mode and the average probability of failure of the specified function for “low demand” mode are determined from the error rate:

PFD_{avg} values

T[PROOF] =	1 year	2 years	5 years
PFD _{avg} =	$2.88 * 10^{-4}$	$4.67 * 10^{-4}$	$1.01 * 10^{-3}$

PFH* = $4.3 * 10^{-8}$ /h

The calculation is performed assuming a checking interval (T_{PROOF}) of 1 year and a repair time (MTTR) of 24 hours, a test coverage (CPT) of 95% and a life time (LT) of 10 years.

On the basis of the value determined for the average probability of failure **PFD_{avg}**, the checking interval can be increased to up to 5 years.

The values are valid under the following conditions:

- The failure rates of the components used remain constant throughout the period of use.
- The propagation of failures by the device in the system is not taken into consideration.
- The repair time (replacement) is 24 hours.
- The failure rates of the external power supply unit are not taken into consideration.
- The average temperature at which the device is to be used is 40°C. In this case, normal industrial conditions are assumed.
- The specified failure rates are based on an average ambient temperature of 40°C. For an average ambient temperature of 60°C, the failure rates must be multiplied by factor 2.5. Factor 2.5 is based on guide values.

1.2.2 Failure rates: MACX MCR(-EX)-T-UIREL-UP (-SP)(-C)

Input: Voltage input mV
 Output: Switching output 2 and 3 (redundant)

- Type B device (according to EN 61508-2)
- Safety Integrity Level (SIL) 2
- HFT = 0
- 1oo1d architecture

λ_{SD}	λ_{SU}	λ_{DD}	λ_{DU}	SFF	DC _D
0	2.38 * 10 ⁻⁷	5.22* 10 ⁻⁷	0.56 * 10 ⁻⁷	93%	90%
0 FIT	238 FIT	522 FIT	56 FIT		

The total failure rate is: 1.34 * 10⁻⁶

The MTBF (Mean Time Between Failures) is therefore 85 years.

The probability of a dangerous failure per hour for “continuous demand” mode and the average probability of failure of the specified function for “low demand” mode are determined from the error rate:

PFD_{avg} values

T[PROOF] =	1 year	2 years	5 years
PFD _{avg} =	3.67 * 10 ⁻⁴	5.99 * 10 ⁻⁴	1.30 * 10 ⁻³

PFH* = 5.6 * 10⁻⁸/h

The calculation is performed assuming a checking interval (T_{PROOF}) of 1 year and a repair time (MTTR) of 24 hours, a test coverage (CPT) of 95% and a life time (LT) of 10 years.

On the basis of the value determined for the average probability of failure **PFD_{avg}**, the checking interval can be increased to up to 5 years if the percentage of the device for the entire loop is assumed at 10%.

The values are valid under the following conditions:

- The failure rates of the components used remain constant throughout the period of use.
- The propagation of failures by the device in the system is not taken into consideration.
- The repair time (replacement) is eight hours.
- The failure rates of the external power supply unit are not taken into consideration.

- The average temperature at which the device is to be used is 40°C. In this case, normal industrial conditions are assumed.
- The specified failure rates are based on an average ambient temperature of 40°C. For an average ambient temperature of 60°C, the failure rates must be multiplied by factor 2.5. Factor 2.5 is based on guide values.

1.2.3 Failure rates: MACX MCR(-EX)-T-UI-UP(-SP) (-C)

Input: RTD 3-wire connection method
 Output: 4 ... 20 mA (current output)

- Type B device (according to EN 61508-2)
- Safety Integrity Level (SIL) 2
- HFT = 0
- 1oo1d architecture

λ_{SD}	λ_{SU}	λ_{DD}	λ_{DU}	SFF	DC _D
0	0	8.05* 10 ⁻⁷	0.43 * 10 ⁻⁷	94%	94%
0 FIT	0 FIT	805 FIT	43 FIT		

The total failure rate is: 1.18 * 10⁻⁶

The MTBF (Mean Time Between Failures) is therefore 97 years.

The probability of a dangerous failure per hour for “continuous demand” mode and the average probability of failure of the specified function for “low demand” mode are determined from the error rate:

PFD_{avg} values

T[PROOF] =	1 year	2 years	5 years
PFD _{avg} =	2.95 * 10 ⁻⁴	4.76 * 10 ⁻⁴	1.02 * 10 ⁻³

PFH* = 4.3 * 10⁻⁸/h

The calculation is performed assuming a checking interval (T_{PROOF}) of 1 year and a repair time (MTTR) of 24 hours, a test coverage (CPT) of 95% and a life time (LT) of 10 years.

On the basis of the value determined for the average probability of failure **PFD_{avg}**, the checking interval can be increased to up to 5 years.

The values are valid under the following conditions:

- The failure rates of the components used remain constant throughout the period of use.
- The propagation of failures by the device in the system is not taken into consideration.
- The repair time (replacement) is eight hours.
- The failure rates of the external power supply unit are not taken into consideration.
- The average temperature at which the device is to be used is 40°C. In this case, normal industrial conditions are assumed.
- The specified failure rates are based on an average ambient temperature of 40°C. For an average ambient temperature of 60°C, the failure rates must be multiplied by factor 2.5. Factor 2.5 is based on guide values.

1.2.4 Failure rates: MACX MCR(-EX)-T-UI-UP(-SP) (-C)

Input: Voltage input mV
 Output: 4 ... 20 mA (current output)

- Type B device (according to EN 61508-2)
- Safety Integrity Level (SIL) 2
- HFT = 0
- 1oo1d architecture

λ_{SD}	λ_{SU}	λ_{DD}	λ_{DU}	SFF	DC _D
0	0	7.89* 10 ⁻⁷	0.56* 10 ⁻⁷	93%	93%
0 FIT	0 FIT	789 FIT	56 FIT		

The total failure rate is: 1.19 * 10⁻⁶

The MTBF (Mean Time Between Failures) is therefore 96 years.

The probability of a dangerous failure per hour for “continuous demand” mode and the average probability of failure of the specified function for “low demand” mode are determined from the error rate:

PFD_{avg} values

T[PROOF] =	1 year	2 years	5 years
PFD _{avg} =	3.75 * 10 ⁻⁴	6.08 * 10 ⁻⁴	1.31 * 10 ⁻³

PFH* = 5.6 * 10⁻⁸/h

The calculation is performed assuming a checking interval (T_{PROOF}) of 1 year and a repair time (MTTR) of 24 hours, a test coverage (CPT) of 95% and a life time (LT) of 10 years.

On the basis of the value determined for the average probability of failure **PFD_{avg}**, the checking interval can be increased to up to 5 years.

The values are valid under the following conditions:

- The failure rates of the components used remain constant throughout the period of use.
- The propagation of failures by the device in the system is not taken into consideration.
- The repair time (replacement) is eight hours.
- The failure rates of the external power supply unit are not taken into consideration.
- The average temperature at which the device is to be used is 40°C. In this case, normal industrial conditions are assumed.
- The specified failure rates are based on an average ambient temperature of 40°C. For an average ambient temperature of 60°C, the failure rates must be multiplied by factor 2.5. Factor 2.5 is based on guide values.

A1.3 Configuring an SIL device

The measuring transducer can be ordered with a standard configuration (see 1.) or configured for safety-related applications (see 2.), or can be configured by users themselves for safety-related applications (see 3.).

1. The measuring transducers are delivered with a standard configuration for safety-related applications with a 4 - 20 mA output (see order key).
2. Customer-specific pre-configured devices (-C) can be delivered for both safety-related applications and “normal” usage. Configuration data is shown on a label.
3. The measuring transducers can also be configured by users for both safety-related applications and “normal” usage.

The configuration can be read out and changed at any time for all devices.



For safety-related applications, the password set in the factory must always be changed.
 If the password is lost, it is not possible to change the configuration.
 In this case, please contact Phoenix Contact.

Configuring safety-related applications

- Connect the device and PC with the help of the IFS-USB-PROG-ADAPTER programming adapter (Order No. 2811271).
- Load the ANALOG-CONF configuration software (free download at: phoenixcontact.net/products). Further information on the FDT frame application (ANALOG-CONF) and the device drivers (DTM) can be found in the ANALOG-CONF user manual.
- Read out the active configuration.
- Enter the password in the ANALOG-CONF in the "PIN" hardware configuration (set to 1111 in the factory).
- Activate/deactivate SIL.

In the case of "SIL ON", it is also possible to deactivate the "Restart after failsafe" item here.

This means that in the event of a failure, the measuring transducer enters the failsafe state according to the safety functions, but is not restarted.

- Write the modified configuration data to the measuring transducer.
- Check that the new configuration data in the control window is correct and confirm with "OK" or "Cancel" if not correct.



NOTE: Installation, operation, and maintenance may only be carried out by qualified specialist personnel.



WARNING: If *Functional Safety* is activated by a reconfiguration or changes are made to the active *Functional Safety* configuration, the rules under "Installation and startup" must be observed.



WARNING: Limitations on safety-related applications

Only 4 ... 20 mA, limited programming of output current in the event of line faults
($2 \text{ mA} \leq I_{\text{Out}} \leq 3.6 \text{ mA}$ or $I_{\text{Out}} \geq 21 \text{ mA}$)



WARNING: Once new configuration data has been written, the device performs a warm start that changes the properties of the device. The following control device must be adapted to these modifications.



WARNING: The device must be write-protected to prevent improper use. Write protection is created by assigning a password.

A1.4 Installation and startup

During installation, always observe the package slips

Designation	MNR No.
PACKB.MACX MCR-T-UI-UP...	9055145
PACKB.MACX MCR-EX-T-UI-UP...	9055147
PACKB.MACX MCR-T-UIREL-UP...	9055146
PACKB.MACX MCR-EX-T-UIREL-UP...	9055148

The package slip is supplied with the device. It can also be downloaded at: phoenixcontact.net/products.

Lockable housing with IP54 protection is recommended for the installation of the measuring transducer.

- Check that the configuration of the measuring transducer is correct for the intended application.
- Connect the measuring transducer according to the installation instructions.
- Make sure that the connected sensor corresponds to the configuration.
- Check the functionality of the measuring transducer with connected sensor for correct function. A calibrated sensor simulator (RTD/TC) and a calibrated digital multimeter are necessary for checking the measuring transducer.
- Start up the loop and check that it operates correctly.

A1.5 Notes on operation

Only the green LED (PWR) is on during normal operation.

If a malfunction occurs during operation and the red LED (ERR) flashes, there is a line fault. The output current of the measuring transducer is between 2 ... 3.6 mA or is higher than 21.0 mA (in the case of faults in the sensor circuit) or is 0 mA (in the case of a line break in the output circuit).

Check all signal lines. The device will automatically switch back to normal operation after the fault has been eliminated.

If a fault occurs during operation and the red LED (ERR) is permanently on, the device has switched to the "safe state" (output current is less than 2 mA).

Restart the device in order to return it to normal operation.

- If no PC/laptop has been connected, you can also interrupt the power supply.
- Or you can carry out a warm start with the help of the configuration software (*Service > Reset*).

The measuring transducer should then return to normal operation. If it does not, the measuring transducer must be replaced.

A1.6 Recurring checks (SIL 2)

The function of the entire safety loop must be checked regularly according to EN 61508 and EN 61511. The intervals for checking are specified by the intervals of each individual device within the safety loop.

It is the operator's responsibility to select the type of checks and the checking intervals in the specified time period.

The measuring transducers must be checked at least every 7 years (maximum proof test interval).

Checking must be carried out in such a way that the correct function of the safety equipment in conjunction with all components can be verified.

Possible procedure for recurring checks for discovering dangerous and undetected device failures.

A calibrated sensor simulator (RTD/TC) and a calibrated digital multimeter are necessary for checking the measuring transducer.

- Connect the sensor simulator to the input of the measuring transducer using the appropriate connection method.
- Connect the digital multimeter to the output in current measuring mode (20 mA range).

The measuring range limits and intermediate values are specified with the sensor simulator.

The corresponding output values of the measuring transducer must be checked on the digital multimeter.

Line faults (break and short circuit) are to be simulated on the input terminals; the configured residual currents are to be determined on the output.

If the function test result is negative, the measuring transducer must be taken out of operation and the process put into a safe state by other measures.

A1.7 Repair

The devices have a long service life, are protected against malfunctions, and are maintenance-free. However, if a device should fail, send it back to Phoenix Contact immediately. The type of malfunction and possible cause must also be stated.

Please use the original packaging or other suitable safe packaging when sending devices back for repairs or recalibration.

Phoenix Contact GmbH & Co KG
Abteilung Service und Reparatur
Flachsmarktstr. 8
D-32825 Blomberg
GERMANY

A1.8 Standards (SIL 2)

The measuring transducers are developed and tested according to the following standards:

- | | |
|----------------------------|--|
| EN 61508: 2001 | Functional safety of electrical/electronic/programmable electronic safety-related systems |
| EN 61326-1: 2006 | Electrical equipment for measurement, control and laboratory use – EMC requirements |
| IEC 61326-3-2: 2006 | Electrical equipment for measurement, control and laboratory use – EMC requirements – Part 3-2: Immunity requirements for safety-related systems and for equipment intended to perform safety-related functions (functional safety) – Industrial applications with specified electromagnetic environment |

A1.9 Abbreviations

Abbreviation		Meaning
DC _D	Diagnostic Coverage of Dangerous Failures	Diagnostic coverage: $DC_D = \lambda_{DD} / (\lambda_{DU} + \lambda_{DD})$
HFT	Hardware Fault Tolerance	Hardware Fault Tolerance: Ability of a function unit to continue with the execution of a demanded function despite existing failures or deviations
λ_D	Rate of Dangerous Failures	Proportion of dangerous failures per hour
λ_{DD}	Rate of Dangerous Detected Failures	Proportion of detected dangerous failures per hour
λ_{DU}	Rate of Dangerous Undetected Failures	Proportion of undetected dangerous failures per hour
λ_S	Rate of Safe Failures	Proportion of safe failures per hour
MTBF	Mean Time Between Failures	Mean time between consecutive failures
PFD _{avg}	Average Probability of Failure on Demand	Average probability of failure on demand of a safety function
PFH	Probability of a Dangerous Failure per Hour	Probability of failure per hour for the safety function
SFF	Safe Failure Fraction	Proportion of safe failures: Proportion of failures without the potential to set the safety-related system to a dangerous or impermissible function state
SIL	Safety Integrity Level	International standard IEC 61508 defines four discrete safety integrity levels (SIL 1 to 4). Each level corresponds to a probability range for the failure of a safety function. The higher the safety integrity level of safety-related systems, the lower the probability that the demanded safety functions will not be performed.