

Technical Chip Distributor for ADI Die Products

Application Support

- Design Assistance
- Assembly Assistance
- Die handling consultancy
- Hi-Rel die qualification
- Hot & Cold die probing
- Electrical test & trimming

Distributed Product Support

- Customised Pack Sizes / Qtys
- Support for all industry recognised supply formats:
 - Waffle Pack
 - Gel Pak
 - Tape & Reel
- Onsite storage, stockholding & scheduling

Product Quality Assurance

- 100% Visual Inspection
 - MIL-STD 883 Condition A
 - MIL-STD 883 Condition A
- On-site failure analysis
- Bespoke 24 Hour monitored storage systems for secure long term product support
- On-site failure analysis

Contact

baredie@micross.com

For price, delivery and to place orders

[HMC424](#)

Analog Devices Welcomes Hittite Microwave Corporation

NO CONTENT ON THE ATTACHED DOCUMENT HAS CHANGED

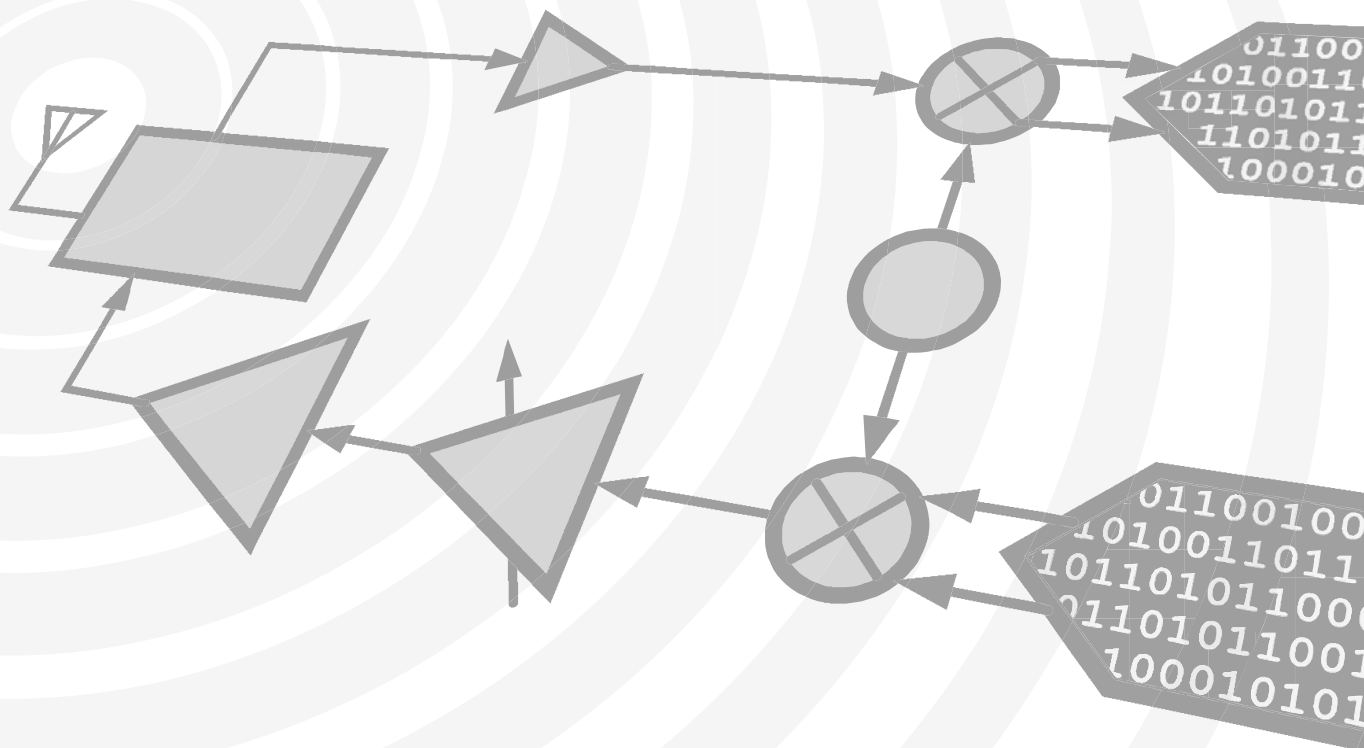

THIS PAGE INTENTIONALLY LEFT BLANK

0.5dB LSB GaAs MMIC 6-BIT DIGITAL ATTENUATOR, DC - 13 GHz

Typical Applications

The HMC424 is ideal for:

- Fiber Optics & Broadband Telecom
- Microwave Radio & VSAT
- Military Radios, Radar & ECM
- Space Applications

Features

- 0.5 dB LSB Steps to 31.5 dB
- Single Control Line Per Bit
- ±0.5 dB Typical Bit Error
- Die Size: 1.45 x 0.85 x 0.1 mm

Functional Diagram

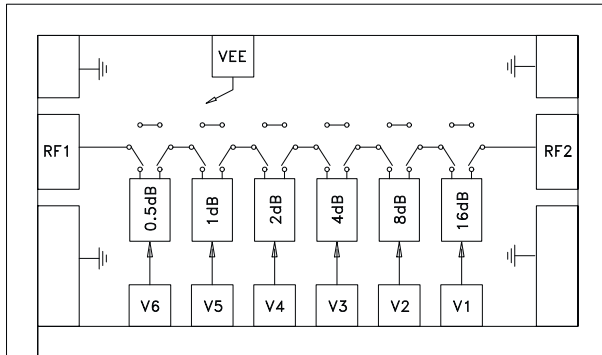

General Description

The HMC424 die is a broadband 6-bit GaAs IC digital attenuator MMIC chip. Covering DC to 13 GHz, the insertion loss is less than 4 dB typical. The attenuator bit values are 0.5 (LSB), 1, 2, 4, 8, and 16 dB for a total attenuation of 31.5 dB. Attenuation accuracy is excellent at ± 0.5 dB typical step error with an IIP3 of +32 dBm. Six control voltage inputs, toggled between 0 and -5V, are used to select each attenuation state. A single Vee bias of -5V allows operation at frequencies down to DC.

Electrical Specifications, $T_A = +25^\circ \text{C}$, With $V_{ee} = -5\text{V}$ & $V_{CTL} = 0/-5\text{V}$

Parameter	Frequency (GHz)	Min.	Typ.	Max.	Units
Insertion Loss	DC - 8.0 GHz		3.0	3.8	dB
	8.0 - 13.0 GHz		4.0	4.6	dB
Attenuation Range	DC - 13.0 GHz		31.5		dB
Return Loss (RF1 & RF2, All Atten. States)	DC - 8.0 GHz	8	12		dB
	8.0 - 13.0 GHz	11	15		dB
Attenuation Accuracy: (Referenced to Insertion Loss)	0.5 - 7.5 dB States	± 0.3 + 4% of Atten. Setting Max			dB
	8 - 31.5 dB States	± 0.3 + 6% of Atten. Setting Max			dB
Input Power for 0.1 dB Compression	1.0 - 13.0 GHz		22		dBm
Input Third Order Intercept Point (Two-Tone Input Power= 0 dBm Each Tone)	1.0 - 13.0 GHz	REF State	46		dBm
		All Other States	32		dBm
Switching Characteristics	DC - 13.0 GHz	tRISE, tFALL (10/90% RF)	30		ns
		tON/tOFF (50% CTL to 10/90% RF)	50		ns

0.5dB LSB GaAs MMIC 6-BIT DIGITAL ATTENUATOR, DC - 13 GHz

Insertion Loss

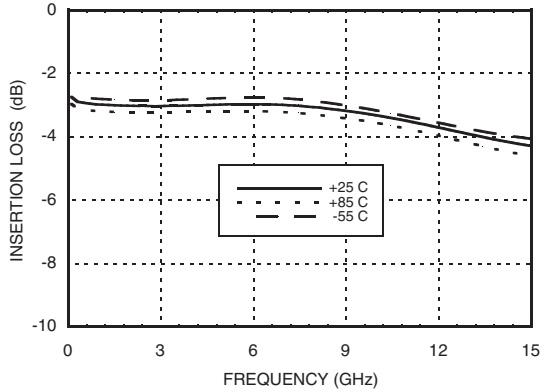

Return Loss RF1, RF2
(Only Major States are Shown)

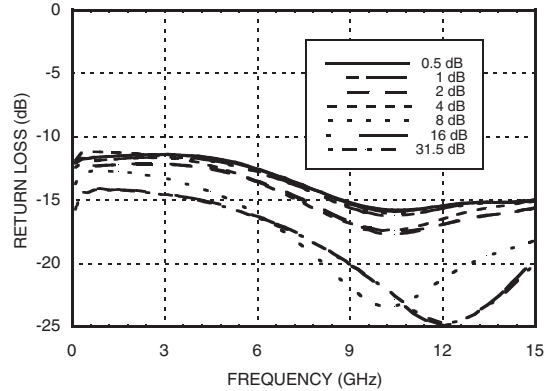

Normalized Attenuation
(Only Major States are Shown)

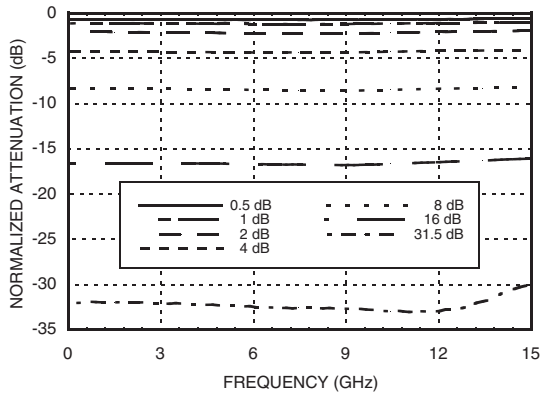

Bit Error vs. Attenuation State

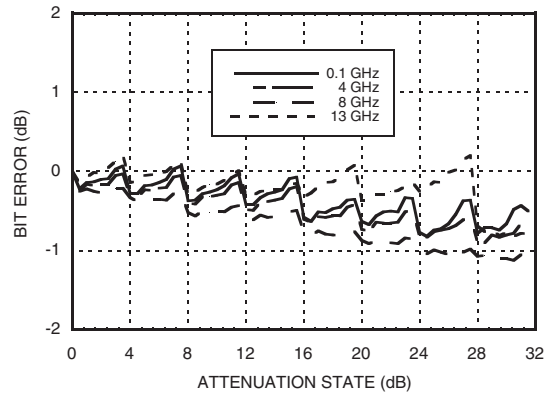

Bit Error vs. Frequency
(Only Major States are Shown)

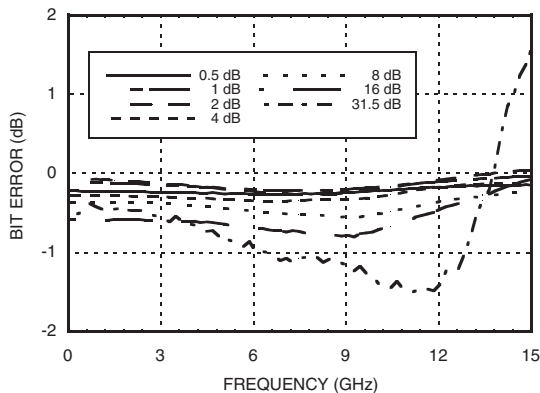

Relative Phase vs. Frequency
(Only Major States are Shown)

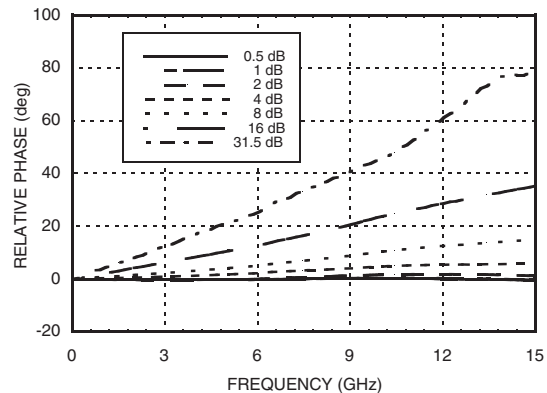

0.5dB LSB GaAs MMIC 6-BIT DIGITAL ATTENUATOR, DC - 13 GHz

1

ATTENUATORS - DIGITAL - CHIP

Worst Case Step Error Between Successive Attenuation States

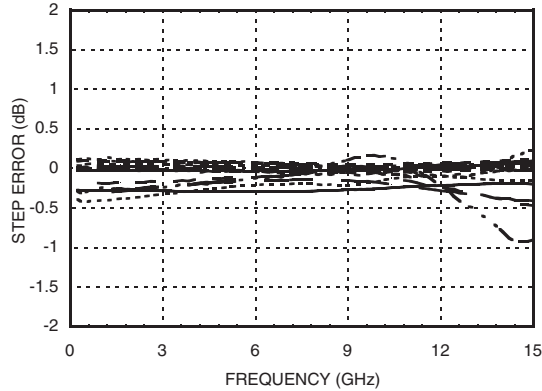

Bias Voltage & Current

Vee Range= -5 Vdc ± 10%		
Vee (Vdc)	Iee (Typ.) (mA)	Iee (Max.) (mA)
-5	2	5

Control Voltage

State	Bias Condition
Low	0 to -3V @ 35 µA Typ.
High	Vee to Vee +0.8V @ 5 µA Typ.

Truth Table

Control Voltage Input						Attenuation State RF1 - RF2
V1 16 dB	V2 8 dB	V3 4 dB	V4 2 dB	V5 1 dB	V6 0.5 dB	
Low	Low	Low	Low	Low	Low	Reference I.L.
Low	Low	Low	Low	Low	High	0.5 dB
Low	Low	Low	Low	High	Low	1 dB
Low	Low	Low	High	Low	Low	2 dB
Low	Low	High	Low	Low	Low	4 dB
Low	High	Low	Low	Low	Low	8 dB
High	Low	Low	Low	Low	Low	16 dB
High	High	High	High	High	High	31.5 dB

Any Combination of the above states will provide an attenuation approximately equal to the sum of the bits selected.

Absolute Maximum Ratings

Control Voltage (V1 to V6)	Vee - 0.5 Vdc
Bias Voltage (Vee)	-7 Vdc
Channel Temperature	150 °C
Thermal Resistance	330 °C/W
Storage Temperature	-65 to + 150 °C
Operating Temperature	-55 to +85 °C
RF Input Power (0.5 - 13 GHz)	+25 dBm



ELECTROSTATIC SENSITIVE DEVICE
OBSERVE HANDLING PRECAUTIONS

Die Packaging Information [1]

Standard	Alternate
WP-8 (Waffle Pack)	[2]

[1] Refer to the "Packaging Information" section for die packaging dimensions.

[2] For alternate packaging information contact Hittite Microwave Corporation.

**0.5dB LSB GaAs MMIC 6-BIT DIGITAL
ATTENUATOR, DC - 13 GHz**

Outline Drawing

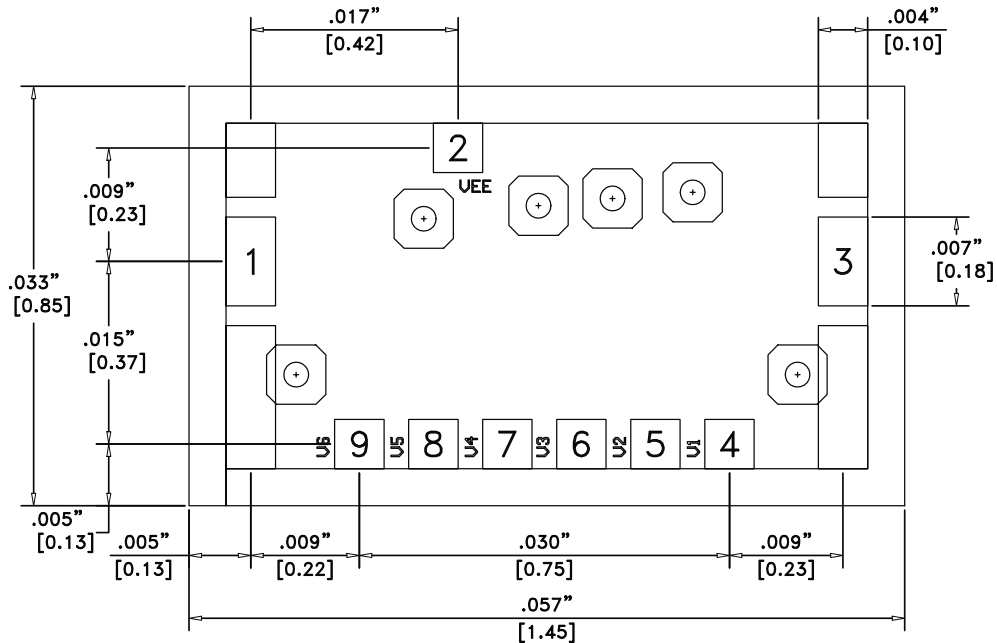

1. ALL DIMENSIONS ARE IN INCHES (MILLIMETERS).
2. TYPICAL BOND PAD IS .004" SQUARE.
3. TYPICAL BOND PAD SPACING IS .006" CENTER TO CENTER EXCEPT AS NOTED.
4. BACKSIDE METALIZATION: GOLD
5. BACKSIDE METAL IS GROUND
6. BOND PAD METALIZATION: GOLD

Pad Descriptions

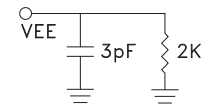
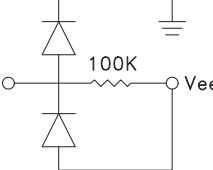
Pad Number	Function	Description	Interface Schematic
	GND	Die bottom must be connected to RF ground.	
1, 3	RF1, RF2	This pad is DC coupled and matched to 50 Ohm. Blocking capacitors are required if RF line potential is not equal to 0V.	
2	VEE	Supply Voltage -5V ± 10%	
4, 5, 6, 7, 8, 9	V1 - V6	See truth table and control voltage table.	

0.5dB LSB GaAs MMIC 6-BIT DIGITAL ATTENUATOR, DC - 13 GHz

1

ATTENUATORS - DIGITAL - CHIP

Suggested Driver Circuit (One Circuit Required Per Bit Control Input)

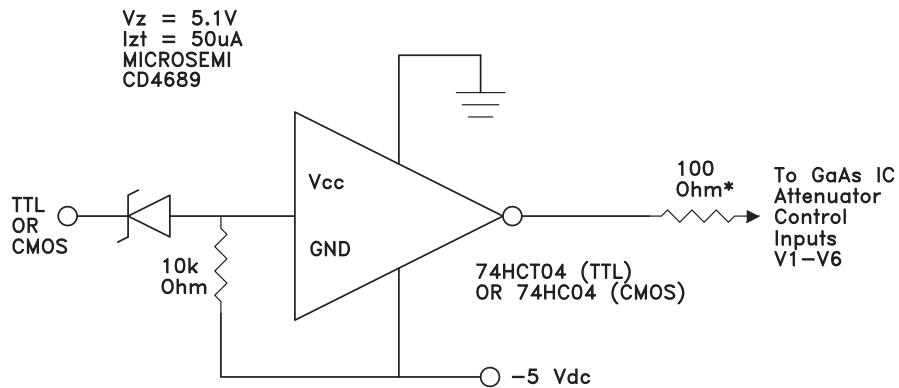

Simple driver using inexpensive standard logic ICs provides fast switching using minimum DC current.
* Recommended value to suppress unwanted RF signals at V1 - V6 control lines.

Assembly Diagram

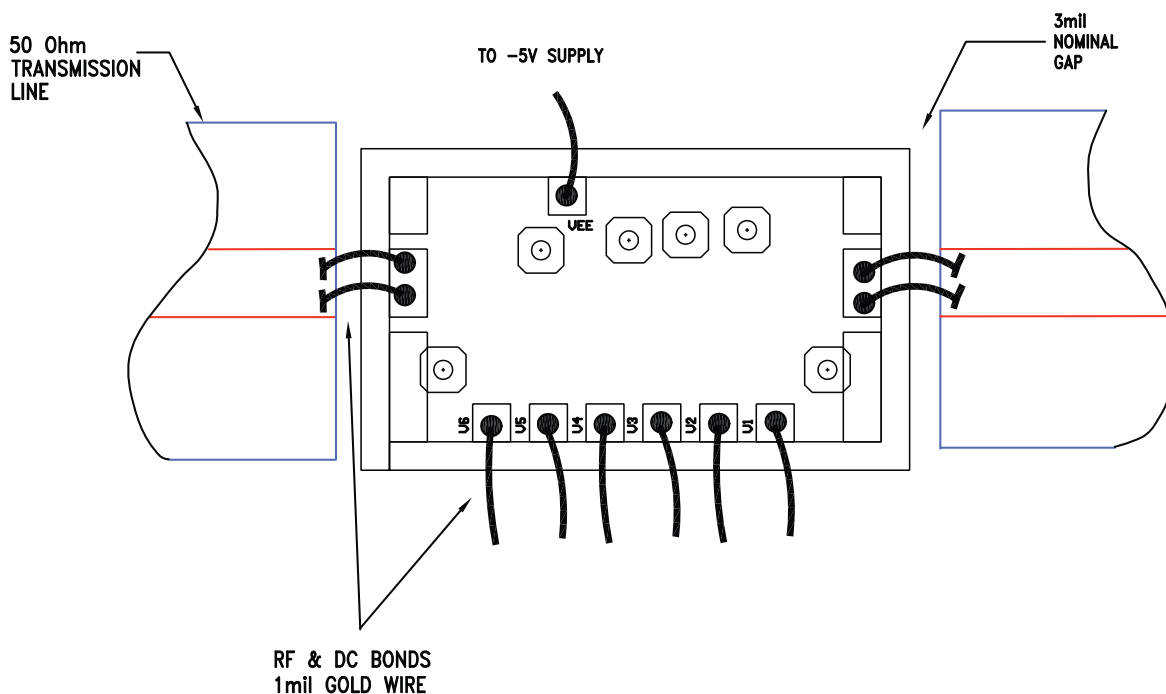

**0.5dB LSB GaAs MMIC 6-BIT DIGITAL
ATTENUATOR, DC - 13 GHz**

Mounting & Bonding Techniques for Millimeterwave GaAs MMICs

The die should be attached directly to the ground plane eutectically or with conductive epoxy (see HMC general Handling, Mounting, Bonding Note).

50 Ohm Microstrip transmission lines on 0.127mm (5 mil) thick alumina thin film substrates are recommended for bringing RF to and from the chip (Figure 1). If 0.254mm (10 mil) thick alumina thin film substrates must be used, the die should be raised 0.150mm (6 mils) so that the surface of the die is coplanar with the surface of the substrate. One way to accomplish this is to attach the 0.102mm (4 mil) thick die to a 0.150mm (6 mil) thick molybdenum heat spreader (moly-tab) which is then attached to the ground plane (Figure 2).

Microstrip substrates should be brought as close to the die as possible in order to minimize bond wire length. Typical die-to-substrate spacing is 0.076mm to 0.152 mm (3 to 6 mils).

Handling Precautions

Follow these precautions to avoid permanent damage.

Storage: All bare die are placed in either Waffle or Gel based ESD protective containers, and then sealed in an ESD protective bag for shipment. Once the sealed ESD protective bag has been opened, all die should be stored in a dry nitrogen environment.

Cleanliness: Handle the chips in a clean environment. DO NOT attempt to clean the chip using liquid cleaning systems.

Static Sensitivity: Follow ESD precautions to protect against ESD strikes.

Transients: Suppress instrument and bias supply transients while bias is applied. Use shielded signal and bias cables to minimize inductive pick-up.

General Handling: Handle the chip along the edges with a vacuum collet or with a sharp pair of bent tweezers. The surface of the chip has fragile air bridges and should not be touched with vacuum collet, tweezers, or fingers.

Mounting

The chip is back-metallized and can be die mounted with AuSn eutectic preforms or with electrically conductive epoxy. The mounting surface should be clean and flat.

Eutectic Die Attach: A 80/20 gold tin preform is recommended with a work surface temperature of 255 °C and a tool temperature of 265 °C. When hot 90/10 nitrogen/hydrogen gas is applied, tool tip temperature should be 290 °C. DO NOT expose the chip to a temperature greater than 320 °C for more than 20 seconds. No more than 3 seconds of scrubbing should be required for attachment.

Epoxy Die Attach: Apply a minimum amount of epoxy to the mounting surface so that a thin epoxy fillet is observed around the perimeter of the chip once it is placed into position. Cure epoxy per the manufacturer's schedule.

Wire Bonding

Ball or wedge bond with 0.025mm (1 mil) diameter pure gold wire. Thermosonic wirebonding with a nominal stage temperature of 150 °C and a ball bonding force of 40 to 50 grams or wedge bonding force of 18 to 22 grams is recommended. Use the minimum level of ultrasonic energy to achieve reliable wirebonds. Wirebonds should be started on the chip and terminated on the package or substrate. All bonds should be as short as possible <0.31mm (12 mils).

