



IMP12-1B5PSVC0D

IMP

INDUCTIVE PROXIMITY SENSORS

SICK
Sensor Intelligence.



Illustration may differ



Ordering information

Type	Part no.
IMP12-1B5PSVCOD	6050125

Other models and accessories → www.sick.com/IMP

Detailed technical data

Features

Housing	Cylindrical thread design
Thread size	M12 1
Diameter	Ø 12 mm
Pressure resistance	≤ 500 bar
Sensing range S_n	1.5 mm
Safe sensing range S_a	1.2 mm
Installation type	Flush
Switching frequency	600 Hz
Connection type	Male connector M12, 4-pin
Switching output	PNP
Output function	NO
Electrical wiring	DC 3-wire
Enclosure rating	IP68 ¹⁾
Special features	High pressure resistant

¹⁾ Sensing face.

Mechanics/electronics

Supply voltage	10 V DC ... 30 V DC
Ripple	≤ 20 % ¹⁾
Voltage drop	≤ 2 V ²⁾
Current consumption	≤ 10 mA ³⁾

¹⁾ Of V_S.

²⁾ With I_a = 200 mA.

³⁾ Without load.

⁴⁾ Typ. 8%.

⁵⁾ U_b = 20 ... 30 VDC.

⁶⁾ T_a = 23 °C ± 5 °C.

⁷⁾ Front.

Time delay before availability	≤ 50 ms
Hysteresis	1 % ... 15 % ⁴⁾
Reproducibility	≤ 7 % ^{5) 6)}
Temperature drift (of S_r)	≤ 15 %
EMC	According to EN 60947-5-2
Continuous current I_a	≤ 200 mA
Vacuum resistance	10 ⁻⁸ Torr ⁷⁾
Large sealing ring	5.3 mm x 2.4 mm
Size support ring	10 mm x 5.9 mm x 1 mm
Short-circuit protection	✓
Reverse polarity protection	✓
Shock and vibration resistance	30 g, 11 ms / 10 ... 55 Hz, 1 mm
Ambient operating temperature	-25 °C ... +80 °C
Housing material	Stainless steel, V2A
Sensing face material	Ceramics, ceramics
Sealing ring material	FPM
Housing length	78 mm
Thread length	42 mm
Tightening torque, max.	≤ 40 Nm

¹⁾ Of V_S.

²⁾ With I_a = 200 mA.

³⁾ Without load.

⁴⁾ Typ. 8%.

⁵⁾ U_b = 20 ... 30 VDC.

⁶⁾ T_a = 23 °C ± 5 °C.

⁷⁾ Front.

Reduction factors

Note	The values are reference values which may vary
St37 steel (Fe)	1
Stainless steel (V2A, 304)	Approx. 0.75
Aluminum (Al)	Approx. 0.2
Copper (Cu)	Approx. 0.12
Brass (Br)	Approx. 0.34

Installation note

Remark	Associated graphic see "Installation"
---------------	---------------------------------------

Classifications

ECl@ss 5.0	27270101
ECl@ss 5.1.4	27270101
ECl@ss 6.0	27270101
ECl@ss 6.2	27270101
ECl@ss 7.0	27270101
ECl@ss 8.0	27270101

ECl@ss 8.1	27270101
ECl@ss 9.0	27270101
ETIM 5.0	EC002714
ETIM 6.0	EC002714
UNSPSC 16.0901	39122230

Installation note

Flush installation

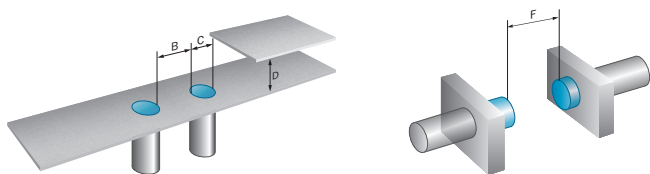

Connection diagram

cd-007

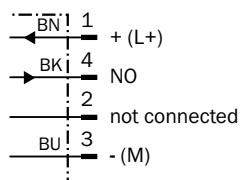

Dimensional drawing (Dimensions in mm (inch))



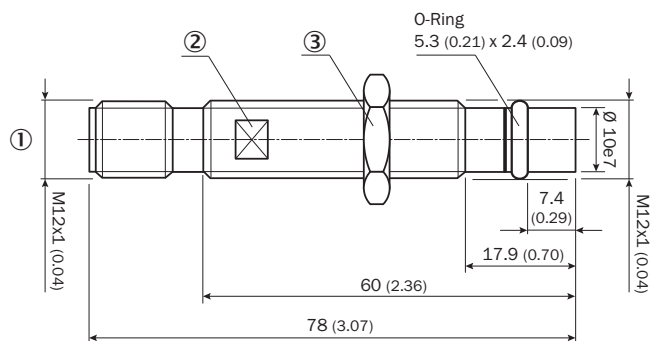

IMP12-xxxxxxxD, 78 mm



- ① Male connector M12, 4-pin
- ② Width across 10
- ③ Width across 17

Recommended accessories

Other models and accessories → www.sick.com/IMP

	Brief description	Type	Part no.
Other mounting accessories			
		O-ring IMP12	5327494
		Support ring IMP12	5327496
Plug connectors and cables			
	Head A: female connector, M12, 4-pin, straight, A-coded Head B: open cable ends Cable: Sensor/actuator cable, PUR, halogen-free, unshielded, 2 m	YF2A14-020UB3XLEAX	2095607
	Head A: female connector, M12, 4-pin, straight, A-coded Head B: open cable ends Cable: Sensor/actuator cable, PVC, unshielded, 2 m	YF2A14-020VB3XLEAX	2096234
	Head A: female connector, M12, 4-pin, straight, A-coded Head B: open cable ends Cable: Sensor/actuator cable, PUR, halogen-free, unshielded, 5 m	YF2A14-050UB3XLEAX	2095608
	Head A: female connector, M12, 4-pin, straight, A-coded Head B: open cable ends Cable: Sensor/actuator cable, PVC, unshielded, 5 m	YF2A14-050VB3XLEAX	2096235
	Head A: female connector, M12, 4-pin, angled, A-coded Head B: open cable ends Cable: Sensor/actuator cable, PUR, halogen-free, unshielded, 2 m	YG2A14-020UB3XLEAX	2095766
	Head A: female connector, M12, 4-pin, angled, A-coded Head B: open cable ends Cable: Sensor/actuator cable, PVC, unshielded, 2 m	YG2A14-020VB3XLEAX	2095895
	Head A: female connector, M12, 4-pin, angled, A-coded Head B: open cable ends Cable: Sensor/actuator cable, PUR, halogen-free, unshielded, 5 m	YG2A14-050UB3XLEAX	2095767
	Head A: female connector, M12, 4-pin, angled, A-coded Head B: open cable ends Cable: Sensor/actuator cable, PVC, unshielded, 5 m	YG2A14-050VB3XLEAX	2095897

SICK AT A GLANCE

SICK is one of the leading manufacturers of intelligent sensors and sensor solutions for industrial applications. A unique range of products and services creates the perfect basis for controlling processes securely and efficiently, protecting individuals from accidents and preventing damage to the environment.

We have extensive experience in a wide range of industries and understand their processes and requirements. With intelligent sensors, we can deliver exactly what our customers need. In application centers in Europe, Asia and North America, system solutions are tested and optimized in accordance with customer specifications. All this makes us a reliable supplier and development partner.

Comprehensive services complete our offering: SICK LifeTime Services provide support throughout the machine life cycle and ensure safety and productivity.

For us, that is “Sensor Intelligence.”

WORLDWIDE PRESENCE:

Contacts and other locations –www.sick.com