

# TrenchMV™ IXTC160N10T

## Power MOSFET

(Electrically Isolated Back Surface)

$$V_{DSS} = 100 \text{ V}$$

$$I_{D25} = 83 \text{ A}$$

$$R_{DS(on)} \leq 7.5 \text{ m}\Omega$$

N-Channel Enhancement Mode  
Avalanche Rated



Symbol	Test Conditions	Maximum Ratings	
$V_{DSS}$	$T_J = 25^\circ\text{C}$ to $175^\circ\text{C}$	100	V
$V_{DGR}$	$T_J = 25^\circ\text{C}$ to $175^\circ\text{C}$ ; $R_{GS} = 1 \text{ M}\Omega$	100	V
$V_{GSM}$	Transient	$\pm 20$	V
$I_{D25}$	$T_C = 25^\circ\text{C}$	83	A
$I_L$	Package Current Limit, RMS	75	A
$I_{DM}$	$T_C = 25^\circ\text{C}$ , pulse width limited by $T_{JM}$	430	A
$I_{AR}$	$T_C = 25^\circ\text{C}$	25	A
$E_{AS}$	$T_C = 25^\circ\text{C}$	500	mJ
$dv/dt$	$I_S \leq I_{DM}$ , $di/dt \leq 100 \text{ A}/\mu\text{s}$ , $V_{DD} \leq V_{DSS}$ $T_J \leq 175^\circ\text{C}$ , $R_G = 5 \Omega$	3	V/ns
$P_D$	$T_C = 25^\circ\text{C}$	140	W
$T_J$		-55 ... +175	$^\circ\text{C}$
$T_{JM}$		175	$^\circ\text{C}$
$T_{stg}$		-55 ... +175	$^\circ\text{C}$
$T_L$	1.6 mm (0.062 in.) from case for 10 s	300	$^\circ\text{C}$
$T_{SOLD}$	Plastic body for 10 seconds	260	$^\circ\text{C}$
$V_{ISOL}$	50/60 Hz, $t = 1$ minute, $I_{ISOL} < 1 \text{ mA}$ , RMS	2500	V
$F_C$	Mounting force	11..65/2.5..15	N/lb.
<b>Weight</b>		2	g

ISOPLUS220 (IXTC)  
E153432

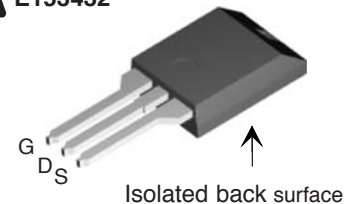

G = Gate  
S = Source  
D = Drain

### Features

- Ultra-low On Resistance
- Unclamped Inductive Switching (UIS) rated
- Low package inductance
  - easy to drive and to protect
- 175  $^\circ\text{C}$  Operating Temperature

### Advantages

- Easy to mount
- Space savings
- High power density

### Applications

- Automotive
  - Motor Drives
  - 42V Power Bus
  - ABS Systems
- DC/DC Converters and Off-line UPS
- Primary Switch for 24V and 48V Systems
- Distributed Power Architectures and VRMs
- Electronic Valve Train Systems
- High Current Switching Applications
- High Voltage Synchronous Rectifier

Symbol	Test Conditions ( $T_J = 25^\circ\text{C}$ unless otherwise specified)	Characteristic Values		
		Min.	Typ.	Max.
$BV_{DSS}$	$V_{GS} = 0 \text{ V}$ , $I_D = 250 \mu\text{A}$	100		V
$V_{GS(th)}$	$V_{DS} = V_{GS}$ , $I_D = 250 \mu\text{A}$	2.5		4.5 V
$I_{GSS}$	$V_{GS} = \pm 20 \text{ V}$ , $V_{DS} = 0 \text{ V}$			$\pm 200 \text{ nA}$
$I_{DSS}$	$V_{DS} = V_{DSS}$ $V_{GS} = 0 \text{ V}$ $T_J = 150^\circ\text{C}$			5 $\mu\text{A}$ 250 $\mu\text{A}$
$R_{DS(on)}$	$V_{GS} = 10 \text{ V}$ , $I_D = 25 \text{ A}$ , Notes 1, 2	6.5		7.5 $\text{m}\Omega$

Symbol	Test Conditions	Characteristic Values ( $T_J = 25^\circ\text{C}$ unless otherwise specified)		
		Min.	Typ.	Max.
$g_{fs}$	$V_{DS} = 10\text{ V}; I_D = 60\text{ A}$ , Note 1	65	102	S
$C_{iss}$	$V_{GS} = 0\text{ V}, V_{DS} = 25\text{ V}, f = 1\text{ MHz}$		6600	pF
$C_{oss}$		880	pF	
$C_{rss}$		135	pF	
$t_{d(on)}$	$V_{GS} = 10\text{ V}, V_{DS} = 0.5 V_{DSS}, I_D = 25\text{ A}$ $R_G = 5\ \Omega$ (External)		33	ns
$t_r$		61	ns	
$t_{d(off)}$		49	ns	
$t_f$		42	ns	
$Q_{g(on)}$	$V_{GS} = 10\text{ V}, V_{DS} = 0.5 V_{DSS}, I_D = 25\text{ A}$		132	nC
$Q_{gs}$		37	nC	
$Q_{gd}$		40	nC	
$R_{thJC}$				$1.06^\circ\text{C/W}$
$R_{thCS}$		0.5		$^\circ\text{C/W}$

### Source-Drain Diode

Symbol	Test Conditions	Characteristic Values ( $T_J = 25^\circ\text{C}$ unless otherwise specified)		
		Min.	Typ.	Max.
$I_S$	$V_{GS} = 0\text{ V}$			160 A
$I_{SM}$	Pulse width limited by $T_{JM}$			430 A
$V_{SD}$	$I_F = 25\text{ A}, V_{GS} = 0\text{ V}$ , Note 1			1.0 V
$t_{rr}$	$I_F = 25\text{ A}, -di/dt = 100\text{ A}/\mu\text{s}$ $V_R = 30\text{ V}, V_{GS} = 0\text{ V}$		60	ns

- Notes: 1. Pulse test:  $t \leq 300\ \mu\text{s}$ , duty cycle  $d \leq 2\%$ ;  
2. Drain and Source Kelvin contacts must be located less than 5 mm from the plastic body.

### ISOPLUS220 (IXTC) Outline

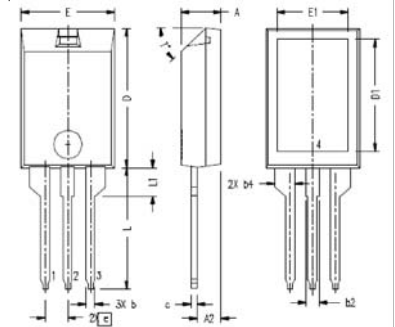

1. Gate 2. Drain  
3. Source

Note: Bottom heatsink (Pin 4) is electrically isolated from Pins 1, 2, and 3.

SYM	INCHES		MILLIMETERS	
	MIN	MAX	MIN	MAX
A	.157	.197	4.00	5.00
A2	.098	.118	2.50	3.00
b	.035	.051	0.90	1.30
b2	.049	.065	1.25	1.65
b4	.093	.100	2.35	2.55
c	.028	.039	0.70	1.00
D	.591	.630	15.00	16.00
D1	.472	.512	12.00	13.00
E	.394	.433	10.00	11.00
E1	.295	.335	7.50	8.50
e	.100	BASIC	2.55	BASIC
L	.512	.571	13.00	14.50
L1	.118	.138	3.00	3.50
T*			42.5*	47.5*

### PRELIMINARY TECHNICAL INFORMATION

The product presented herein is under development. The Technical Specifications offered are derived from data gathered during objective characterizations of preliminary engineering lots; but also may yet contain some information supplied during a pre-production design evaluation. IXYS reserves the right to change limits, test conditions, and dimensions without notice.

IXYS reserves the right to change limits, test conditions, and dimensions.

IXYS MOSFETs and IGBTs are covered by one or more of the following U.S. patents:	4,835,592	4,931,844	5,049,961	5,237,481	6,162,665	6,404,065 B1	6,683,344	6,727,585	7,005,734 B2
	4,850,072	5,017,508	5,063,307	5,381,025	6,259,123 B1	6,534,343	6,710,405 B2	6,759,692	7,063,975 B2
	4,881,106	5,034,796	5,187,117	5,486,715	6,306,728 B1	6,583,505	6,710,463	6,771,478 B2	7,071,537

**Fig. 1. Output Characteristics @ 25°C**

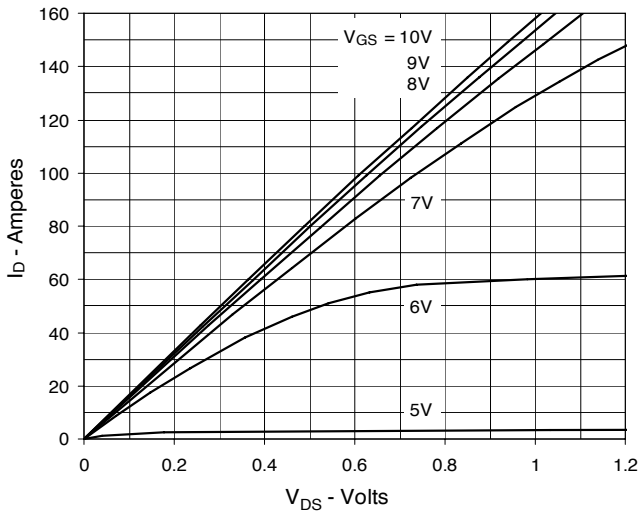

**Fig. 2. Extended Output Characteristics @ 25°C**

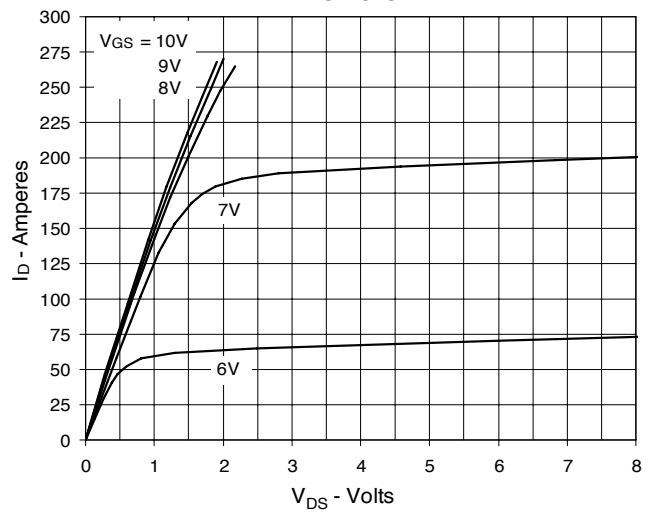

**Fig. 3. Output Characteristics @ 150°C**

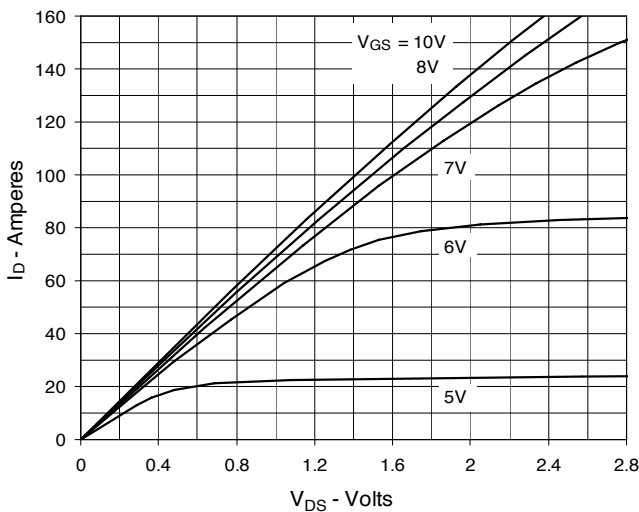

**Fig. 4.  $R_{DS(on)}$  Normalized to  $I_D = 160A$  Value vs. Junction Temperature**

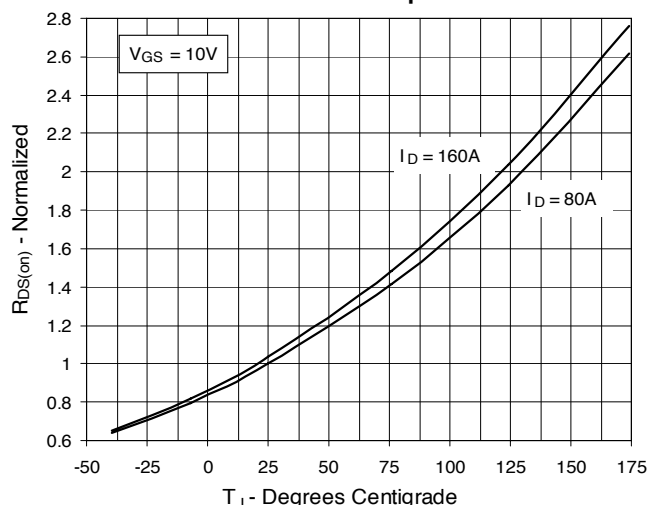

**Fig. 5.  $R_{DS(on)}$  Normalized to  $I_D = 80A$  Value vs. Drain Current**

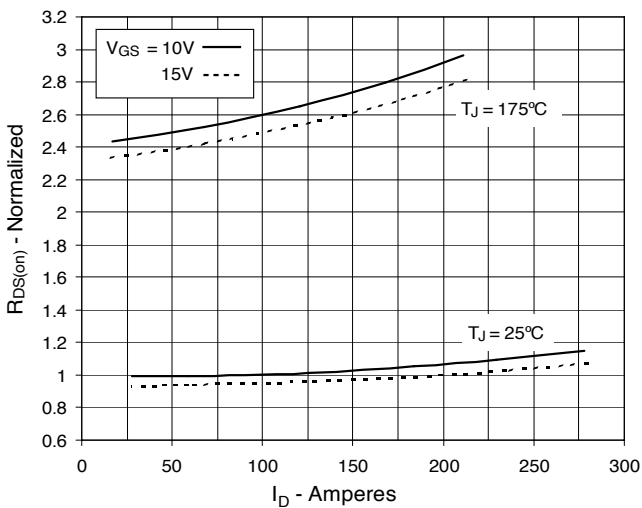

**Fig. 6. Drain Current vs. Case Temperature**

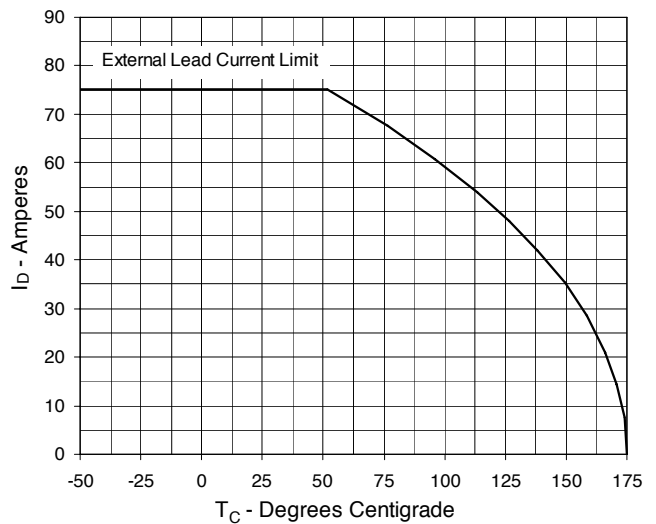

**Fig. 7. Input Admittance**

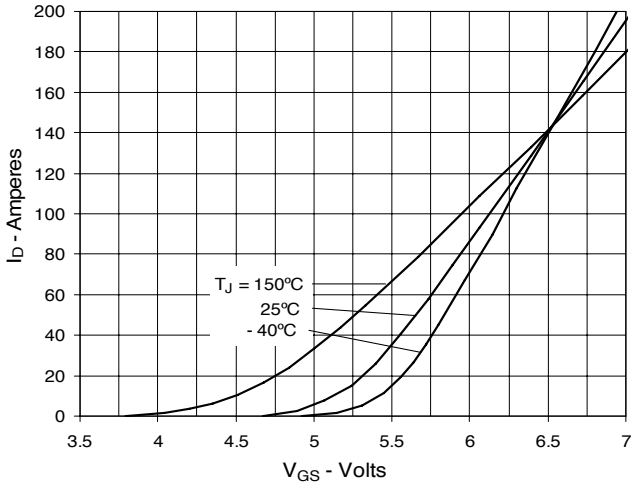

**Fig. 8. Transconductance**

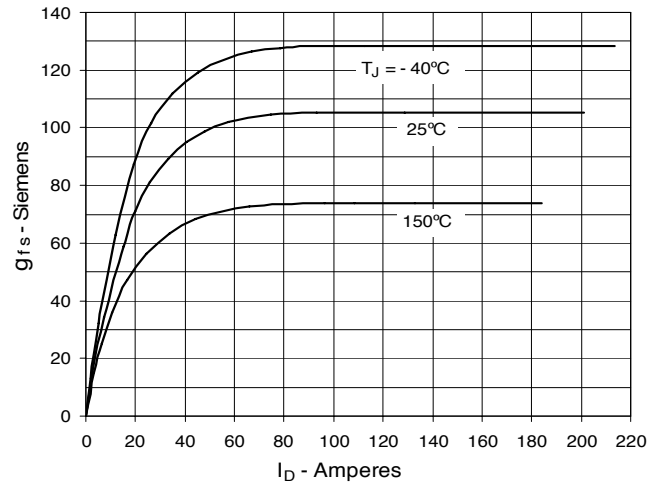

**Fig. 9. Forward Voltage Drop of Intrinsic Diode**

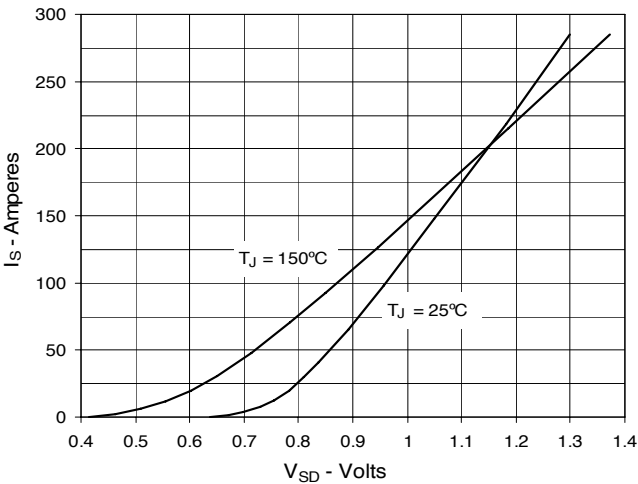

**Fig. 10. Gate Charge**

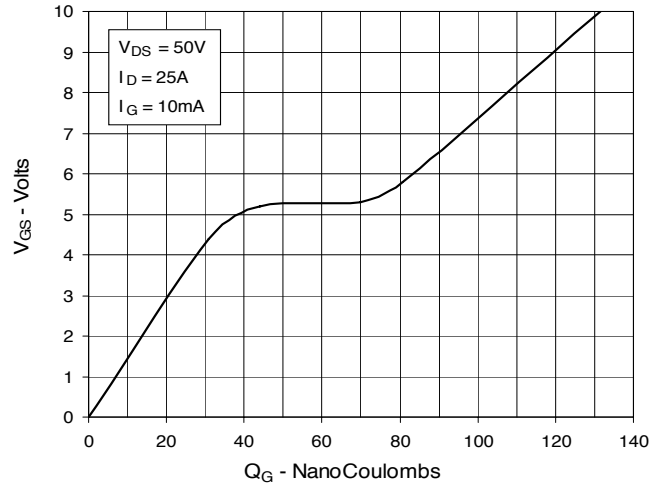

**Fig. 11. Capacitance**

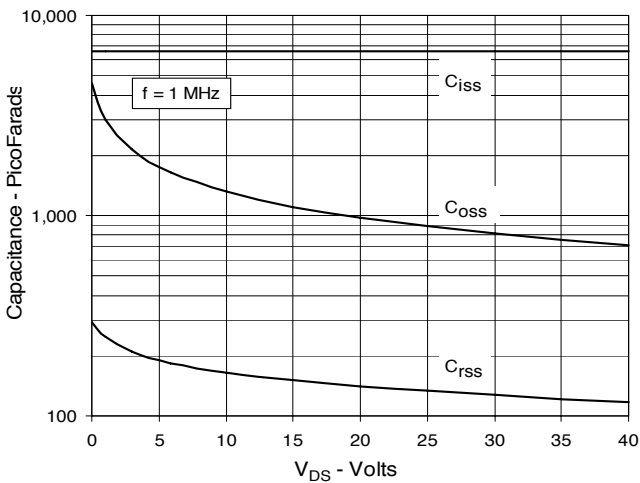

**Fig. 12. Maximum Transient Thermal Impedance**

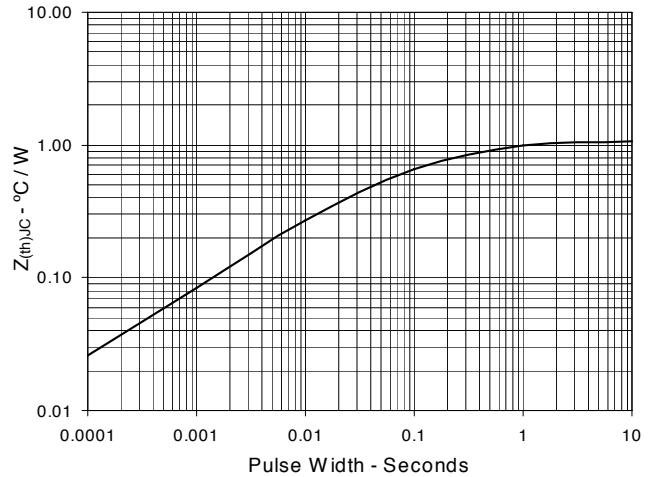

**Fig. 13. Resistive Turn-on  
Rise Time vs. Junction Temperature**

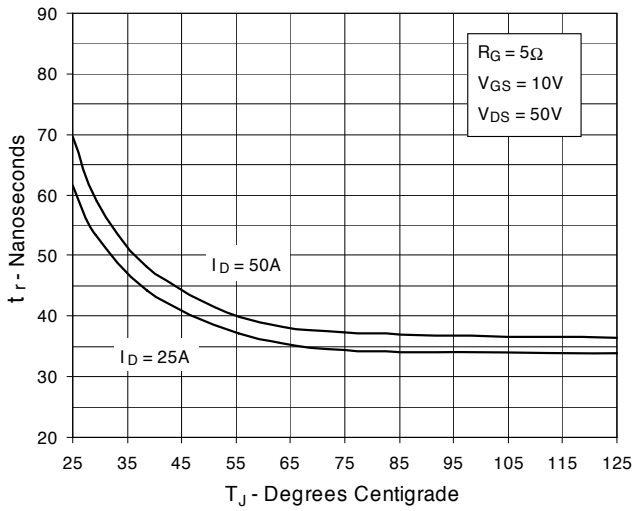

**Fig. 14. Resistive Turn-on  
Rise Time vs. Drain Current**

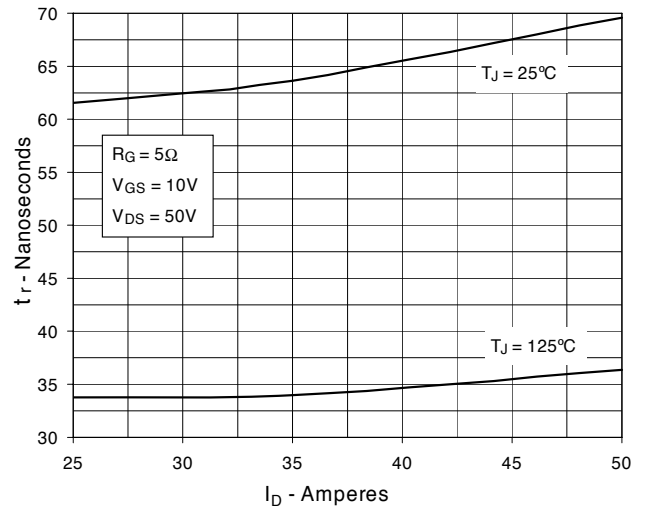

**Fig. 15. Resistive Turn-on  
Switching Times vs. Gate Resistance**

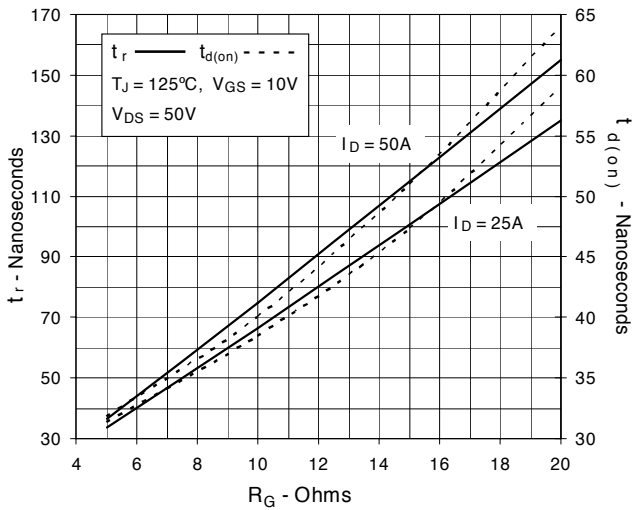

**Fig. 16. Resistive Turn-off  
Switching Times vs. Junction Temperature**

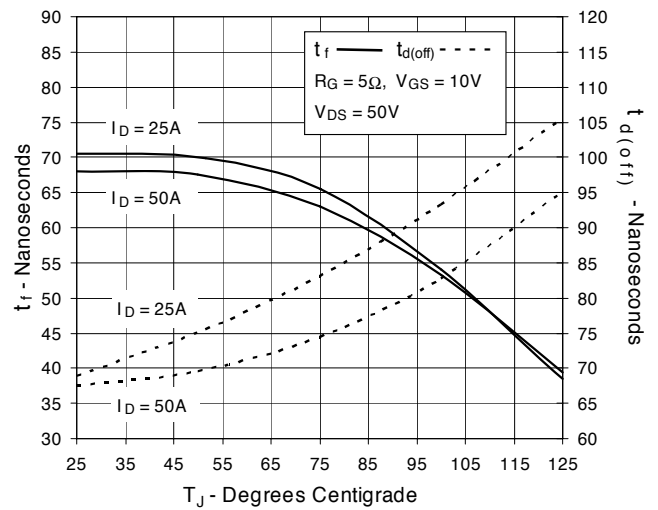

**Fig. 17. Resistive Turn-off  
Switching Times vs. Drain Current**

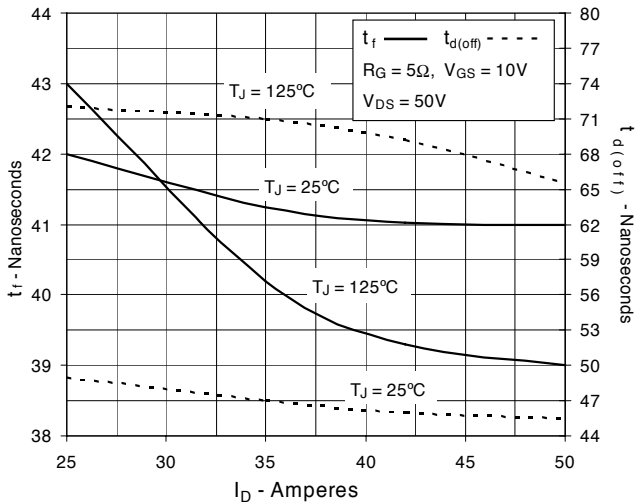

**Fig. 18. Resistive Turn-off  
Switching Times vs. Gate Resistance**

