

FlipKY[®], Chip Scale Package Schottky Barrier Rectifier, 0.5 A

 FlipKY[®]
FEATURES

- Ultra low V_F to footprint area
- Very low profile (< 0.6 mm)
- Low thermal resistance
- Supplied tested and on tape and reel
- Compliant to RoHS Directive 2002/95/EC

RoHS
COMPLIANT

APPLICATIONS

- Reverse polarity protection
- Current steering
- Freewheeling
- Flyback
- Oring

DESCRIPTION

Vishay's FlipKY[®] product family utilizes wafer level chip scale packaging to deliver Schottky diodes with the lowest V_F to PCB footprint area in industry. The three pad 0.9 mm x 1.2 mm devices can deliver up to 0.5 A and occupy only 1.08 mm² of board space. The anode and cathode connections are made through solder bump pads on one side of the silicon enabling designers to strategically place the diodes on the PCB. This design not only minimizes board space but also reduces thermal resistance and inductance, which can improve overall circuit efficiency.

Typical applications include hand-held, portable equipment such as cell phones, MP3 players, bluetooth, GPS, PDAs, and portable hard disk drives where space savings and performance are crucial.

| PRODUCT SUMMARY | |
|-------------------------|------------|
| $I_{F(AV)}$ | 0.5 A |
| V_R | 40 V |
| V_F at I_F | 0.42 V |
| I_{RM} max. at 25 °C | 10 μ A |
| I_{RM} max. at 125 °C | 2 mA |
| T_J max. | 150 °C |
| E_{AS} | 5 mJ |

| MAJOR RATINGS AND CHARACTERISTICS | | | |
|-----------------------------------|-------------------------------|-------------|-------|
| SYMBOL | CHARACTERISTICS | MAX. | UNITS |
| V_{RRM} | | 40 | V |
| $I_{F(AV)}$ | Rectangular waveform | 0.5 | A |
| I_{FSM} | | 190 | |
| V_F | 0.5 A_{pk} , $T_J = 125$ °C | 0.42 | V |
| T_J | | - 55 to 150 | °C |

| VOLTAGE RATINGS | | | |
|--------------------------------------|-----------|----------------|-------|
| PARAMETER | SYMBOL | VS-FCSP05H40TR | UNITS |
| Maximum DC reverse voltage | V_R | 40 | V |
| Maximum working peak reverse voltage | V_{RWM} | | |



| ABSOLUTE MAXIMUM RATINGS | | | | | |
|--|-------------|---|---|--------|-------|
| PARAMETER | SYMBOL | TEST CONDITIONS | | VALUES | UNITS |
| Maximum average forward current | $I_{F(AV)}$ | 50 % duty cycle at $T_{PCB} = 114\text{ °C}$, rectangular waveform | | 0.5 | A |
| Maximum peak one cycle non-repetitive surge current at 25 °C | I_{FSM} | 5 μ s sine or 3 μ s rect. pulse | Following any rated load condition and with rated V_{RRM} applied | 190 | |
| | | 10 ms sine or 6 ms rect. pulse | | 10 | |
| Non-repetitive avalanche energy | E_{AS} | $T_J = 25\text{ °C}$, $I_{AS} = 2.0\text{ A}$, $L = 5.0\text{ mH}$ | | 5 | mJ |
| Repetitive avalanche current | I_{AR} | Current decaying linearly to zero in 1 μ s Frequency limited by T_J maximum $V_A = 1.5 \times V_R$ typical | | 0.5 | A |

| ELECTRICAL SPECIFICATIONS ($T_J = 25\text{ °C}$ unless otherwise specified) | | | | | | |
|--|----------------|---|---------------------------|-------|--------|------------|
| PARAMETER | SYMBOL | TEST CONDITIONS | | TYP. | MAX. | UNITS |
| Maximum forward voltage drop See fig. 1 | $V_{FM}^{(1)}$ | 0.5 A | $T_J = 25\text{ °C}$ | 0.48 | 0.52 | V |
| | | 1 A | | 0.54 | 0.58 | |
| | | 0.5 A | $T_J = 125\text{ °C}$ | 0.38 | 0.42 | |
| | | 1 A | | 0.46 | 0.50 | |
| Maximum reverse leakage current See fig. 2 | $I_{RM}^{(1)}$ | $T_J = 25\text{ °C}$ | $V_R = \text{Rated } V_R$ | 1 | 10 | μ A |
| | | | $V_R = 20\text{ V}$ | 0.2 | 0.5 | |
| | | | $V_R = 10\text{ V}$ | 0.08 | 0.25 | |
| | | | $V_R = 5\text{ V}$ | 0.05 | 0.15 | |
| | | $T_J = 125\text{ °C}$ | $V_R = \text{Rated } V_R$ | 0.5 | 2 | mA |
| | | | $V_R = 20\text{ V}$ | 0.2 | 1 | |
| | | | $V_R = 10\text{ V}$ | 0.15 | 0.8 | |
| | | | $V_R = 5\text{ V}$ | 0.125 | 0.5 | |
| Maximum junction capacitance | C_T | $V_R = 5\text{ V}_{DC}$ (test signal range 100 kHz to 1 MHz), 25 °C | | - | 90 | pF |
| Maximum voltage rate of charge | dV/dt | Rated V_R | | - | 10 000 | V/ μ s |

Note(1) Pulse width < 300 μ s, duty cycle < 2 %

| THERMAL - MECHANICAL SPECIFICATIONS | | | | | |
|---|-------------------------|-----------------|--|-------------|-------|
| PARAMETER | SYMBOL | TEST CONDITIONS | | VALUES | UNITS |
| Maximum junction and storage temperature range | $T_J^{(1)}$, T_{Stg} | | | - 55 to 150 | °C |
| Typical thermal resistance, junction to PCB | $R_{thJL}^{(2)}$ | DC operation | | 35 | °C/W |
| Maximum thermal resistance, junction to ambient | R_{thJA} | | | 150 | |

Notes(1) $\frac{dP_{tot}}{dT_J} < \frac{1}{R_{thJA}}$ thermal runaway condition for a diode on its own heatsink

(2) Mounted on minimum footprint PCB

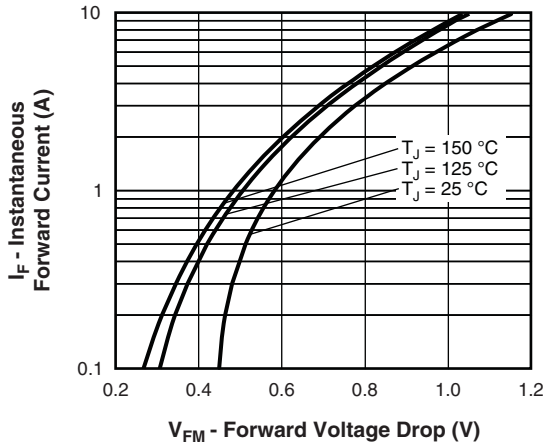

Fig. 1 - Maximum Forward Voltage Drop Characteristics (Per Leg)

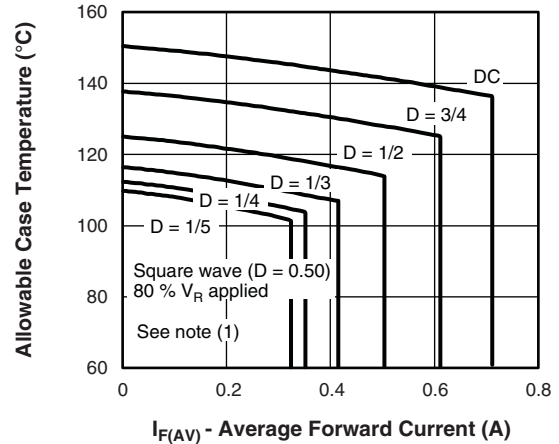

Fig. 4 - Maximum Allowable Case Temperature vs. Average Forward Current (Per Leg)

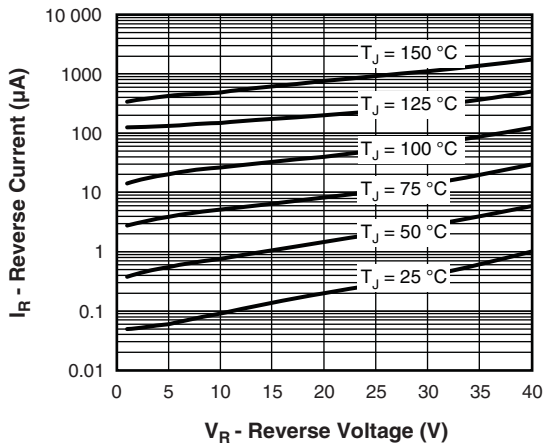

Fig. 2 - Typical Values of Reverse Current vs. Reverse Voltage (Per Leg)

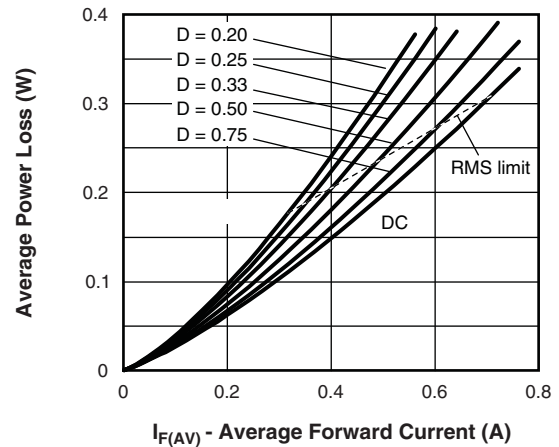

Fig. 5 - Forward Power Loss Characteristics (Per Leg)

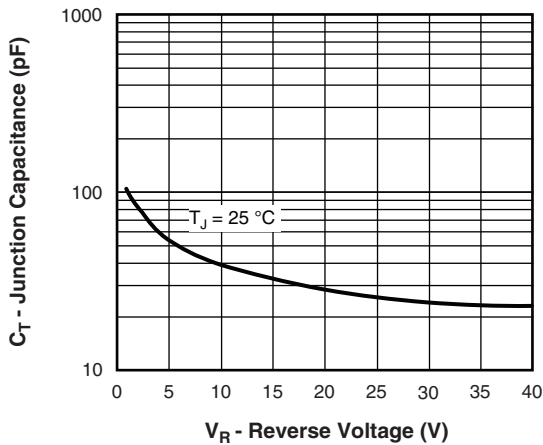

Fig. 3 - Typical Junction Capacitance vs. Reverse Voltage (Per Leg)

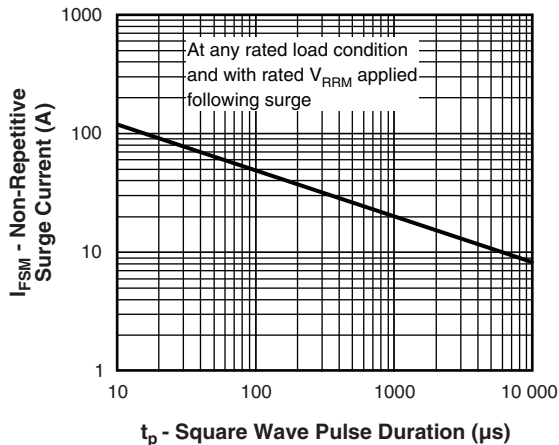

Fig. 6 - Maximum Non-Repetitive Surge Current (Per Leg)

Note

(1) Formula used: $T_C = T_J - (Pd + Pd_{REV}) \times R_{thJC}$;
Pd = Forward power loss = $I_{F(AV)} \times V_{FM}$ at $(I_{F(AV)}/D)$ (see fig. 6); Pd_{REV} = Inverse power loss = $V_{R1} \times I_R (1 - D)$; I_R at 80 % V_R applied

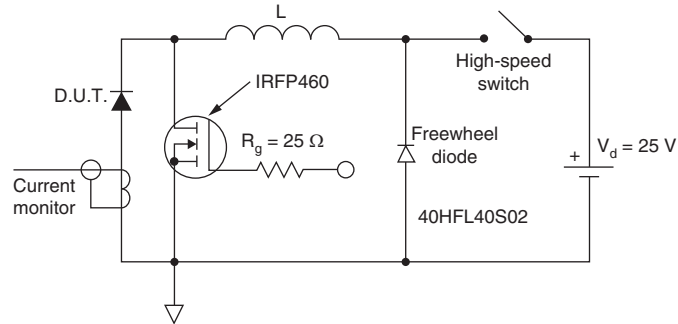

Fig. 7 - Unclamped Inductive Test Circuit

LINKS TO RELATED DOCUMENTS

| LINKS TO RELATED DOCUMENTS | |
|----------------------------|--|
| Dimensions | www.vishay.com/doc?95049 |
| Part marking information | www.vishay.com/doc?95060 |
| Packaging information | www.vishay.com/doc?95062 |
| SPICE model | www.vishay.com/doc?95318 |

FlipKY[®] 0.5 A/0.75 A

DIMENSIONS in millimeters

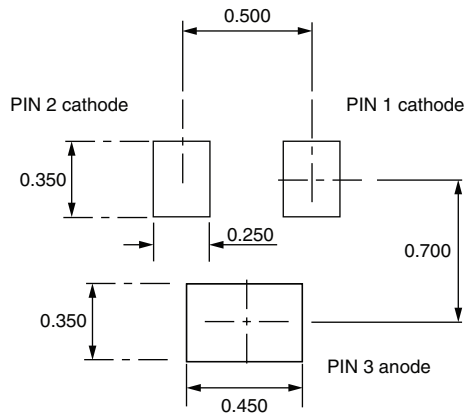
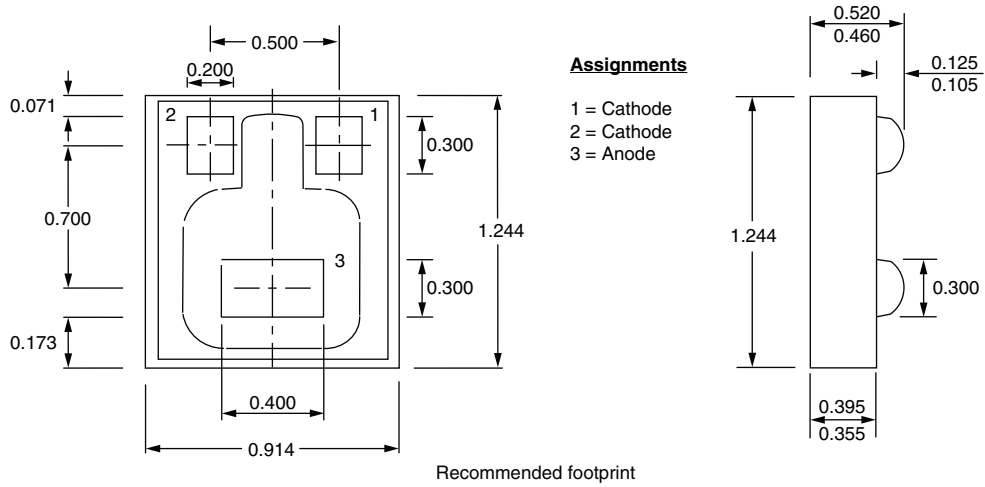

Notes

- Dimensioning and tolerancing per ASME Y14.5M-1994
- Controlling dimension: millimeter



Disclaimer

ALL PRODUCT, PRODUCT SPECIFICATIONS AND DATA ARE SUBJECT TO CHANGE WITHOUT NOTICE TO IMPROVE RELIABILITY, FUNCTION OR DESIGN OR OTHERWISE.

Vishay Intertechnology, Inc., its affiliates, agents, and employees, and all persons acting on its or their behalf (collectively, "Vishay"), disclaim any and all liability for any errors, inaccuracies or incompleteness contained in any datasheet or in any other disclosure relating to any product.

Vishay makes no warranty, representation or guarantee regarding the suitability of the products for any particular purpose or the continuing production of any product. To the maximum extent permitted by applicable law, Vishay disclaims (i) any and all liability arising out of the application or use of any product, (ii) any and all liability, including without limitation special, consequential or incidental damages, and (iii) any and all implied warranties, including warranties of fitness for particular purpose, non-infringement and merchantability.

Statements regarding the suitability of products for certain types of applications are based on Vishay's knowledge of typical requirements that are often placed on Vishay products in generic applications. Such statements are not binding statements about the suitability of products for a particular application. It is the customer's responsibility to validate that a particular product with the properties described in the product specification is suitable for use in a particular application. Parameters provided in datasheets and/or specifications may vary in different applications and performance may vary over time. All operating parameters, including typical parameters, must be validated for each customer application by the customer's technical experts. Product specifications do not expand or otherwise modify Vishay's terms and conditions of purchase, including but not limited to the warranty expressed therein.

Except as expressly indicated in writing, Vishay products are not designed for use in medical, life-saving, or life-sustaining applications or for any other application in which the failure of the Vishay product could result in personal injury or death. Customers using or selling Vishay products not expressly indicated for use in such applications do so at their own risk and agree to fully indemnify and hold Vishay and its distributors harmless from and against any and all claims, liabilities, expenses and damages arising or resulting in connection with such use or sale, including attorneys fees, even if such claim alleges that Vishay or its distributor was negligent regarding the design or manufacture of the part. Please contact authorized Vishay personnel to obtain written terms and conditions regarding products designed for such applications.

No license, express or implied, by estoppel or otherwise, to any intellectual property rights is granted by this document or by any conduct of Vishay. Product names and markings noted herein may be trademarks of their respective owners.

Material Category Policy

Vishay Intertechnology, Inc. hereby certifies that all its products that are identified as RoHS-Compliant fulfill the definitions and restrictions defined under Directive 2011/65/EU of The European Parliament and of the Council of June 8, 2011 on the restriction of the use of certain hazardous substances in electrical and electronic equipment (EEE) - recast, unless otherwise specified as non-compliant.

Please note that some Vishay documentation may still make reference to RoHS Directive 2002/95/EC. We confirm that all the products identified as being compliant to Directive 2002/95/EC conform to Directive 2011/65/EU.