

Standard Rectifier

$$V_{RRM} = 2 \times 1600V$$

$$I_{FAV} = 45A$$

$$V_F = 1.23V$$

Phase leg

Part number

DSP45-16AZ

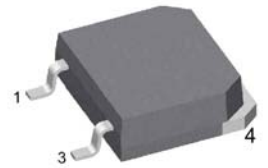

Backside: anode/cathode

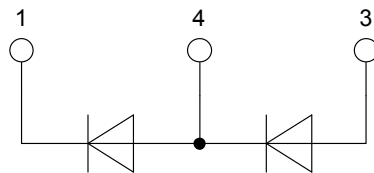

Features / Advantages:

- Planar passivated chips
- Very low leakage current
- Very low forward voltage drop
- Improved thermal behaviour

Applications:

- Diode for main rectification
- For single and three phase bridge configurations

Package: TO-268AA (D3Pak-HV)

- Industry standard outline
- RoHS compliant
- Epoxy meets UL 94V-0

Rectifier				Ratings		
Symbol	Definition	Conditions	min.	typ.	max.	Unit
V_{RSM}	max. non-repetitive reverse blocking voltage				1700	V
V_{RRM}	max. repetitive reverse blocking voltage				1600	V
I_R	reverse current	$V_R = 1600$ V			40	μ A
		$V_R = 1600$ V			1.5	mA
V_F	forward voltage drop	$I_F = 45$ A			1.26	V
		$I_F = 90$ A			1.57	V
		$I_F = 45$ A			1.23	V
		$I_F = 90$ A			1.66	V
I_{FAV}	average forward current	$T_C = 130^\circ$ C			45	A
		180° sine				
V_{FO}	threshold voltage	} for power loss calculation only			0.81	V
r_F	slope resistance				9.1	m Ω
R_{thJC}	thermal resistance junction to case				0.55	K/W
R_{thCH}	thermal resistance case to heatsink			0.15		K/W
P_{tot}	total power dissipation				270	W
I_{FSM}	max. forward surge current	t = 10 ms; (50 Hz), sine			480	A
		t = 8,3 ms; (60 Hz), sine			520	A
		t = 10 ms; (50 Hz), sine			410	A
		t = 8,3 ms; (60 Hz), sine			440	A
I^2t	value for fusing	t = 10 ms; (50 Hz), sine			1.15	kA ² s
		t = 8,3 ms; (60 Hz), sine			1.13	kA ² s
		t = 10 ms; (50 Hz), sine			840	A ² s
		t = 8,3 ms; (60 Hz), sine			805	A ² s
C_J	junction capacitance	$V_R = 400$ V; f = 1 MHz			18	pF

Package TO-268AA (D3Pak-HV)			Ratings			
Symbol	Definition	Conditions	min.	typ.	max.	Unit
I_{RMS}	RMS current	per terminal			70	A
T_{VJ}	virtual junction temperature		-40		175	°C
T_{op}	operation temperature		-40		150	°C
T_{stg}	storage temperature		-40		150	°C
Weight				4		g
F_C	mounting force with clip		20		120	N
$d_{Spp/App}$	creepage distance on surface striking distance through air	terminal to terminal	9.4			mm
$d_{Spbl/Apb}$		terminal to backside	5.6			mm

Product Marking

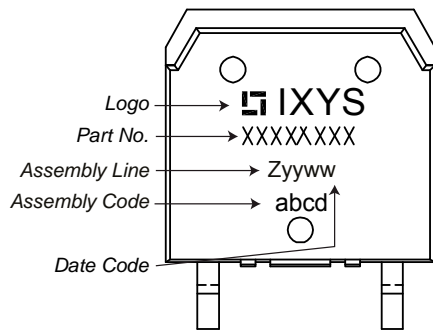

Ordering	Part Number	Marking on Product	Delivery Mode	Quantity	Code No.
Standard	DSP45-16AZ	DSP45-16AZ	Tube	30	514141

Similar Part	Package	Voltage class
DSP45-12AZ	TO-268AA (D3Pak) (2HV)	1200
DSP45-12A	TO-247AD (3)	1200
DSP45-16A	TO-247AD (3)	1600
DSP45-16AR	ISOPLUS247 (3)	1600
DSP45-18A	TO-247AD (3)	1800

Equivalent Circuits for Simulation

* on die level

$T_{VJ} = 175\text{ °C}$

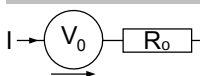

Rectifier

$V_{0\ max}$	threshold voltage	0.81	V
$R_{0\ max}$	slope resistance *	6.5	mΩ

Outlines TO-268AA (D3Pak-HV)

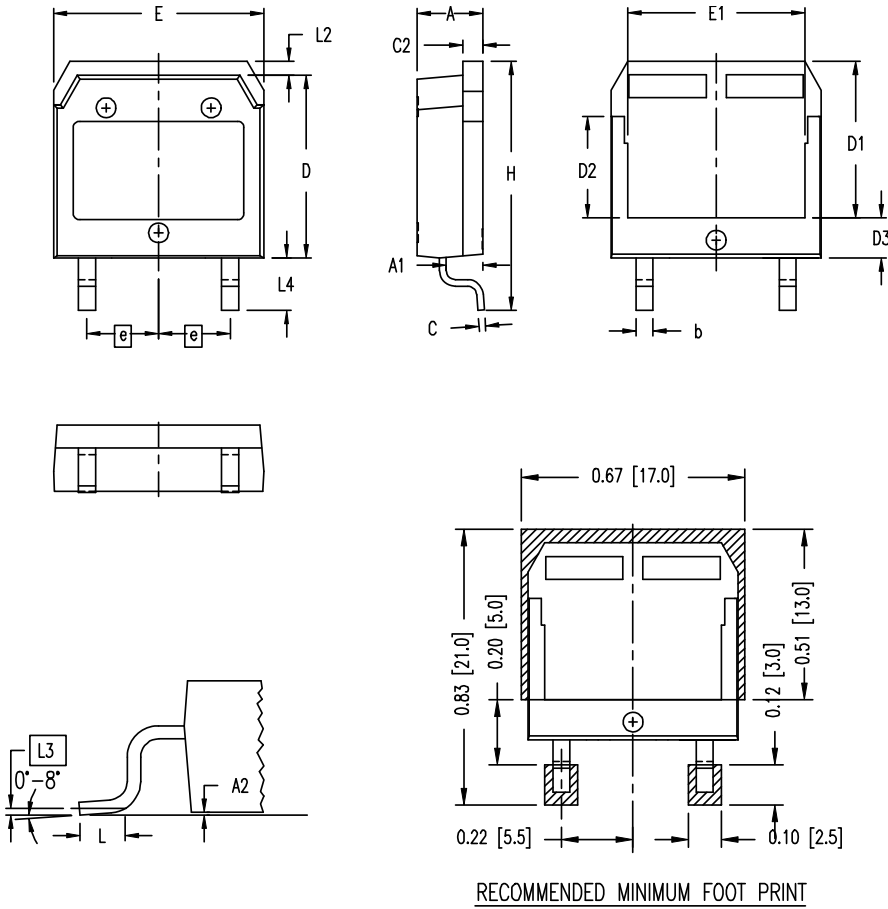

Dim.	Millimeter		Inches	
	min	max	min	max
A	4.90	5.10	0.193	0.201
A1	2.70	2.90	0.106	0.114
A2	0.02	0.25	0.001	0.010
b	1.15	1.45	0.045	0.057
C	0.40	0.65	0.016	0.026
C2	1.45	1.60	0.057	0.063
D	13.80	14.00	0.543	0.551
D1	11.80	12.10	0.465	0.476
D2	7.50	7.80	0.295	0.307
D3	2.90	3.20	0.114	0.126
E	15.85	16.05	0.624	0.632
E1	13.30	13.60	0.524	0.535
e	5.450 BSC		0.215 BSC	
H	18.70	19.10	0.736	0.752
L	1.70	2.00	0.067	0.079
L2	1.00	1.15	0.039	0.045
L3	0.250 BSC		0.010 BSC	
L4	3.80	4.10	0.150	0.161

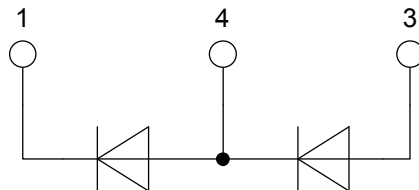

Rectifier

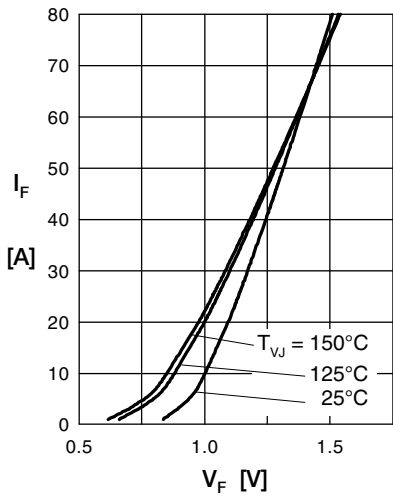

Fig. 1 Forward current versus voltage drop per diode

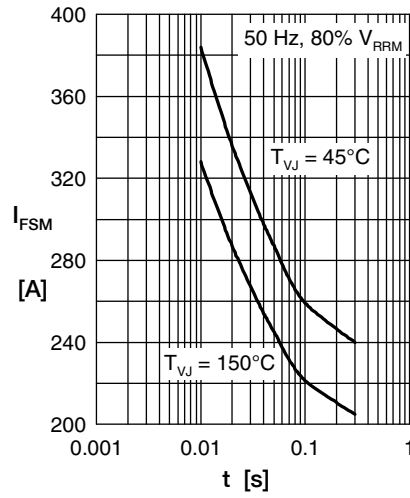

Fig. 2 Surge overload current

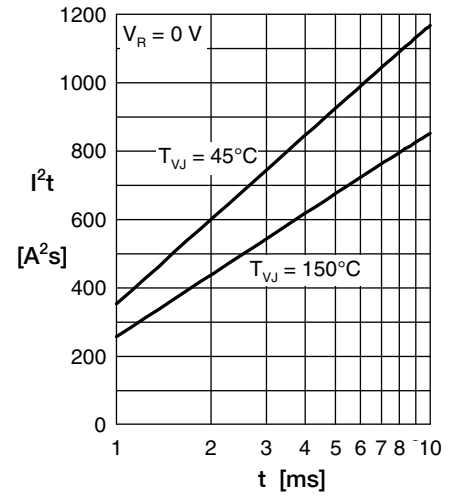

Fig. 3 I^2t versus time per diode

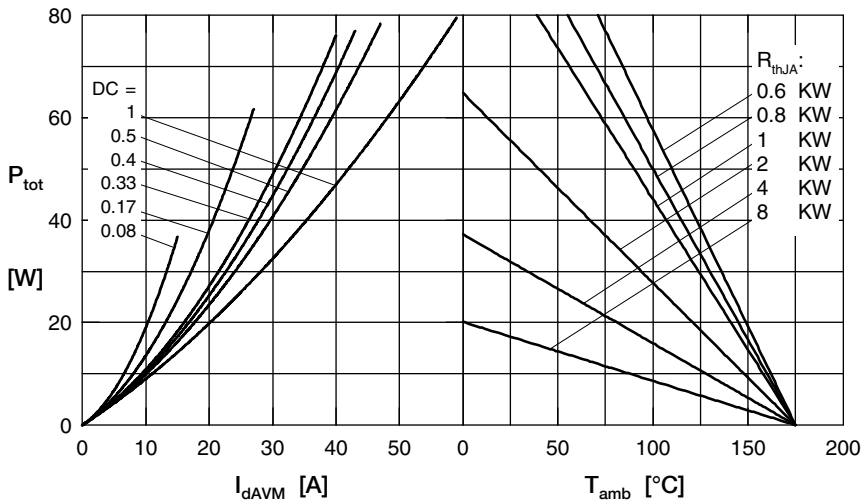

Fig. 4 Power dissipation vs. direct output current & ambient temperature

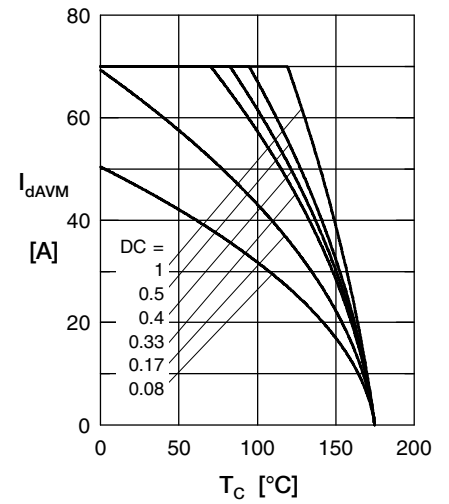

Fig. 5 Max. forward current vs. case temperature

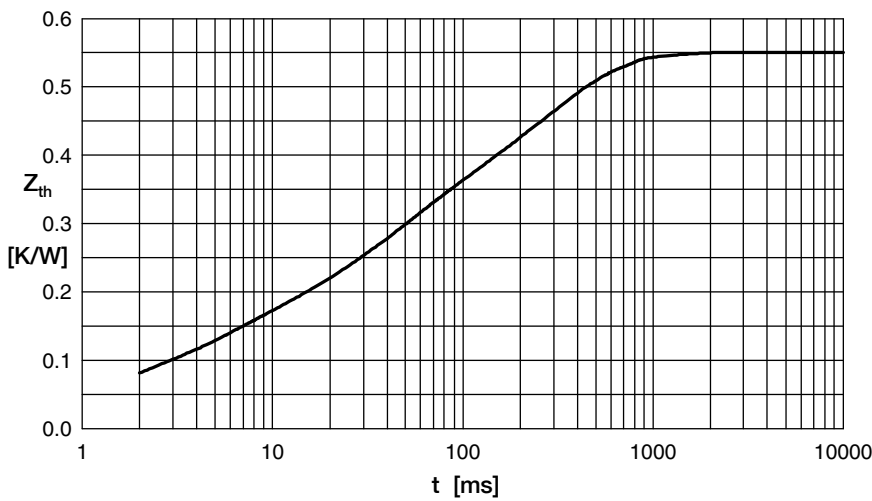

Fig. 6 Transient thermal impedance junction to case

i	R_i	t_i
1	0.033	0.0006
2	0.095	0.0039
3	0.164	0.033
4	0.258	0.272