

INTRODUCTION

The S1A2224A01 is a monolithic integrated circuit consisting of a dual equalizer amplifier with ALC, and it is suitable for stereo radio cassette-tape players.

FEATURES

- Dual equalizer amplifier with a built-in ALC circuit
- Recording amp available because of high gain characteristics (Variable monitor possible)
- Good channel separation (sep = 50dB Typ)
- Quick stabilization after power on
- Capable of direct meter driving and ALC transistor
- Good ALC response balance between channels
- Wide operating supply voltage range: $V_{CC} = 4V - 13V$

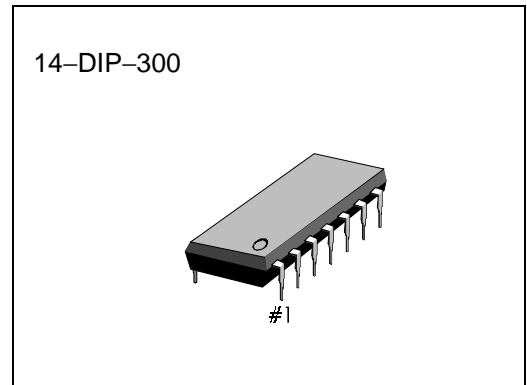

ORDERING INFORMATION

Device	Package	Operating Temperature
S1A2224A01-D0B0	14-DIP-300	-20°C — +70°C

BLOCK DIAGRAM

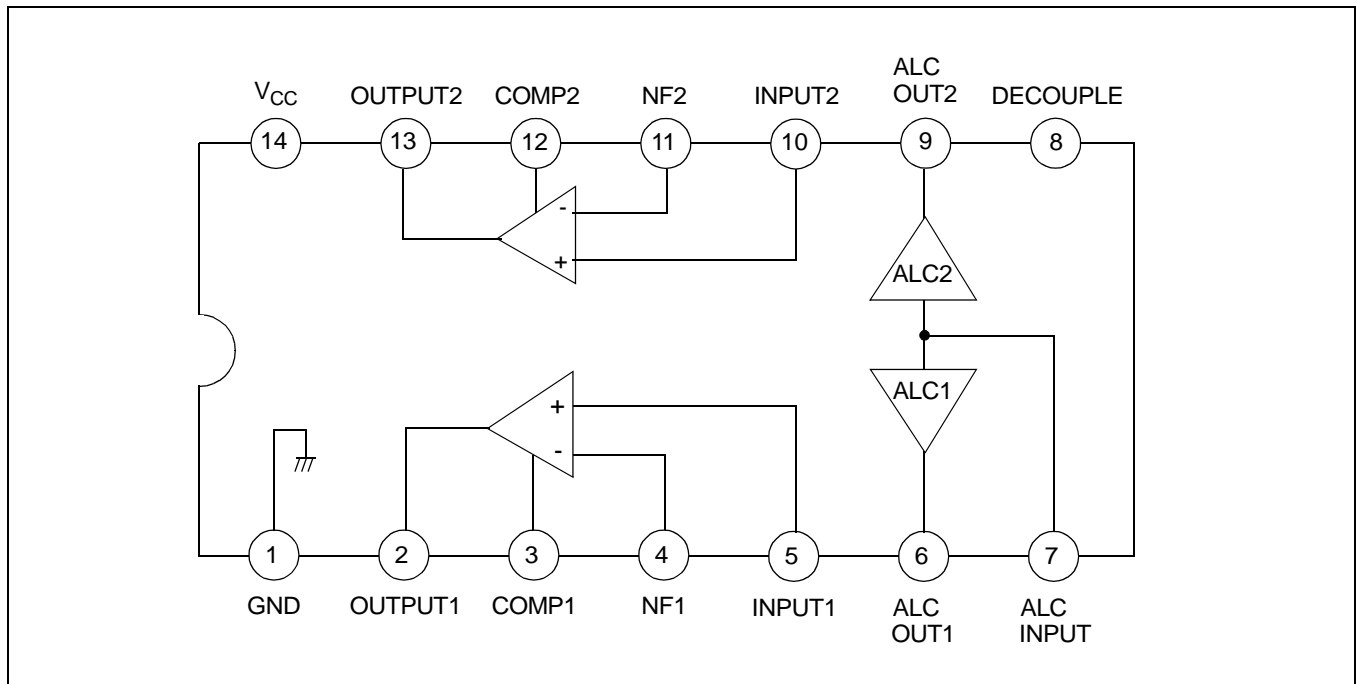

ABSOLUTE MAXIMUM RATINGS (Ta =25°C)

Characteristic	Symbol	Value	Unit
Supply Voltage	V_{CC}	14	V
Power Dissipation	P_D	600	mW
Operating Temperature	T_{OPR}	-20 — +70	°C
Storage Temperature	T_{STG}	-40 — +125	°C
ALC TR Maximum Current	—	3.5	mA

ELECTRICAL CHARACTERISTICS

(Ta = 25°C, Vcc = 5V, RL = 10kΩ, f = 1kHz: play, RL = 680Ω: Recording)

Characteristic	Symbol	Test Conditions	Min.	Typ.	Max.	Unit
Quiescent Circuit Current	I _{CCQ}	V _I = 0	–	4.5	10	mA
Open Loop Voltage Gain	G _{VO}	–	–	85	–	dB
Closed Loop Voltage Gain	G _{VC1}	Play	–	40	–	dB
	G _{VC2}	Record	–	58	–	dB
Output Voltage	V _O	THD = 1%, Play	0.9	1.2	–	V
Total Harmonic Distortion	THD	V _O = 0.5V, Play	–	0.1	1.0	%
Input Resistance	R _I	–	21	30	–	kΩ
Equivalent Input Noise Voltage	V _{NI}	BW (–3dB) = 20Hz – 20kHz	–	1.0	2.0	μV
Cross Talk	CT	R _G = 2.2kΩ	40	50	–	dB
ALC Range	V _{ALC}	V _I = –60dBm, Record	35	45	–	dB
ALC Balance	CB _{ALC}	V _I = –20dBm, Record	–	0	2.0	dB
ALC Distortion	THD _{ALC}	V _I = –20dBm, Record	–	0.5	2.0	%

OUTPUT VOLTAGE-INPUT VOLTAGE

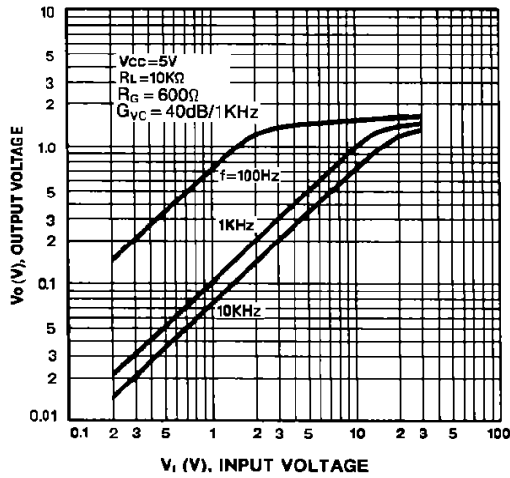

TOTAL HARMONIC DISTORTION-OUTPUT VOLTAGE

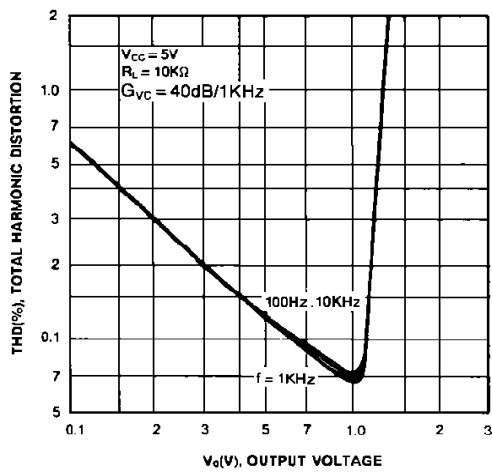

TOTAL HARMONIC DISTORTION-SUPPLY VOLTAGE

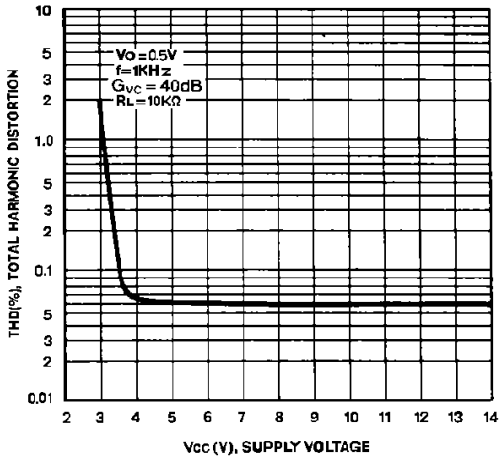

ALC OUTPUT VOLTAGE — INPUT VOLTAGE
ALC TOTAL HARMONIC DISTORTION

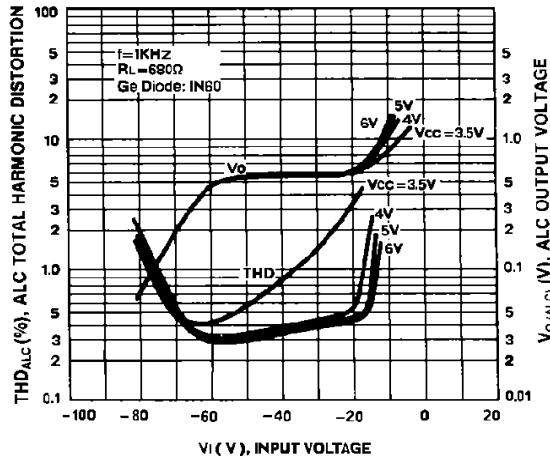

VOLTAGE GAIN-FREQUENCY

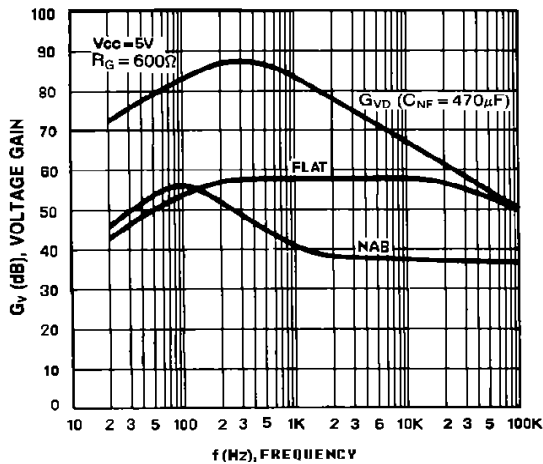

EQUIVALENT INPUT NOISE VOLTAGE -GENERATOR RESISTANCE

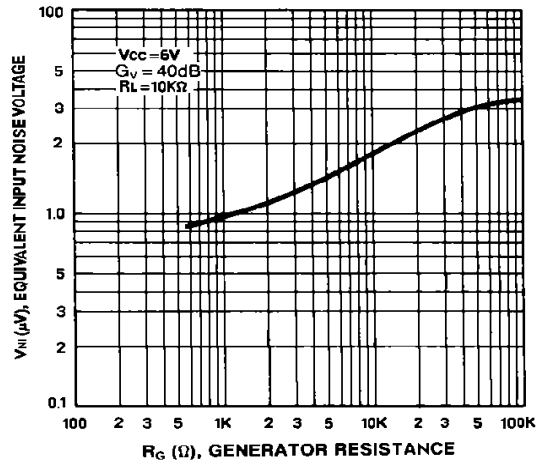

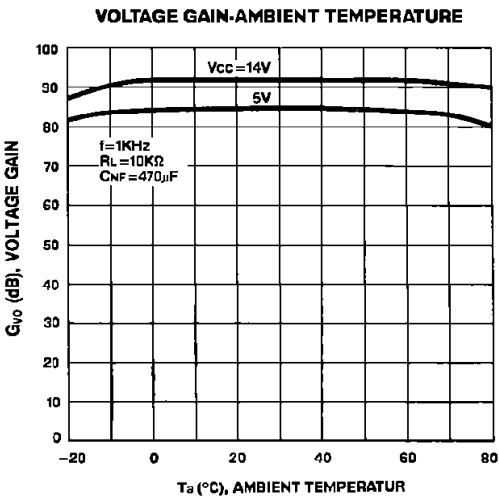
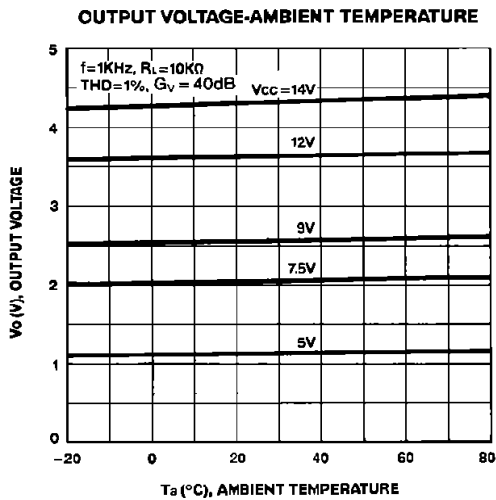
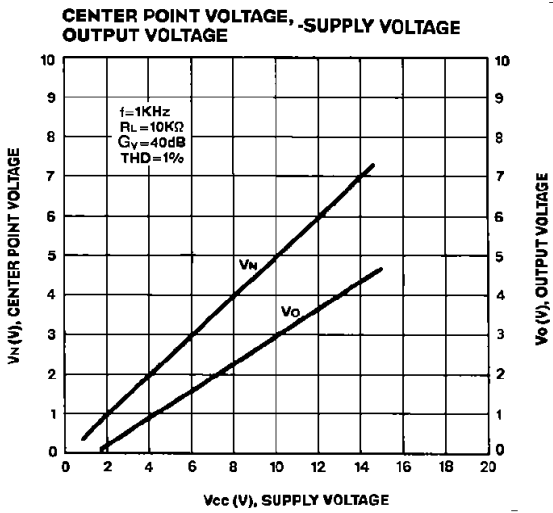
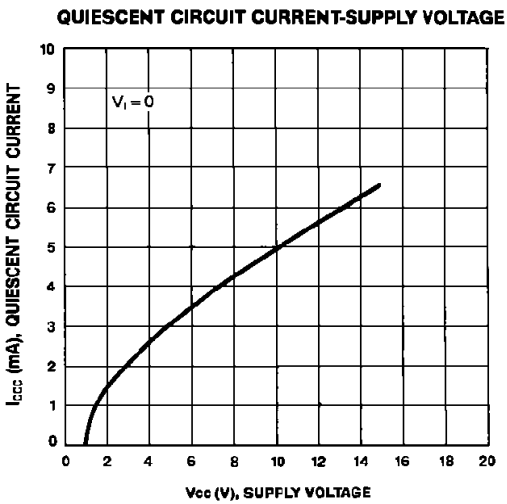
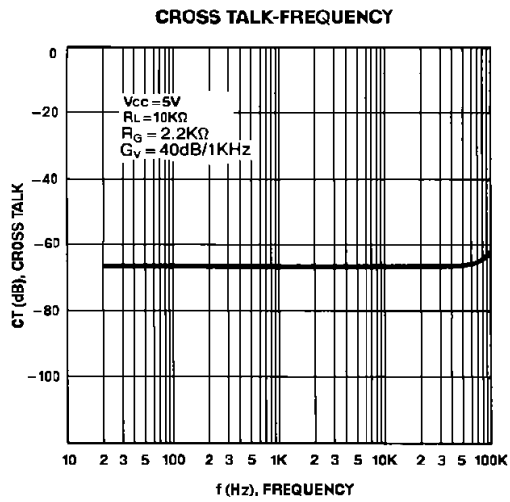
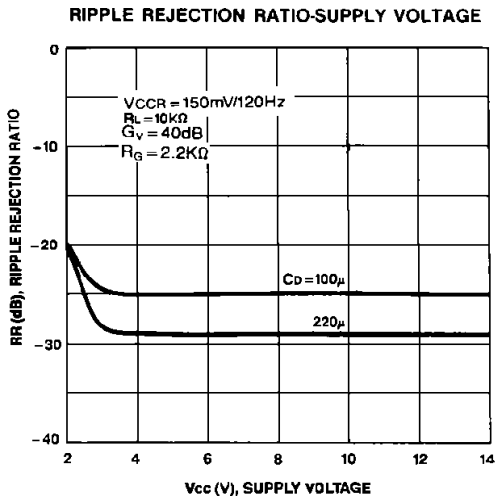

APPLICATION INFORMATION

Closed Loop Voltage Gain

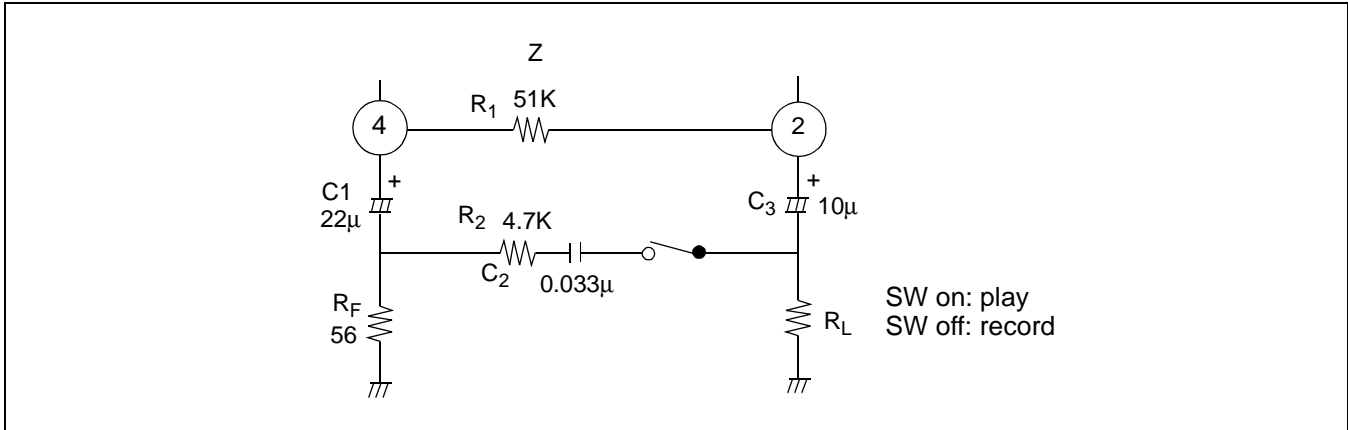

A. Playback amplifier

$$G_v = 20 \log \frac{Z}{R_F} \text{ (dB) at } f = 1 \text{ kHz, } G_v = 42 \text{ dB (Typ) } Z = R_1 // \left(R_2 + \frac{1}{2\pi f \cdot C_2} \right)$$

B. Recording amplifier

$$G_v = 20 \log \frac{R_1}{R_F} \text{ (dB) at } f = 1 \text{ kHz, } G_v = 58 \text{ dB (Typ)}$$

