

## SOD123FL Plastic-Encapsulate Diodes

### Schottky Rectifier

#### Features

- $I_o$  1A
- $V_{RRM}$  20V-100V
- High surge current capability
- Polarity: Color band denotes cathode

#### Applications

- Rectifier

#### Marking

- DSS12-DSS110 : S12-S110

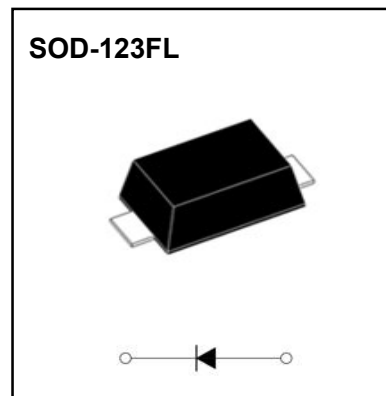

#### Limiting Values (Absolute Maximum Rating)

Item	Symbol	Unit	Test Conditions	DSS	DSS	DSS	DSS	DSS	DSS	DSS	DSS
				12	13	14	15	16	18	19	110
Repetitive Peak Reverse Voltage	$V_{RRM}$	V		20	30	40	50	60	80	90	100
Maximum RMS Voltage	$V_{RMS}$	V		14	21	28	35	42	56	63	70
Average Forward Current	$I_{F(AV)}$	A	60HZ Half-sine wave, Resistance load, TL(Fig.1)	1.0							
Surge(Non-repetitive)Forward Current	$I_{FSM}$	A	60Hz Half-sine wave ,1 cycle , $T_a=25^{\circ}C$	25							
Junction Temperature	$T_J$	$^{\circ}C$		-55~+125				-55~+150			
Storage Temperature	$T_{STG}$	$^{\circ}C$		-55 ~ +150							

#### Electrical Characteristics ( $T_a=25^{\circ}C$ Unless otherwise specified)

Item	Symbol	Unit	Test Condition	DSS	DSS	DSS	DSS	DSS	DSS	DSS		
				12	13	14	15	16	18	19	110	
Peak Forward Voltage	$V_F$	V	$I_F=1.0A$	0.55			0.7		0.85			
Peak Reverse Current	$I_{RRM1}$	mA	$V_{RM}=V_{RRM}$	$T_a=25^{\circ}C$					0.5		0.1	
	$I_{RRM2}$			10			5.0					
Thermal Resistance(Typical)	$R_{\theta J-A}$	$^{\circ}C/W$	Between junction and ambient	88 <sup>1)</sup>								
	$R_{\theta J-L}$		Between junction and terminal	28 <sup>1)</sup>								

#### Notes:

Thermal resistance from junction to ambient and from junction to lead mounted on P.C.B. with 0.2" x 0.2" (5.0 mm x 5.0 mm) copper pad areas

# Typical Characteristics

FIG.1: FORWARD CURRENT DERATING CURVE

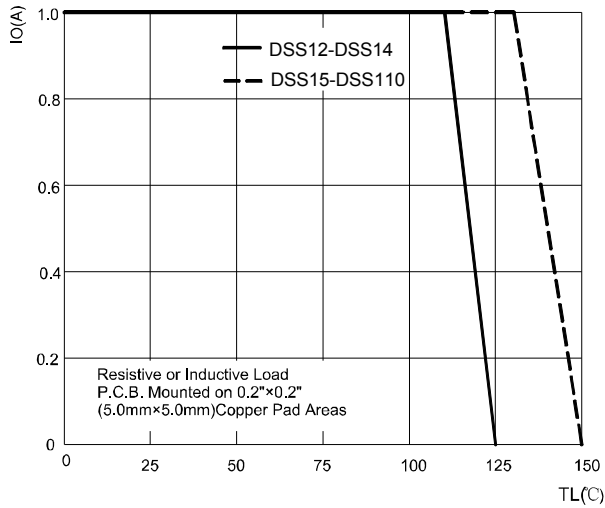

FIG.2: MAXIMUM NON-REPETITIVE FORWARD URGE CURRENT

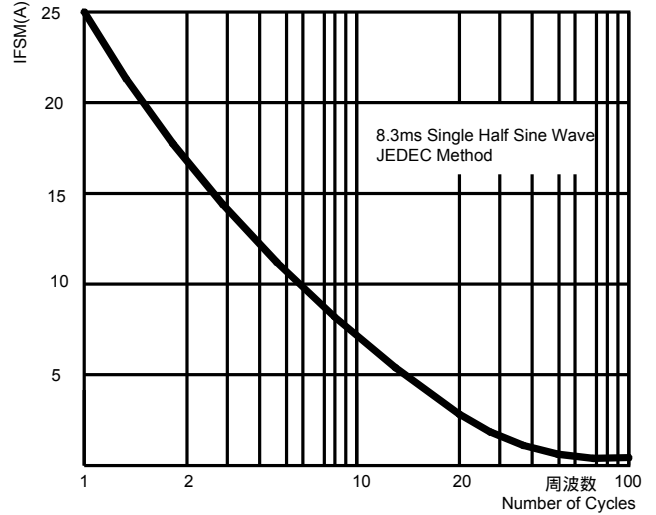

FIG.3: TYPICAL FORWARD CHARACTERISTICS

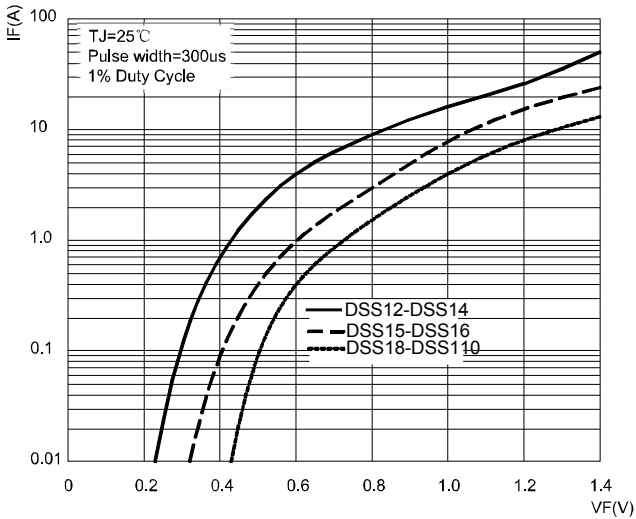
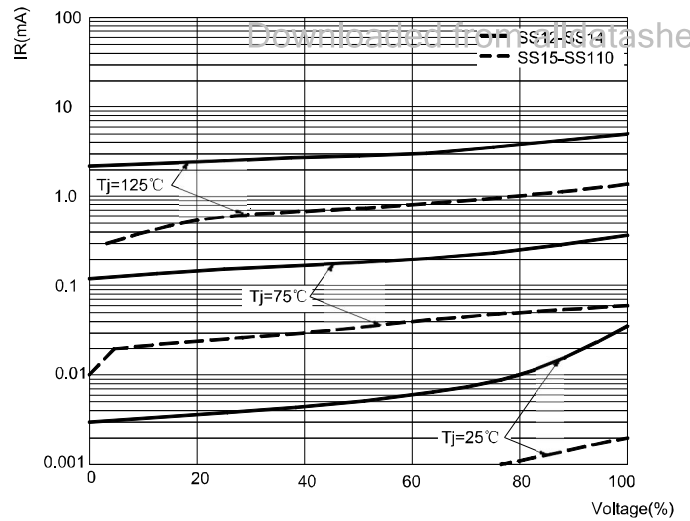
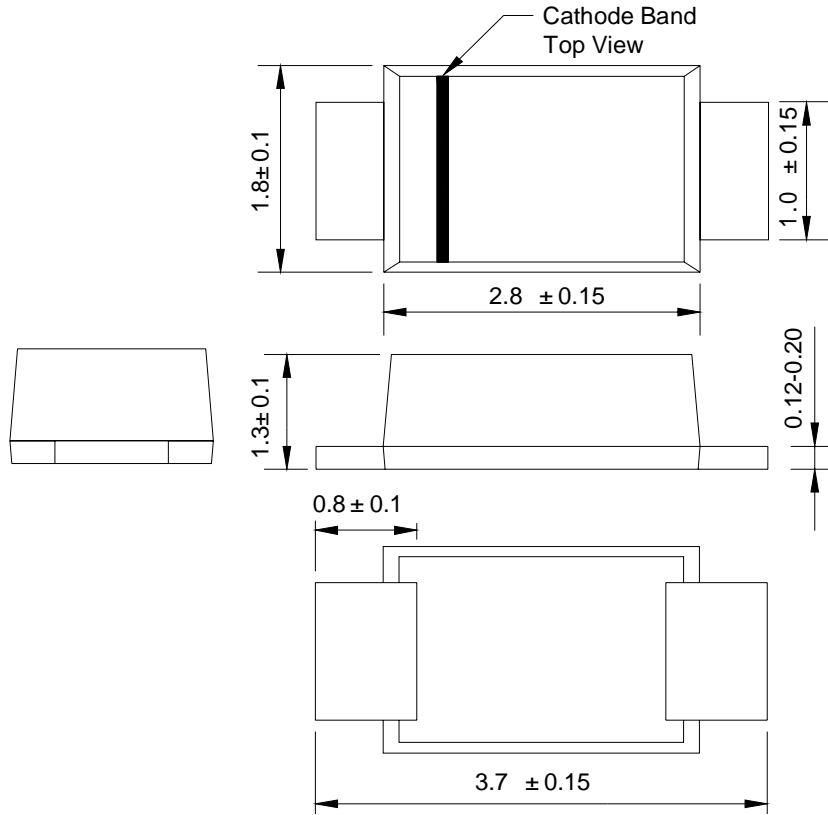

FIG.4 : TYPICAL REVERSE CHARACTERISTICS



## SOD-123FL Package Outline Dimensions



Dimensions in millimeters

Downloaded from alldatasheet.com

## SOD-123FL Suggested Pad Layout

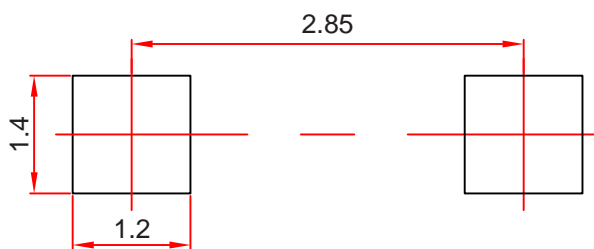

**Note:**

1. Controlling dimension: in millimeters.
2. General tolerance:  $\pm 0.05$  mm.
3. The pad layout is for reference purposes only.

**NOTICE**

JSHD reserve the right to make modifications, enhancements, improvements, corrections or other changes without further notice to any product herein. JSHD does not assume any liability arising out of the application or use of any product described herein.

# Reel Taping Specifications For Surface Mount Devices–SOD123FL

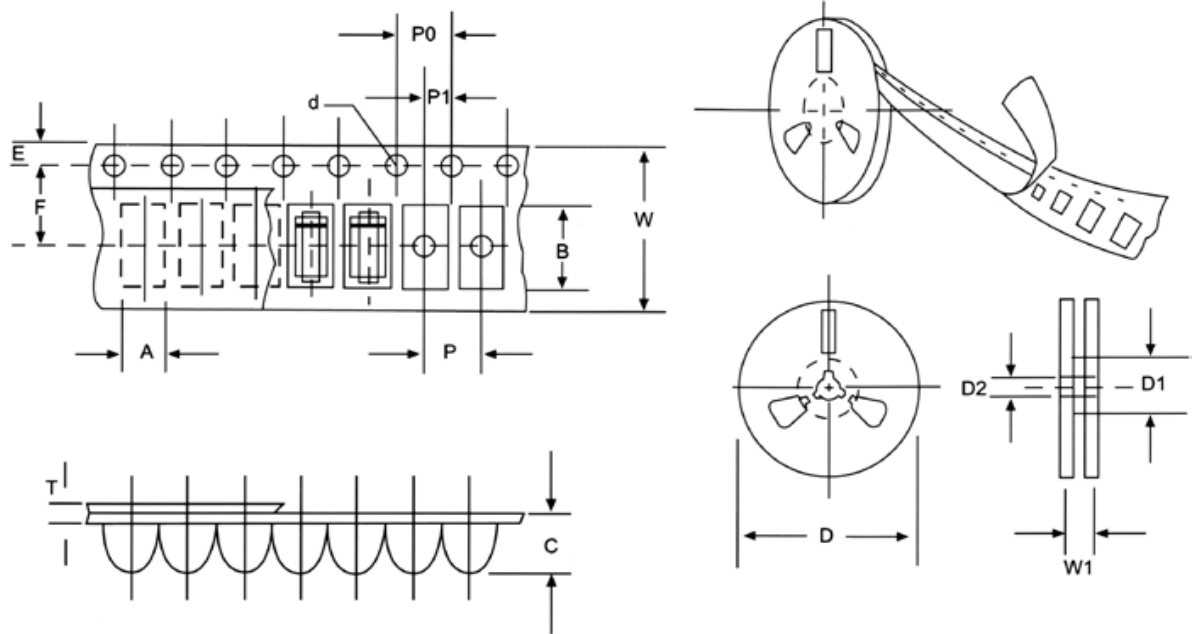

**FIG:CONFIGURATION OF AXIAL TAPING**

ITEM	SYMBOL	SOD123FL mm(inch)
Carrier width	A	2.05+0.1(0.081+0.004)
Carrier length	B	3.95+0.1(0.156+0.004)
Carrier depth	C	1.45+0.1(0.057+0.004)
Sprocket hole	d	1.55+0.05(0.061+0.002)
Reel outside diameter	D	280/178+2.0(11/7.0+0.079)
Reel inner diameter	D1	8.0+0.2(0.315+0.008)
Feed hole diameter	D2	13+0.5(0.512+0.020)
Sprocket hole position	E	1.75+0.1(0.069+0.004)
Punch hole position	F	3.50+0.1(0.138+0.002)
Punch hole pitch	P	4.0+0.1(0.157+0.004)
Sprocket hole pitch	P0	4.0+0.1(0.157+0.004)
Embossment center	P1	0.21-0.25(0.008-0.010)
Totall tape thickness	T	8.0+0.3/-0.1(0.315+0.012/-0.004)
Tape width	W	2.0+0.1(0.079+0.004)
Reel width	W1	10.0+2.0(0.394+0.079)

NOTE:Devices are packde in accordance with EIA standard RS-481-A and specification given above.