

Features

- Heatsink design
- Schottky barrier diodes
- Low forward voltage drop
- Moisture sensitivity: level 1, per J-STD-020
- Solder dip 260 °C, 10 s
- Low profile - typical height of 1.1 mm
- High temperature soldering guaranteed: 260°C/10 seconds
- Halogen-free according to IEC 61249-2-21 definition

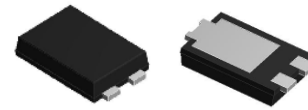

eSGC (TO-277)

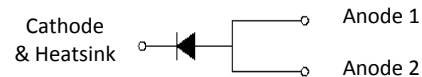

Typical Applications

For low voltage high frequency inverters, DC/DC converters and polarity protection application.

Maximum Ratings (TA = 25 °C unless otherwise noted)			
Parameter	Symbol	SGC201BS	Unit
Maximum repetitive peak reverse voltage	VRRM	100	V
Maximum RMS voltage	VRMS	70	V
Maximum DC blocking voltage	VDC	100	V
Maximum average forward rectified current	IF(AV) ¹	10.0	A
	IF(AV) ²	20.0	
Peak forward surge current 8.3 ms single half sine-wave superimposed on rated load	IFSM	250	A
Operating junction and storage temperature range	TJ, TSTG	-55 to +150	°C

Electrical Characteristics (TA = 25 °C unless otherwise noted)						
Parameter	Test Conditions		Symbol	TYP.	MAX.	Unit
Instantaneous forward voltage	IF=2A	TA=25°C	VF	0.42	-	Volts
	IF=20A			0.62	0.75	
Instantaneous reverse current at rated DC blocking voltage	VR=100V	TA=25°C	IR	-	250	uA
		TA=100°C		-	30	mA
Typical junction capacitance	4.0 V, 1 MHz		CJ	1.8		nF
Typical thermal resistance	junction to ambient		RθJA ¹	75		°C/W
	junction to mount		RθJM ²	1		°C/W

Notes,1)Thermal resistance RθJA is junction to ambient. Free air,mounted on P.C.B with recommended copper pad area,2 OZ,FR4

2)Thermal resistance RθJM is junction to mount.Mounted on P.C.B with 30*30mm copper pad area

Ratings and Characteristics Curves

(TA = 25°C unless otherwise noted)

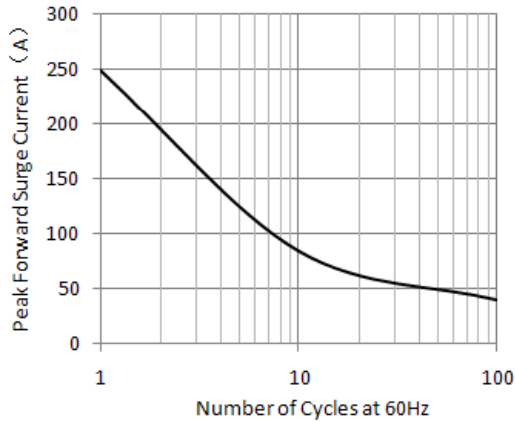

Figure 1. Maximum Non-Repetitive Peak Forward Surge Current

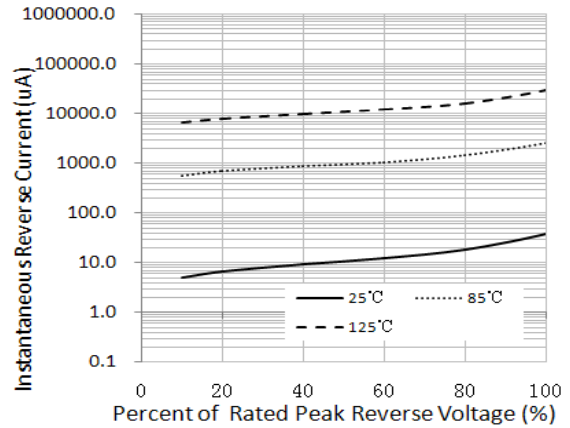

Figure 2. Typical Reverse Characteristics

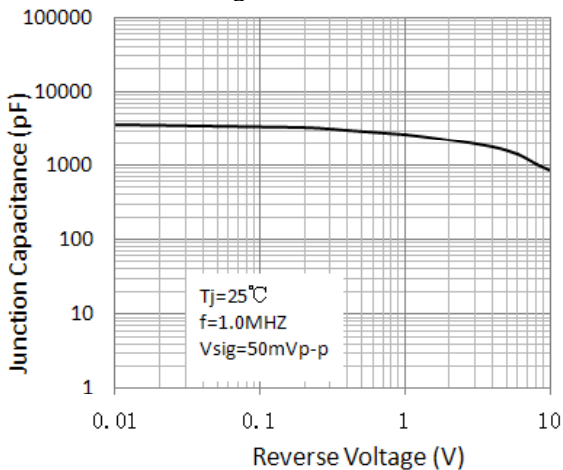

Figure 3. Typical Junction Capacitance

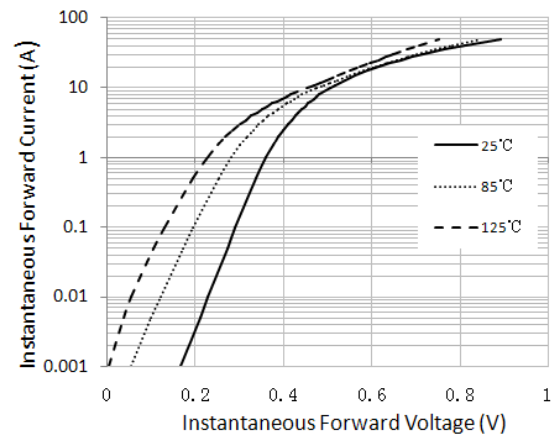

Figure 4. Typical Instantaneous Forward Characteristics

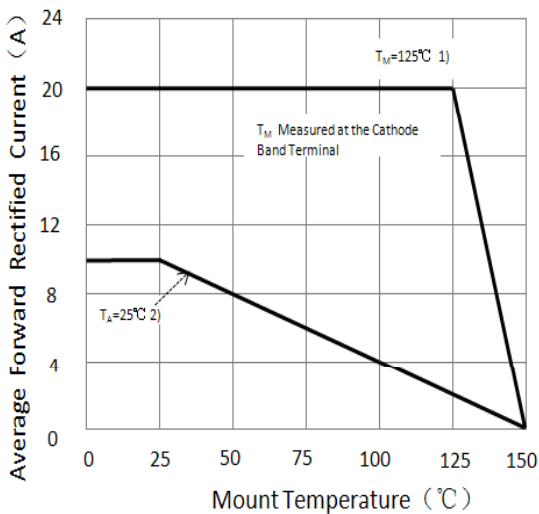
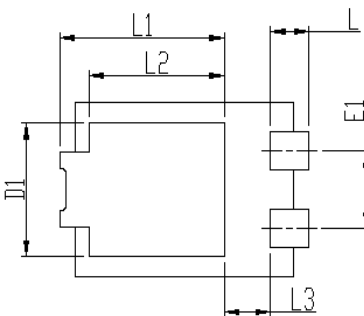
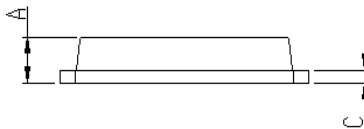
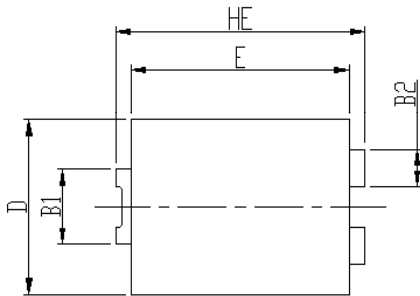

Figure 5. Forward Current Derating Curve

- 1), Mounted on P.C.B with 30*30mm copper pad area
- 2), Mounted on P.C.B with recommended copper pad area

Package Outline Dimensions



DIM	Unit: mm		Unit: inch	
	MIN	MAX	MIN	MAX
HE	6.4	6.6	0.252	0.260
E	5.6	5.8	0.220	0.228
D	4.1	4.3	0.161	0.169
B1	1.7	1.9	0.067	0.075
B2	0.8	1	0.031	0.039
A	1.05	1.2	0.041	0.047
C	0.3	0.4	0.012	0.016
L	0.85	1.1	0.033	0.043
L1	4.2	4.4	0.165	0.173
L2	3.52 Typ.		0.139 Typ.	
L3	1.1	1.4	0.043	0.055
D1	3	3.3	0.118	0.130
E1	1.86 Typ.		0.073 Typ.	

Soldering footprint

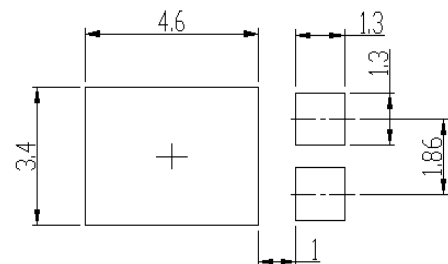

Packing Information

Packing quantities:

5000 pcs/Reel, 12mm Tape, 13" Reel

Tape & Reel Specification

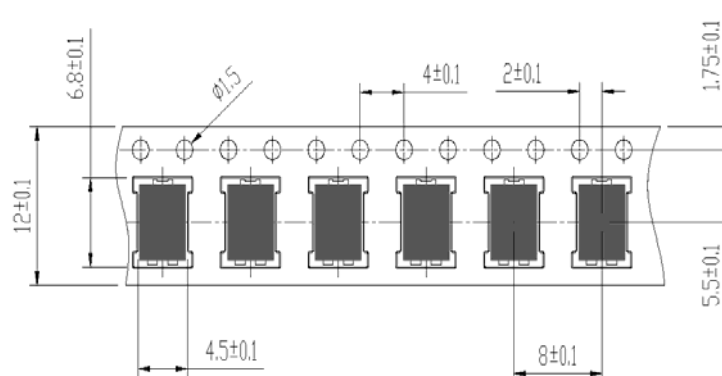



Disclaimers

These materials are intended as a reference to assist our customers in the selection of the Suzhou Good-Ark product best suited to the customer's application; they do not convey any license under any intellectual property rights, or any other rights, belonging to Suzhou Good-Ark Electronics Co., Ltd. or a third party.

Suzhou Good-Ark Electronics Co., Ltd. assumes no responsibility for any damage, or infringement of any third-party's rights, originating in the use of any product data, diagrams, charts, programs, algorithms, or circuit application examples contained in these materials.

All information contained in these materials, including product data, diagrams, charts, programs and algorithms represents information on products at the time of publication of these materials, and are subject to change by Suzhou Good-Ark Electronics Co., Ltd. without notice due to product improvements or other reasons. It is therefore recommended that customers contact Suzhou Good-Ark Electronics Co., Ltd. or an authorized Suzhou Good-Ark Electronics Co., Ltd. for the latest product information before purchasing a product listed herein. The information described here may contain technical inaccuracies or typographical errors. Suzhou Good-Ark Electronics Co., Ltd. assumes no responsibility for any damage, liability, or other loss rising from these inaccuracies or errors. Please also pay attention to information published by Suzhou Good-Ark Electronics Co., Ltd. by various means, including our website home page.
(<http://www.goodark.com>)

When using any or all of the information contained in these materials, including product data, diagrams, charts, programs, and algorithms, Please be sure to evaluate all information as a total system before making a final decision on the applicability of the information and products. Suzhou Good-Ark Electronics Co., Ltd. assumes no responsibility for any damage, liability or other loss resulting from the information contained herein.

The prior written approval of Suzhou Good-Ark Electronics Co., Ltd. is necessary to reprint or reproduce in whole or in part these materials.

Please contact Suzhou Good-Ark Electronics Co., Ltd. or an authorized distributor for further details on these materials or the products contained herein.