

Features

- $S_{21} = 18.4 \text{ dB @ } 890 \text{ MHz}$
= $17.6 \text{ dB @ } 960 \text{ MHz}$
- NF of 0.8 dB over Frequency
- Unconditionally Stable
- Single 5V Supply
- High OIP3 @ Low Current

Description

The plerow™ ALN-series is the compactly designed surface-mount module for the use of the LNA with or without the following gain blocks in the infrastructure equipment of the mobile wireless (CDMA, GSM, PCS, PHS, WCDMA, DMB, WLAN, WiBro, WiMAX), GPS, satellite communication terminals, CATV and so on. It has an exceptional performance of low noise figure, high gain, high OIP3, and low bias current. The stability factor is always kept more than unity over the application band in order to ensure its unconditionally stable implementation to the application system environment. The surface-mount module package including the completed matching circuit and other components necessary just in case allows very simple and convenient implementation onto the system board in mass production level.

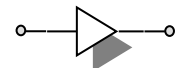

1-stage Single Type

Specifications (in Production)

Typ. @ T = 25°C, $V_s = 5 \text{ V}$, Freq. = 925 MHz, $Z_{o,sys} = 50 \text{ ohm}$

Parameter	Unit	Specifications		
		Min	Typ	Max
Frequency Range	MHz	890		960
Gain	dB	17	18	
Gain Flatness	dB		± 0.4	± 0.5
Noise Figure	dB		0.8	0.85
Output IP3 ⁽¹⁾	dBm	28	30.5	
S11 / S22 ⁽²⁾	dB			-14 / -14
Output P1dB	dBm	15	16.5	
Switching Time ⁽³⁾	μsec		-	
Supply Current	mA		60	70
Supply Voltage	V		5	
Impedance	Ω		50	
Max. RF Input Power	dBm	C.W 23 ~ 25 (before fail)		
Package Type & Size	mm	Surface Mount Type, 10Wx10Lx3.8H		

Operating temperature is -40°C to +85°C.

1) OIP3 is measured with two tones at an output power of 0 dBm / tone separated by 1 MHz.

2) S11/S22 (max) is the worst value within the frequency band.

3) Switching time means the time that takes for output power to get stabilized to its final level after switching DC voltage from 0 V to V_s .

More Information

Website: www.asb.co.kr
E-mail: sales@asb.co.kr

Tel: (82) 42-528-7223
Fax: (82) 42-528-7222

Outline Drawing (Unit: mm)

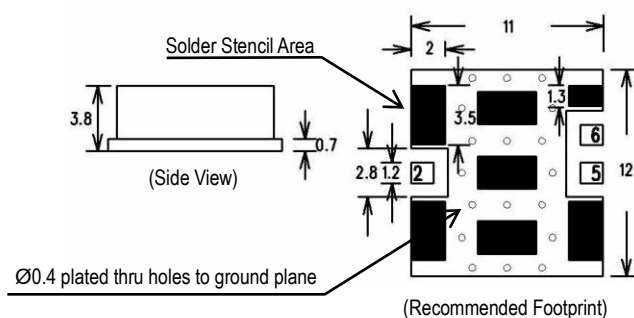
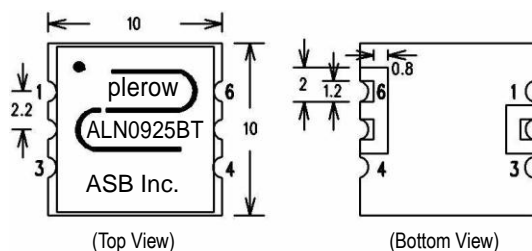

Pin Number	Function
2	RF In
5	RF Out
6	+Vcc
Others	Ground

Note: 1. The number and size of ground via holes in a circuit board is critical for thermal RF grounding considerations.

2. We recommend that the ground via holes be placed on the bottom of all ground pins for better RF and thermal performance, as shown in the drawing at the left side.

**Typical Performance
(Measured)**

890~960 MHz

+5 V

S-parameters

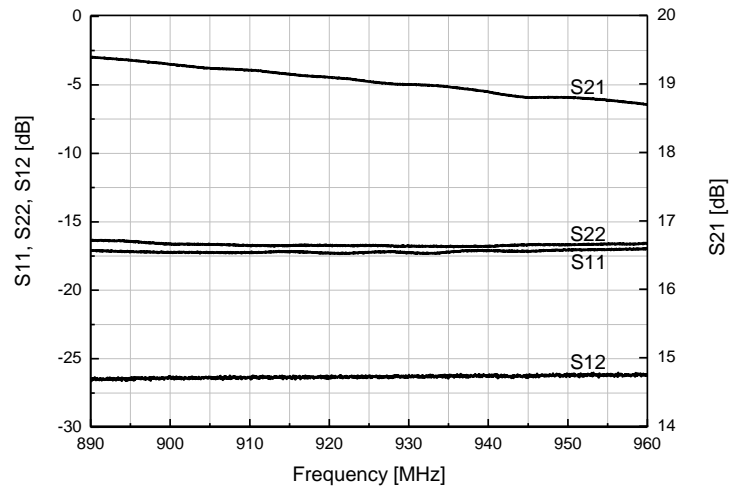

S-parameters & K Factor

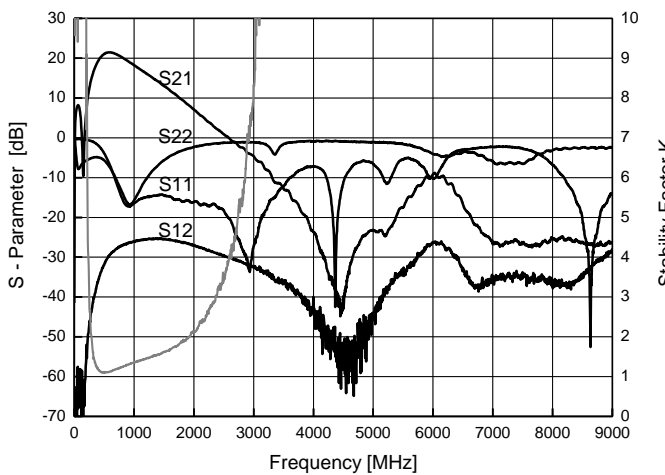

Noise Figure

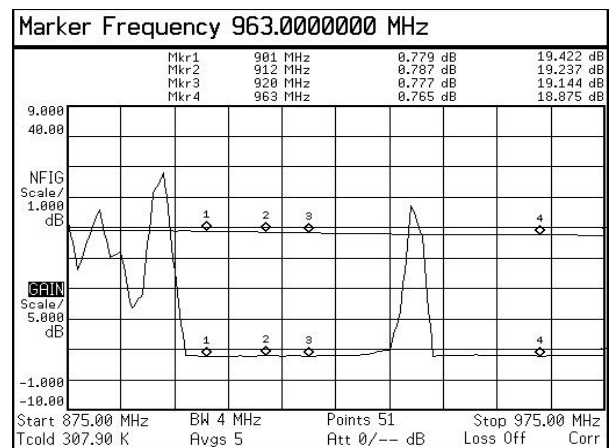

OIP3

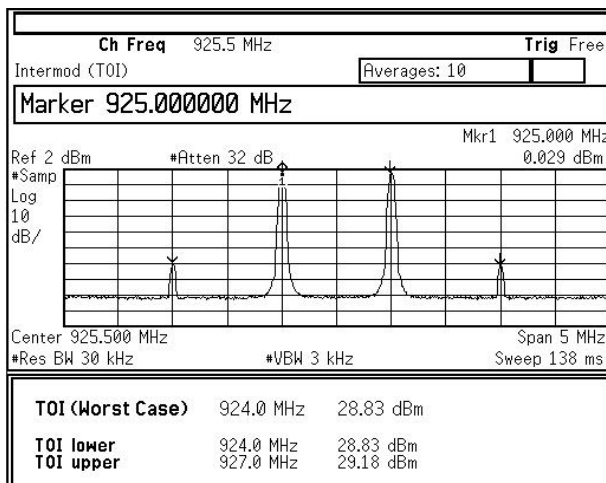

P1dB

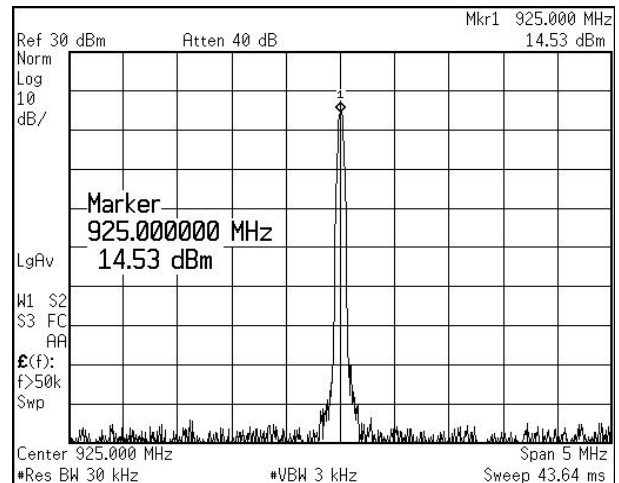

RF Performance with Voltage Change

1. S-parameter

	890 MHz			925 MHz				960 MHz		
	S21 (dB)	S11 (dB)	S22 (dB)	S21 (dB)	G/F (dB)	S11 (dB)	S22 (dB)	S21 (dB)	S11 (dB)	S22 (dB)
4.50 V	18.58	-20.17	-15.51	18.27	0.52	-20.73	-17.02	18.06	-21.02	-18.58
4.75 V	18.60	-20.55	-15.43	18.30	0.52	-21.13	-16.92	18.08	-21.48	-18.40
5.00 V	18.61	-20.88	-15.29	18.31	0.52	-21.49	-16.77	18.09	-21.85	-18.26
5.25 V	18.61	-21.13	-15.17	18.31	0.52	-21.78	-16.63	18.09	-22.18	-18.09
5.50 V	18.61	-21.33	-15.04	18.31	0.51	-22.10	-16.45	18.10	-22.47	-17.90

2. OIP3, P1dB & NF

	890 MHz			925 MHz			960 MHz		
	OIP3 (dBm)	P1dB (dBm)	NF (dB)	OIP3 (dBm)	P1dB (dBm)	NF (dB)	OIP3 (dBm)	P1dB (dBm)	NF (dB)
4.50 V	29.32	16.44	0.703	29.78	16.07	0.692	28.93	16.05	0.671
4.75 V	29.08	16.84	0.684	29.58	16.59	0.665	28.65	16.51	0.684
5.00 V	28.84	17.25	0.697	29.32	17.00	0.685	28.41	16.97	0.730
5.25 V	28.73	17.64	0.729	29.27	17.44	0.715	28.31	17.45	0.814
5.50 V	28.79	18.06	0.765	29.30	17.83	0.743	28.32	17.85	0.832

Note: tested at room temperature.

RF Performance with Operating Temperature

1. S-parameter

	890 MHz			925 MHz				960 MHz		
	S21 (dB)	S11 (dB)	S22 (dB)	S21 (dB)	G/F (dB)	S11 (dB)	S22 (dB)	S21 (dB)	S11 (dB)	S22 (dB)
-45 °C	19.39	-20.77	-15.26	19.09	0.65	-24.38	-16.18	18.74	-23.25	-17.17
-10 °C	19.18	-21.12	-15.15	18.88	0.64	-23.65	-16.11	18.54	-21.87	-17.14
25 °C	18.97	-20.17	-15.10	18.65	0.64	-22.53	-16.19	18.33	-20.54	-17.24
60 °C	18.82	-20.43	-14.97	18.50	0.65	-21.29	-16.00	18.17	-19.42	-17.03
85 °C	18.70	-19.82	-14.71	18.38	0.65	-20.39	-15.70	18.05	-18.70	-16.72

2. OIP3, P1dB & NF

	890 MHz			925 MHz			960 MHz		
	OIP3 (dBm)	P1dB (dBm)	NF (dB)	OIP3 (dBm)	P1dB (dBm)	NF (dB)	OIP3 (dBm)	P1dB (dBm)	NF (dB)
-45 °C	31.95	16.72	0.414	31.99	15.96	0.385	32.14	15.72	0.399
-10 °C	30.90	16.95	0.502	30.82	16.45	0.492	31.15	16.33	0.541
25 °C	30.15	16.65	0.694	29.96	16.68	0.683	30.33	16.65	0.720
60 °C	29.93	17.07	0.824	29.75	16.71	0.825	30.20	16.74	0.845
85 °C	30.31	16.90	0.943	30.17	16.60	0.938	30.60	16.79	0.981

Note: tested at $V_s = 5V$.

Application Circuit

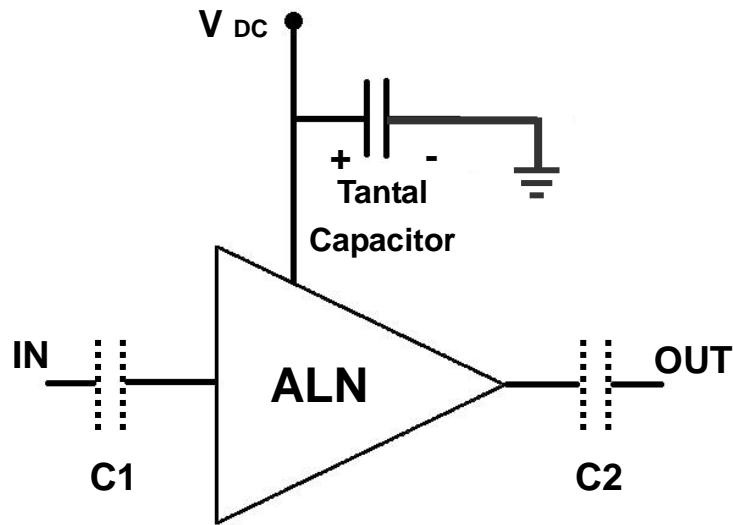

- 1) The tantal capacitor is optional and for bypassing the AC noise introduced from the DC supply. The capacitance value may be determined by customer's DC supply status.
- 2) So-called DC blocking capacitors are always necessarily placed at the input and output port for allowing only the RF signal to pass and blocking the DC component in the signal. The DC blocking capacitors are included inside the LNA module. Therefore, C1 & C2 capacitors may not be necessary, but can be added just in case that the customer wants. The value of C1 & C2 is determined by considering the application frequency.

Recommended Soldering Reflow Process

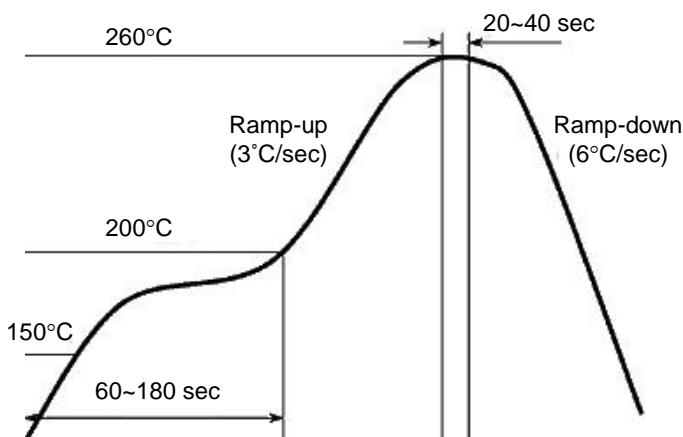

Evaluation Board Layout

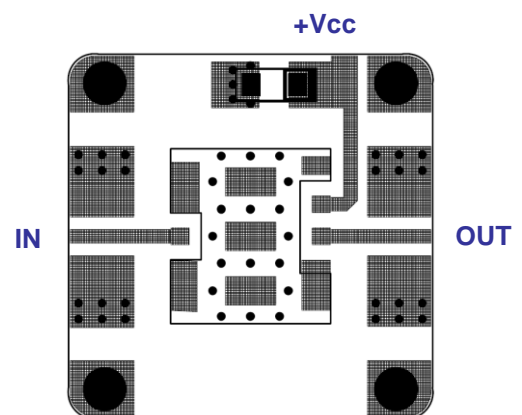

Size 25 x 25mm
(for ALN-AT, BT, T Series – 10x10mm)