



General Description

The QN3107M6N is the highest performance trench N-Channel MOSFET with extreme high cell density, which provide excellent RDSON and gate charge for most of the synchronous buck converter applications.

The QN3107M6N meet the RoHS and Green Product requirement with full function reliability approved.

Features

- Advanced high cell density Trench technology
- Super Low Gate Charge
- Green Device Available

Product Summary

BVDSS	RDSON (VGS=10V)	ID (Tc=25°C)
30V	2.6mΩ	118A

Applications

- High Frequency Point-of-Load Synchronous Buck Converter for MB/NB/UMPC/VGA
- Networking DC-DC Power System
- Load Switch

PRPAK 5X6 Pin Configuration

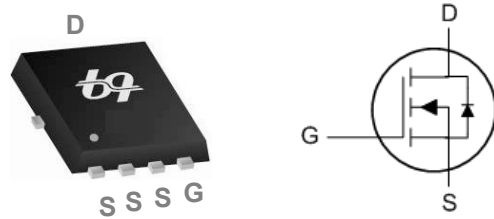

Absolute Maximum Ratings

Symbol	Parameter	Rating	Units
V _{DS}	Drain-Source Voltage	30	V
V _{GS}	Gate-Source Voltage	±20	V
I _D @T _C =25°C	Continuous Drain Current, V _{GS} @ 10V ¹	118	A
I _D @T _C =100°C	Continuous Drain Current, V _{GS} @ 10V ¹	74	A
I _D @T _A =25°C	Continuous Drain Current, V _{GS} @ 10V ¹	22	A
I _D @T _A =70°C	Continuous Drain Current, V _{GS} @ 10V ¹	17	A
I _{DM}	Pulsed Drain Current ²	236	A
EAS	Single Pulse Avalanche Energy ³	155.1	mJ
I _{AS}	Avalanche Current	55.7	A
P _D @T _C =25°C	Total Power Dissipation ⁴	56	W
P _D @T _A =25°C	Total Power Dissipation ⁴	2.0	W
T _{STG}	Storage Temperature Range	-55 to 150	°C
T _J	Operating Junction Temperature Range	-55 to 150	°C

Thermal Data

Symbol	Parameter	Typ.	Max.	Unit
R _{θJA}	Thermal Resistance Junction-Ambient ¹	44	62	°C/W
R _{θJC}	Thermal Resistance Junction-Case ¹	2.2	2.5	°C/W

Electrical Characteristics ($T_J=25^\circ\text{C}$, unless otherwise noted)

Symbol	Parameter	Conditions	Min.	Typ.	Max.	Unit
BV_{DSS}	Drain-Source Breakdown Voltage	$V_{GS}=0V, I_D=250\mu A$	30	---	---	V
$\Delta BV_{DSS}/\Delta T_J$	BVDSS Temperature Coefficient	Reference to 25°C , $I_D=1\text{mA}$	---	0.01	---	$V/^\circ\text{C}$
$R_{DS(ON)}$	Static Drain-Source On-Resistance ²	$V_{GS}=10V, I_D=30A$	---	2.1	2.6	m Ω
		$V_{GS}=4.5V, I_D=15A$	---	2.9	3.8	
$V_{GS(th)}$	Gate Threshold Voltage	$V_{GS}=V_{DS}, I_D=250\mu A$	1.2	---	2.5	V
$\Delta V_{GS(th)}$	$V_{GS(th)}$ Temperature Coefficient		---	-4.6	---	$\text{mV}/^\circ\text{C}$
I_{DSS}	Drain-Source Leakage Current	$V_{DS}=24V, V_{GS}=0V, T_J=25^\circ\text{C}$	---	---	1	μA
		$V_{DS}=24V, V_{GS}=0V, T_J=55^\circ\text{C}$	---	---	5	
I_{GSS}	Gate-Source Leakage Current	$V_{GS}=\pm 20V, V_{DS}=0V$	---	---	± 100	nA
gfs	Forward Transconductance	$V_{DS}=5V, I_D=15A$	---	47.5	---	S
R_g	Gate Resistance	$V_{DS}=0V, V_{GS}=0V, f=1\text{MHz}$	---	0.9	---	Ω
Q_g	Total Gate Charge (10V)	$V_{DS}=15V, V_{GS}=4.5V, I_D=15A$	---	31.4	---	nC
Q_g	Total Gate Charge (4.5V)		---	15.1	---	
Q_{gs}	Gate-Source Charge		---	5.4	---	
Q_{gd}	Gate-Drain Charge		---	5.2	---	
$T_{d(on)}$	Turn-On Delay Time	$V_{DD}=15V, V_{GS}=10V, R_G=3.3\Omega$ $I_D=15A$	---	10.8	---	ns
T_r	Rise Time		---	44.6	---	
$T_{d(off)}$	Turn-Off Delay Time		---	25.3	---	
T_f	Fall Time		---	6.1	---	
C_{iss}	Input Capacitance	$V_{DS}=15V, V_{GS}=0V, f=1\text{MHz}$	---	1950	---	pF
C_{oss}	Output Capacitance		---	1120	---	
C_{rss}	Reverse Transfer Capacitance		---	42	---	

Guaranteed Avalanche Characteristics

Symbol	Parameter	Conditions	Min.	Typ.	Max.	Unit
EAS	Single Pulse Avalanche Energy ⁵	$V_{DD}=25V, L=0.1\text{mH}, I_{AS}=35A$	61.25	---	---	mJ

Diode Characteristics

Symbol	Parameter	Conditions	Min.	Typ.	Max.	Unit
I_S	Continuous Source Current ^{1,6}	$V_G=V_D=0V$, Force Current	---	---	118	A
I_{SM}	Pulsed Source Current ^{2,6}		---	---	236	A
V_{SD}	Diode Forward Voltage ²	$V_{GS}=0V, I_S=1A, T_J=25^\circ\text{C}$	---	---	1.2	V
trr	Reverse Recovery Time	$I_F=15A, di/dt=100A/\mu s, T_J=25^\circ\text{C}$	---	73.6	---	nS
Qrr	Reverse Recovery Charge		---	62.3	---	nC

Note :

- The data tested by surface mounted on a 1 inch² FR-4 board with 20Z copper.
- The data tested by pulsed, pulse width $\leq 300\mu s$, duty cycle $\leq 2\%$
- The EAS data shows Max. rating. The test condition is $V_{DD}=25V, V_{GS}=10V, L=0.1\text{mH}$
- The power dissipation is limited by 150°C junction temperature
- The Min. value is 100% EAS tested guarantee.
- The data is theoretically the same as I_D and I_{DM} , in real applications, should be limited by total power dissipation.

Typical Characteristics

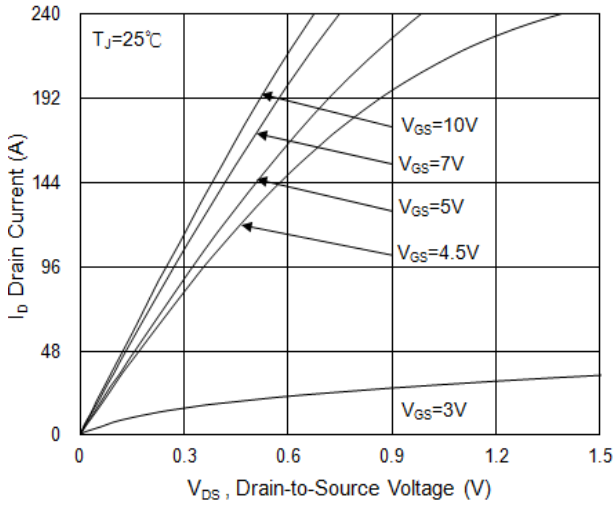

Fig.1 Typical Output Characteristics

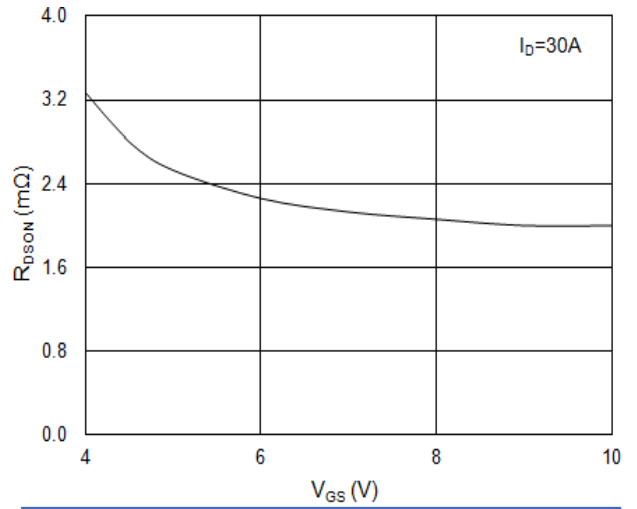

Fig.2 On-Resistance vs. Gate-Source

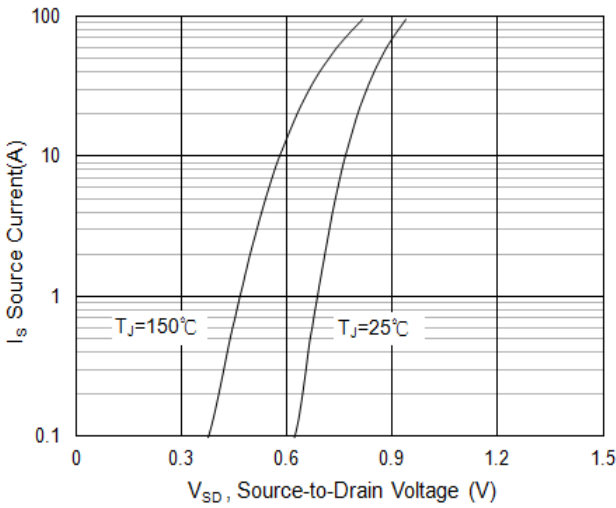

Fig.3 Forward Characteristics of Reverse

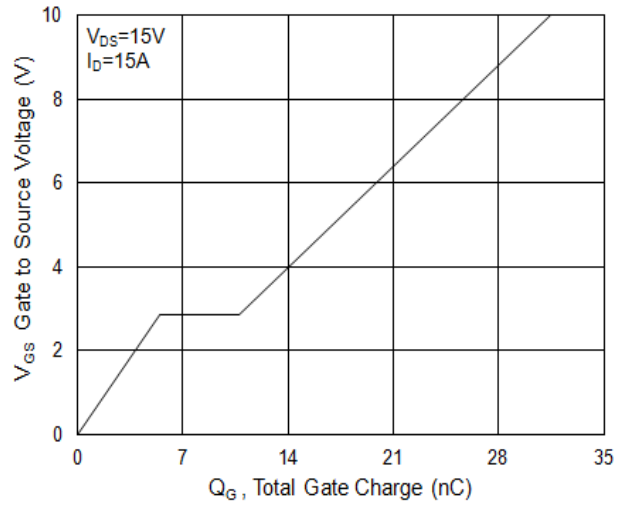

Fig.4 Gate-Charge Characteristics

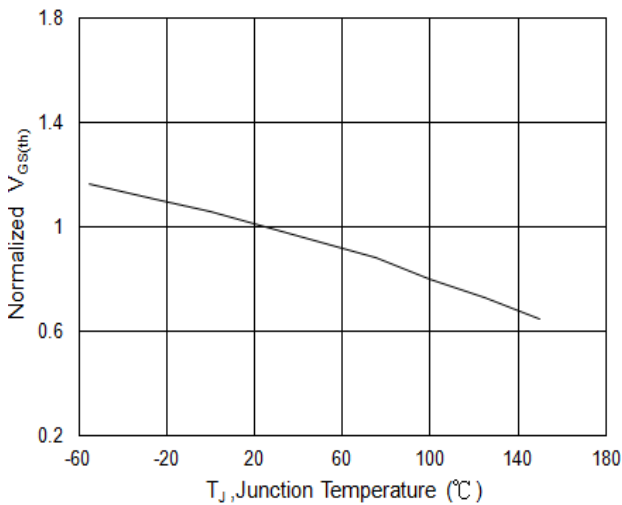

Fig.5 Normalized $V_{GS(th)}$ vs. T_J

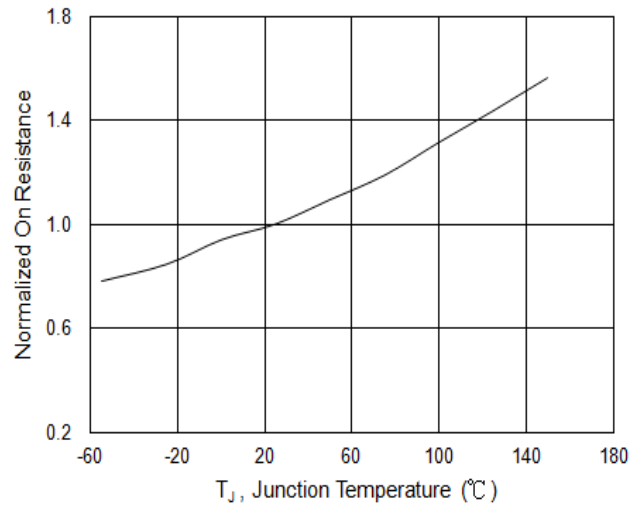

Fig.6 Normalized $R_{DS(on)}$ vs. T_J

N-Channel 30V Fast Switching MOSFET

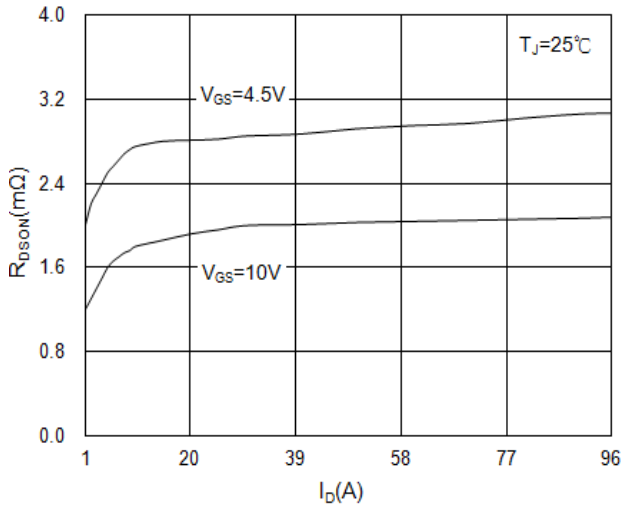

Fig.7 Drain-Source On-State Resistance

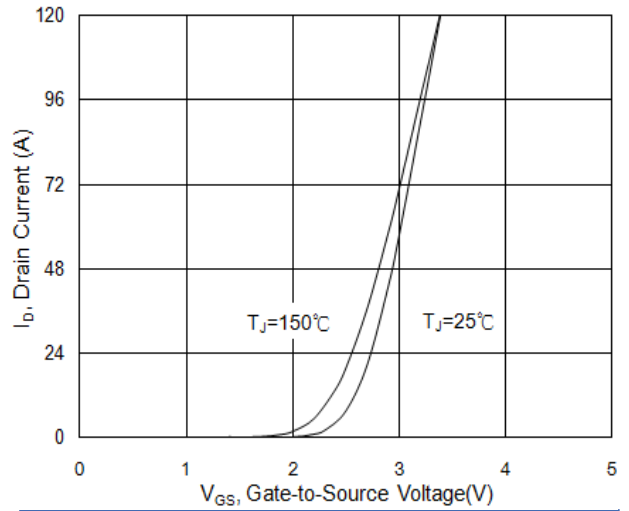

Fig.8 Transfer Characteristics

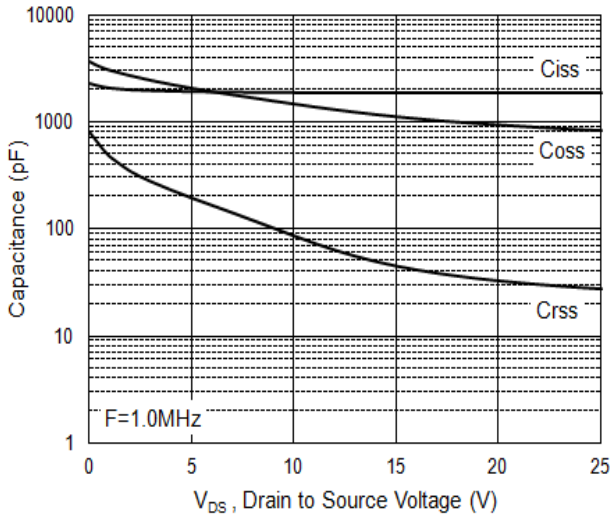

Fig.9 Capacitance

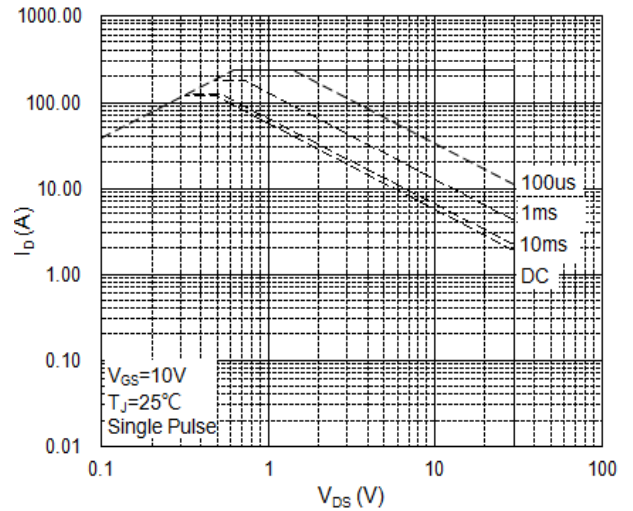

Fig.10 Safe Operating Area

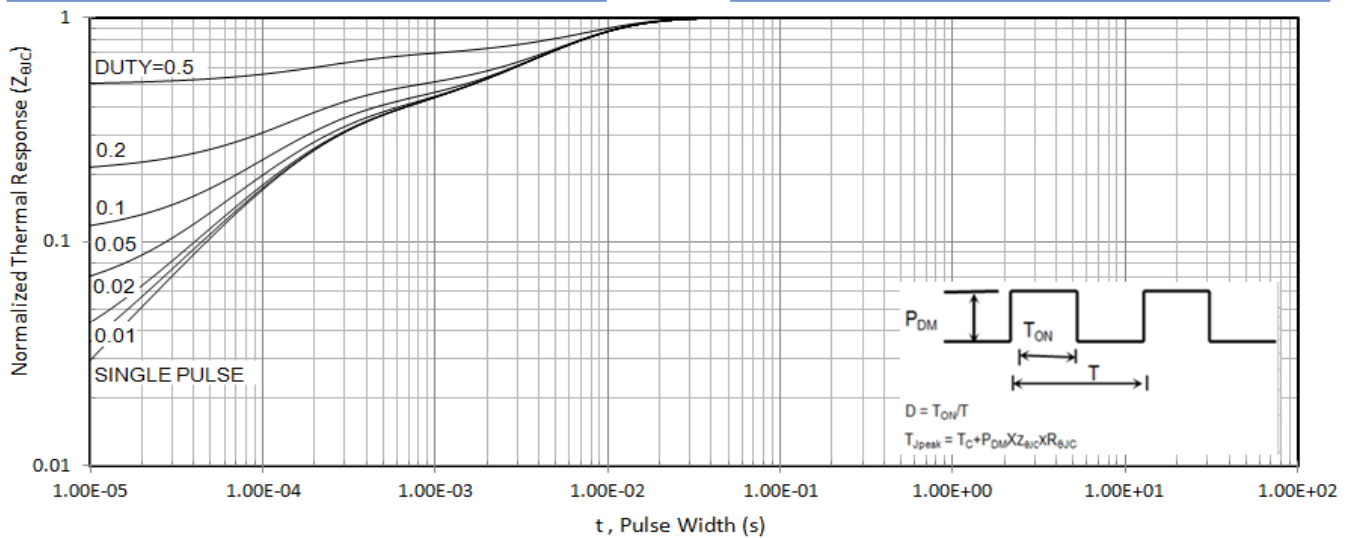
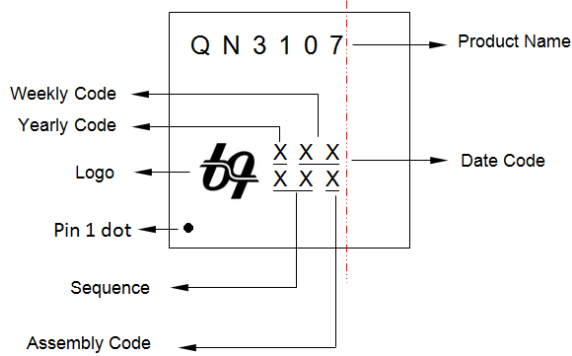
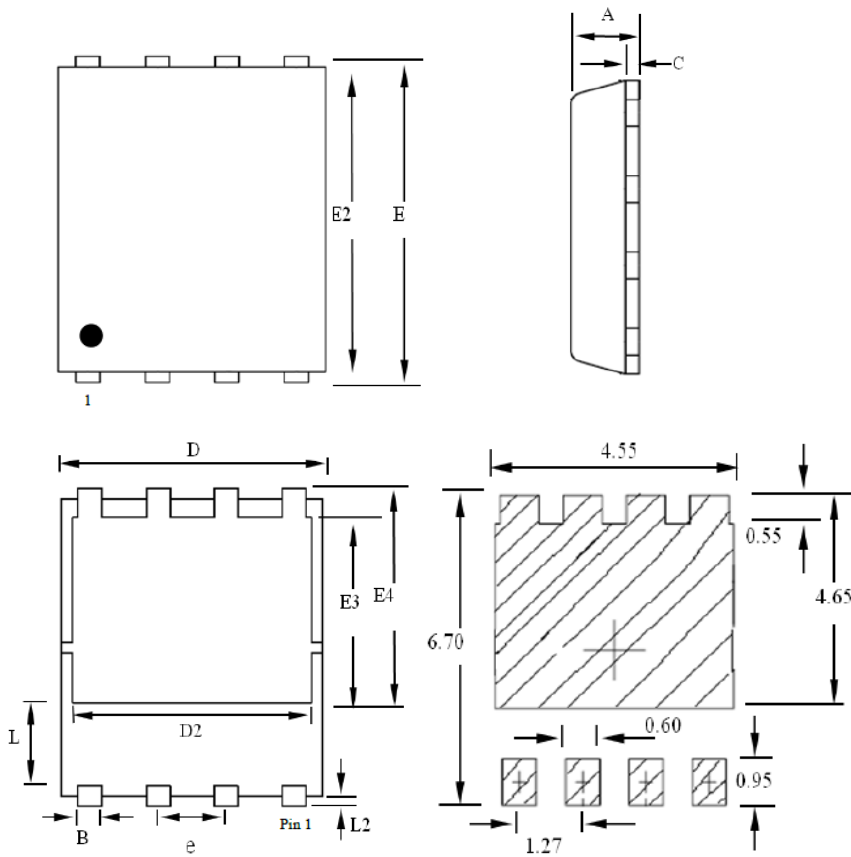

Fig.11 Transient Thermal Impedance

Top Marking



PRPAK5X6 Package Outline Drawing



SYMBOLS	Millimeters		
	MIN	NOM	MAX
A	0.90	1.00	1.20
B	0.33	--	0.51
C	0.20	--	0.34
D	4.50	--	5.10
D2	3.60	--	4.22
E	5.90	--	6.13
E2	5.50	--	5.84
E3	3.18	--	4.30
E4	3.69	--	4.39
L	1.10	--	1.39
L2	0.02	--	0.33
e	--	1.27	--

LAND PATTERN RECOMMENDATION (Unit : mm)

Note:

1. ALL DIMENSIONS LISTED ON THE DRAWING MEETING JEDEC STANDARD.
2. PACKAGE BODY SIZES EXCLUDE MOLD FLASH AND GATE BURRS.
3. RECOMMENDED LAND PATTERN DESIGN IS ONLY FOR REFERENCE