

TLP751

Digital Logic Ground Isolation
 Line Receiver
 Microprocessor System Interfaces
 Switching Power Supply Feedback Control
 Analog Signal Isolation

The TOSHIBA TLP751 consists of GaAlAs high-output light emitting diode and a high speed detector of one chip photo diode-transistor. This unit is 8-lead DIP.

TLP751 has internal base connection. This base pin should be used for analog application or enable operation. If base pin is open, output signal will be noisy by environmental condition. For this case, TLP750 is suitable.

- Switching speed: $t_{pHL} = 0.3\mu s$ (typ.)
 $t_{pLH} = 0.5\mu s$ (typ.) ($R_L = 1.9k\Omega$)
- TTL compatible
- UL recognized: UL1577, file no. E67349
- BSI approved: BS EN60065: 1994,
 Certificate no. 7613
 BS EN60950: 1992,
 Certificate no. 7614
- Isolation voltage: 5000Vrms(min.)
- Option(D4)type
 VDE approved: DIN VDE0884 / 06.92,
 Certificate no. 68384
 Maximum operating insulation voltage: 890V_{PK}
 Highest permissible over voltage: 8000V_{PK}

(Note) When a VDE0884 approved type is needed, please designate the "Option(D4)"

- Creepage distance: 6.4mm(min.)
 Clearance: 6.4mm(min.)
 Insulation thickness: 0.4mm(min.)

Unit in mm

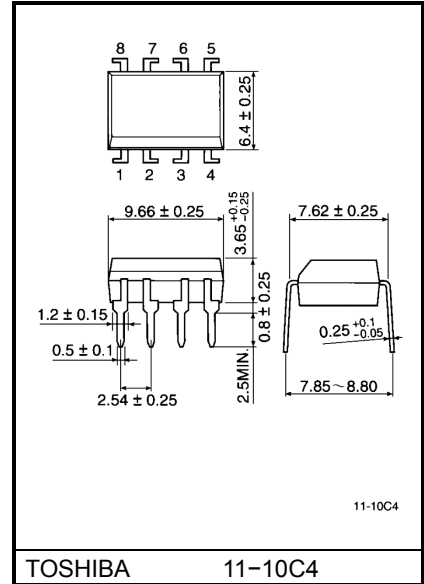

Weight: 0.54g

Pin Configuration(top view)

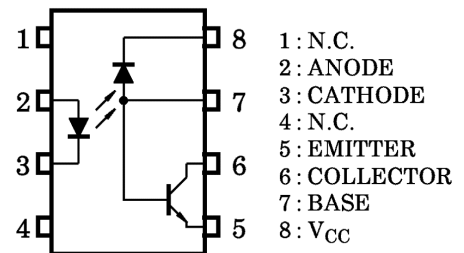

Schematic

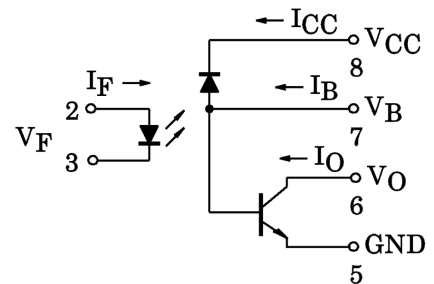

Maximum Ratings (Ta = 25°C)

Characteristic		Symbol	Rating	Unit
LED	Forward current (Note 1)	I_F	25	mA
	Pulse forward current (Note 2)	I_{FP}	50	mA
	Peak transient forward current (Note 3)	I_{FPT}	1	A
	Reverse voltage	V_R	5	V
	Diode power dissipation (Note 4)	P_D	45	mW
Detector	Output current	I_O	8	mA
	Peak output current	I_{OP}	16	mA
	Output voltage	V_O	-0.5~15	V
	Supply voltage	V_{CC}	-0.5~15	V
	Base current	I_B	5	mA
	Output power dissipation (Note 5)	P_O	100	mW
	Emitter-base reverse voltage	V_{EB}	5	V
Operating temperature range		T_{opr}	-55~100	°C
Storage temperature range		T_{stg}	-55~125	°C
Lead solder temperature(10s) (Note 6)		T_{sol}	260	°C
Isolation voltage (AC, 1min., R.H. ≤ 60%) (Note 7)		BV_S	5000	Vrms

(Note 1) Derate 0.8mA above 70°C

(Note 2) 50% duty cycle, 1ms pulse width.

Derate 1.6mA / °C above 70°C

(Note 3) Pulse width ≤ 1μs, 300pps.

(Note 4) Derate 0.9mW / °C above 70°C

(Note 5) Derate 2mW / °C above 70°C

(Note 6) Soldering portion of lead : up to 2mm from the body of the device.

(Note 7) Device considered a two terminal device: Pins 1,2,3 and 4 shorted together and pins 5,6,7 and 8 shorted together.

Electrical Characteristics (Ta = 25°C)

Characteristic		Symbol	Test Condition	Min.	Typ.	Max.	Unit
LED	Forward voltage	V_F	$I_F = 16 \text{ mA}$	—	1.65	1.85	V
	Forward voltage Temperature coefficient	$\Delta V_F / \Delta T_a$	$I_F = 16 \text{ mA}$	—	-2	—	mV / °C
	Reverse current	I_R	$V_R = 5 \text{ V}$	—	—	10	μA
	Capacitance between terminal	CT	$V_F = 0, f = 1 \text{ MHz}$	—	45	—	pF
Detector	High level output current	$I_{OH(1)}$	$I_F = 0 \text{ mA}, V_{CC} = V_O = 5.5 \text{ V}$	—	3	500	nA
		$I_{OH(2)}$	$I_F = 0 \text{ mA}, V_{CC} = V_O = 15 \text{ V}$	—	—	5	μA
		I_{OH}	$I_F = 0 \text{ mA}, V_{CC} = V_O = 15 \text{ V}$ $T_a = 70^\circ\text{C}$	—	—	50	
High level supply voltage	I_{CCH}	$I_F = 0 \text{ mA}, V_{CC} = 15 \text{ V}$	—	0.01	1	μA	
Coupled	Current transfer ratio	I_O / I_F	$I_F = 16 \text{ mA}, V_{CC} = 4.5 \text{ V}$ $V_O = 0.4 \text{ V}$	10	30	—	%
	Low level output voltage	V_{OL}	$I_F = 16 \text{ mA}, V_{CC} = 4.5 \text{ V}$ $I_O = 1.1 \text{ mA}$	—	—	0.4	V
	resistance(input-output)	R_S	R.H. $\leq 60\%$, $V_S = 500 \text{ V}_{DC}$ (Note7)	1×10^{12}	10^{14}	—	Ω
	Capacitance (input-output)	C_S	$V_S = 0, f = 1 \text{ MHz}$ (Note7)	—	0.8	—	pF

Switching Characteristics (Ta = 25°C, VCC = 5V)

Characteristic	Symbol	Test Circuit	Test Condition	Min.	Typ.	Max.	Unit
Propagation delay time (H→L)	t_{pHL}	1	$I_F = 0 \rightarrow 16 \text{ mA}, V_{CC} = 5 \text{ V}, R_L = 4.1 \text{ k}\Omega$	—	0.2	—	μs
Propagation delay time (L→H)	t_{pLH}			—	1.0	—	μs
Common mode transient immunity at logic high output (Note 8)	CM_H	2	$I_F = 0 \text{ mA}, V_{CM} = 200 \text{ V}_{p-p}$ $R_L = 4.1 \text{ k}\Omega$	—	400	—	V / μs
Common mode transient immunity at logic low output (Note 8)	CM_L			$I_F = 16 \text{ mA}$ $V_{CM} = 200 \text{ V}_{p-p}$ $R_L = 4.1 \text{ k}\Omega$	—	-1000	—

(Note 8) CM_L is the maximum rate of fall of the common mode voltage that can be sustained with the output voltage in the logic low state ($V_O < 0.8V$).

CM_H is the maximum rate of rise of the common mode voltage that can be sustained with the output voltage in the logic high state ($V_O > 2.0V$).

(Note 9) Maximum electrostatic discharge voltage for any pins: 100V ($C = 200pF, R = 0$).

Test Circuit 1 : Switching Time Test Circuit

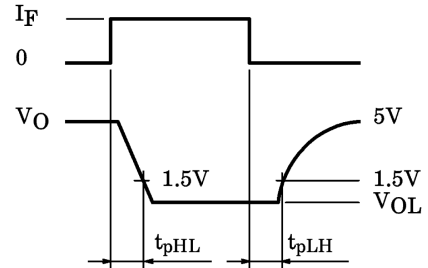
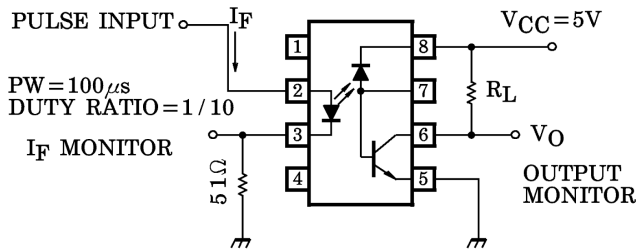

Test Circuit 2 : Common Mode Noise Immunity Test Circuit

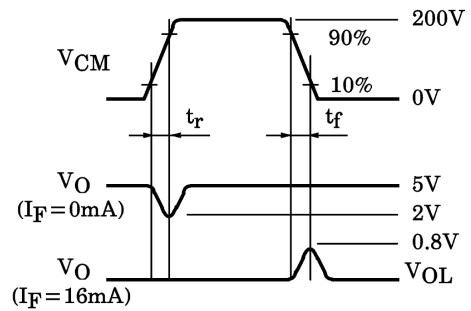
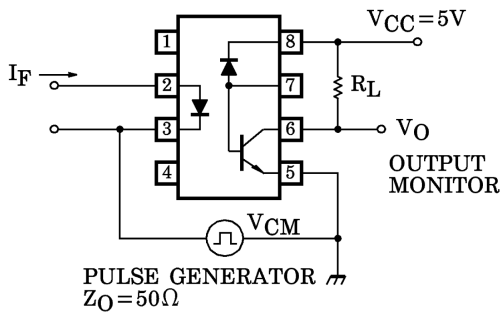

$$CM_H = \frac{160(V)}{t_r(\mu s)}, \quad CM_L = \frac{160(V)}{t_f(\mu s)}$$

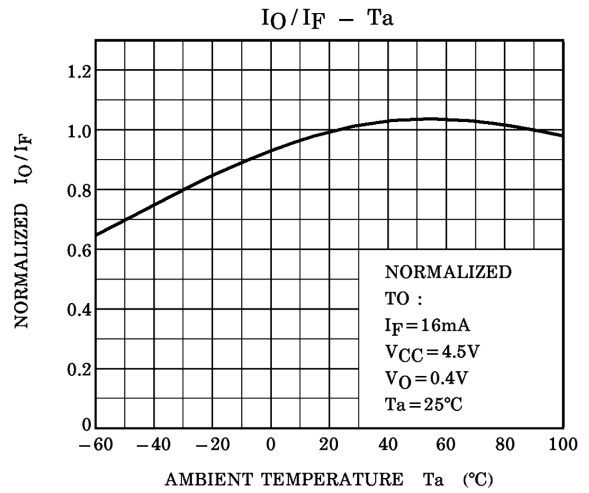
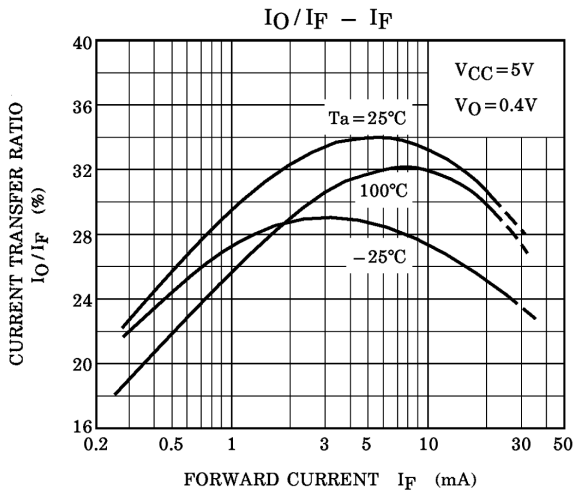
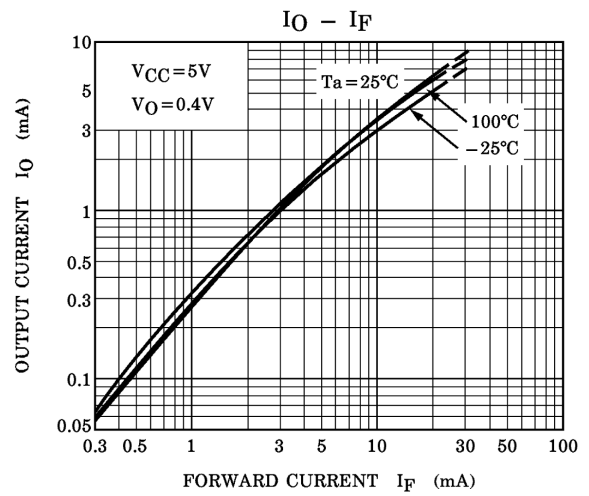
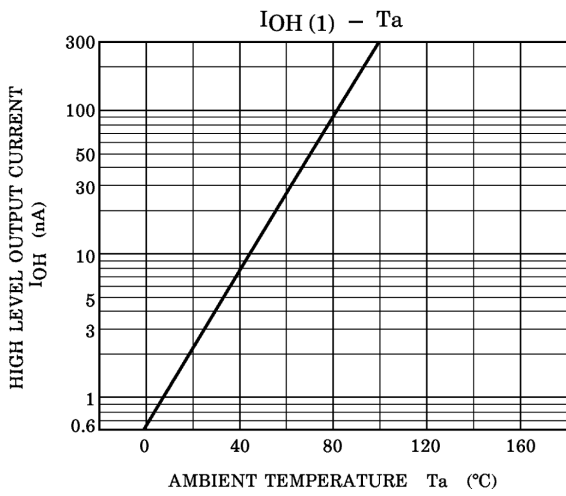
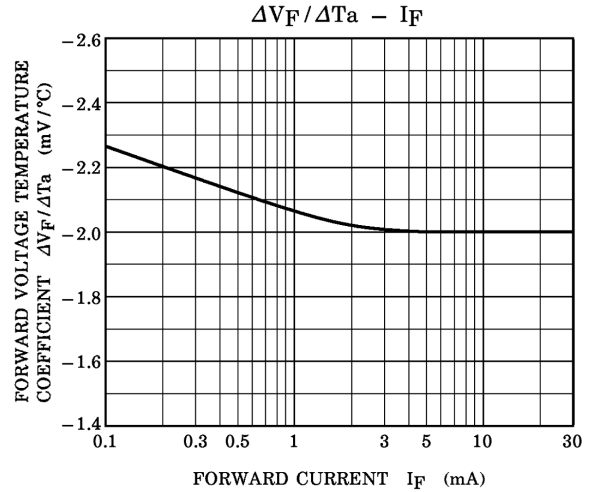
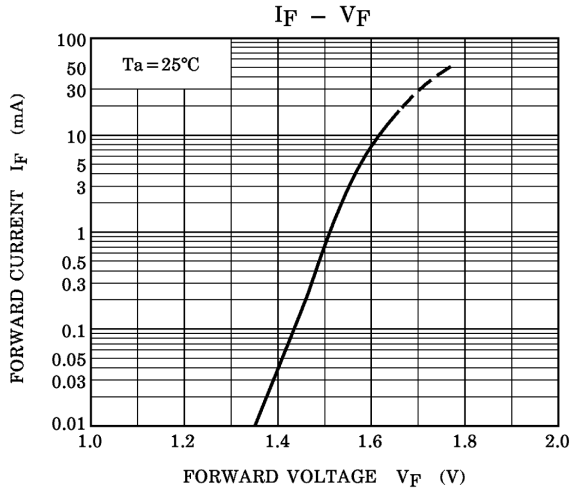

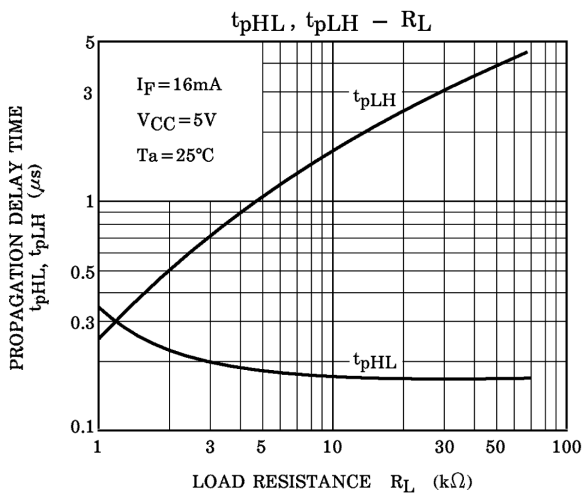
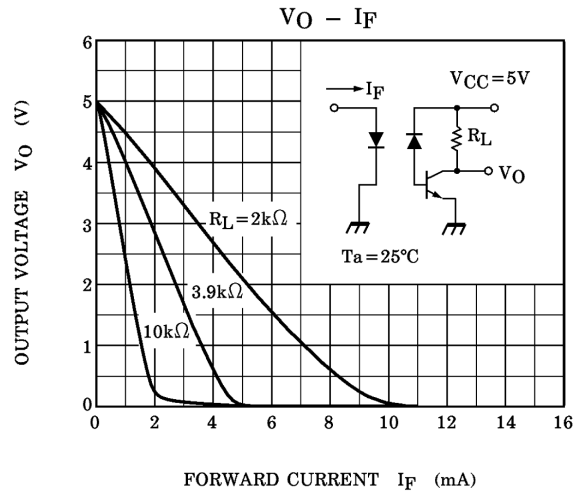
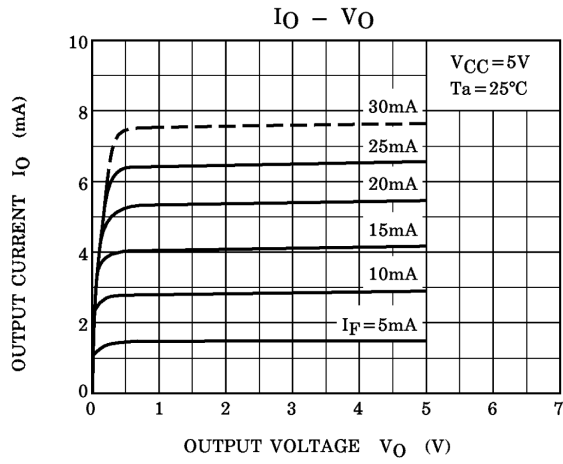

RESTRICTIONS ON PRODUCT USE

000707EBC

- TOSHIBA is continually working to improve the quality and reliability of its products. Nevertheless, semiconductor devices in general can malfunction or fail due to their inherent electrical sensitivity and vulnerability to physical stress. It is the responsibility of the buyer, when utilizing TOSHIBA products, to comply with the standards of safety in making a safe design for the entire system, and to avoid situations in which a malfunction or failure of such TOSHIBA products could cause loss of human life, bodily injury or damage to property.
In developing your designs, please ensure that TOSHIBA products are used within specified operating ranges as set forth in the most recent TOSHIBA products specifications. Also, please keep in mind the precautions and conditions set forth in the "Handling Guide for Semiconductor Devices," or "TOSHIBA Semiconductor Reliability Handbook" etc..
- The TOSHIBA products listed in this document are intended for usage in general electronics applications (computer, personal equipment, office equipment, measuring equipment, industrial robotics, domestic appliances, etc.). These TOSHIBA products are neither intended nor warranted for usage in equipment that requires extraordinarily high quality and/or reliability or a malfunction or failure of which may cause loss of human life or bodily injury ("Unintended Usage"). Unintended Usage include atomic energy control instruments, airplane or spaceship instruments, transportation instruments, traffic signal instruments, combustion control instruments, medical instruments, all types of safety devices, etc.. Unintended Usage of TOSHIBA products listed in this document shall be made at the customer's own risk.
- Gallium arsenide (GaAs) is a substance used in the products described in this document. GaAs dust and fumes are toxic. Do not break, cut or pulverize the product, or use chemicals to dissolve them. When disposing of the products, follow the appropriate regulations. Do not dispose of the products with other industrial waste or with domestic garbage.
- The products described in this document are subject to the foreign exchange and foreign trade laws.
- The information contained herein is presented only as a guide for the applications of our products. No responsibility is assumed by TOSHIBA CORPORATION for any infringements of intellectual property or other rights of the third parties which may result from its use. No license is granted by implication or otherwise under any intellectual property or other rights of TOSHIBA CORPORATION or others.
- The information contained herein is subject to change without notice.