

0.35-GHz TO 4-GHz QUADRATURE MODULATORS

Check for Samples: [TRF370315](#), [TRF370333](#)

FEATURES

- 75-dBc Single-Carrier WCDMA ACPR at –11-dBm Channel Power
- Low Noise Floor: –163 dBm/Hz
- OIP3 of 23 dBm
- P1dB of 9 dBm
- Unadjusted Carrier Feedthrough of –40 dBm
- Unadjusted Side-Band Suppression of –40 dBc
- Single Supply: 4.5 V–5.5 V Operation
- Silicon Germanium Technology
- TRF370333 With 3.3-V CM at I, Q Baseband Inputs
- TRF370315 With 1.5-V CM at I, Q Baseband Inputs

APPLICATIONS

- Cellular Base Transceiver Station Transmit Channel
- CDMA: IS95, UMTS, CDMA2000, TD-SCDMA
- TDMA: GSM, IS-136, EDGE/UWC-136
- Wireless Local Loop
- Wireless MAN Wideband Transceivers

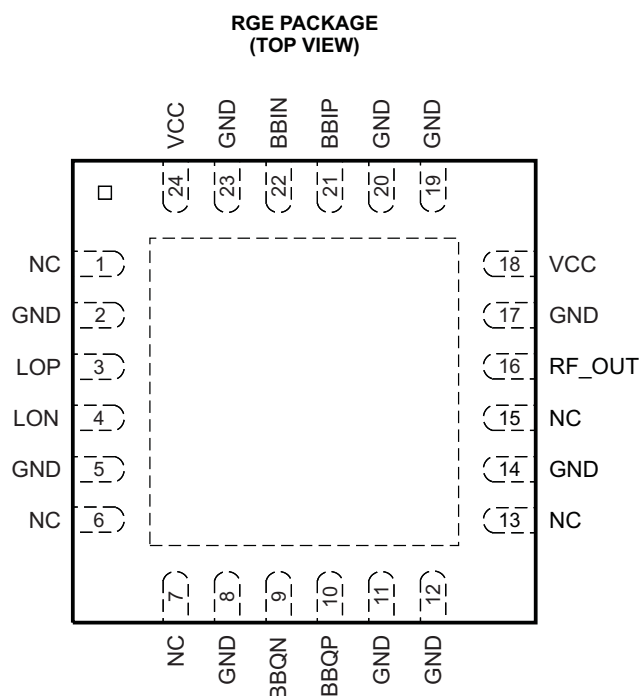

P0024-04

DESCRIPTION

The TRF370315 and TRF370333 are low-noise direct quadrature modulators, capable of converting complex modulated signals from baseband or IF directly up to RF. The TRF370315 and TRF370333 are ideal for high-performance direct RF modulation from 350 MHz up to 4 GHz. These modulators are implemented as a double-balanced mixer. The RF output block consists of a differential to single-ended converter and an RF amplifier capable of driving a single-ended 50-Ω load without any need of external components. The TRF370333 and TRF370315 devices have different common-mode voltage ratings at the I/Q baseband inputs. The TRF370315 requires a 1.5-V common-mode voltage, and the TRF370333 requires a 3.3-V common-mode voltage.



Please be aware that an important notice concerning availability, standard warranty, and use in critical applications of Texas Instruments semiconductor products and disclaimers thereto appears at the end of this data sheet.

All trademarks are the property of their respective owners.



This integrated circuit can be damaged by ESD. Texas Instruments recommends that all integrated circuits be handled with appropriate precautions. Failure to observe proper handling and installation procedures can cause damage.

ESD damage can range from subtle performance degradation to complete device failure. Precision integrated circuits may be more susceptible to damage because very small parametric changes could cause the device not to meet its published specifications.

FUNCTIONAL BLOCK DIAGRAM

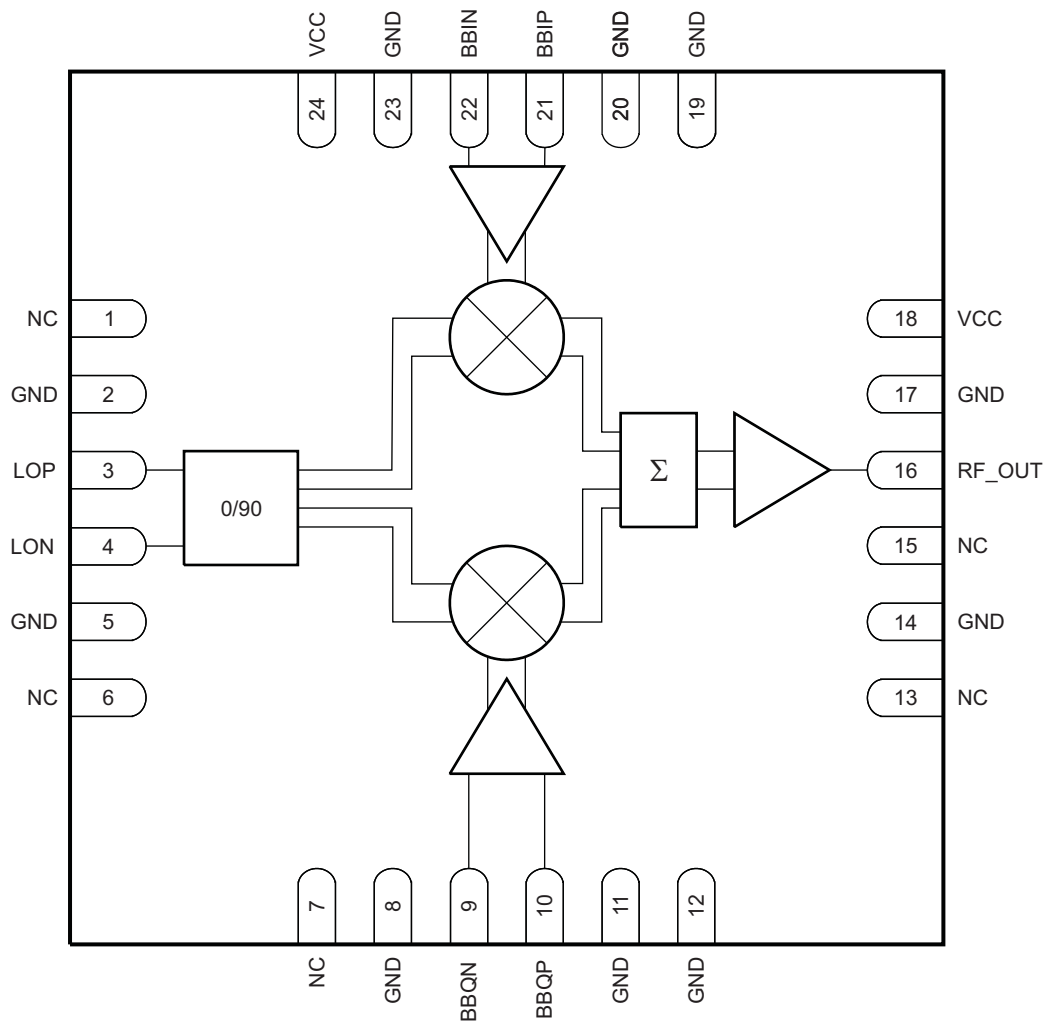

B0175-01

NOTE: NC = No connection

DEVICE INFORMATION
TERMINAL FUNCTIONS

TERMINAL		I/O	DESCRIPTION
NAME	NO.		
BBIN	22	I	In-phase input
BBIP	21	I	In-phase input
BBQN	9	I	In-quadrature input
BBQP	10	I	In-quadrature input
GND	2, 5, 8, 11, 12, 14, 17, 19, 20, 23	–	Ground
LON	4	I	Local oscillator input
LOP	3	I	Local oscillator input
NC	1, 6, 7, 13, 15	–	No connect
RF_OUT	16	O	RF output
VCC	18, 24	–	Power supply

ABSOLUTE MAXIMUM RATINGS⁽¹⁾

Over operating free-air temperature range (unless otherwise noted).

		VALUE ⁽²⁾	UNIT	
Supply voltage range		–0.3 V to 6	V	
Digital I/O voltage range		–0.3 V to $V_I + 0.3$	V	
T_J	Operating virtual junction temperature range	–40 to 150	°C	
T_A	Operating ambient temperature range	–40 to 85	°C	
T_{stg}	Storage temperature range	–65 to 150	°C	
ESD	Electrostatic discharge ratings	Human body model (HBM)	75	V
		Charged device model (CDM)	75	V

- (1) Stresses beyond those listed under *Absolute Maximum Ratings* may cause permanent damage to the device. These are stress ratings only, and functional operation of the device at these or any other conditions beyond those indicated under *Recommended Operating Conditions* is not implied. Exposure to absolute-maximum-rated conditions for extended periods may affect device reliability.
- (2) All voltage values are with respect to network ground terminal.

RECOMMENDED OPERATING CONDITIONS

Over operating free-air temperature range (unless otherwise noted).

		MIN	NOM	MAX	UNIT
V_{CC}	Power-supply voltage	4.5	5	5.5	V

THERMAL CHARACTERISTICS

PARAMETER		TEST CONDITIONS	VALUE	UNIT
$R_{\theta JA}$	Thermal resistance, junction-to-ambient	High-K board, still air	29.4	°C/W
$R_{\theta JC}$	Thermal resistance, junction-to-case		18.6	°C/W

ELECTRICAL CHARACTERISTICS

Over operating free-air temperature range (unless otherwise noted).

PARAMETER		TEST CONDITIONS	MIN	TYP	MAX	UNIT
DC Parameters						
I _{CC}	Total supply current (1.5 V CM)	T _A = 25°C		195	205	mA
	Total supply current (3.3 V CM)	T _A = 25°C		210	235	
LO Input (50-Ω, Single-Ended)						
f _{LO}	LO frequency range		0.35		4	GHz
	LO input power		-5	0	12	dBm
	LO port return loss			15		dB
Baseband Inputs						
V _{CM}	I and Q input dc common voltage	TRF370333		3.3		V
		TRF370315		1.5		
BW	1-dB input frequency bandwidth		350			MHz
Z _(single ended)	Input impedance, resistance	TRF370333		10		kΩ
	Input impedance, parallel capacitance			3		pF
	Input impedance, resistance	TRF370315		5		kΩ
	Input impedance, parallel capacitance			3		pF

ELECTRICAL CHARACTERISTICS

Over recommended operating conditions, power supply = 5 V, T_A = 25°C, f_{LO} = **350 MHz** at 0 dBm, TRF370333 (unless otherwise noted).

RF Output Parameters						
PARAMETER		TEST CONDITIONS	MIN	TYP	MAX	UNIT
G	Voltage gain ⁽¹⁾	TRF370315: Output RMS voltage over input I (or Q) RMS voltage		-4.18		dB
		TRF370333: Output RMS voltage over input I (or Q) RMS voltage		-4.0		dB
P1dB	Output compression point			9.4		dBm
IP3	Output IP3			24.5		dBm
IP2	Output IP2	Measured at f _{LO} + 2 × f _{BB}		73.8		dBm
	Carrier feedthrough	Unadjusted		35.6		dBm
	Sideband suppression	Unadjusted		33.8		dBc
Output noise floor		DC only to BB inputs, 13 MHz offset from f _{LO}		-158.0		dBm/Hz
		1.8-MHz offset from f _{LO} ; 1 CW tone; P _{out} = 0 dBm		-152.6		
		6-MHz offset from f _{LO} ; 1 CW tone; P _{out} = 0 dBm		-157.4		

(1) Single 4-MHz CW baseband input tone, differential-ended 196 V_{RMS}.

ELECTRICAL CHARACTERISTICS

Over recommended operating conditions, power supply = 5 V, T_A = 25°C, f_{LO} = **400 MHz** at 0 dBm, TRF370315 (unless otherwise noted).

RF Output Parameters						
PARAMETER		TEST CONDITIONS	MIN	TYP	MAX	UNIT
G	Voltage gain ⁽¹⁾	TRF370315: Output RMS voltage over input I (or Q) RMS voltage		-2.409		dB
		TRF370333: Output RMS voltage over input I (or Q) RMS voltage		-1.905		dB
P1dB	Output compression point			9.4		dBm
IP3	Output IP3		20	23		dBm
IP2	Output IP2	Measured at f _{LO} + 2 × f _{BB}		62		dBm
	Carrier feedthrough	Unadjusted		-37		dBm
	Sideband suppression	Unadjusted		-39		dBc

(1) Single 4-MHz CW baseband input tone, differential-ended 196 V_{RMS}.

ELECTRICAL CHARACTERISTICS

Over recommended operating conditions, power supply = 5 V, $T_A = 25^\circ\text{C}$, $f_{LO} = 900\text{ MHz}$ at 0 dBm, TRF370315 (unless otherwise noted).

RF Output Parameters					
PARAMETER	TEST CONDITIONS	MIN	TYP	MAX	UNIT
G	Voltage gain ⁽¹⁾	TRF370315: Output RMS voltage over input I (or Q) RMS voltage		-3.552	dB
		TRF370333: Output RMS voltage over input I (or Q) RMS voltage		-2.79	dB
P1dB	Output compression point		9		dBm
IP3	Output IP3	20	23		dBm
IP2	Output IP2	Measured at $f_{LO} + 2 \times f_{BB}$		63	dBm
	Carrier feedthrough	Unadjusted		-37	dBm
	Sideband suppression	Unadjusted		-42	dBc
	Output return loss		9		dB
	Output noise floor	DC only to BB inputs, 13 MHz offset from f_{LO}		-160.4	dBm/Hz
		1.8-MHz offset from f_{LO} ; 1 CW tone; $P_{out} = 0\text{ dBm}$		-156.6	
		6-MHz offset from f_{LO} ; 1 CW tone; $P_{out} = 0\text{ dBm}$		-158.5	
EVM	Error vector magnitude (rms)	1 EDGE signal, $P_{out} = -5\text{ dBm}$		0.59%	
		1 EDGE signal, $P_{out} = 0\text{ dBm}$		0.63%	
		1 EDGE signal, $P_{out} = 0\text{ dBm}$, 2nd harmonic of LO = -15 dBm, 3rd harmonic of LO = -33 dBm ⁽²⁾		1%	

(1) Single 4-MHz CW baseband input tone, differential-ended 196 V_{RMS} .

(2) The second- and third-harmonic tests were made independently at each frequency.

ELECTRICAL CHARACTERISTICS

Over recommended operating conditions, power supply = 5 V, $T_A = 25^\circ\text{C}$, $f_{LO} = 1800\text{ MHz}$ at 0 dBm, TRF370315 (unless otherwise noted).

RF Output Parameters					
PARAMETER	TEST CONDITIONS	MIN	TYP	MAX	UNIT
G	Voltage gain ⁽¹⁾	TRF370315: Output RMS voltage over input I (or Q) RMS voltage		-3.345	dB
		TRF370333: Output RMS voltage over input I (or Q) RMS voltage		-2.367	dB
P1dB	Output compression point		9.5		dBm
IP3	Output IP3	20	23		dBm
IP2	Output IP2	Measured at $f_{LO} + 2 \times f_{BB}$		55	dBm
	Carrier feedthrough	Unadjusted		-40	dBm
	Sideband suppression	Unadjusted		-47	dBc
	Output return loss		8		dB
	Output noise floor	DC only to BB inputs, 13 MHz offset from f_{LO}		-162.6	dBm/Hz
		1.8-MHz offset from f_{LO} ; 1 CW tone; $P_{out} = 0\text{ dBm}$		-160	
		6-MHz offset from f_{LO} ; 1 CW tone; $P_{out} = 0\text{ dBm}$		-159.4	
EVM	Error vector magnitude (rms)	1 EDGE signal, $P_{out} = -5\text{ dBm}$		0.66%	
		1 EDGE signal, $P_{out} = 0\text{ dBm}$		0.74%	
		1 EDGE signal, $P_{out} = 0\text{ dBm}$, 2nd harmonic of LO = -15.5 dBm, 3rd harmonic of LO = -30 dBm ⁽²⁾		1%	

(1) Single 4-MHz CW baseband input tone, differential-ended 196 V_{RMS} .

(2) The second- and third-harmonic tests were made independently at each frequency.

ELECTRICAL CHARACTERISTICS

Over recommended operating conditions, power supply = 5 V, $T_A = 25^\circ\text{C}$, $f_{LO} = 1960 \text{ MHz}$ at 0 dBm, TRF370315 (unless otherwise noted).

RF Output Parameters						
PARAMETER		TEST CONDITIONS	MIN	TYP	MAX	UNIT
G	Voltage gain ⁽¹⁾	TRF370315: Output RMS voltage over input I (or Q) RMS voltage		-3.449		dB
		TRF370333: Output RMS voltage over input I (or Q) RMS voltage		-2.479		dB
P1dB	Output compression point			9.5		dBm
IP3	Output IP3, TRF370315		20	23		dBm
	Output IP3, TRF370333		18	20		
IP2	Output IP2	Measured at $f_{LO} + 2 \times f_{BB}$		55		dBm
	Carrier feedthrough	Unadjusted		-40		dBm
	Sideband suppression	Unadjusted		-47		dBc
	Output return loss			8		dB
	Output noise floor	DC only to BB inputs, 13 MHz offset from f_{LO}		-162.6		dBm/Hz
		1.8-MHz offset from f_{LO} ; 1 CW tone; $P_{out} = 0 \text{ dBm}$		-160		
		6-MHz offset from f_{LO} ; 1 CW tone; $P_{out} = 0 \text{ dBm}$		-159.4		
EVM	Error vector magnitude (rms)	1 EDGE signal, $P_{out} = -5 \text{ dBm}$		0.66%		
		1 EDGE signal, $P_{out} = 0 \text{ dBm}$		0.74%		
		1 EDGE signal, $P_{out} = 0 \text{ dBm}$, 2nd harmonic of LO = -15.5 dBm, 3rd harmonic of LO = -30 dBm ⁽²⁾		1%		

(1) Single 4-MHz CW baseband input tone, differential-ended 196 V_{RMS} .

(2) The second- and third-harmonic tests were made independently at each frequency.

ELECTRICAL CHARACTERISTICS

Over recommended operating conditions, power supply = 5 V, $T_A = 25^\circ\text{C}$, $f_{LO} = 2140 \text{ MHz}$ at 0 dBm, TRF370315 (unless otherwise noted).

RF Output Parameters						
PARAMETER		TEST CONDITIONS	MIN	TYP	MAX	UNIT
G	Voltage gain ⁽¹⁾	TRF370315: Output RMS voltage over input I (or Q) RMS voltage		-3.432		dB
		TRF370333: Output RMS voltage over input I (or Q) RMS voltage		-2.791		dB
P1dB	Output compression point			9.5		dBm
IP3	Output IP3, TRF370315		20	23		dBm
	Output IP3, TRF370333		18	21		
IP2	Output IP2	Measured at $f_{LO} + 2 \times f_{BB}$		58		dBm
	Carrier feedthrough	Unadjusted		-40		dBm
	Sideband suppression	Unadjusted		-47		dBc
	Output return loss			8.5		dB
	Output noise floor	20-MHz offset from f_{LO} ; dc only to BB inputs		-163		dBm/Hz
		20-MHz offset from f_{LO} ; 1 WCDMA signal; $P_{in} = -20.5 \text{ dBVrms}$ (I and Q input)		-162		
ACPR	Adjacent-channel power ratio	1 WCDMA signal; $P_{out} = -13 \text{ dBm}$		-75.8		dBc
		1 WCDMA signal; $P_{out} = -9 \text{ dBm}$		-72		
		4 WCDMA signals; $P_{out} = -23 \text{ dBm}$ per carrier		-68		
	Alternate-channel power ratio	1 WCDMA signal; $P_{out} = -13 \text{ dBm}$		-79		dBc
		1 WCDMA signal; $P_{out} = -9 \text{ dBm}$		-80.5		
		4 WCDMA signals; $P_{out} = -23 \text{ dBm}$ per carrier		-69		

(1) Single 4-MHz CW baseband input tone, differential-ended 196 V_{RMS} .

ELECTRICAL CHARACTERISTICS

Over recommended operating conditions, power supply = 5 V, $T_A = 25^\circ\text{C}$, $f_{LO} = 2500\text{ MHz}$ at 0 dBm, TRF370315 (unless otherwise noted).

RF Output Parameters					
PARAMETER	TEST CONDITIONS	MIN	TYP	MAX	UNIT
G	Voltage gain ⁽¹⁾	TRF370315: Output RMS voltage over input I (or Q) RMS voltage		-2.892	dB
		TRF370333: Output RMS voltage over input I (or Q) RMS voltage		-1.379	dB
P1dB	Output compression point		9.5		dBm
IP3	Output IP3	18	21		dBm
IP2	Output IP2	Measured at $f_{LO} + 2 \times f_{BB}$		63	dBm
	Carrier feedthrough	Unadjusted		-38	dBm
	Sideband suppression	Unadjusted		-47	dBc

(1) Single 4-MHz CW baseband input tone, differential-ended 196 V_{RMS} .

ELECTRICAL CHARACTERISTICS

Over recommended operating conditions, power supply = 5 V, $T_A = 25^\circ\text{C}$, $f_{LO} = 3600\text{ MHz}$ at 0 dBm, TRF370315 (unless otherwise noted).

RF Output Parameters					
PARAMETER	TEST CONDITIONS	MIN	TYP	MAX	UNIT
G	Voltage gain ⁽¹⁾	TRF370315: Output RMS voltage over input I (or Q) RMS voltage		-1.265	dB
		TRF370333: Output RMS voltage over input I (or Q) RMS voltage		1.529	dB
P1dB	Output compression point		9.5		dBm
IP3	Output IP3	20	23		dBm
IP2	Output IP2	Measured at $f_{LO} + 2 \times f_{BB}$		63	dBm
	Carrier feedthrough	Unadjusted		-41	dBm
	Sideband suppression	Unadjusted		-45	dBc

(1) Single 4-MHz CW baseband input tone, differential-ended 196 V_{RMS} .

ELECTRICAL CHARACTERISTICS

Over recommended operating conditions, power supply = 5 V, $T_A = 25^\circ\text{C}$, $f_{LO} = 4000\text{ MHz}$ at 0 dBm, TRF370315 (unless otherwise noted).

RF Output Parameters					
PARAMETER	TEST CONDITIONS	MIN	TYP	MAX	UNIT
G	Voltage gain ⁽¹⁾	TRF370315: Output RMS voltage over input I (or Q) RMS voltage		-2.242	dB
		TRF370333: Output RMS voltage over input I (or Q) RMS voltage		0.543	dB
P1dB	Output compression point		9		dBm
IP3	Output IP3	19	22		dBm
IP2	Output IP2	Measured at $f_{LO} + 2 \times f_{BB}$		50	dBm
	Carrier feedthrough	Unadjusted		-37	dBm
	Sideband suppression	Unadjusted		-40	dBc

(1) Single 4-MHz CW baseband input tone, differential-ended 196 V_{RMS} .

TYPICAL CHARACTERISTICS

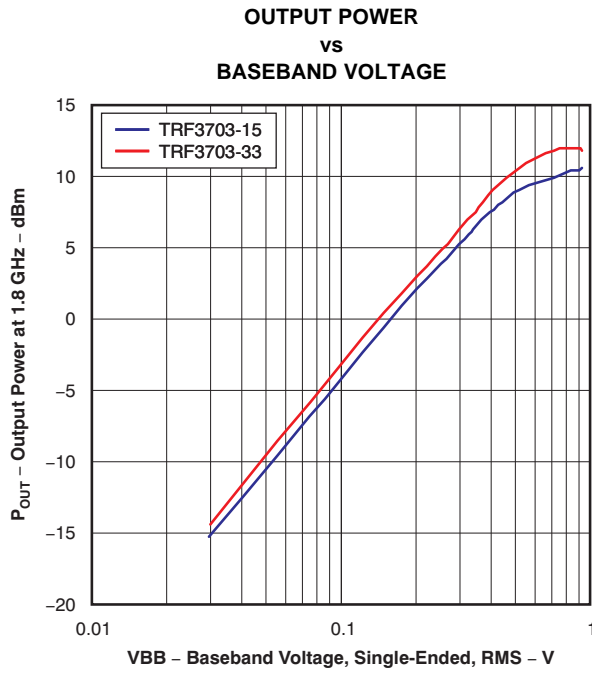

Figure 1.

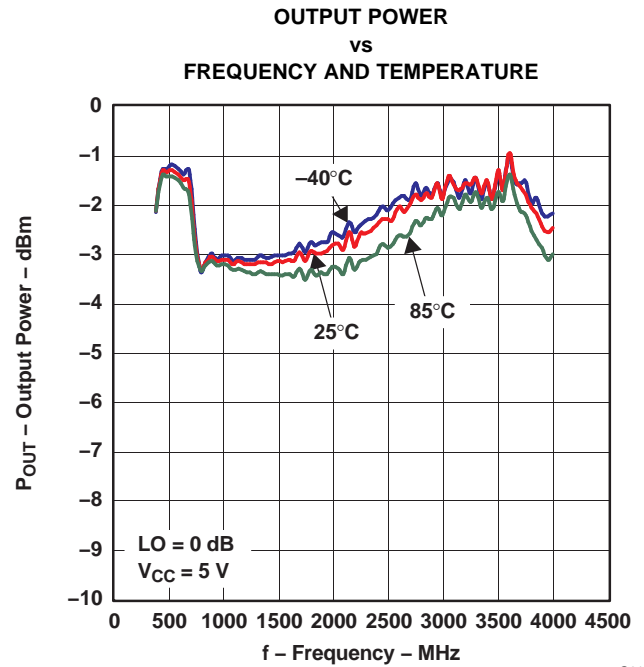

Figure 2.

G010

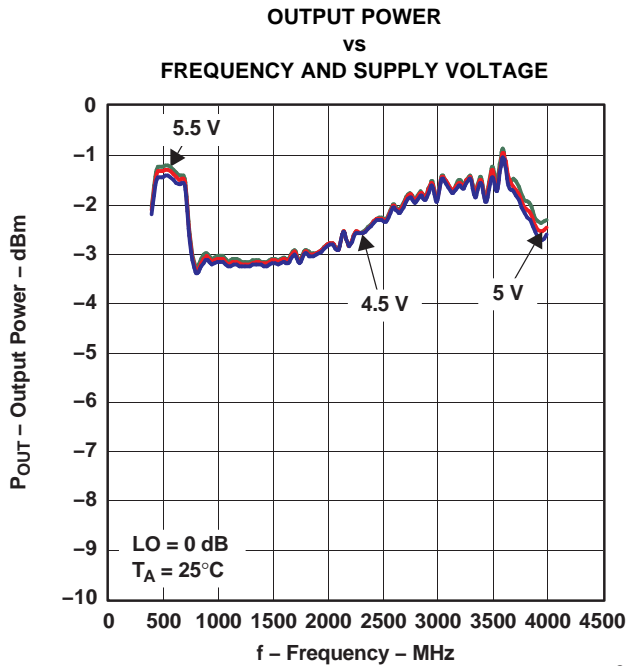

Figure 3.

G011

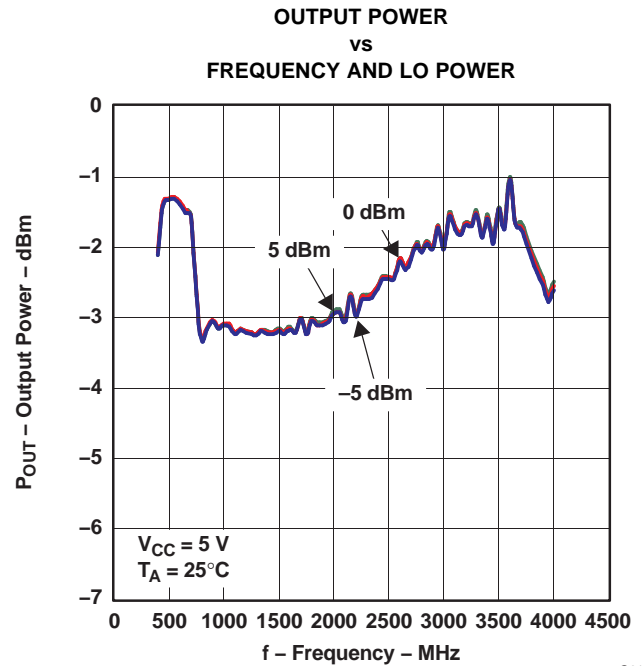

Figure 4.

G012

TYPICAL CHARACTERISTICS (continued)

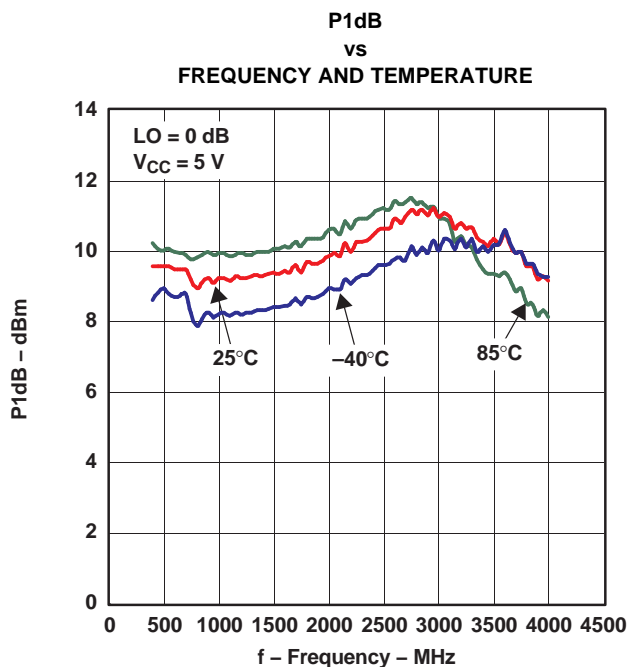

Figure 5.

G001

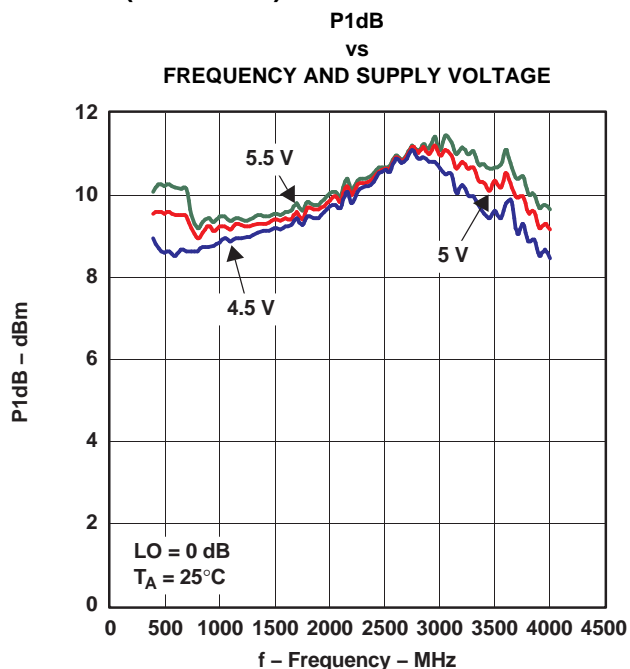

Figure 6.

G002

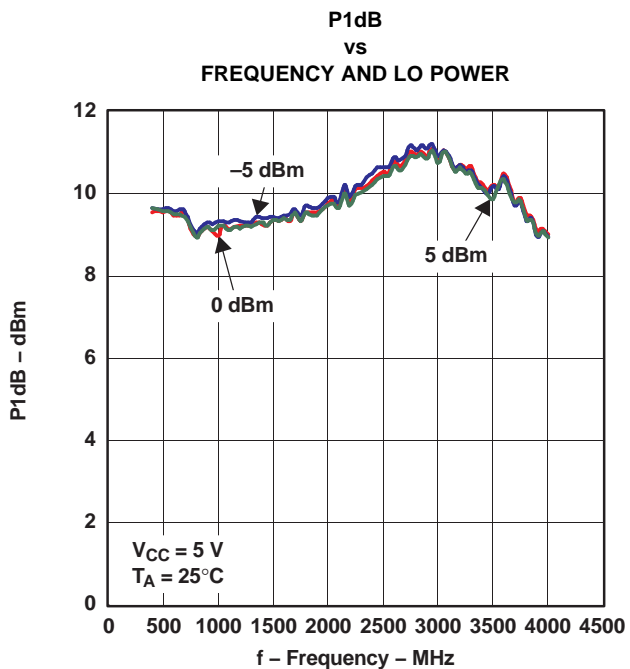

Figure 7.

G003

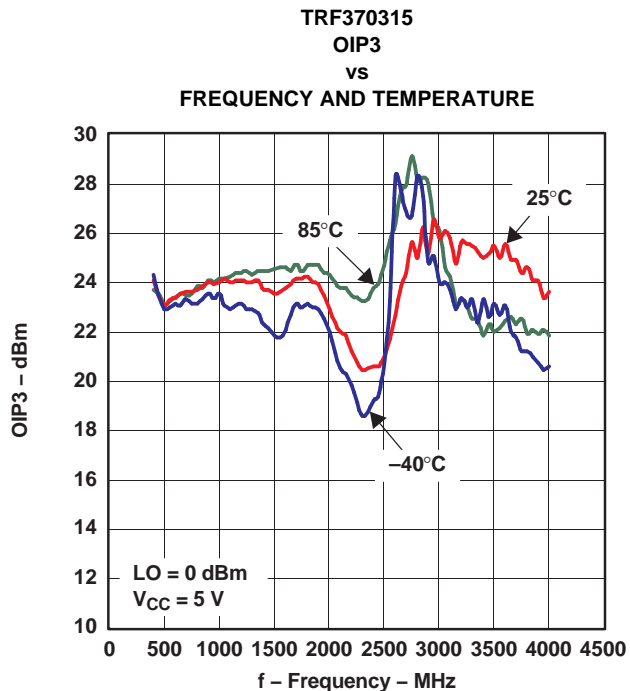

Figure 8.

G014

TYPICAL CHARACTERISTICS (continued)

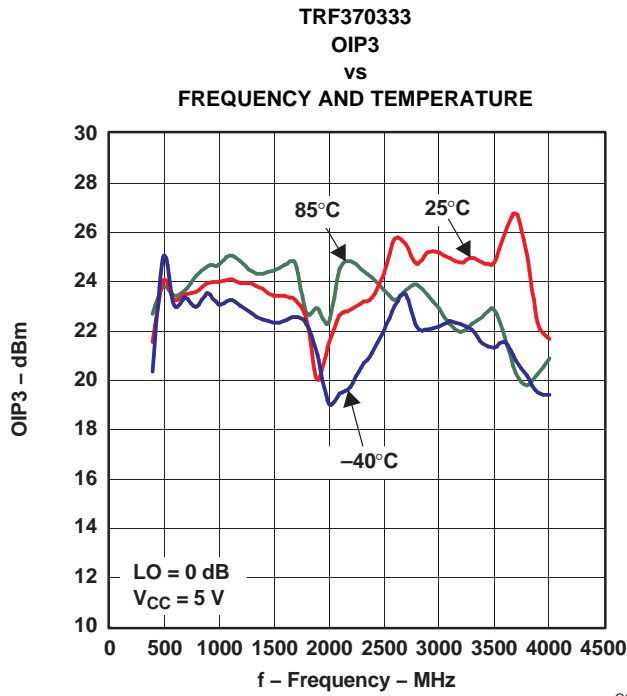

Figure 9.

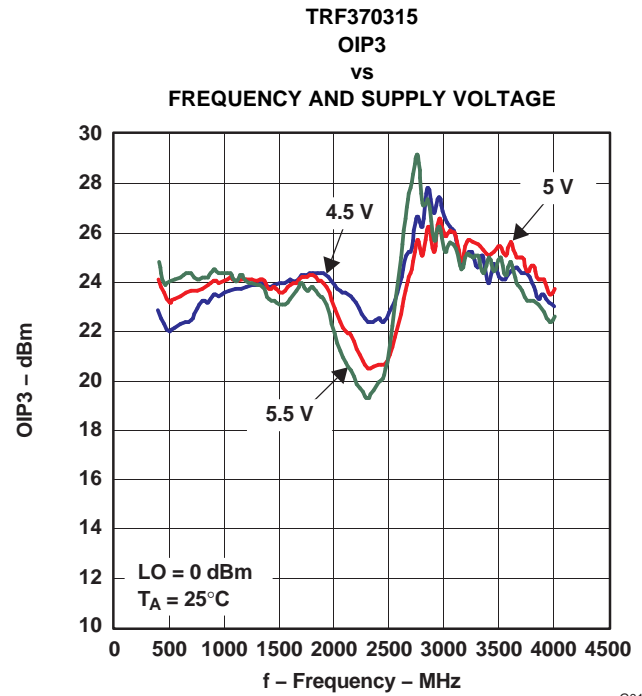

Figure 10.

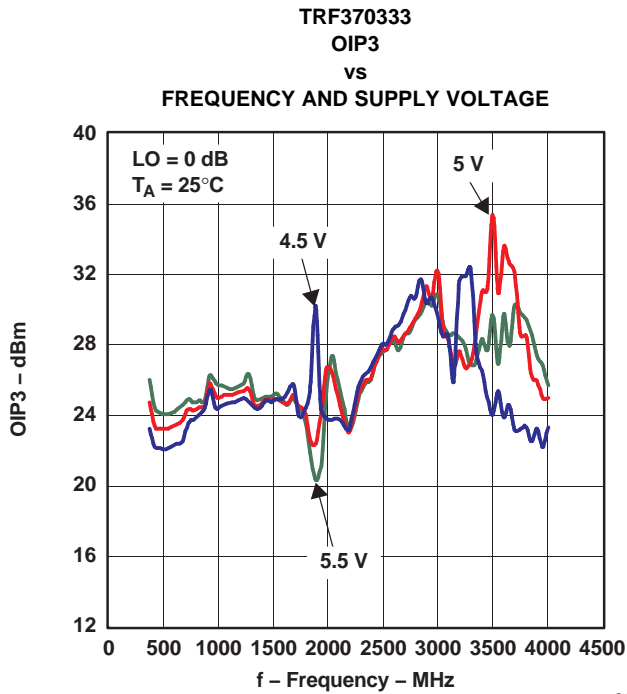

Figure 11.

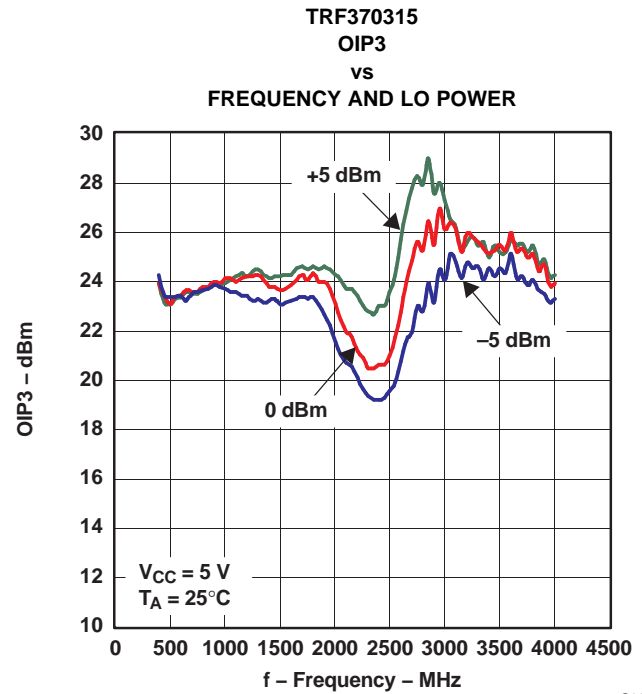

Figure 12.

TYPICAL CHARACTERISTICS (continued)

TRF370333
OIP3

vs
FREQUENCY AND LO POWER

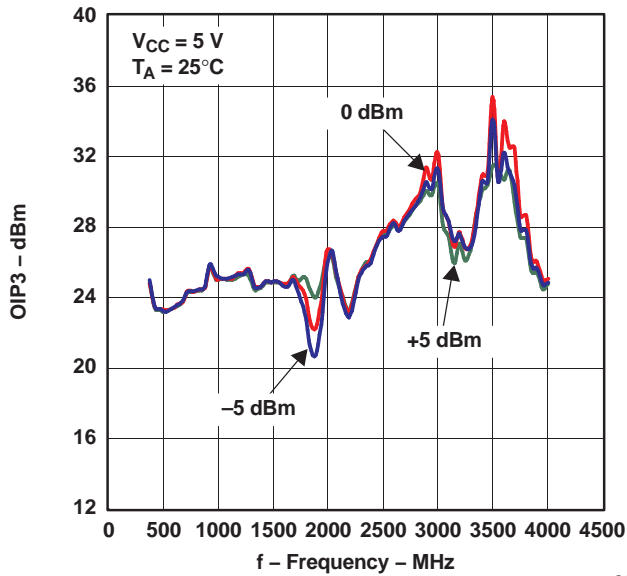

Figure 13.

G029

UNADJUSTED SIDEBAND SUPPRESSION
vs
FREQUENCY AND TEMPERATURE

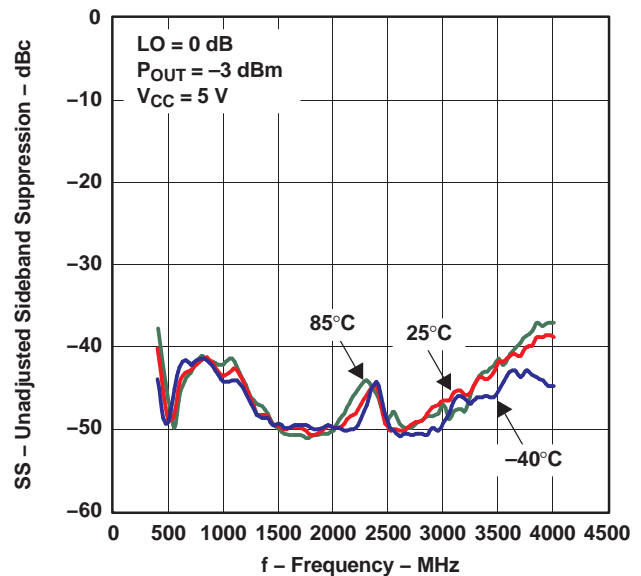

Figure 14.

G007

UNADJUSTED SIDEBAND SUPPRESSION
vs
FREQUENCY AND SUPPLY VOLTAGE

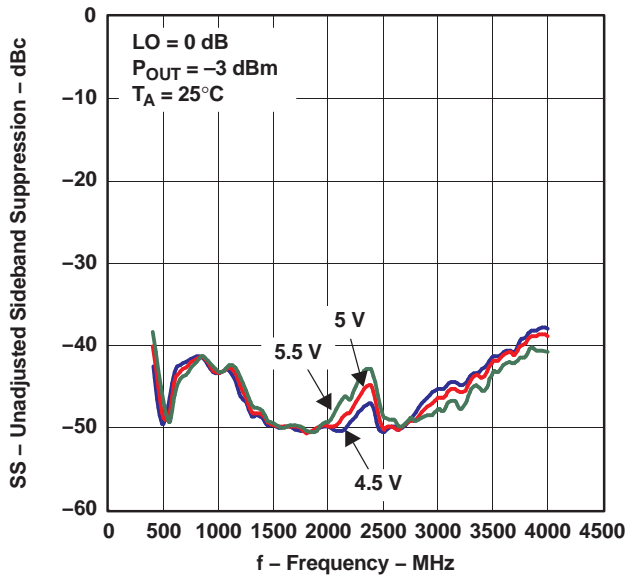

Figure 15.

G008

UNADJUSTED SIDEBAND SUPPRESSION
vs
FREQUENCY AND LO POWER

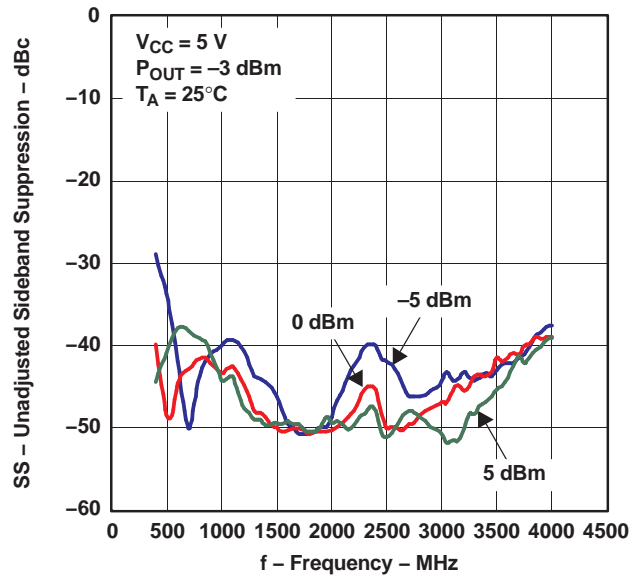

Figure 16.

G009

TYPICAL CHARACTERISTICS (continued)

ADJUSTED SIDEBAND SUPPRESSION
vs
FREQUENCY AND TEMPERATURE

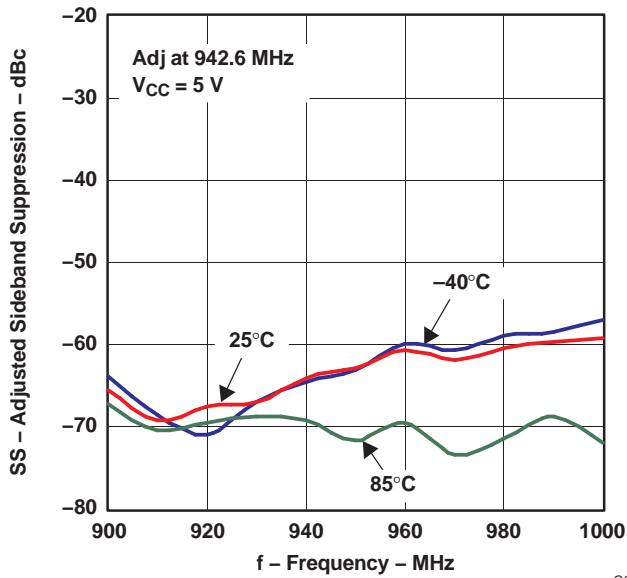

Figure 17.

G016

ADJUSTED SIDEBAND SUPPRESSION
vs
FREQUENCY AND TEMPERATURE

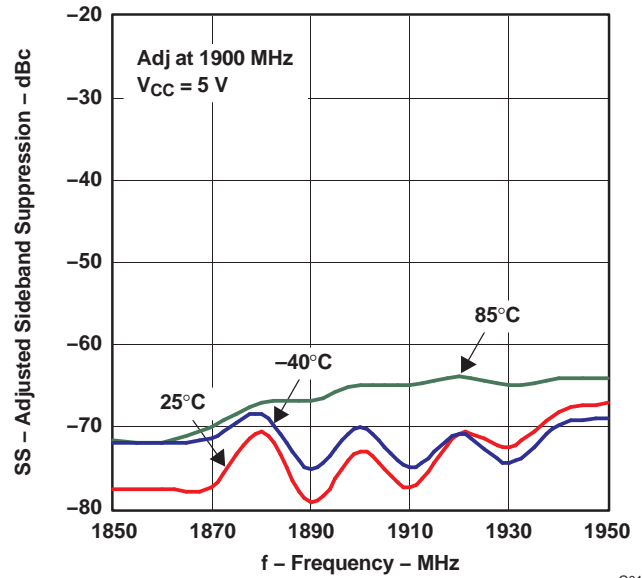

Figure 18.

G017

ADJUSTED SIDEBAND SUPPRESSION
vs
FREQUENCY AND TEMPERATURE

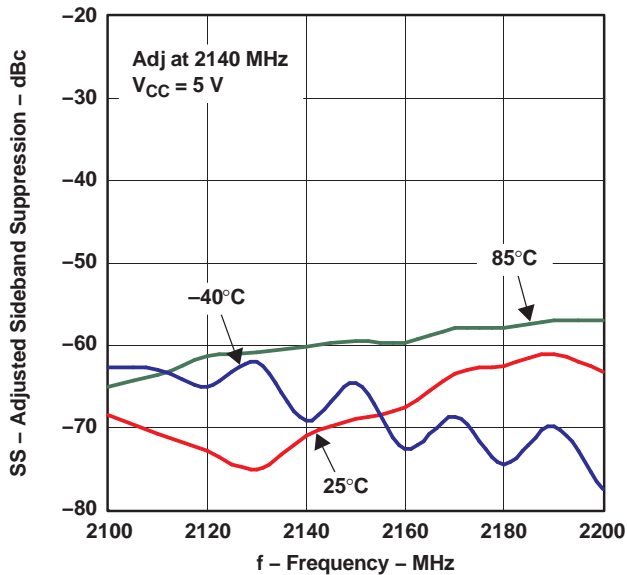

Figure 19.

G018

NOISE AT 13-MHz OFFSET (dBm/Hz)
vs
FREQUENCY AND SUPPLY VOLTAGE

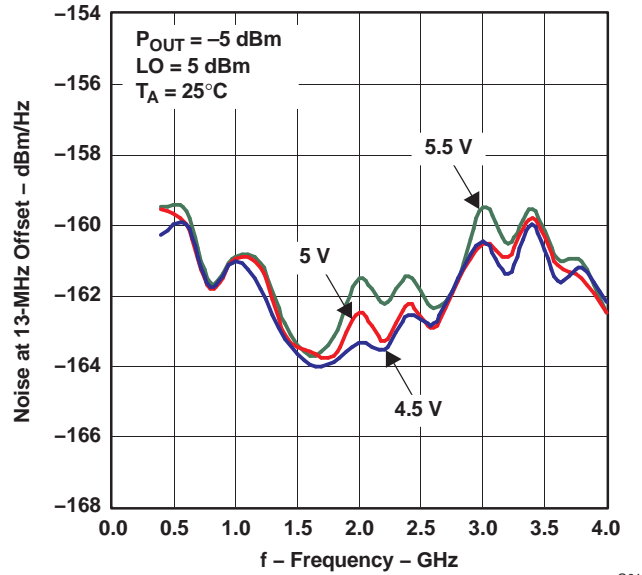

Figure 20.

G019

TYPICAL CHARACTERISTICS (continued)

NOISE AT 13-MHz OFFSET (dBm/Hz)
vs
FREQUENCY AND TEMPERATURE

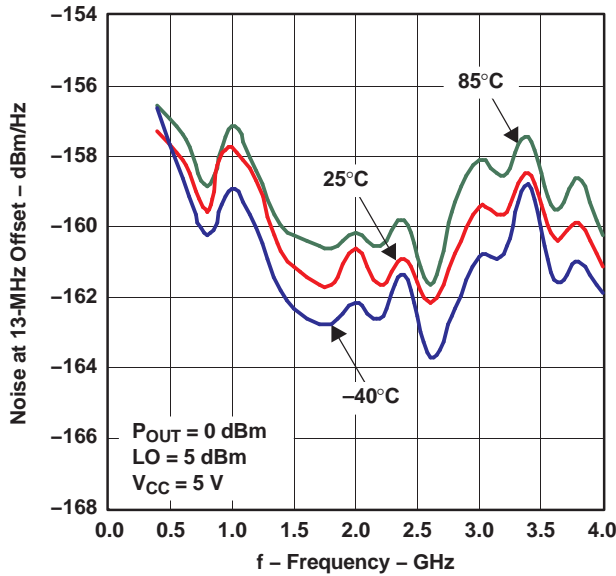

Figure 21.

G020

NOISE AT 13-MHz OFFSET (dBm/Hz)
vs
FREQUENCY AND TEMPERATURE

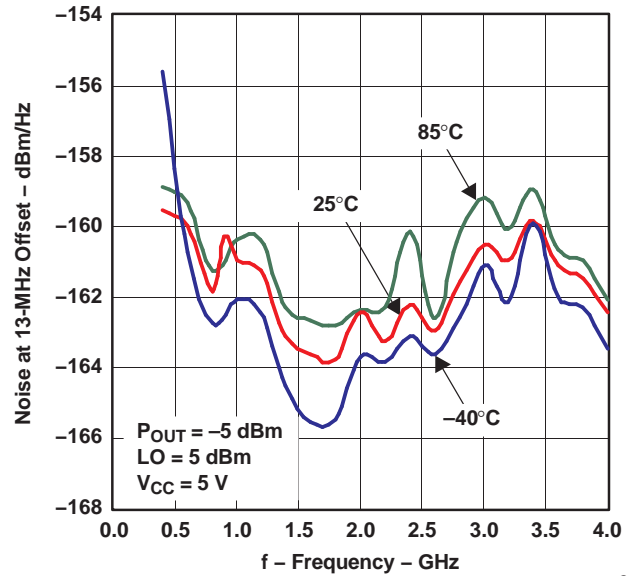

Figure 22.

G021

NOISE AT 13-MHz OFFSET (dBm/Hz)
vs
FREQUENCY AND TEMPERATURE

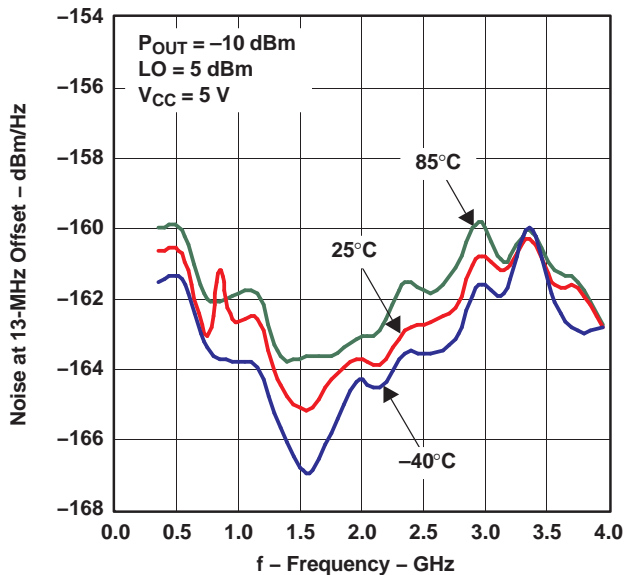

Figure 23.

G022

UNADJUSTED CARRIER FEEDTHROUGH
vs
FREQUENCY AND SUPPLY VOLTAGE

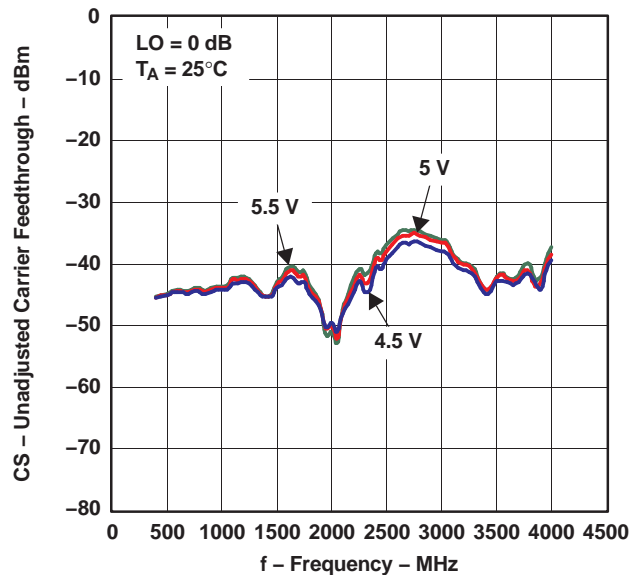

Figure 24.

G025

TYPICAL CHARACTERISTICS (continued)
UNADJUSTED CARRIER FEEDTHROUGH
vs
FREQUENCY AND TEMPERATURE

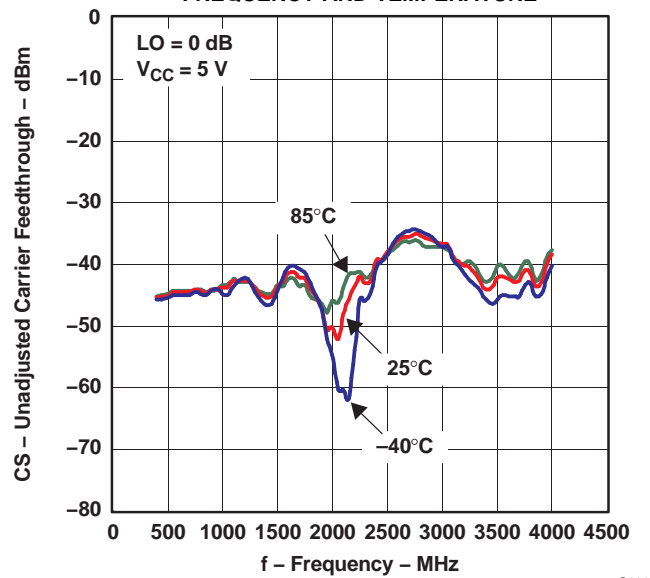

Figure 25.

APPLICATION INFORMATION AND EVALUATION BOARD

Basic Connections

- See [Figure 26](#) for proper connection of the TRF3703315 and TRF370333 modulator.
- Connect a single power supply (4.5 V–5.5 V) to pins 18 and 24. These pins should be decoupled as shown on pins 4, 5, 6, and 7.
- Connect pins 2, 5, 8, 11, 12, 14, 17, 19, 20, and 23 to GND.
- Connect a single-ended LO source of desired frequency to LOP (amplitude between –5 dBm and 12 dBm). This should be ac-coupled through a 100-pF capacitor.
- Terminate the ac-coupled LON with 50 Ω to GND.
- Connect a baseband signal to pins 21 = I, 22 = \bar{I} , 10 = Q, and 9 = \bar{Q} .
- The differential baseband inputs should be set to the proper level, 3.3 V for the TRF370333 or 1.5 V for the TRF370315.
- RF_OUT, pin 16, can be fed to a spectrum analyzer set to the desired frequency, LO \pm baseband signal. This pin should also be ac-coupled through a 100-pF capacitor.
- All NC pins can be left floating.

ESD Sensitivity

RF devices may be extremely sensitive to electrostatic discharge (ESD). To prevent damage from ESD, devices should be stored and handled in a way that prevents the build-up of electrostatic voltages that exceed the rated level. Rated ESD levels should also not be exceeded while the device is installed on a printed circuit board (PCB). Follow these guidelines for optimal ESD protection:

- Low ESD performance is not uncommon in RF ICs; see the [Absolute Maximum Ratings](#) table. Therefore, customers' ESD precautions should be consistent with these ratings.
- The device should be robust once assembled onto the PCB **unless** external inputs (connectors, etc.) directly connect the device pins to off-board circuits.

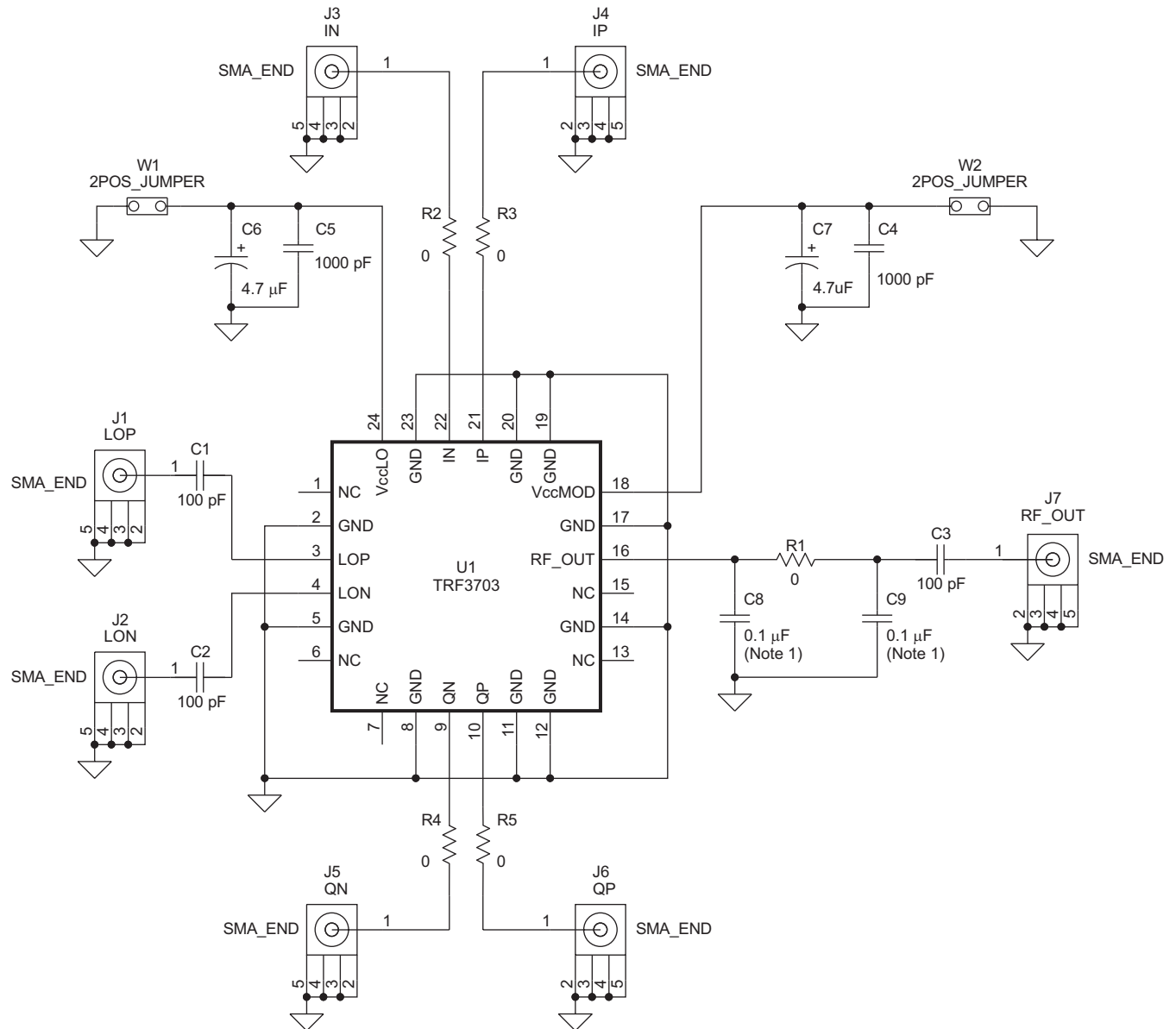

(1) Do not install.

S0214-01

Figure 26. TRF3703 EVM Schematic

Figure 27 shows the top view of the TRF3703 EVM board.

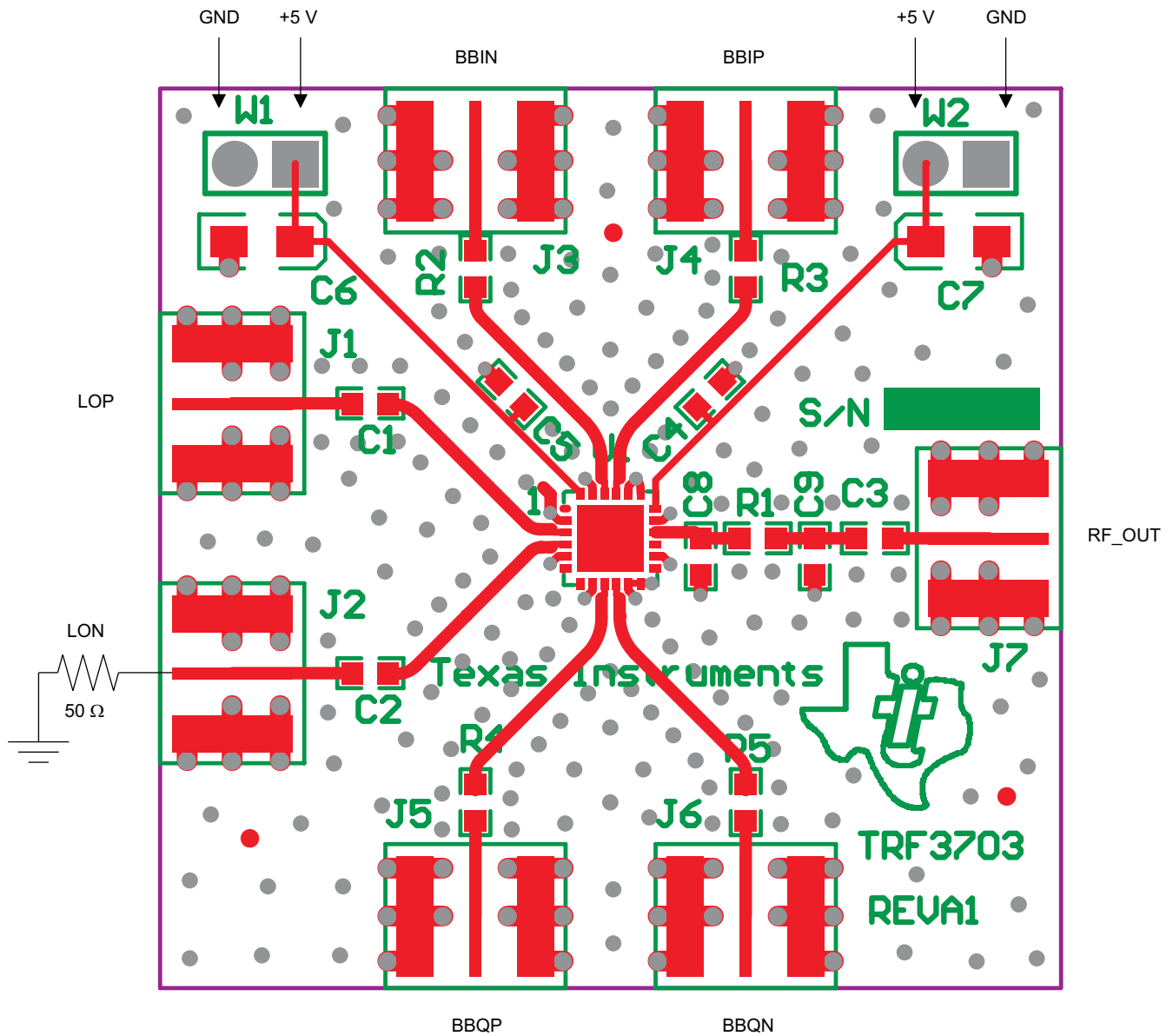

Figure 27. TRF3703 EVM Board Layout

Table 1. Bill of Materials for TRF3703 EVM

Value	Footprint	QTY	Part Number	Vendor	Digi-Key Number	REF DES	Not Installed
Tantalum 4.7- μ F, 10-V, 10% capacitor	3216	2	T491A475K010AS	KEMET	399-1561-1-ND	C6, C7	
1000-pF, 50-V, 5% capacitor	603	2	ECJ-1VC1H102J	Panasonic	PCC2151CT-ND	C4, C5	
100-pF, 50-V, 5% capacitor	603	3	ECJ-1VC1H101J	Panasonic	PCC101ACVCT-ND	C1, C2, C3	
Capacitor	603	0					C8, C9
0- Ω resistor, 1/10-W, 5%	603	5	ERJ-3GEY0R00V	Panasonic	P0.0GCT-ND	R1, R2, R3, R4, R5	

Table 1. Bill of Materials for TRF3703 EVM (continued)

Value	Footprint	QTY	Part Number	Vendor	Digi-Key Number	REF DES	Not Installed
TRF3703	24-QFN-PP-4X4MM	1		TI		U1	
SMA connectors	SMA_END_SMALL	6	16F3627	Newark	142-0711-821	J1, J2, J3, J4, J5, J6, J7	
2POS_HEADER	2POS_JUMP	2	HTSW-150-07-L-S	SAMTEC	N/A	W1, W2	

GSM Applications

The TRF370315 and TRF370333 are suited for GSM applications because of the high linearity and low noise level over the entire recommended operating range. These devices also have excellent EVM performance, which makes them ideal for the stringent GSM/EDGE applications.

WCDMA Applications

The TRF370315 and TRF370333 are also optimized for WCDMA applications where both adjacent-channel power ratio (ACPR) and noise density are critically important. Using Texas instruments’ DAC568X series of high-performance digital-to-analog converters as depicted in [Figure 28](#), excellent ACPR levels were measured with one-, two-, and four-WCDMA carriers. See *Electrical Characteristics*, $f_{LO} = 2140$ MHz for exact ACPR values.

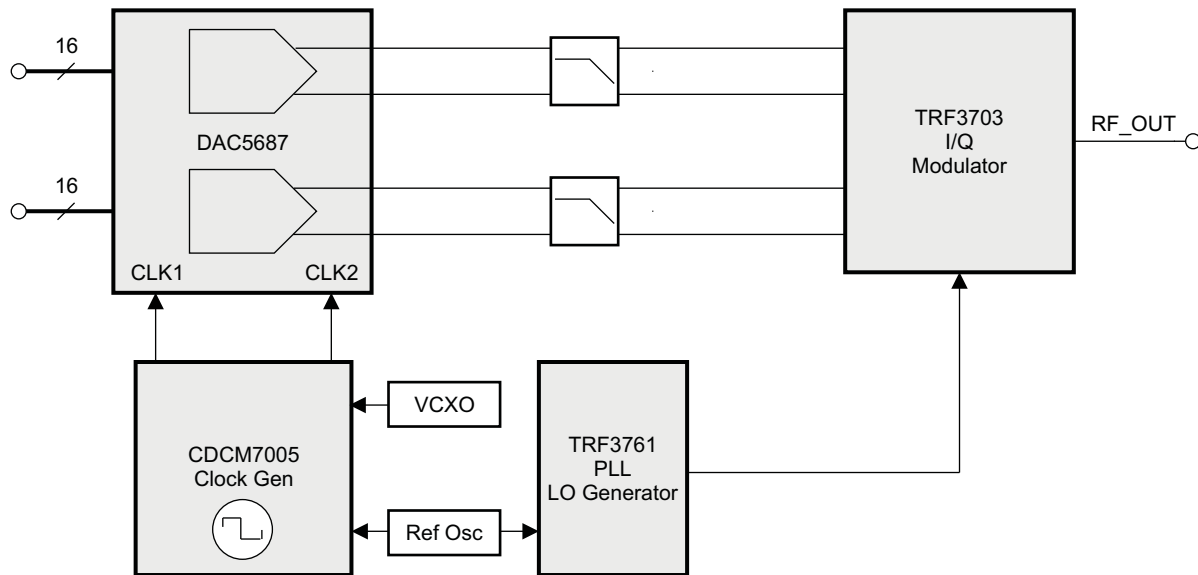

B0176-01

Figure 28. Typical Transmit Setup Block Diagram

DEFINITION OF SPECIFICATIONS

Unadjusted Carrier Feedthrough

This specification measures the amount by which the local oscillator component is attenuated in the output spectrum of the modulator relative to the carrier. This further assumes that the baseband inputs delivered to the pins of the TRF370315 and TRF370333 are perfectly matched to have the same dc offset (VCM). This includes all four baseband inputs: I, \bar{I} , Q, and \bar{Q} . This is measured in dBm.

Adjusted (Optimized) Carrier Feedthrough

This differs from the unadjusted suppression number in that the baseband input dc offsets are iteratively adjusted around their theoretical value of VCM to yield the maximum suppression of the LO component in the output spectrum. This is measured in dBm.

Unadjusted Sideband Suppression

This specification measures the amount by which the unwanted sideband of the input signal is attenuated in the output of the modulator, relative to the wanted sideband. This further assumes that the baseband inputs delivered to the modulator input pins are perfectly matched in amplitude and are exactly 90° out of phase. This is measured in dBc.

Adjusted (Optimized) Sideband Suppression

This differs from the unadjusted sideband suppression in that the baseband inputs are iteratively adjusted around their theoretical values to maximize the amount of sideband suppression. This is measured in dBc.

Suppressions Overtemperature

This specification assumes that the user has gone through the optimization process for the suppression in question, and set the optimal settings for the I, Q inputs. This specification then measures the suppression when temperature conditions change after the initial calibration is done.

Figure 29 shows a simulated output and illustrates the respective definitions of various terms used in this data sheet. The graph assumes a baseband input of 50 kHz.

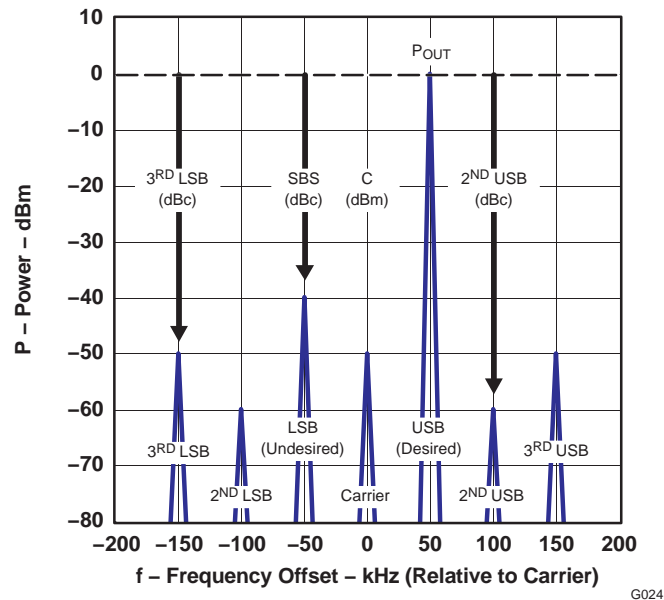

Figure 29. Graphical Illustration of Common Terms

REVISION HISTORY

NOTE: Page numbers for previous revisions may differ from page numbers in the current version.

Changes from Revision I (July, 2010) to Revision J	Page
• Changed <i>voltage gain</i> specifications for $f_{LO} = 350$ -MHz performance data	4
• Updated <i>voltage gain</i> specifications for $f_{LO} = 400$ -MHz performance data	4
• Revised <i>voltage gain</i> specifications for $f_{LO} = 900$ -MHz performance data	5
• Changed <i>voltage gain</i> specifications for $f_{LO} = 1800$ -MHz performance data	5
• Revised <i>voltage gain</i> specifications for $f_{LO} = 1960$ -MHz performance data	6
• Updated <i>voltage gain</i> specifications for $f_{LO} = 2140$ -MHz performance data	6
• Revised <i>voltage gain</i> specifications for $f_{LO} = 2500$ -MHz performance data	7
• Changed <i>voltage gain</i> specifications for $f_{LO} = 3600$ -MHz performance data	7
• Updated <i>voltage gain</i> specifications for $f_{LO} = 4000$ -MHz performance data	7
• Replaced Figure 1	8

Changes from Revision H (January, 2010) to Revision I	Page
• Changed document title to reflect 0.35-GHz minimum operating level	1
• Updated <i>Description</i> section to reflect 350-MHz minimum operation	1
• Changed LO frequency range minimum specification from 0.4 GHz to 0.35 GHz	4
• Added <i>Electrical Characteristics</i> table for $f_{LO} = 350$ -MHz performance data	4

PACKAGING INFORMATION

Orderable Device	Status (1)	Package Type	Package Drawing	Pins	Package Qty	Eco Plan (2)	Lead/Ball Finish (6)	MSL Peak Temp (3)	Op Temp (°C)	Device Marking (4/5)	Samples
TRF370315IRGER	ACTIVE	VQFN	RGE	24	3000	Green (RoHS & no Sb/Br)	CU NIPDAU	Level-2-260C-1 YEAR	-40 to 85	TRF37 0315	Samples
TRF370315IRGET	ACTIVE	VQFN	RGE	24	250	Green (RoHS & no Sb/Br)	CU NIPDAU	Level-2-260C-1 YEAR	-40 to 85	TRF37 0315	Samples
TRF370333IRGER	ACTIVE	VQFN	RGE	24	3000	Green (RoHS & no Sb/Br)	CU NIPDAU	Level-2-260C-1 YEAR	-40 to 85	TRF37 0333	Samples
TRF370333IRGET	ACTIVE	VQFN	RGE	24	250	Green (RoHS & no Sb/Br)	CU NIPDAU	Level-2-260C-1 YEAR	-40 to 85	TRF37 0333	Samples
TRF370333IRGETG4	ACTIVE	VQFN	RGE	24	250	Green (RoHS & no Sb/Br)	CU NIPDAU	Level-2-260C-1 YEAR	-40 to 85	TRF37 0333	Samples

(1) The marketing status values are defined as follows:

ACTIVE: Product device recommended for new designs.

LIFEBUY: TI has announced that the device will be discontinued, and a lifetime-buy period is in effect.

NRND: Not recommended for new designs. Device is in production to support existing customers, but TI does not recommend using this part in a new design.

PREVIEW: Device has been announced but is not in production. Samples may or may not be available.

OBSOLETE: TI has discontinued the production of the device.

(2) Eco Plan - The planned eco-friendly classification: Pb-Free (RoHS), Pb-Free (RoHS Exempt), or Green (RoHS & no Sb/Br) - please check <http://www.ti.com/productcontent> for the latest availability information and additional product content details.

TBD: The Pb-Free/Green conversion plan has not been defined.

Pb-Free (RoHS): TI's terms "Lead-Free" or "Pb-Free" mean semiconductor products that are compatible with the current RoHS requirements for all 6 substances, including the requirement that lead not exceed 0.1% by weight in homogeneous materials. Where designed to be soldered at high temperatures, TI Pb-Free products are suitable for use in specified lead-free processes.

Pb-Free (RoHS Exempt): This component has a RoHS exemption for either 1) lead-based flip-chip solder bumps used between the die and package, or 2) lead-based die adhesive used between the die and leadframe. The component is otherwise considered Pb-Free (RoHS compatible) as defined above.

Green (RoHS & no Sb/Br): TI defines "Green" to mean Pb-Free (RoHS compatible), and free of Bromine (Br) and Antimony (Sb) based flame retardants (Br or Sb do not exceed 0.1% by weight in homogeneous material)

(3) MSL, Peak Temp. - The Moisture Sensitivity Level rating according to the JEDEC industry standard classifications, and peak solder temperature.

(4) There may be additional marking, which relates to the logo, the lot trace code information, or the environmental category on the device.

(5) Multiple Device Markings will be inside parentheses. Only one Device Marking contained in parentheses and separated by a "~" will appear on a device. If a line is indented then it is a continuation of the previous line and the two combined represent the entire Device Marking for that device.

⁽⁶⁾ Lead/Ball Finish - Orderable Devices may have multiple material finish options. Finish options are separated by a vertical ruled line. Lead/Ball Finish values may wrap to two lines if the finish value exceeds the maximum column width.

Important Information and Disclaimer:The information provided on this page represents TI's knowledge and belief as of the date that it is provided. TI bases its knowledge and belief on information provided by third parties, and makes no representation or warranty as to the accuracy of such information. Efforts are underway to better integrate information from third parties. TI has taken and continues to take reasonable steps to provide representative and accurate information but may not have conducted destructive testing or chemical analysis on incoming materials and chemicals. TI and TI suppliers consider certain information to be proprietary, and thus CAS numbers and other limited information may not be available for release.

In no event shall TI's liability arising out of such information exceed the total purchase price of the TI part(s) at issue in this document sold by TI to Customer on an annual basis.

TAPE AND REEL INFORMATION

QUADRANT ASSIGNMENTS FOR PIN 1 ORIENTATION IN TAPE

*All dimensions are nominal

Device	Package Type	Package Drawing	Pins	SPQ	Reel Diameter (mm)	Reel Width W1 (mm)	A0 (mm)	B0 (mm)	K0 (mm)	P1 (mm)	W (mm)	Pin1 Quadrant
TRF370315IRGER	VQFN	RGE	24	3000	330.0	12.4	4.3	4.3	1.5	8.0	12.0	Q1
TRF370315IRGET	VQFN	RGE	24	250	180.0	12.4	4.3	4.3	1.5	8.0	12.0	Q1
TRF370333IRGER	VQFN	RGE	24	3000	330.0	12.4	4.3	4.3	1.5	8.0	12.0	Q2
TRF370333IRGET	VQFN	RGE	24	250	180.0	12.4	4.3	4.3	1.5	8.0	12.0	Q2

TAPE AND REEL BOX DIMENSIONS

*All dimensions are nominal

Device	Package Type	Package Drawing	Pins	SPQ	Length (mm)	Width (mm)	Height (mm)
TRF370315IRGER	VQFN	RGE	24	3000	338.1	338.1	20.6
TRF370315IRGET	VQFN	RGE	24	250	210.0	185.0	35.0
TRF370333IRGER	VQFN	RGE	24	3000	338.1	338.1	20.6
TRF370333IRGET	VQFN	RGE	24	250	210.0	185.0	35.0

RGE (S-PVQFN-N24)

PLASTIC QUAD FLATPACK NO-LEAD

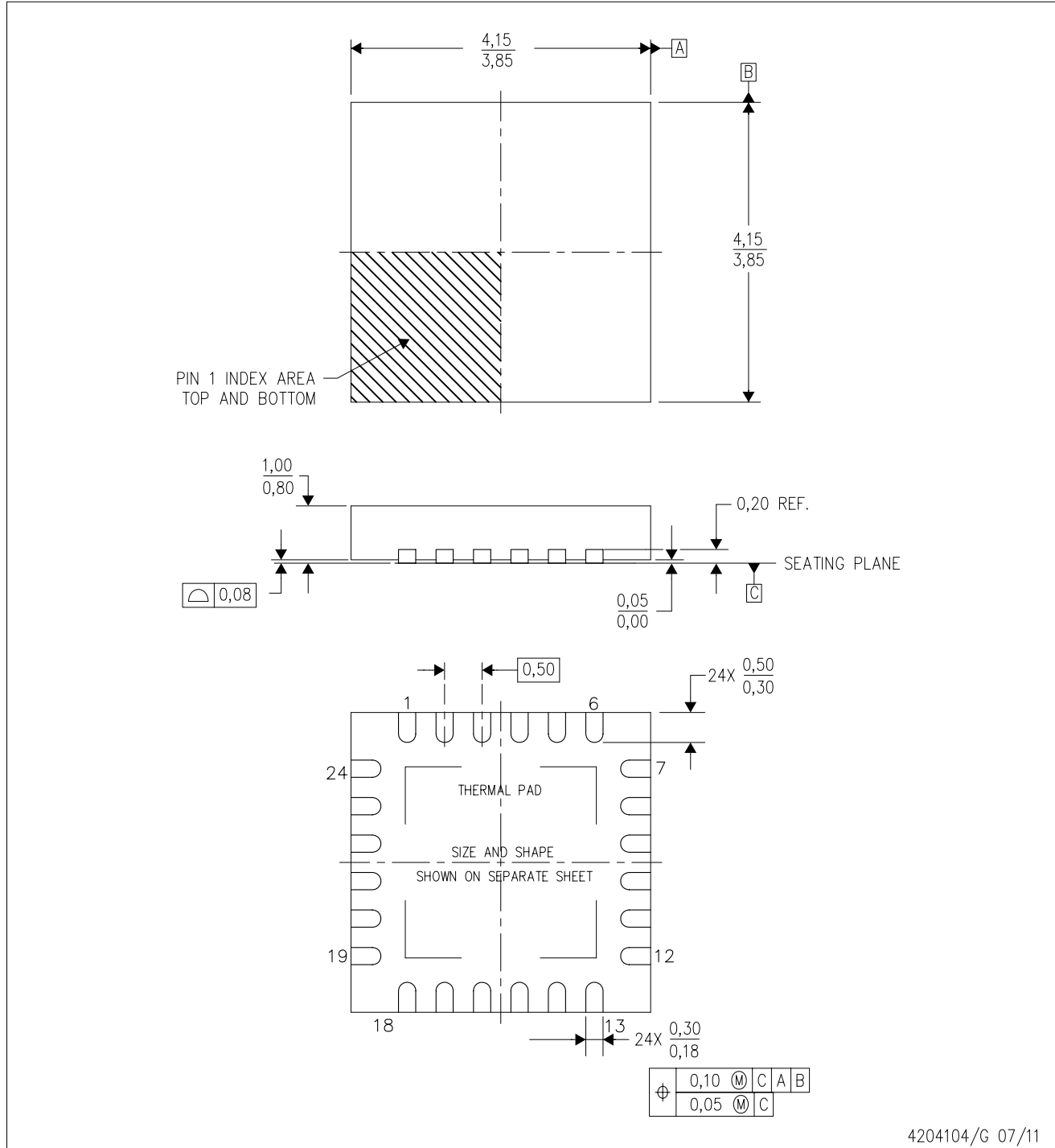

4204104/G 07/11

- NOTES:
- All linear dimensions are in millimeters. Dimensioning and tolerancing per ASME Y14.5M-1994.
 - This drawing is subject to change without notice.
 - Quad Flatpack, No-Leads (QFN) package configuration.
 - The package thermal pad must be soldered to the board for thermal and mechanical performance.
 - See the additional figure in the Product Data Sheet for details regarding the exposed thermal pad features and dimensions.
 - Falls within JEDEC MO-220.

THERMAL PAD MECHANICAL DATA

RGE (S-PVQFN-N24)

PLASTIC QUAD FLATPACK NO-LEAD

THERMAL INFORMATION

This package incorporates an exposed thermal pad that is designed to be attached directly to an external heatsink. The thermal pad must be soldered directly to the printed circuit board (PCB). After soldering, the PCB can be used as a heatsink. In addition, through the use of thermal vias, the thermal pad can be attached directly to the appropriate copper plane shown in the electrical schematic for the device, or alternatively, can be attached to a special heatsink structure designed into the PCB. This design optimizes the heat transfer from the integrated circuit (IC).

For information on the Quad Flatpack No-Lead (QFN) package and its advantages, refer to Application Report, QFN/SON PCB Attachment, Texas Instruments Literature No. SLUA271. This document is available at www.ti.com.

The exposed thermal pad dimensions for this package are shown in the following illustration.

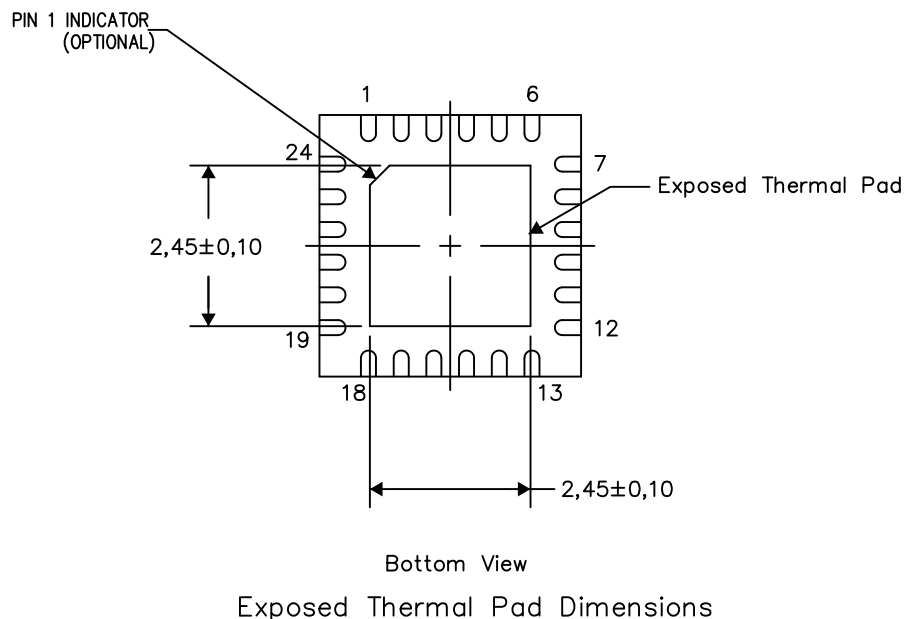

4206344-3/AK 08/15

NOTES: A. All linear dimensions are in millimeters

RGE (S-PVQFN-N24)

PLASTIC QUAD FLATPACK NO-LEAD

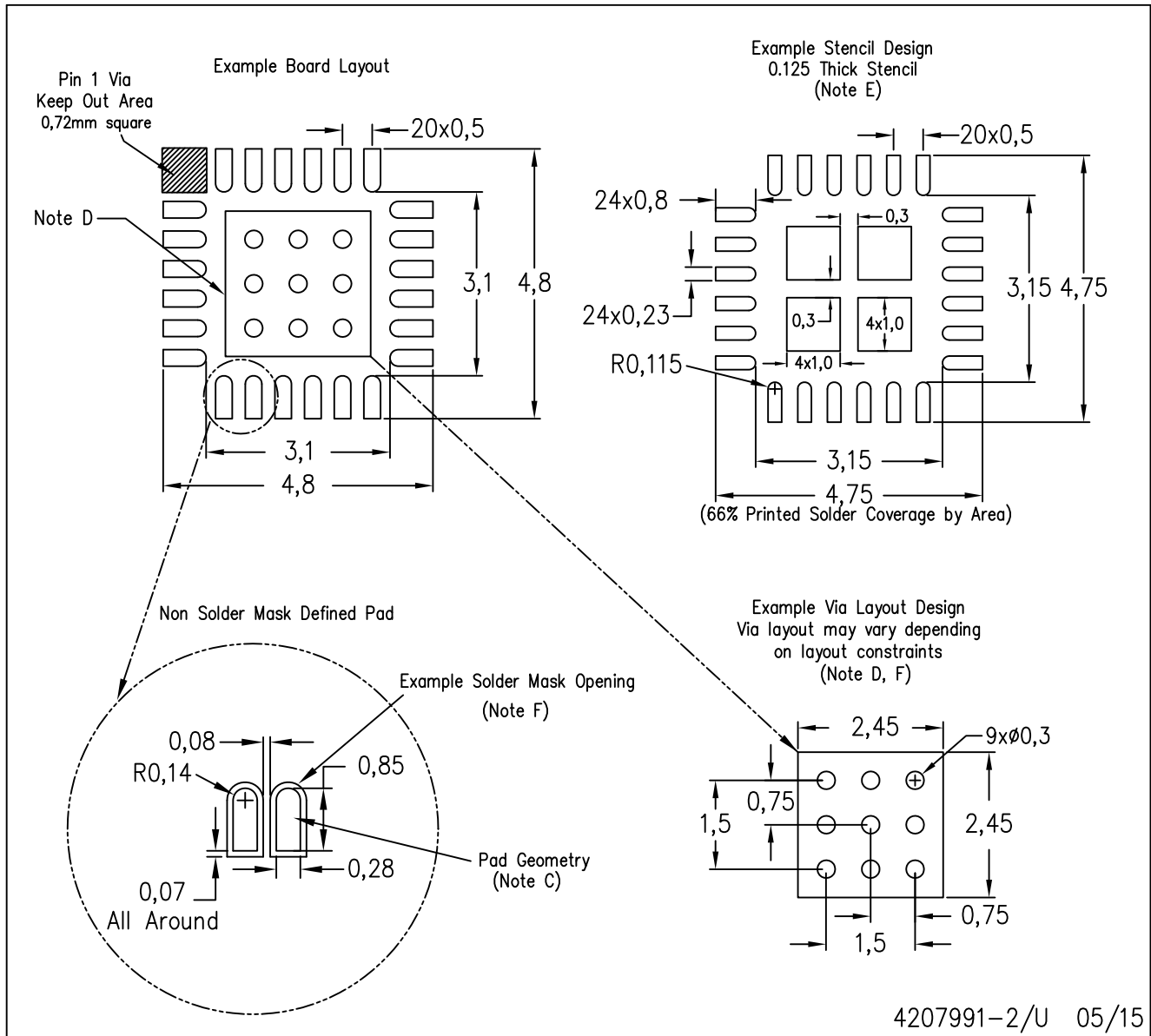

- NOTES:
- All linear dimensions are in millimeters.
 - This drawing is subject to change without notice.
 - Publication IPC-7351 is recommended for alternate designs.
 - This package is designed to be soldered to a thermal pad on the board. Refer to Application Note, Quad Flat-Pack Packages, Texas Instruments Literature No. SLUA271, and also the Product Data Sheets for specific thermal information, via requirements, and recommended board layout. These documents are available at www.ti.com <<http://www.ti.com>>.
 - Laser cutting apertures with trapezoidal walls and also rounding corners will offer better paste release. Customers should contact their board assembly site for stencil design recommendations. Refer to IPC 7525 for stencil design considerations.
 - Customers should contact their board fabrication site for recommended solder mask tolerances and via tenting recommendations for vias placed in the thermal pad.

IMPORTANT NOTICE

Texas Instruments Incorporated and its subsidiaries (TI) reserve the right to make corrections, enhancements, improvements and other changes to its semiconductor products and services per JESD46, latest issue, and to discontinue any product or service per JESD48, latest issue. Buyers should obtain the latest relevant information before placing orders and should verify that such information is current and complete. All semiconductor products (also referred to herein as "components") are sold subject to TI's terms and conditions of sale supplied at the time of order acknowledgment.

TI warrants performance of its components to the specifications applicable at the time of sale, in accordance with the warranty in TI's terms and conditions of sale of semiconductor products. Testing and other quality control techniques are used to the extent TI deems necessary to support this warranty. Except where mandated by applicable law, testing of all parameters of each component is not necessarily performed.

TI assumes no liability for applications assistance or the design of Buyers' products. Buyers are responsible for their products and applications using TI components. To minimize the risks associated with Buyers' products and applications, Buyers should provide adequate design and operating safeguards.

TI does not warrant or represent that any license, either express or implied, is granted under any patent right, copyright, mask work right, or other intellectual property right relating to any combination, machine, or process in which TI components or services are used. Information published by TI regarding third-party products or services does not constitute a license to use such products or services or a warranty or endorsement thereof. Use of such information may require a license from a third party under the patents or other intellectual property of the third party, or a license from TI under the patents or other intellectual property of TI.

Reproduction of significant portions of TI information in TI data books or data sheets is permissible only if reproduction is without alteration and is accompanied by all associated warranties, conditions, limitations, and notices. TI is not responsible or liable for such altered documentation. Information of third parties may be subject to additional restrictions.

Resale of TI components or services with statements different from or beyond the parameters stated by TI for that component or service voids all express and any implied warranties for the associated TI component or service and is an unfair and deceptive business practice. TI is not responsible or liable for any such statements.

Buyer acknowledges and agrees that it is solely responsible for compliance with all legal, regulatory and safety-related requirements concerning its products, and any use of TI components in its applications, notwithstanding any applications-related information or support that may be provided by TI. Buyer represents and agrees that it has all the necessary expertise to create and implement safeguards which anticipate dangerous consequences of failures, monitor failures and their consequences, lessen the likelihood of failures that might cause harm and take appropriate remedial actions. Buyer will fully indemnify TI and its representatives against any damages arising out of the use of any TI components in safety-critical applications.

In some cases, TI components may be promoted specifically to facilitate safety-related applications. With such components, TI's goal is to help enable customers to design and create their own end-product solutions that meet applicable functional safety standards and requirements. Nonetheless, such components are subject to these terms.

No TI components are authorized for use in FDA Class III (or similar life-critical medical equipment) unless authorized officers of the parties have executed a special agreement specifically governing such use.

Only those TI components which TI has specifically designated as military grade or "enhanced plastic" are designed and intended for use in military/aerospace applications or environments. Buyer acknowledges and agrees that any military or aerospace use of TI components which have **not** been so designated is solely at the Buyer's risk, and that Buyer is solely responsible for compliance with all legal and regulatory requirements in connection with such use.

TI has specifically designated certain components as meeting ISO/TS16949 requirements, mainly for automotive use. In any case of use of non-designated products, TI will not be responsible for any failure to meet ISO/TS16949.

Products

Audio	www.ti.com/audio
Amplifiers	amplifier.ti.com
Data Converters	dataconverter.ti.com
DLP® Products	www.dlp.com
DSP	dsp.ti.com
Clocks and Timers	www.ti.com/clocks
Interface	interface.ti.com
Logic	logic.ti.com
Power Mgmt	power.ti.com
Microcontrollers	microcontroller.ti.com
RFID	www.ti-rfid.com
OMAP Applications Processors	www.ti.com/omap
Wireless Connectivity	www.ti.com/wirelessconnectivity

Applications

Automotive and Transportation	www.ti.com/automotive
Communications and Telecom	www.ti.com/communications
Computers and Peripherals	www.ti.com/computers
Consumer Electronics	www.ti.com/consumer-apps
Energy and Lighting	www.ti.com/energy
Industrial	www.ti.com/industrial
Medical	www.ti.com/medical
Security	www.ti.com/security
Space, Avionics and Defense	www.ti.com/space-avionics-defense
Video and Imaging	www.ti.com/video

TI E2E Community

e2e.ti.com