

Single-channel high-side solid state relay

Features

Type	R _{DS(on)}	I _{OUT}	V _{CC}
VN920-B5H	18 mΩ	30 A	36 V

- CMOS compatible input
- Proportional load current sense
- Shorted load protection
- Under voltage and overvoltage shutdown
- Overvoltage clamp
- Thermal shutdown
- Current limitation
- Protection against loss of ground and loss of V_{CC}
- Very low standby power dissipation
- Reverse battery protected (see [Figure 19: Application schematic](#))

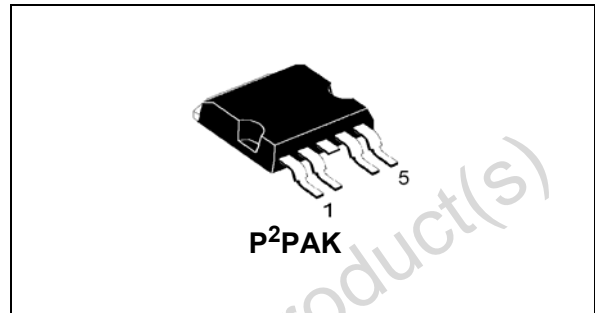

Description

The VN920-B5H is a monolithic device made by using STMicroelectronics VIPower™ M0-3 technology, intended for driving any kind of load with one side connected to ground. Active V_{CC} pin voltage clamp protects the device against low energy spikes (see ISO7637 transient compatibility able).

Active current limitation combined with thermal shutdown and automatic restart protect the device against overload. The device integrates an analog current sense output which delivers a current proportional to the load current. Device automatically turns off in case of ground pin disconnection.

Table 1. Device summary

Package	Order codes	
	Tube	Tape and reel
P ² PAK	VN920-B5H	VN920-B5H13TR

Contents

1	Block diagram and pin description	5
2	Electrical specifications	6
2.1	Absolute maximum ratings	6
2.2	Thermal data	7
2.3	Electrical characteristics	7
2.4	Electrical characteristics curves	14
3	Application information	16
3.1	GND protection network against reverse battery	16
3.1.1	Solution 1: resistor in the ground line (RGND only)	16
3.1.2	Solution 2: diode (DGND) in the ground line	17
3.2	Load dump protection	17
3.3	MCU I/Os protection	17
3.4	Maximum demagnetization energy	18
4	Package and PCB thermal data	19
4.1	P ² PAK thermal data	19
5	Package and packing information	22
5.1	ECOPACK [®] packages	22
5.1.1	P ² PAK mechanical data	22
5.2	P ² PAK packing information	23
6	Revision history	25

List of tables

Table 1.	Device summary	1
Table 2.	Suggested connections for unused and not connected pins	5
Table 3.	Absolute maximum ratings	6
Table 4.	Thermal data.	7
Table 5.	Power	7
Table 6.	Switching ($V_{CC}=13V$)	8
Table 7.	Logic inputs.	8
Table 8.	Current sense ($9 V \leq V_{CC} \leq 16 V$)	9
Table 9.	Protections	10
Table 10.	V_{CC} output diode.	10
Table 11.	Truth table.	11
Table 12.	Electrical transient requirements (part 1/3).	12
Table 13.	Electrical transient requirements (part 2/3).	12
Table 14.	Electrical transient requirements (part 3/3).	12
Table 15.	Thermal parameter	21
Table 16.	P ² PAK mechanical data	23
Table 17.	Document revision history	25

List of figures

Figure 1.	Block diagram	5
Figure 2.	Configuration diagram (top view)	5
Figure 3.	Current and voltage conventions	6
Figure 4.	I_{OUT}/I_{SENSE} versus I_{OUT}	10
Figure 5.	Switching characteristics (resistive load $R_L = 1.3 \Omega$)	11
Figure 6.	Waveforms	13
Figure 7.	Off-state output current	14
Figure 8.	High-level input current	14
Figure 9.	Input clamp voltage	14
Figure 10.	Input high-level voltage	14
Figure 11.	Input low-level voltage	14
Figure 12.	Input hysteresis voltage	14
Figure 13.	Overshoot shutdown	15
Figure 14.	ILIM vs Tcase	15
Figure 15.	Turn-on voltage slope	15
Figure 16.	Turn-off voltage slope	15
Figure 17.	On-state resistance vs T_{CASE}	15
Figure 18.	On-state resistance vs V_{CC}	15
Figure 19.	Application schematic	16
Figure 20.	Maximum turn-off current versus load inductance	18
Figure 21.	Demagnetization	18
Figure 22.	P ² PAK PC board	19
Figure 23.	Rthj-amb vs PCB copper area in open box free air condition	19
Figure 24.	Thermal impedance junction ambient single pulse	20
Figure 25.	Thermal fitting model of a quad channel HSD in P ² PAK	20
Figure 26.	P ² PAK package dimensions	22
Figure 27.	P ² PAK tube shipment (no suffix)	23
Figure 28.	P ² PAK tube shipment (no suffix)	24

1 Block diagram and pin description

Figure 1. Block diagram

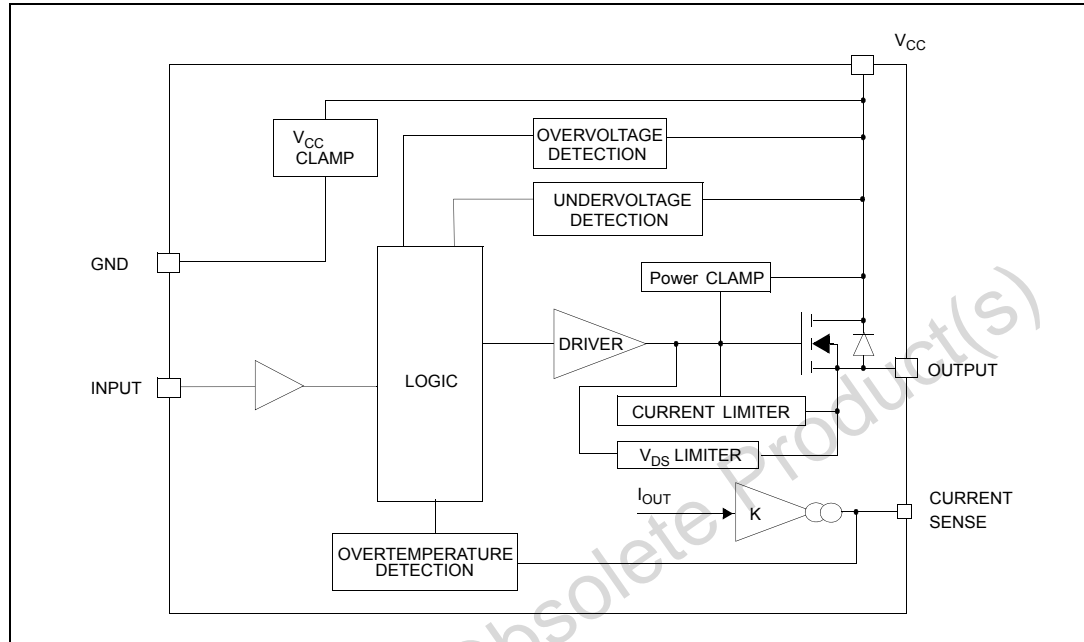

Figure 2. Configuration diagram (top view)

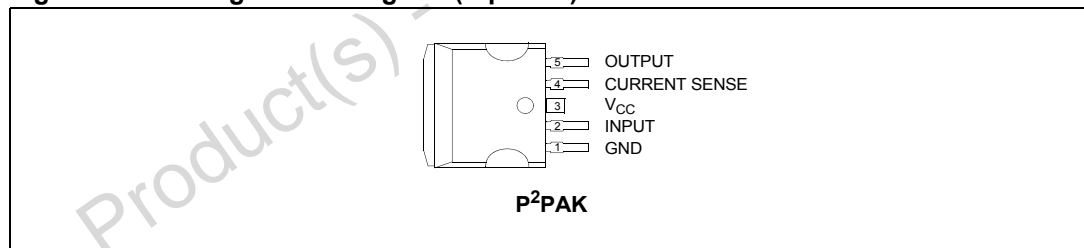
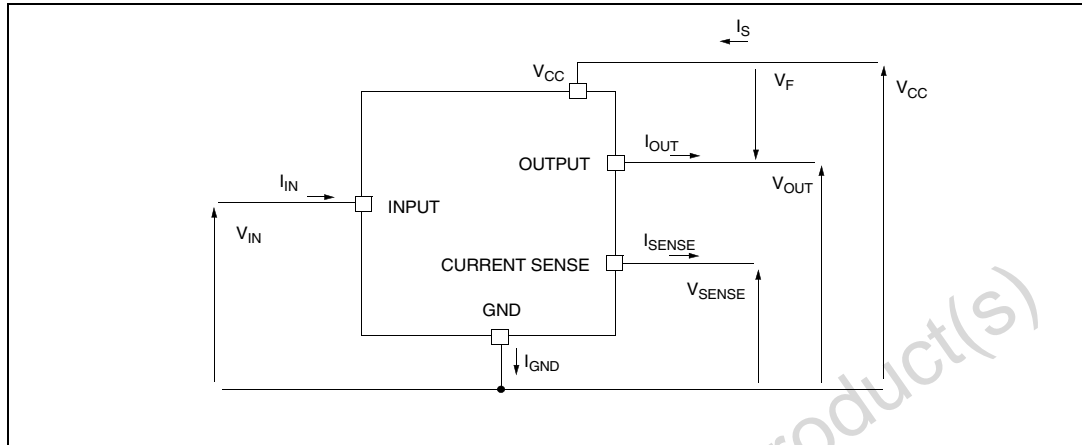

Table 2. Suggested connections for unused and not connected pins

Connection / pin	Current Sense	N.C.	Output	Input
Floating		X	X	X
To ground	Through 1 KΩ resistor	X		Through 10 KΩ resistor

2 Electrical specifications

Figure 3. Current and voltage conventions



2.1 Absolute maximum ratings

Stressing the device above the rating listed in the “Absolute maximum ratings” table may cause permanent damage to the device. These are stress ratings only and operation of the device at these or any other conditions above those indicated in the operating sections of this specification is not implied. Exposure to Absolute maximum rating conditions for extended periods may affect device reliability. Refer also to the STMicroelectronics sure program and other relevant quality document.

Table 3. Absolute maximum ratings

Symbol	Parameter	Value	Unit
V_{CC}	DC supply voltage	41	V
$-V_{CC}$	Reverse DC supply voltage	- 0.3	V
$-I_{gnd}$	DC reverse ground pin current	- 200	mA
I_{OUT}	DC output current	Internally limited	A
$-I_{OUT}$	Reverse DC output current	- 21	A
I_{IN}	DC input current	+/- 10	mA
V_{CSENSE}	Current sense maximum voltage	- 3 + 15	V V
V_{ESD}	Electrostatic discharge (human body model: $R = 1.5K\Omega$; $C = 100pF$)		
	- Input	4000	V
	- Current sense	2000	V
	- Output	5000	V
	- V_{CC}	5000	V

Table 3. Absolute maximum ratings (continued)

Symbol	Parameter	Value	Unit
E_{MAX}	Maximum switching energy ($L = 0.25\text{mH}$; $R_L = 0\Omega$; $V_{bat} = 13.5\text{V}$; $T_{jstart} = 150^\circ\text{C}$; $I_L = 45\text{A}$)	364	mJ
P_{tot}	Power dissipation $T_C \leq 25^\circ\text{C}$	96.1	W
T_j	Junction operating temperature	Internally limited	$^\circ\text{C}$
T_C	Case operating temperature	- 40 to 150	$^\circ\text{C}$
T_{stg}	Storage temperature	- 55 to 150	$^\circ\text{C}$

2.2 Thermal data

Table 4. Thermal data

Symbol	Parameter	Max. value	Unit
$R_{thj-case}$	Thermal resistance junction-case (max)	1.3	$^\circ\text{C/W}$
$R_{thj-amb}$	Thermal resistance junction-ambient (max)	51.3 ⁽¹⁾	$^\circ\text{C/W}$
		61.3 ⁽²⁾	$^\circ\text{C/W}$

1. When mounted on a standard single-sided FR-4 board with 0.5cm^2 of Cu (at least $35\mu\text{m}$ thick).
2. When mounted on a standard single-sided FR-4 board with 6cm^2 of Cu (at least $35\mu\text{m}$ thick).

2.3 Electrical characteristics

Values specified in this section are for $8\text{V} < V_{CC} < 36\text{V}$; $-40^\circ\text{C} < T_j < 150^\circ\text{C}$, unless otherwise stated.

Table 5. Power

Symbol	Parameter	Test conditions	Min.	Typ.	Max.	Unit
V_{CC}	Operating supply voltage		5.5	13	36	V
V_{USD}	Undervoltage shutdown		3	4	5.5	V
V_{OV}	Overvoltage shutdown		36			V
R_{ON}	On-state resistance	$I_{OUT} = 10\text{A}$; $T_j = 25^\circ\text{C}$;			18	$\text{m}\Omega$
		$I_{OUT} = 10\text{A}$;			32	$\text{m}\Omega$
		$I_{OUT} = 3\text{A}$; $V_{CC} = 6\text{V}$			55	$\text{m}\Omega$
V_{CLAMP}	Clamp voltage	$I_{CC} = 20\text{mA}^{(1)}$	41	48	55	V

Table 5. Power (continued)

Symbol	Parameter	Test conditions	Min.	Typ.	Max.	Unit
I_S	Supply current	Off-state; $V_{CC} = 13V$; $V_{IN} = V_{OUT} = 0V$		10	25	μA
		Off-state; $V_{CC} = 13V$; $V_{IN} = V_{OUT} = 0V$; $T_j = 25^\circ C$		10	20	μA
		On-state; $V_{CC} = 13V$; $V_{IN} = 5V$; $I_{OUT} = 0A$; $R_{SENSE} = 3.9 k\Omega$				5
$I_{L(off1)}$	Off-state output current	$V_{IN} = V_{OUT} = 0V$	0		50	μA
$I_{L(off2)}$	Off-state output current	$V_{IN} = 0$; $V_{OUT} = 3.5V$	-75		0	μA
$I_{L(off3)}$	Off-state output current	$V_{IN} = V_{OUT} = 0V$; $V_{CC} = 13V$; $T_j = 125^\circ C$			5	μA
$I_{L(off4)}$	Off-state output current	$V_{IN} = V_{OUT} = 0V$; $V_{CC} = 13V$; $T_j = 25^\circ C$			3	μA

1. V_{clamp} and V_{OV} are correlated. Typical difference is 5V.

Table 6. Switching ($V_{CC}=13V$)

Symbol	Parameter	Test conditions	Min.	Typ.	Max.	Unit
$t_{d(on)}$	Turn-on delay time	$R_L = 1.3\Omega$ (see Figure 5)	-	50	-	μs
$t_{d(off)}$	Turn-off delay time	$R_L = 1.3\Omega$ (see Figure 5)	-	50	-	μs
$dV_{OUT}/dt_{(on)}$	Turn-on voltage slope	$R_L = 1.3\Omega$ (see Figure 5)	-	See Figure 15	-	V/ μs
$dV_{OUT}/dt_{(off)}$	Turn-off voltage slope	$R_L = 1.3\Omega$ (see Figure 5)	-	See Figure 16	-	V/ μs

Table 7. Logic inputs

Symbol	Parameter	Test conditions	Min.	Typ.	Max.	Unit
V_{IL}	Input low-level voltage				1.25	V
I_{IL}	Low-level input current	$V_{IN} = 1.25V$	1			μA
V_{IH}	Input high-level voltage		3.25			V
I_{IH}	High-level input current	$V_{IN} = 3.25V$			10	μA
$V_{I(hyst)}$	Input hysteresis voltage		0.5			V
V_{ICL}	Input clamp voltage	$I_{IN} = 1mA$	6	6.8	8	V
		$I_{IN} = -1mA$		-0.7		V

Table 8. Current sense (9 V ≤ V_{CC} ≤ 16 V)⁽¹⁾

Symbol	Parameter	Test conditions	Min.	Typ.	Max.	Unit
K ₁	I _{OUT} /I _{SENSE}	I _{OUT} = 1A; V _{SENSE} = 0.5V; T _j = -40 °C to 150 °C	3300	4400	6000	
dK ₁ /K ₁	Current sense ratio drift	I _{OUT} = 1A; V _{SENSE} = 0.5V; T _j = -40 °C to 150 °C	-10		+10	%
K ₂	I _{OUT} /I _{SENSE}	I _{OUT} = 10A; V _{SENSE} = 4V; T _j = -40°C T _j = 25°C to 150°C	4200 4400	4900 4900	6700 6700	
dK ₂ /K ₂	Current sense ratio drift	I _{OUT} = 10A; V _{SENSE} = 4V; T _j = -40°C to 150°C	-8		+8	%
K ₃	I _{OUT} /I _{SENSE}	I _{OUT} = 30A; V _{SENSE} = 4V; T _j = -40°C T _j = 25°C to 150°C	4200 4400	4900 4900	6700 6700	
dK ₃ /K ₃	Current sense ratio drift	I _{OUT} = 30A; V _{SENSE} = 4V; T _j = -40°C to 150°C	-6		+6	%
I _{SENSE0}	Analog sense leakage current	V _{CC} = 6V to 16V; I _{OUT} = 0A; V _{SENSE} = 0V; T _j = -40°C to 150°C	0		10	μA
V _{SENSE}	Max analog sense output voltage	V _{CC} = 5.5V; I _{OUT} = 5A; R _{SENSE} = 10kΩ V _{CC} > 8V, I _{OUT} = 10A; R _{SENSE} = 10kΩ	2 4			V V
V _{SENSEH}	Sense voltage in overtemperature condition	V _{CC} = 13V; R _{SENSE} = 3.9kΩ		5.5		V
R _{VSENSEH}	Analog sense output impedance in overtemperature condition	V _{CC} = 13V; T _j > T _{TSD} ; output open		400		Ω
t _{DSENSE}	Current sense delay response	To 90% I _{SENSE} ⁽²⁾			500	μs

1. See [Figure 4](#).

2. Current sense signal delay after positive input slope.

Table 9. Protections⁽¹⁾

Symbol	Parameter	Test conditions	Min.	Typ.	Max.	Unit
T_{TSD}	Shutdown temperature		150	175	200	°C
T_R	Reset temperature		135			°C
T_{hyst}	Thermal hysteresis		7	15		°C
I_{lim}	DC short circuit current	$V_{CC} = 13V$ $5V < V_{CC} < 36V$	30	45	75 75	A A
V_{demag}	Turn-off output clamp voltage	$I_{OUT} = 2A; V_{IN} = 0V;$ $L = 6mH$	$V_{CC} - 41$	$V_{CC} - 48$	$V_{CC} - 55$	V
V_{ON}	Output voltage drop limitation	$I_{OUT} = 1 A;$ $T_j = -40^{\circ}C$ to $150^{\circ}C$		50		mV

1. To ensure long term reliability under heavy over-load or short circuit conditions, protection and related diagnostic signals must be used together with a proper software strategy. If the device operates under abnormal conditions this software must limit the duration and number of activation cycles.

Table 10. V_{CC} output diode

Symbol	Parameter	Test conditions	Min.	Typ.	Max.	Unit
V_F	Forward on voltage	$-I_{OUT} = 5A; T_j = 150^{\circ}C$	-	-	0.6	V

Figure 4. I_{OUT}/I_{SENSE} versus I_{OUT}

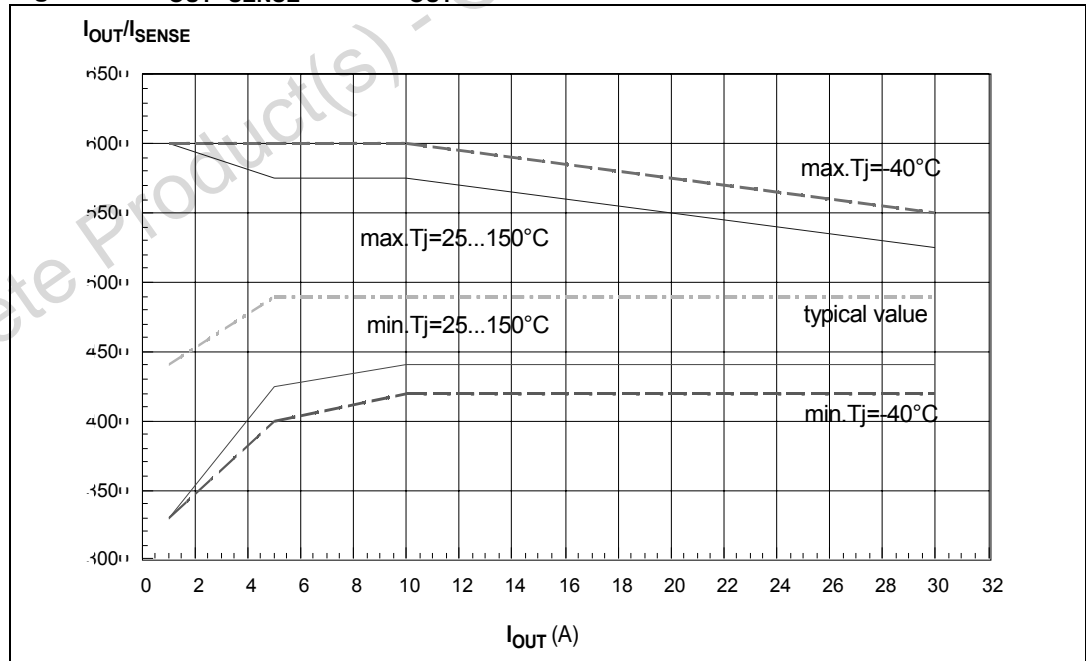

Figure 5. Switching characteristics (resistive load $R_L = 1.3 \Omega$)

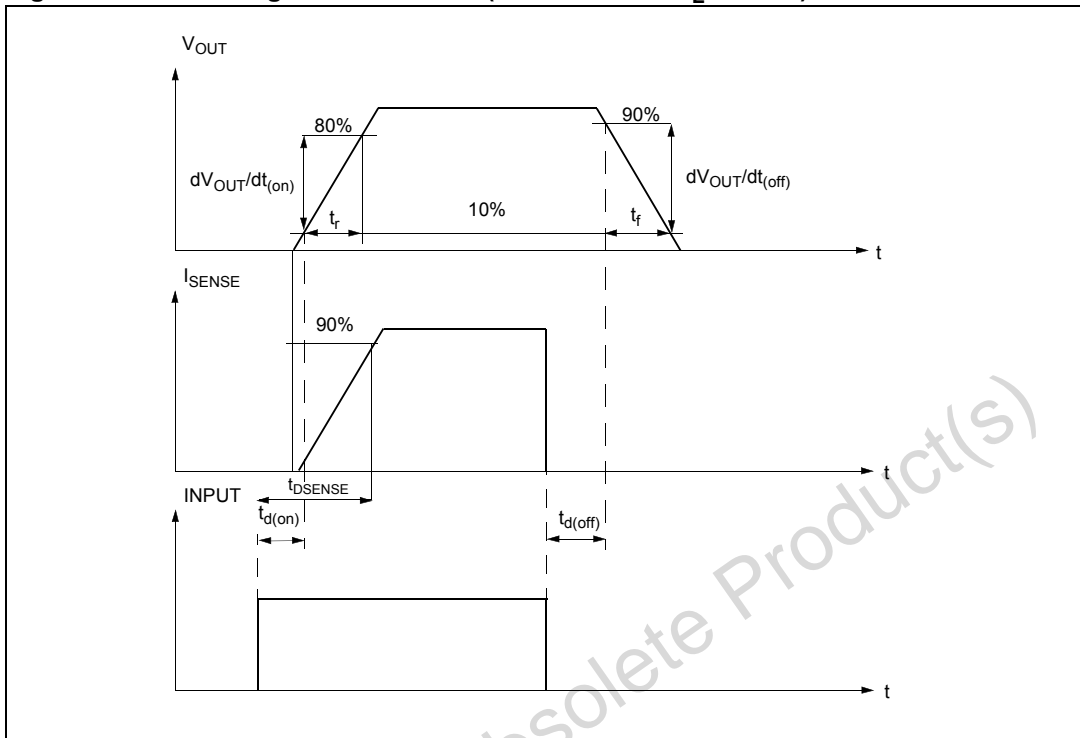

Table 11. Truth table

Conditions	Input	Output	Sense
Normal operation	L	L	0
	H	H	Nominal
Overtemperature	L	L	0
	H	L	V_{SENSEH}
Undervoltage	L	L	0
	H	L	0
Overvoltage	L	L	0
	H	L	0
Short circuit to GND	L	L	0
	H	L	$(T_j < T_{TSD}) 0$ $(T_j > T_{TSD}) V_{SENSEH}$
Short circuit to V_{CC}	L	H	0
	H	H	< Nominal
Negative output voltage clamp	L	L	0

Table 12. Electrical transient requirements (part 1/3)

ISO T/R 7637/1 Test pulse	Test level				Delays and impedance
	I	II	III	IV	
1	- 25V	- 50V	- 75V	- 100V	2ms, 10Ω
2	+ 25V	+ 50V	+ 75V	+ 100V	0.2ms, 10Ω
3a	- 25V	- 50V	- 100V	- 150V	0.1μs, 50Ω
3b	+ 25V	+ 50V	+ 75V	+ 100V	0.1μs, 50Ω
4	- 4V	- 5V	- 6V	- 7V	100ms, 0.01Ω
5	+ 26.5V	+ 46.5V	+ 66.5V	+ 86.5V	400ms, 2Ω

Table 13. Electrical transient requirements (part 2/3)

ISO T/R 7637/1 Test pulse	Test level results			
	I	II	III	IV
1	C	C	C	C
2	C	C	C	C
3a	C	C	C	C
3b	C	C	C	C
4	C	C	C	C
5	C	E	E	E

Table 14. Electrical transient requirements (part 3/3)

Class	Contents
C	All functions of the device are performed as designed after exposure to disturbance.
E	One or more functions of the device are not performed as designed after exposure to disturbance and cannot be returned to proper operation without replacing the device.

Figure 6. Waveforms

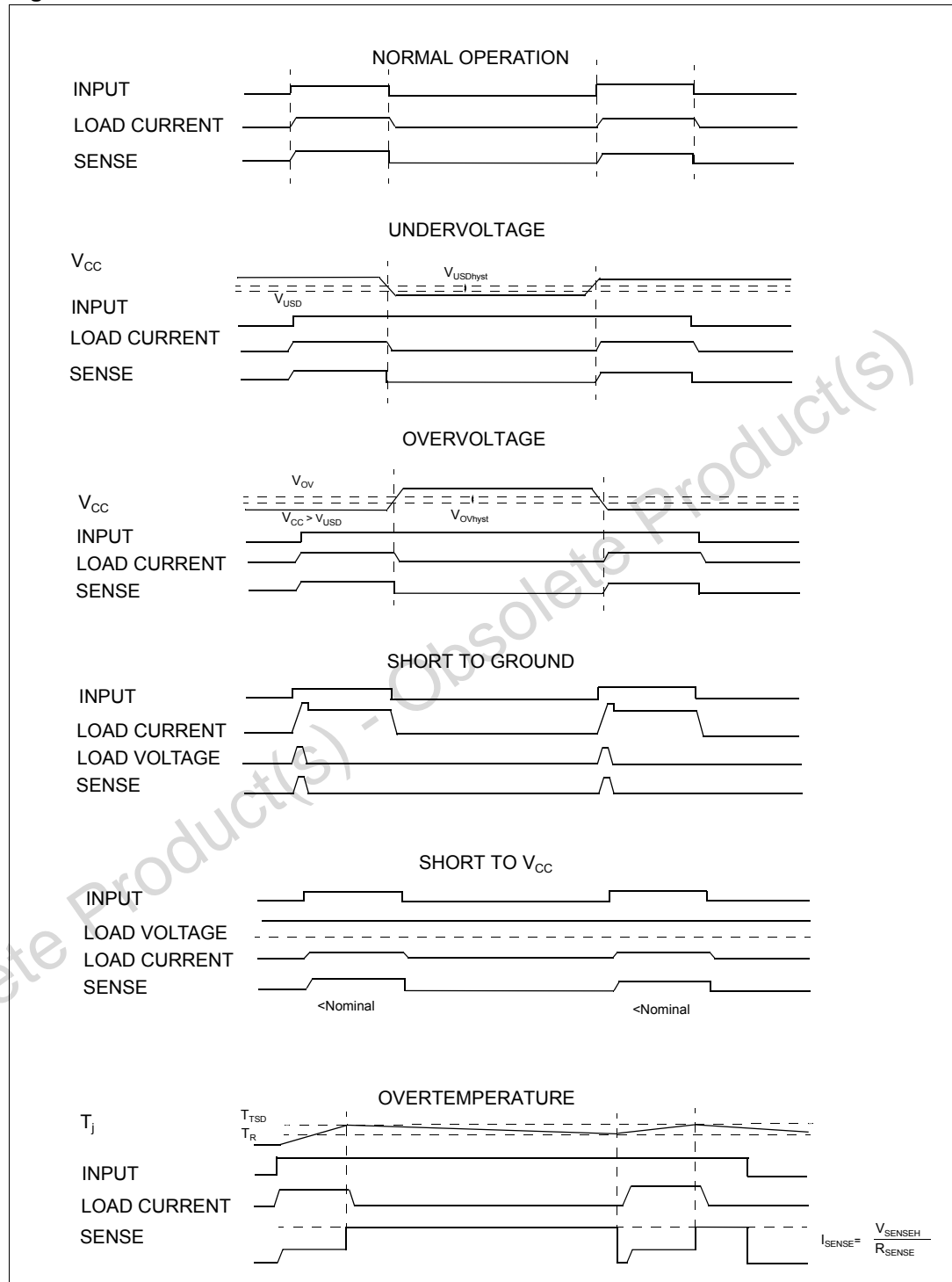

2.4 Electrical characteristics curves

Figure 7. Off-state output current

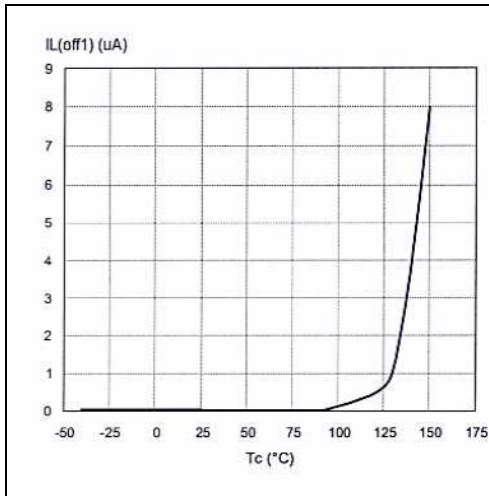

Figure 8. High-level input current

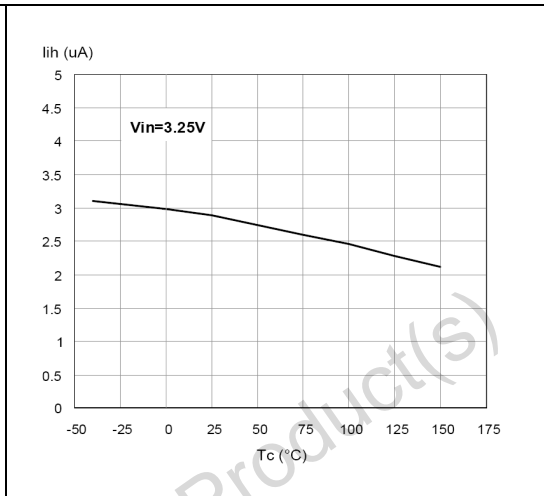

Figure 9. Input clamp voltage

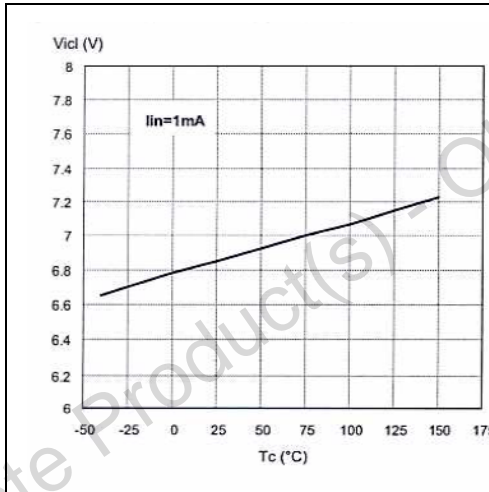

Figure 10. Input high-level voltage

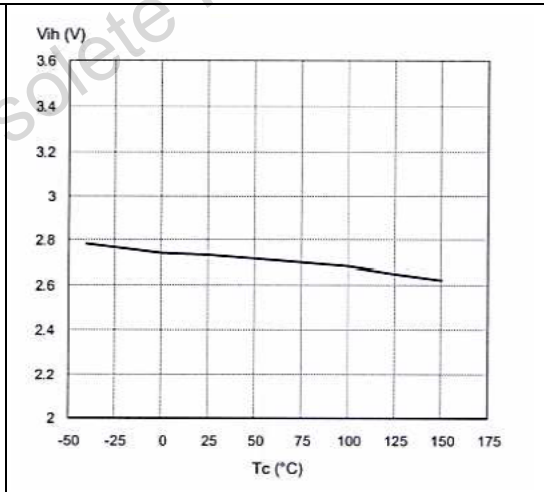

Figure 11. Input low-level voltage

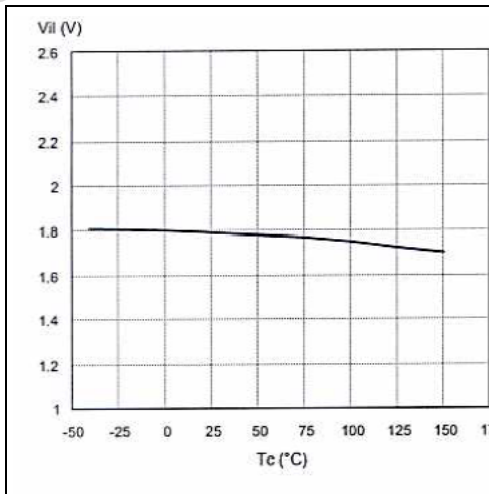

Figure 12. Input hysteresis voltage

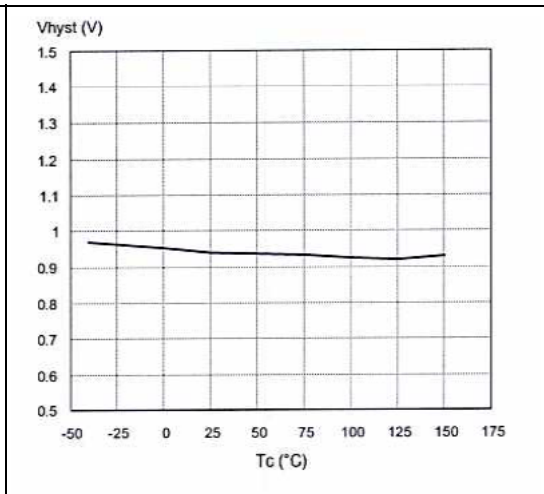

Figure 13. Overvoltage shutdown

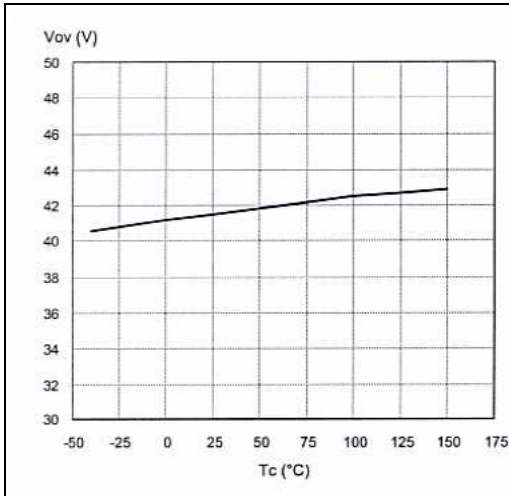

Figure 14. I_{LIM} vs T_{case}

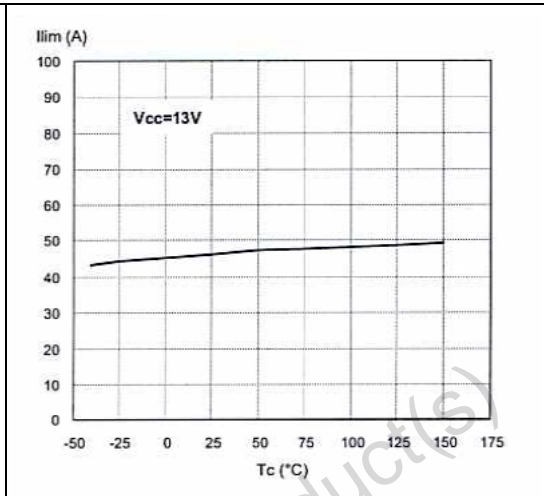

Figure 15. Turn-on voltage slope

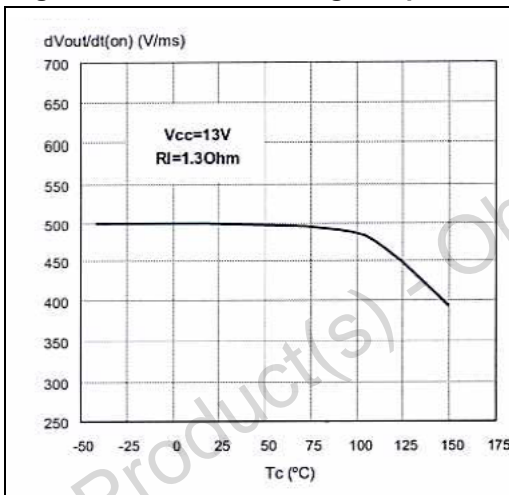

Figure 16. Turn-off voltage slope

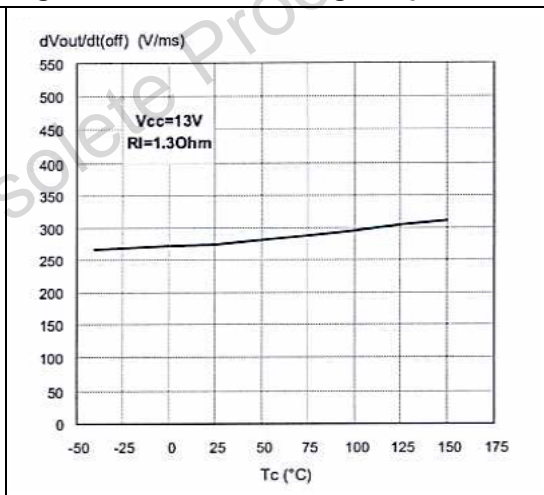

Figure 17. On-state resistance vs T_{CASE}

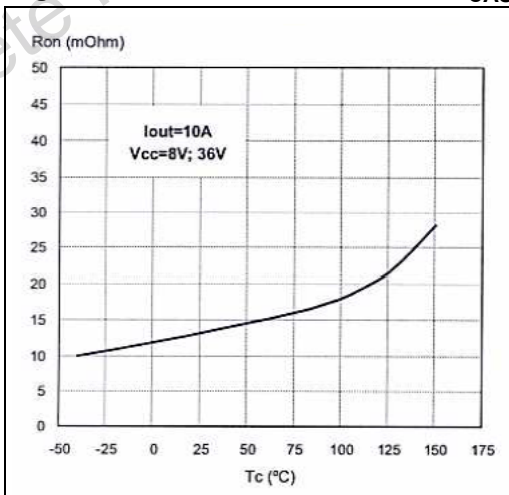
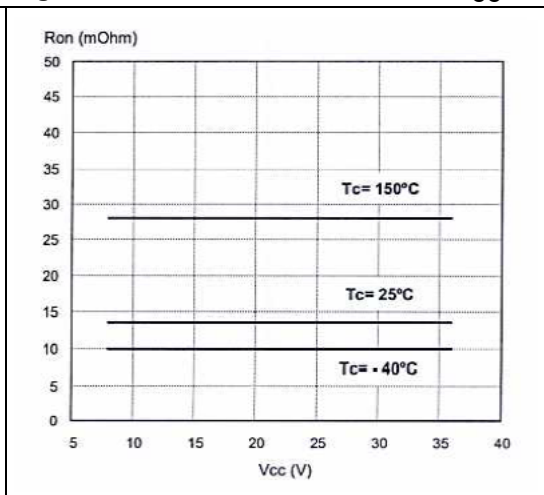

Figure 18. On-state resistance vs V_{CC}



3.1.2 Solution 2: diode (D_{GND}) in the ground line

A resistor ($R_{GND} = 1k\Omega$) should be inserted in parallel to D_{GND} if the device drives an inductive load.

This small signal diode can be safely shared amongst several different HSDs. Also in this case, the presence of the ground network produces a shift ($\approx 600mV$) in the input threshold and in the status output values if the microprocessor ground is not common to the device ground. This shift not varies if more than one HSD shares the same diode/resistor network.

Series resistor in INPUT lines is also required to prevent that, during battery voltage transient, the current exceeds the absolute maximum rating.

Safest configuration for unused INPUT pin is to leave it unconnected, while unused SENSE pin has to be connected to ground pin.

3.2 Load dump protection

D_{ld} is necessary (voltage transient suppressor) if the load dump peak voltage exceeds the V_{CC} max DC rating. The same applies if the device is subject to transients on the V_{CC} line that are greater than the ones shown in the ISO T/R 7637/1 table.

3.3 MCU I/Os protection

If a ground protection network is used and negative transient are present on the V_{CC} line, the control pins is pulled negative. ST suggests to insert a resistor (R_{prot}) in line to prevent the μC I/Os pins to latch-up.

The value of these resistors is a compromise between the leakage current of μC and the current required by the HSD I/Os (Input levels compatibility) with the latch-up limit of μC I/Os.

$$-V_{CCpeak}/I_{latchup} \leq R_{prot} \leq (V_{OH\mu C} - V_{IH} - V_{GND}) / I_{IHmax}$$

Calculation example:

For $V_{CCpeak} = -100V$ and $I_{latchup} \geq 20mA$; $V_{OH\mu C} \geq 4.5V$

$$5k\Omega \leq R_{prot} \leq 65k\Omega$$

Recommended values: $R_{prot} = 10k\Omega$.

3.4 Maximum demagnetization energy

Figure 20. Maximum turn-off current versus load inductance

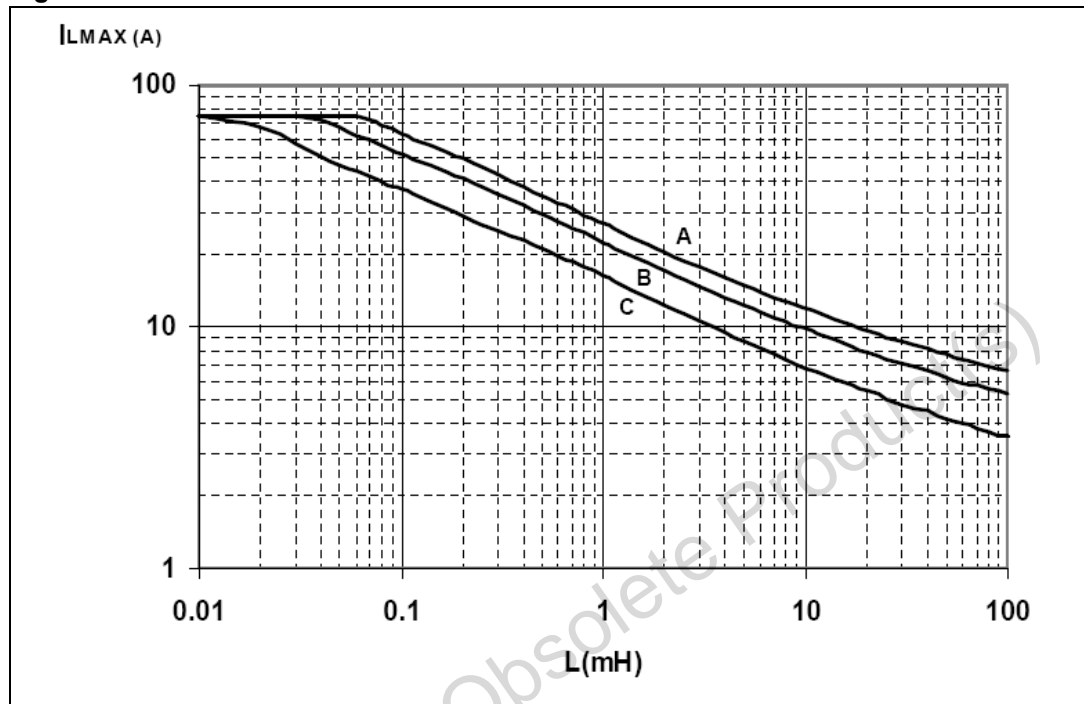

Legend:

A = Single Pulse at $T_{Jstart}=150\text{ }^{\circ}\text{C}$

B = Repetitive pulse at $T_{Jstart}=100\text{ }^{\circ}\text{C}$

C = Repetitive Pulse at $T_{Jstart}=125\text{ }^{\circ}\text{C}$

Conditions:

$V_{CC}=13.5\text{ V}$

Values are generated with $R_L=0\text{ }\Omega$

In case of repetitive pulses, T_{jstart} (at beginning of each demagnetization) of every pulse must not exceed the temperature specified above for curves B and C.

Figure 21. Demagnetization

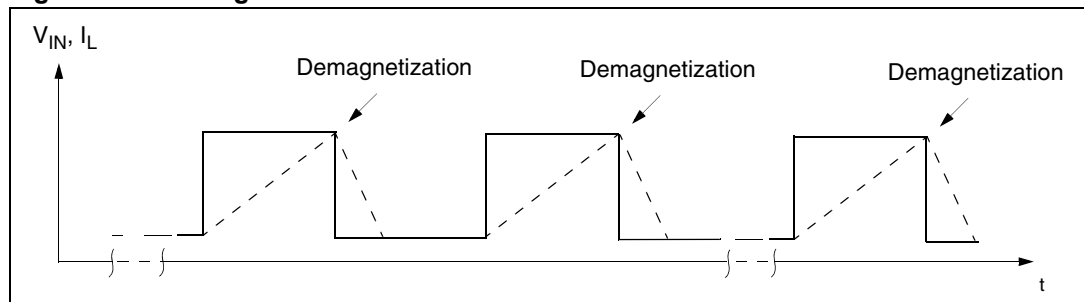

4 Package and PCB thermal data

4.1 P²PAK thermal data

Figure 22. P²PAK PC board

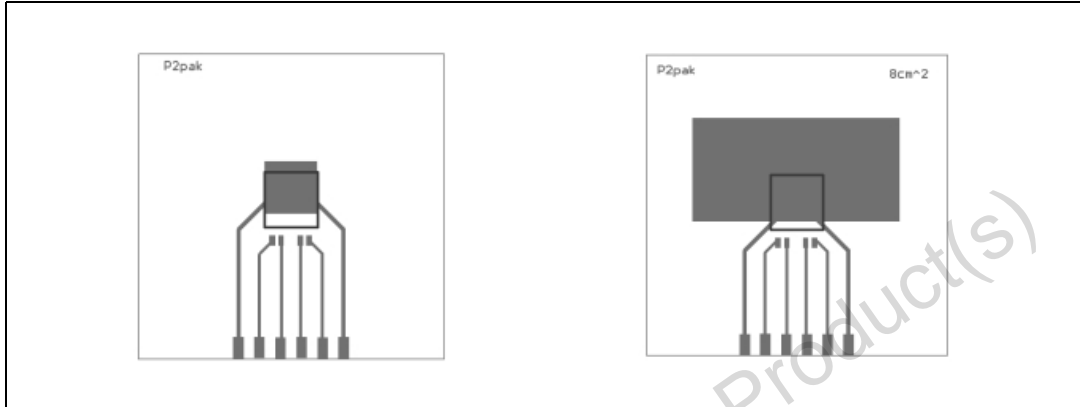

Note: Layout condition of R_{th} and Z_{th} measurements (PCB FR4 area=60 mm x 60 mm, PCB thickness=2 mm, Cu thickness=35 μ m, Copper areas: 0.97 cm², 8 cm²).

Figure 23. $R_{thj-amb}$ vs PCB copper area in open box free air condition

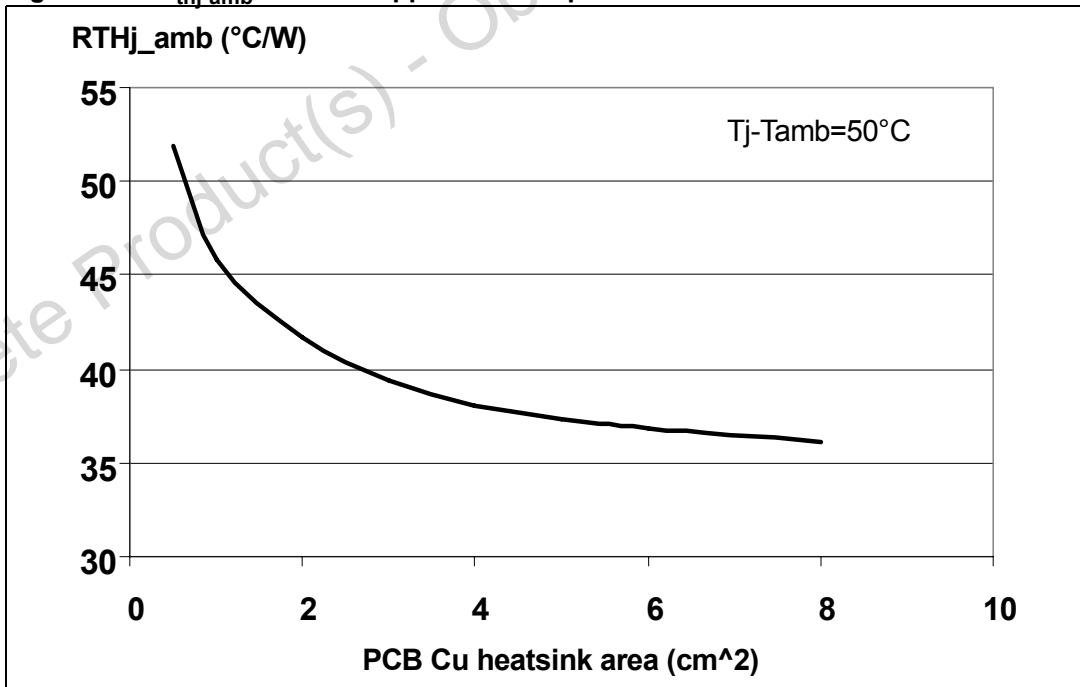
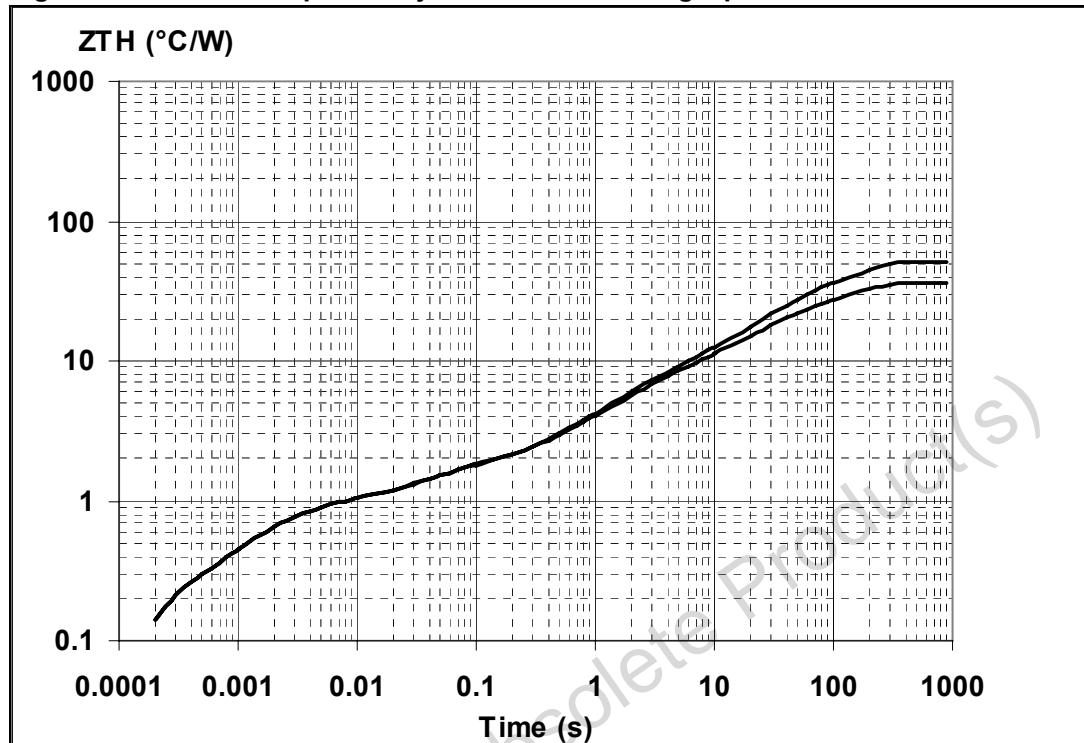

Figure 24. Thermal impedance junction ambient single pulse



Equation 1: pulse calculation formula

$$Z_{TH\delta} = R_{TH} \cdot \delta + Z_{THtp}(1 - \delta)$$

where $\delta = t_p / T$

Figure 25. Thermal fitting model of a quad channel HSD in P²PAK

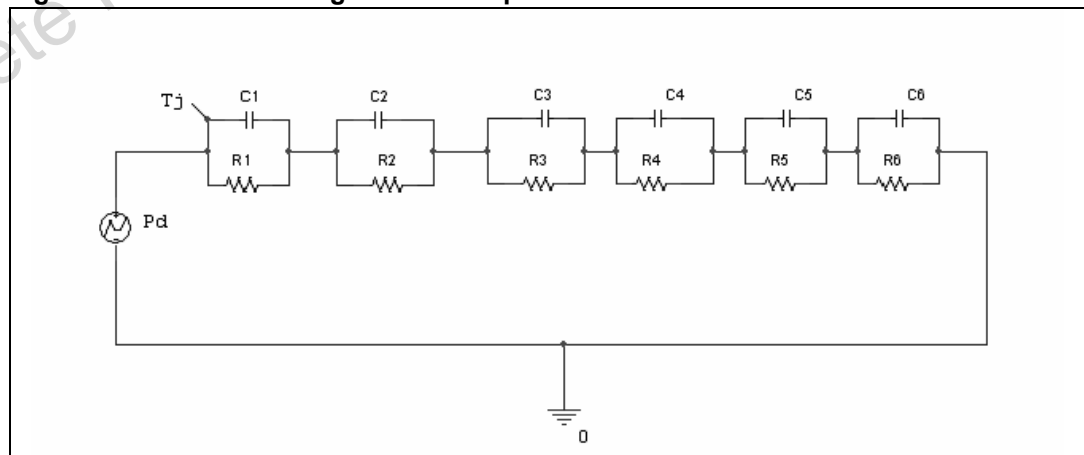

Table 15. Thermal parameter

Area/island (cm ²)	0.5	6
R1 (°C/W)	0.02	-
R2 (°C/W)	0.1	-
R3 (°C/W)	0.22	-
R4 (°C/W)	4	-
R5 (°C/W)	9	-
R6 (°C/W)	37	22
C1 (W.s/°C)	0.00015	-
C2 (W.s/°C)	0.007	-
C3 (W.s/°C)	0.015	-
C4 (W.s/°C)	0.4	-
C5 (W.s/°C)	2	-
C6 (W.s/°C)	3	5

5 Package and packing information

5.1 ECOPACK® packages

In order to meet environmental requirements, ST offers these devices in different grades of ECOPACK® packages, depending on their level of environmental compliance. ECOPACK® specifications, grade definitions and product status are available at: www.st.com.

ECOPACK® is an ST trademark.

5.1.1 P²PAK mechanical data

Figure 26. P²PAK package dimensions

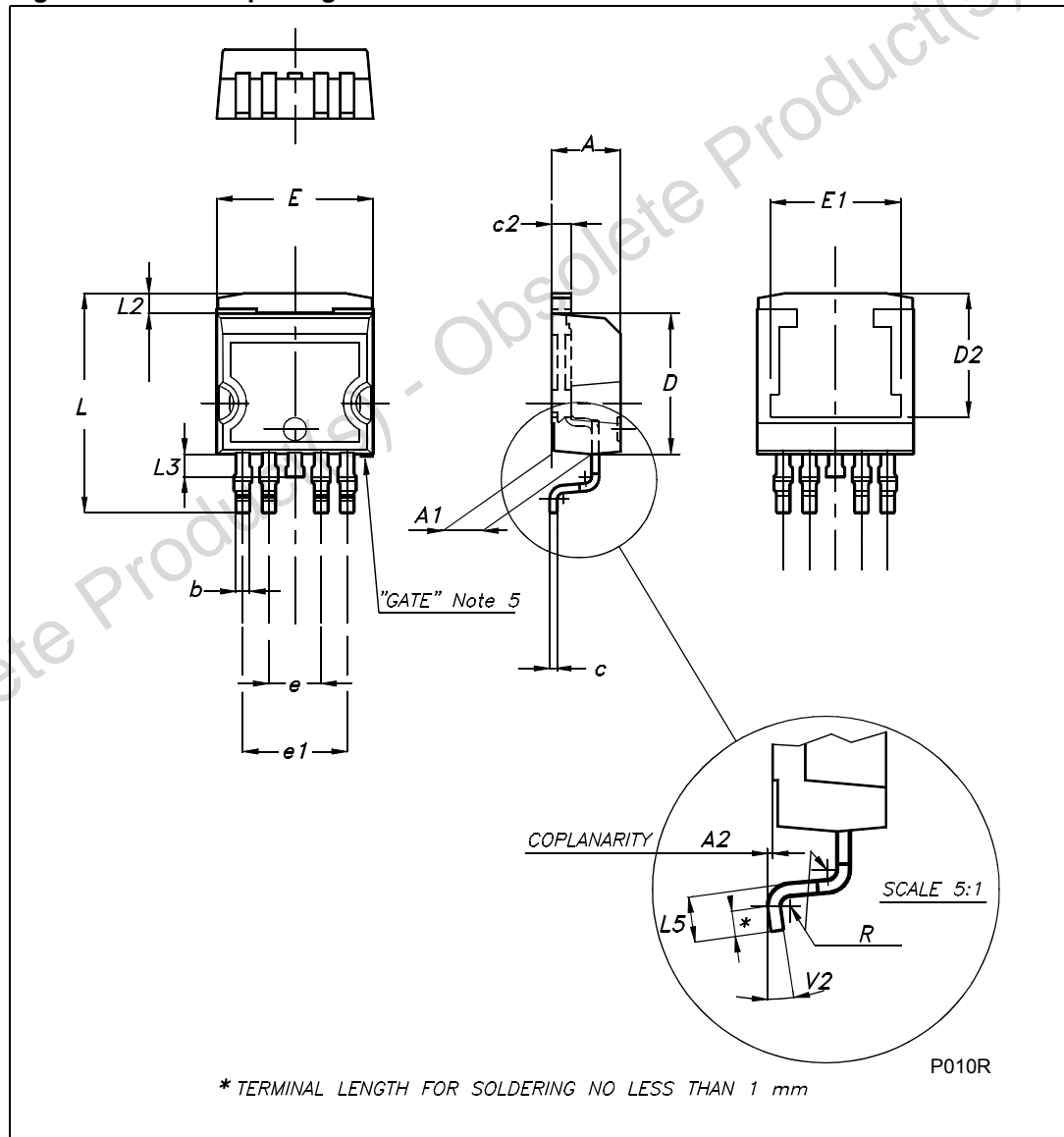

Table 16. P²PAK mechanical data

Symbol	millimeters		
	Min	Typ	Max
A	4.30		4.80
A1	2.40		2.80
A2	0.03		0.23
b	0.80		1.05
c	0.45		0.60
c2	1.17		1.37
D	8.95		9.35
D2		8.00	
E	10.00		10.40
E1		8.50	
e	3.20		3.60
e1	6.60		7.00
L	13.70		14.50
L2	1.25		1.40
L3	0.90		1.70
L5	1.55		2.40
R		0.40	
Package weight	0°		8°

5.2 P²PAK packing information

Figure 27. P²PAK tube shipment (no suffix)

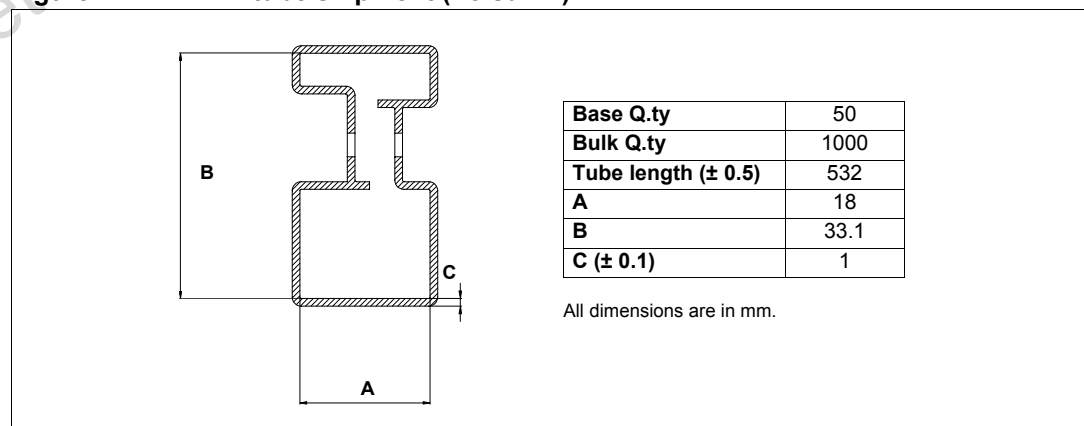
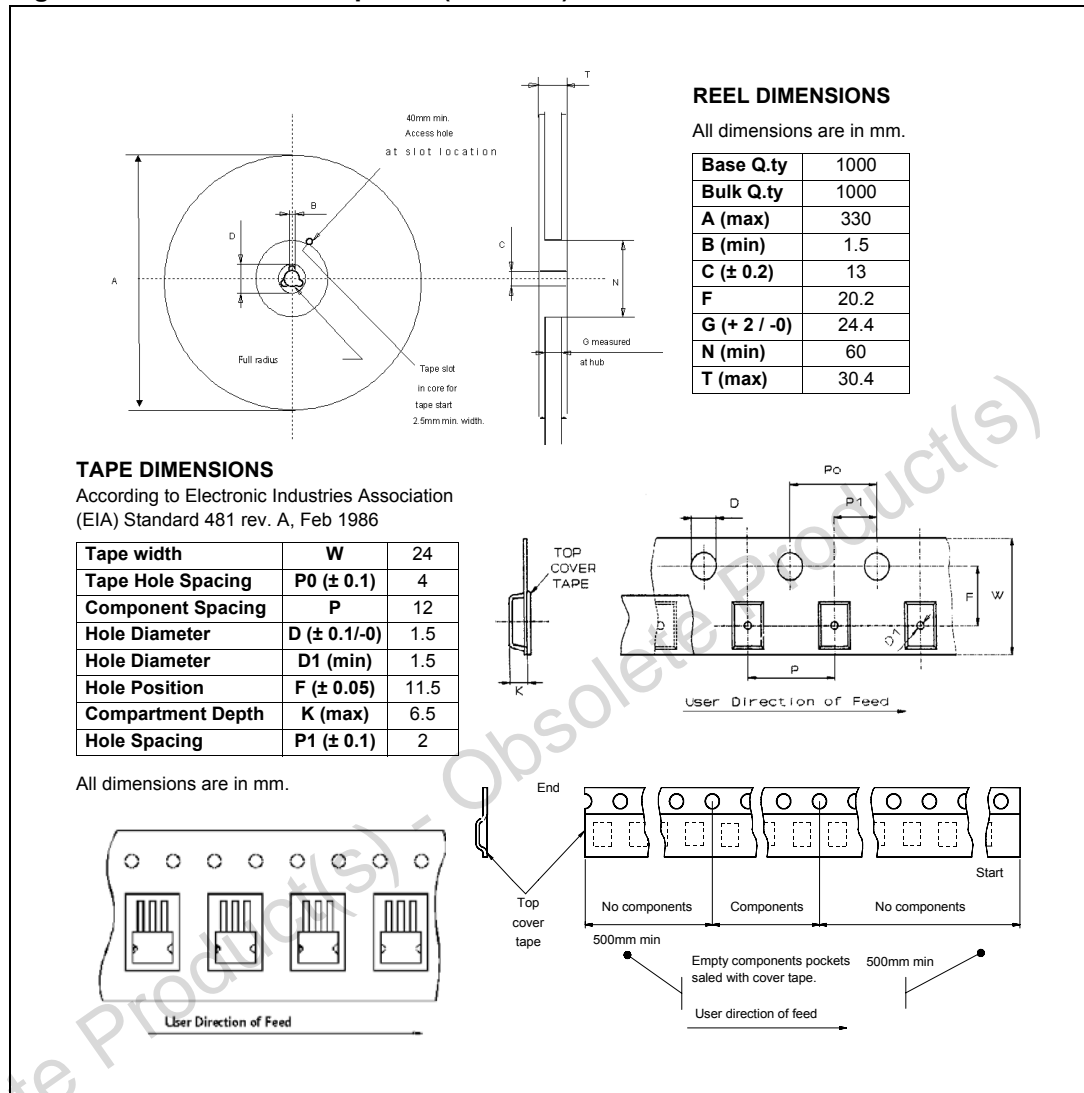

Figure 28. P²PAK tube shipment (no suffix)



6 Revision history

Table 17. Document revision history

Date	Revision	Changes
01-Dec-2005	1	Initial release.
22-Oct-2009	2	Updated Table 8: Current sense (9 V ≤ VCC ≤ 16 V)
25-Sep-2013	3	Updated Disclaimer.

Obsolete Product(s) - Obsolete Product(s)

Please Read Carefully:

Information in this document is provided solely in connection with ST products. STMicroelectronics NV and its subsidiaries ("ST") reserve the right to make changes, corrections, modifications or improvements, to this document, and the products and services described herein at any time, without notice.

All ST products are sold pursuant to ST's terms and conditions of sale.

Purchasers are solely responsible for the choice, selection and use of the ST products and services described herein, and ST assumes no liability whatsoever relating to the choice, selection or use of the ST products and services described herein.

No license, express or implied, by estoppel or otherwise, to any intellectual property rights is granted under this document. If any part of this document refers to any third party products or services it shall not be deemed a license grant by ST for the use of such third party products or services, or any intellectual property contained therein or considered as a warranty covering the use in any manner whatsoever of such third party products or services or any intellectual property contained therein.

UNLESS OTHERWISE SET FORTH IN ST'S TERMS AND CONDITIONS OF SALE ST DISCLAIMS ANY EXPRESS OR IMPLIED WARRANTY WITH RESPECT TO THE USE AND/OR SALE OF ST PRODUCTS INCLUDING WITHOUT LIMITATION IMPLIED WARRANTIES OF MERCHANTABILITY, FITNESS FOR A PARTICULAR PURPOSE (AND THEIR EQUIVALENTS UNDER THE LAWS OF ANY JURISDICTION), OR INFRINGEMENT OF ANY PATENT, COPYRIGHT OR OTHER INTELLECTUAL PROPERTY RIGHT.

ST PRODUCTS ARE NOT DESIGNED OR AUTHORIZED FOR USE IN: (A) SAFETY CRITICAL APPLICATIONS SUCH AS LIFE SUPPORTING, ACTIVE IMPLANTED DEVICES OR SYSTEMS WITH PRODUCT FUNCTIONAL SAFETY REQUIREMENTS; (B) AERONAUTIC APPLICATIONS; (C) AUTOMOTIVE APPLICATIONS OR ENVIRONMENTS, AND/OR (D) AEROSPACE APPLICATIONS OR ENVIRONMENTS. WHERE ST PRODUCTS ARE NOT DESIGNED FOR SUCH USE, THE PURCHASER SHALL USE PRODUCTS AT PURCHASER'S SOLE RISK, EVEN IF ST HAS BEEN INFORMED IN WRITING OF SUCH USAGE, UNLESS A PRODUCT IS EXPRESSLY DESIGNATED BY ST AS BEING INTENDED FOR "AUTOMOTIVE, AUTOMOTIVE SAFETY OR MEDICAL" INDUSTRY DOMAINS ACCORDING TO ST PRODUCT DESIGN SPECIFICATIONS. PRODUCTS FORMALLY ESCC, QML OR JAN QUALIFIED ARE DEEMED SUITABLE FOR USE IN AEROSPACE BY THE CORRESPONDING GOVERNMENTAL AGENCY.

Resale of ST products with provisions different from the statements and/or technical features set forth in this document shall immediately void any warranty granted by ST for the ST product or service described herein and shall not create or extend in any manner whatsoever, any liability of ST.

ST and the ST logo are trademarks or registered trademarks of ST in various countries.

Information in this document supersedes and replaces all information previously supplied.

The ST logo is a registered trademark of STMicroelectronics. All other names are the property of their respective owners.

© 2013 STMicroelectronics - All rights reserved

STMicroelectronics group of companies

Australia - Belgium - Brazil - Canada - China - Czech Republic - Finland - France - Germany - Hong Kong - India - Israel - Italy - Japan - Malaysia - Malta - Morocco - Philippines - Singapore - Spain - Sweden - Switzerland - United Kingdom - United States of America

www.st.com

