

Ultra Fast NPT - IGBT®

The Ultra Fast 650V NPT-IGBT® family of products is the newest generation of IGBTs optimized for outstanding ruggedness and best trade-off between conduction and switching losses.

Features

- Low Saturation Voltage
- Low Tail Current
- RoHS Compliant
- Short Circuit Withstand Rated
- High Frequency Switching
- Ultra Low Leakage Current

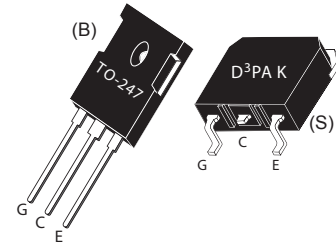

Combi (IGBT and Diode)



Unless stated otherwise, Microsemi discrete IGBTs contain a single IGBT die. This device is recommended for applications such as induction heating (IH), motor control, general purpose inverters and uninterruptible power supplies (UPS).

MAXIMUM RATINGS

 All Ratings: $T_C = 25^\circ\text{C}$ unless otherwise specified.

Symbol	Parameter	Ratings	Unit
V_{CES}	Collector Emitter Voltage	650	V
V_{GE}	Gate-Emitter Voltage	± 30	
I_{C1}	Continuous Collector Current @ $T_C = 25^\circ\text{C}$	118	A
I_{C2}	Continuous Collector Current @ $T_C = 110^\circ\text{C}$	56	
I_{CM}	Pulsed Collector Current ^①	224	
SCWT	Short Circuit Withstand Time: $V_{CE} = 325V, V_{GE} = 15V, T_C = 125^\circ\text{C}$	10	μs
P_D	Total Power Dissipation @ $T_C = 25^\circ\text{C}$	543	W
T_J, T_{STG}	Operating and Storage Junction Temperature Range	-55 to 150	$^\circ\text{C}$
T_L	Max. Lead Temp. for Soldering: 0.063" from Case for 10 Sec.	300	

STATIC ELECTRICAL CHARACTERISTICS

Symbol	Parameter	Min	Typ	Max	Unit
$V_{(BR)CES}$	Collector-Emitter Breakdown Voltage ($V_{GE} = 0V, I_C = 450\mu\text{A}$)	650			Volts
$V_{GE(TH)}$	Gate Threshold Voltage ($V_{CE} = V_{GE}, I_C = 1.0\text{mA}, T_J = 25^\circ\text{C}$)	3.5	5.0	6.5	
$V_{CE(ON)}$	Collector-Emitter On Voltage ($V_{GE} = 15V, I_C = 45A, T_J = 25^\circ\text{C}$)		1.9	2.4	
	Collector-Emitter On Voltage ($V_{GE} = 15V, I_C = 45A, T_J = 125^\circ\text{C}$)		2.4		
	Collector-Emitter On Voltage ($V_{GE} = 15V, I_C = 90A, T_J = 25^\circ\text{C}$)		2.5		
I_{CES}	Collector Cut-off Current ($V_{CE} = 650V, V_{GE} = 0V, T_J = 25^\circ\text{C}$) ^②		20	450	μA
	Collector Cut-off Current ($V_{CE} = 650V, V_{GE} = 0V, T_J = 125^\circ\text{C}$) ^②		200		
I_{GES}	Gate-Emitter Leakage Current ($V_{GE} = \pm 20V$)			± 250	nA

CAUTION: These Devices are Sensitive to Electrostatic Discharge. Proper Handling Procedures Should Be Followed.

Symbol	Parameter	Test Conditions	Min	Typ	Max	Unit
C_{ies}	Input Capacitance	Capacitance $V_{GE} = 0V, V_{CE} = 25V$ $f = 1MHz$		2900		pF
C_{oes}	Output Capacitance			548		
C_{res}	Reverse Transfer Capacitance			268		
V_{GEP}	Gate to Emitter Plateau Voltage	Gate Charge		7.5		V
$Q_g^{(3)}$	Total Gate Charge	$V_{GE} = 15V$		150	203	nC
Q_{ge}	Gate-Emitter Charge	$V_{CE} = 325V$		18	24	
Q_{gc}	Gate- Collector Charge	$I_C = 45A$		74	100	
$t_{d(on)}$	Turn-On Delay Time	Inductive Switching (25°C) $V_{CC} = 433V$ $V_{GE} = 15V$ $I_C = 45A$		15		ns
t_r	Current Rise Time			32		
$t_{d(off)}$	Turn-Off Delay Time			100		
t_f	Current Fall Time			50		
$E_{on}^{(5)}$	Turn-On Switching Energy	$R_G = 5\Omega^{(4)}$		830	1245	μJ
$E_{off}^{(6)}$	Turn-Off Switching Energy	$T_J = +25^\circ C$		580	875	
$t_{d(on)}$	Turn-On Delay Time	Inductive Switching (125°C) $V_{CC} = 433V$ $V_{GE} = 15V$ $I_C = 45A$		15		ns
t_r	Current Rise Time			32		
$t_{d(off)}$	Turn-Off Delay Time			123		
t_f	Current Fall Time			52		
$E_{on}^{(5)}$	Turn-On Switching Energy	$R_G = 5\Omega^{(4)}$		850	1275	μJ
$E_{off}^{(6)}$	Turn-Off Switching Energy	$T_J = +125^\circ C$		800	1160	

THERMAL AND MECHANICAL CHARACTERISTICS

Symbol	Characteristic	Min	Typ	Max	Unit
$R_{\theta JC}$	Junction to Case Thermal Resistance (IGBT)			0.23	$^\circ C/W$
	Junction to Case Thermal Resistance (Diode)			2.0	
$R_{\theta JA}$	Junction to Ambient Thermal Resistance			40	
W_T	Package Weight		0.22		oz
			6.2		g
Torque	Mounting Torque (TO-247 Package), 4-40 or M3 screw			10	in-lbf
				6.2	N-m

- 1 Repetitive Rating: Pulse width and case temperature limited by maximum junction temperature.
 - 2 Pulse test: Pulse Width < 380μs, duty cycle < 2%.
 - 3 See Mil-Std-750 Method 3471.
 - 4 R_G is external gate resistance, not including internal gate resistance or gate driver impedance. (MIC4452)
 - 5 E_{on} is the clamped inductive turn on energy that includes a commutating diode reverse transient current in the IGBT turn on energy loss. A combi device is used for the clamping diode.
 - 6 E_{off} is the clamped inductive turn-off energy measured in accordance with JEDEC standard JESD24-1.
- Microsemi reserves the right to change, without notice, the specifications and information contained herein.

TYPICAL PERFORMANCE CURVES

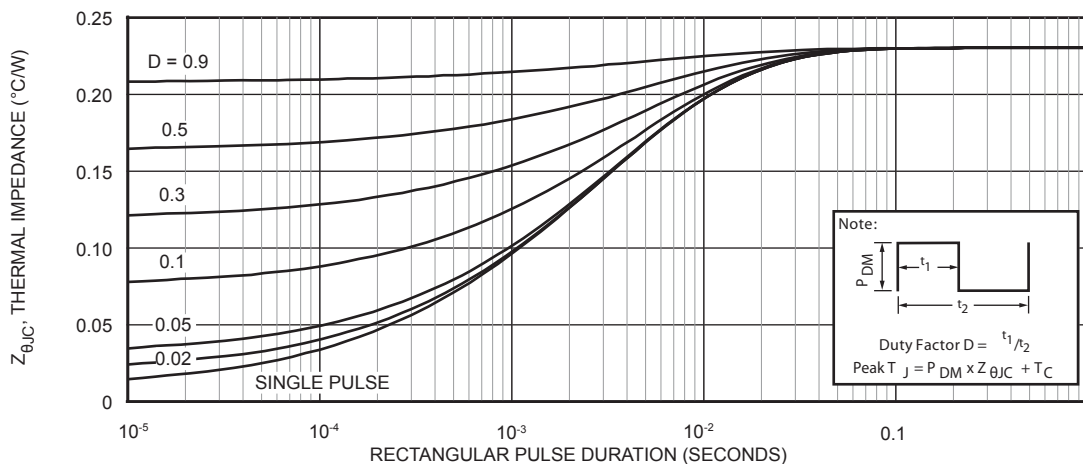

FIGURE 1. Maximum Effective Transient Thermal Impedance, Junction-To-Case vs Pulse Duration

TYPICAL PERFORMANCE CURVES

APT45GR65B_SSCD10

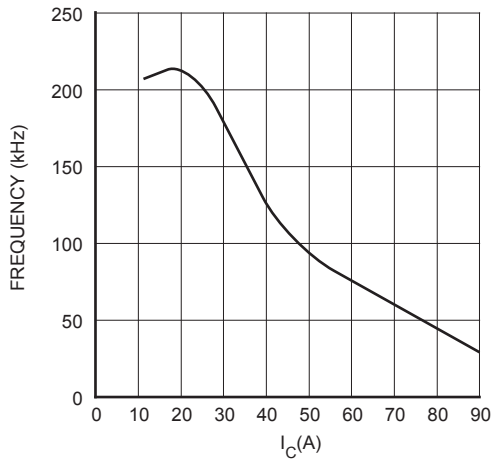

FIGURE 2. Max Frequency vs Current ($T_{case} = 75^{\circ}C$)

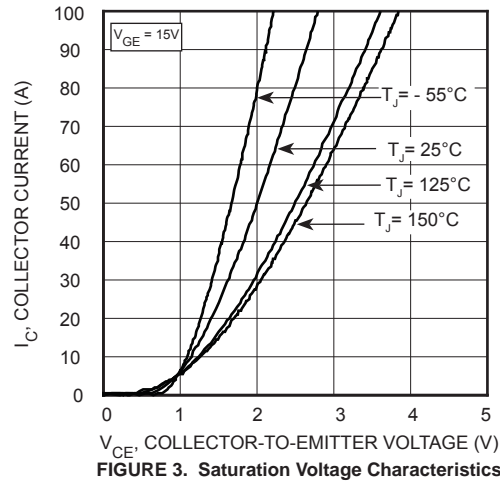

FIGURE 3. Saturation Voltage Characteristics

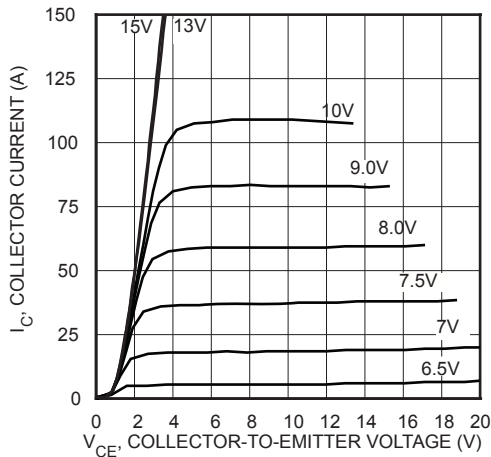

FIGURE 4. Output Characteristics ($T_j = 25^{\circ}C$)

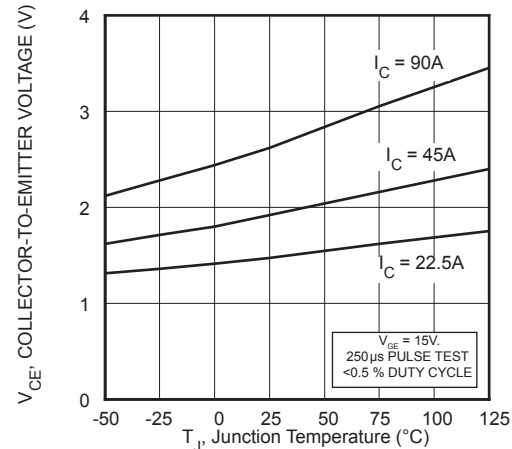

FIGURE 5. On State Voltage vs Junction Temperature

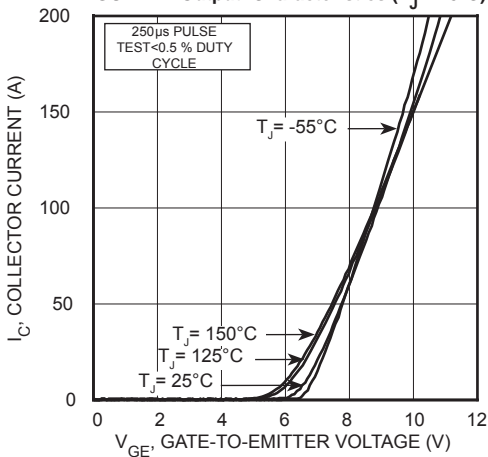

FIGURE 6. Transfer Characteristics

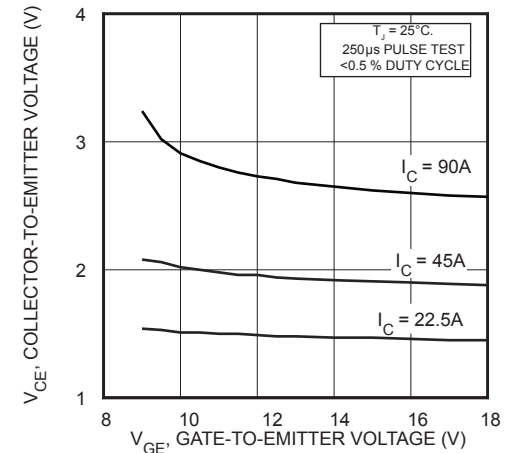

FIGURE 7. On State Voltage vs Gate-to-Emitter Voltage

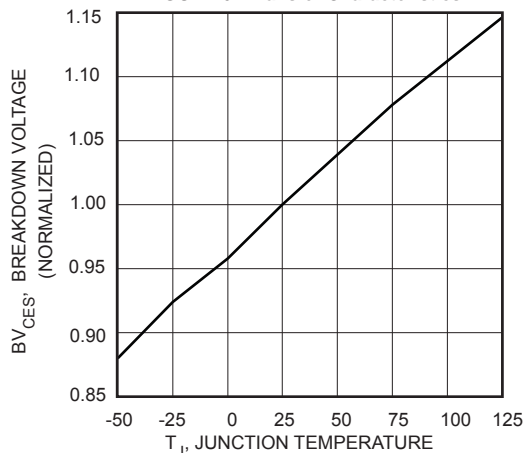

FIGURE 8. Breakdown Voltage vs Junction Temperature

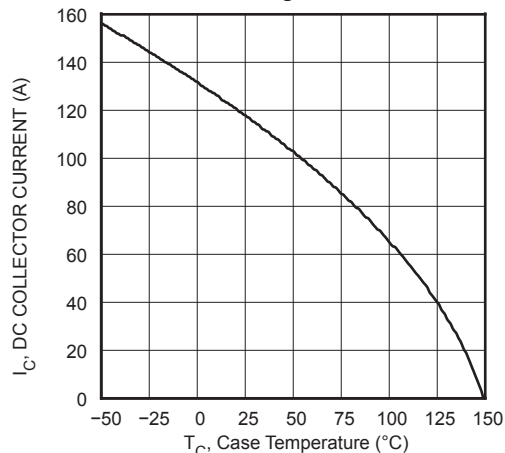

FIGURE 9. DC Collector Current vs Case Temperature

TYPICAL PERFORMANCE CURVES

APT45GR65B_SSCD10

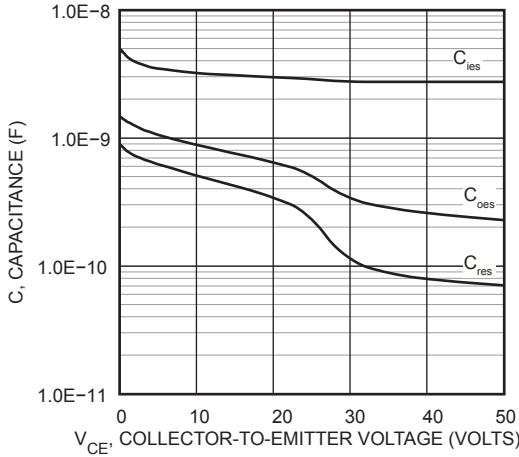

FIGURE 10. Capacitance vs Collector-To-Emitter Voltage

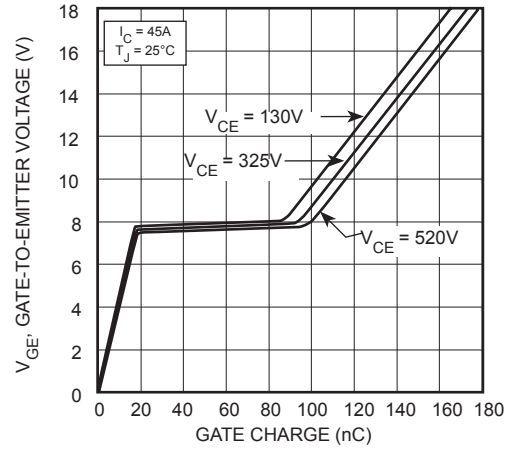

FIGURE 11. Gate charge

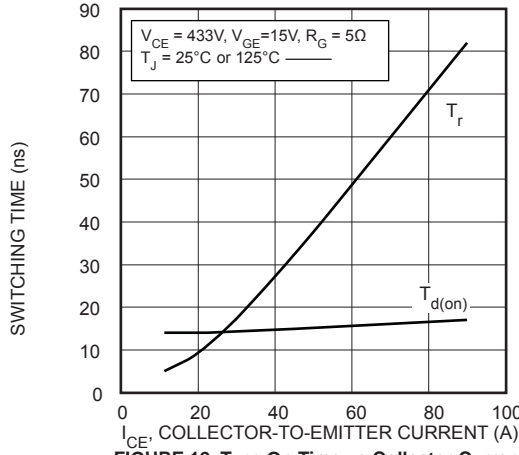

FIGURE 12. Turn-On Time vs Collector Current

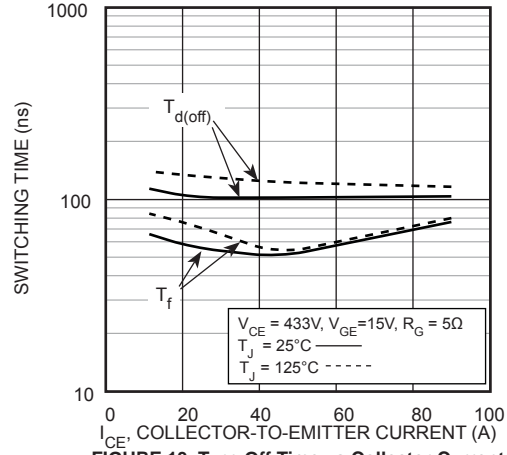

FIGURE 13. Turn-Off Time vs Collector Current

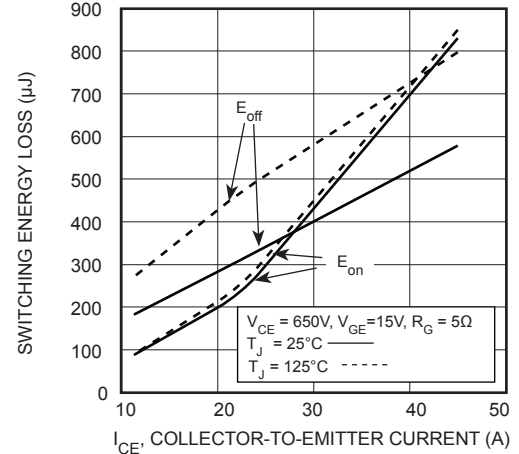

FIGURE 14. Energy Loss vs Collector Current

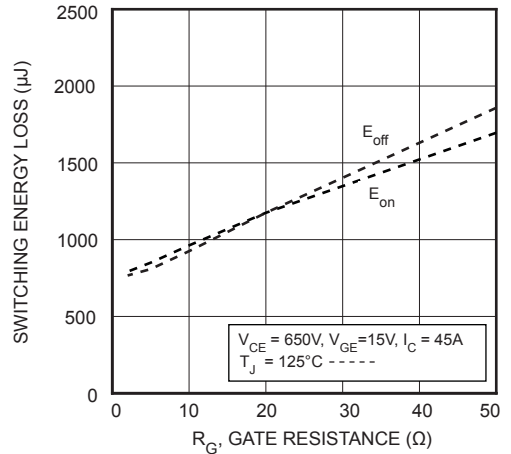

FIGURE 15. Energy Loss vs Gate Resistance

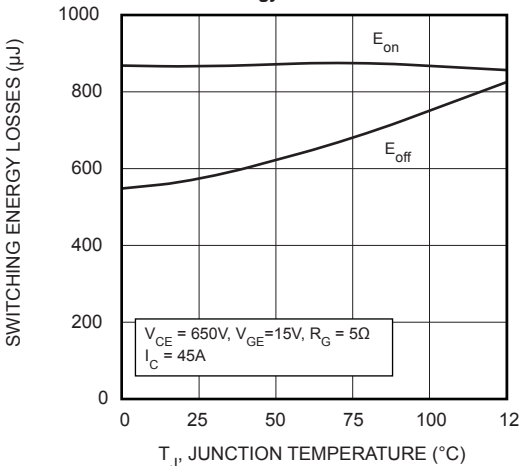

FIGURE 16. Energy Losses vs Junction Temperature

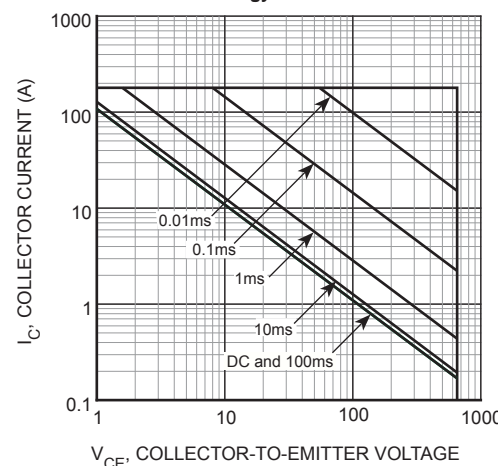

FIGURE 17. Minimum Switching Safe Operating Area

ZERO RECOVERY LOW LEAKAGE SIC ANTI-PARALLEL DIODE

MAXIMUM RATINGS

All Ratings: $T_C = 25^\circ\text{C}$ unless otherwise specified.

Symbol	Characteristic / Test Conditions	Ratings	Unit
I_F	Maximum D.C. Forward Current	$T_C = 25^\circ\text{C}$	17
		$T_C = 100^\circ\text{C}$	9
I_{FRM}	Repetitive Peak Forward Surge Current ($T_J = 45^\circ\text{C}$, $t_p = 10\text{ms}$, Half Sine Wave)	50	Amps
I_{FSM}	Non-Repetitive Forward Surge Current ($T_J = 25^\circ\text{C}$, $t_p = 10\text{ms}$, Half Sine)	110	

STATIC ELECTRICAL CHARACTERISTICS

Symbol	Characteristic / Test Conditions	Min	Typ	Max	Unit
V_F	Forward Voltage		$I_F = 10\text{A}$, $T_J = 25^\circ\text{C}$	1.5	Volts
			$I_F = 10\text{A}$, $T_J = 150^\circ\text{C}$	2.0	
Q_c	Total Capacitive Charge $V_R = 300\text{V}$, $I_F = 10\text{A}$, $di/dt = -500\text{A}/\mu\text{s}$, $T_J = 25^\circ\text{C}$		80		nC

TYPICAL PERFORMANCE CURVES

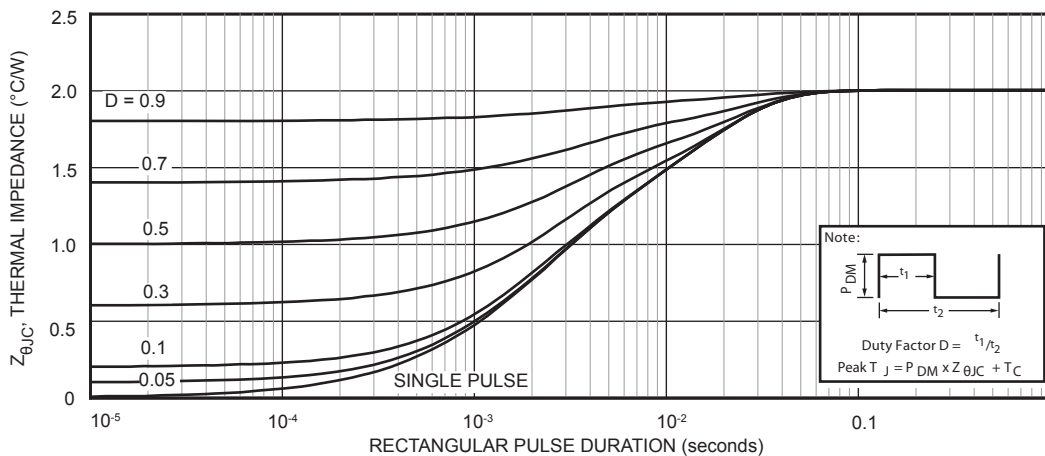

FIGURE 18. MAXIMUM EFFECTIVE TRANSIENT THERMAL IMPEDANCE, JUNCTION-TO-CASE vs. PULSE DURATION

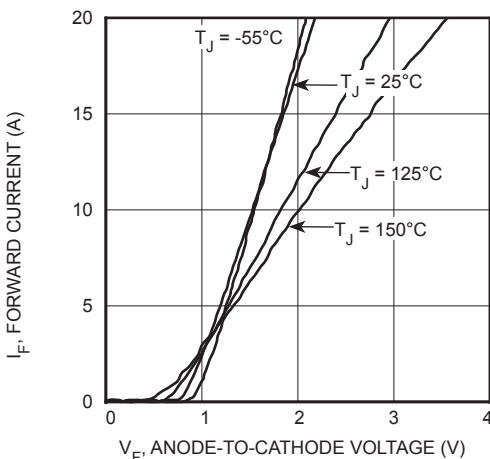

FIGURE 19. Forward Current vs. Forward Voltage

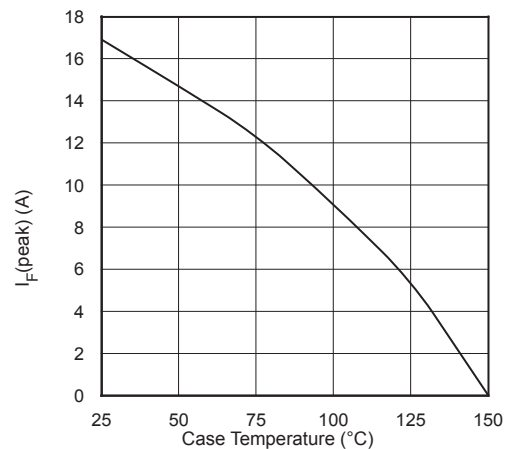

FIGURE 20. Maximum Forward Current vs. Case Temperature

TYPICAL PERFORMANCE CURVES

APT45GR65B_SSCD10

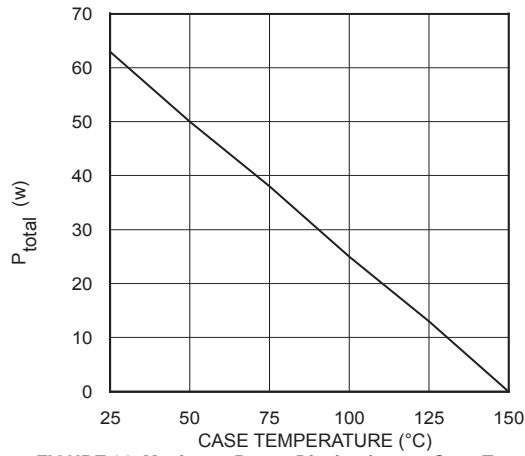

FIGURE 21. Maximum Power Dissipation vs. Case Temperature

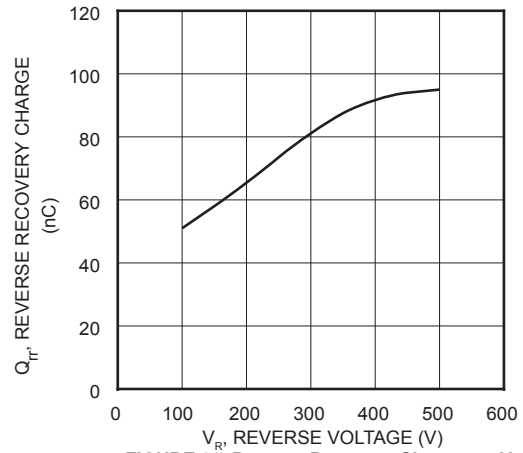

FIGURE 22. Reverse Recovery Charge vs. V_R

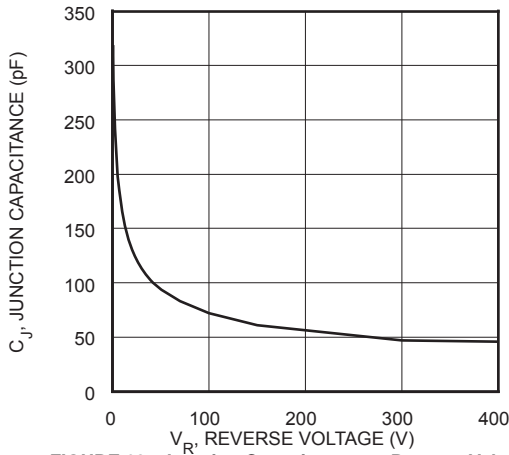
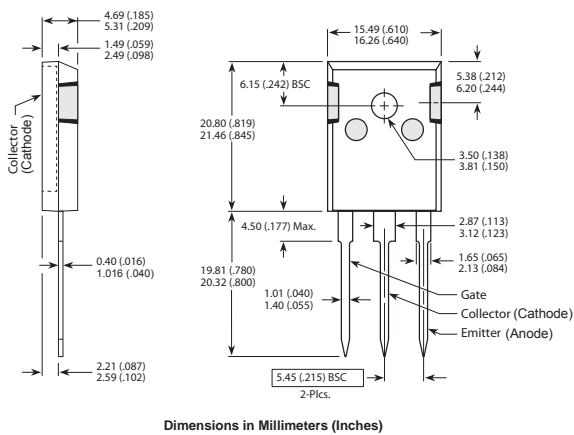
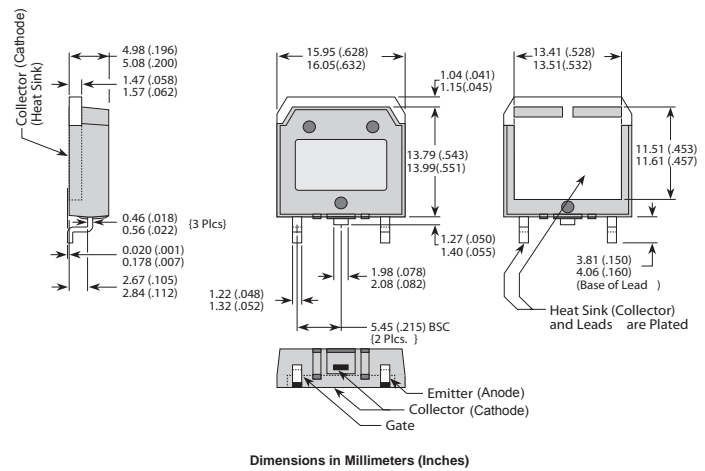

FIGURE 23. Junction Capacitance vs. Reverse Voltage

TO-247 Package Outline



D³PAK Package Outline



Disclaimer:

The information contained in the document (unless it is publicly available on the Web without access restrictions) is PROPRIETARY AND CONFIDENTIAL information of Microsemi and cannot be copied, published, uploaded, posted, transmitted, distributed or disclosed or used without the express duly signed written consent of Microsemi. If the recipient of this document has entered into a disclosure agreement with Microsemi, then the terms of such Agreement will also apply. This document and the information contained herein may not be modified, by any person other than authorized personnel of Microsemi. No license under any patent, copyright, trade secret or other intellectual property right is granted to or conferred upon you by disclosure or delivery of the information, either expressly, by implication, inducement, estoppels or otherwise. Any license under such intellectual property rights must be approved by Microsemi in writing signed by an officer of Microsemi.

Microsemi reserves the right to change the configuration, functionality and performance of its products at anytime without any notice. This product has been subject to limited testing and should not be used in conjunction with life-support or other mission-critical equipment or applications. Microsemi assumes no liability whatsoever, and Microsemi disclaims any express or implied warranty, relating to sale and/or use of Microsemi products including liability or warranties relating to fitness for a particular purpose, merchantability, or infringement of any patent, copyright or other intellectual property right. Any performance specifications believed to be reliable but are not verified and customer or user must conduct and complete all performance and other testing of this product as well as any user or customer's final application. User or customer shall not rely on any data and performance specifications or parameters provided by Microsemi. It is the customer's and user's responsibility to independently determine suitability of any Microsemi product and to test and verify the same. The information contained herein is provided "AS IS, WHERE IS" and with all faults, and the entire risk associated with such information is entirely with the User. Microsemi specifically disclaims any liability of any kind including for consequential, incidental and punitive damages as well as lost profit. The product is subject to other terms and conditions which can be located on the web at <http://www.microsemi.com/terms-a-conditions>.