

14118 Stowe Drive, Suite B
 Poway, CA 92064
 TEL: (858) 621-2700 | FAX: (858) 486-1927
 URL: www.zcomm.com
 EMAIL: applications@zcomm.com

Voltage-Controlled Oscillator Surface Mount Module

Applications

- Digital Radio Equipment
- Fixed Wireless Access
- Satellite Communication Systems

Application Notes

- AN-101: Mounting and Grounding
- AN-102: Output Loading
- AN-107: Manual Soldering

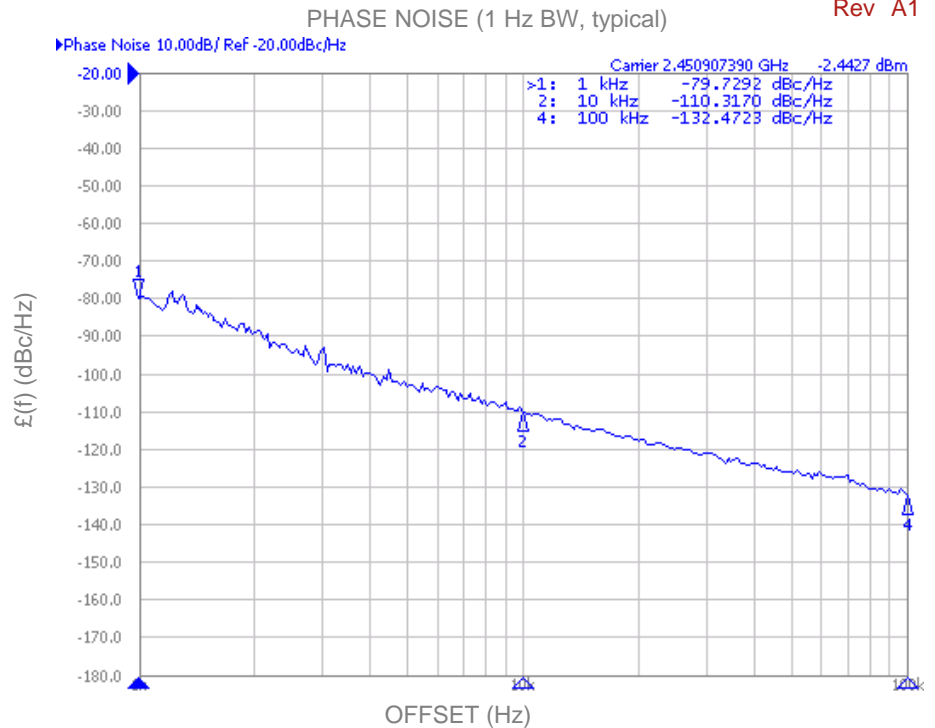

Performance Specifications	Min	Typ	Max	Units
Oscillation Frequency Range	2410		2492	MHz
Phase Noise @ 10 kHz offset (1 Hz BW)		-108		dBc/Hz
Harmonic Suppression (2nd)		-20	-15	dBc
Tuning Voltage	0.4		5.4	Vdc
Tuning Sensitivity (avg.)		20		MHz/V
Power Output	0	2.5	5	dBm
Load Impedance		50		Ω
Input Capacitance			50	pF
Pushing			1	MHz/V
Pulling (12 dB Return Loss, Any Phase)			1	MHz
Operating Temperature Range	-40		85	$^{\circ}\text{C}$
Package Style	MINI-16-SM			

Power Supply Requirements	Min	Typ	Max	Units
Supply Voltage (Vcc, nom.)		5		Vdc
Supply Current (Icc)		25	30	mA

Additional Notes

Tuning Curve, typ.

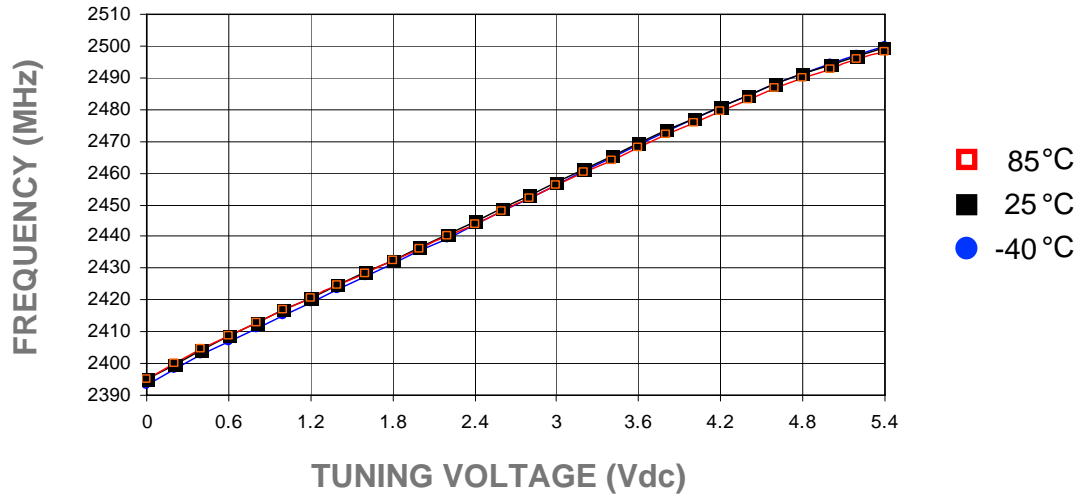

Power Curve, typ.

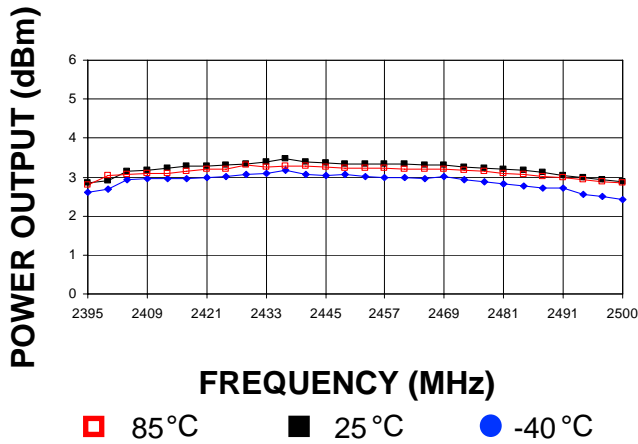

Footprint

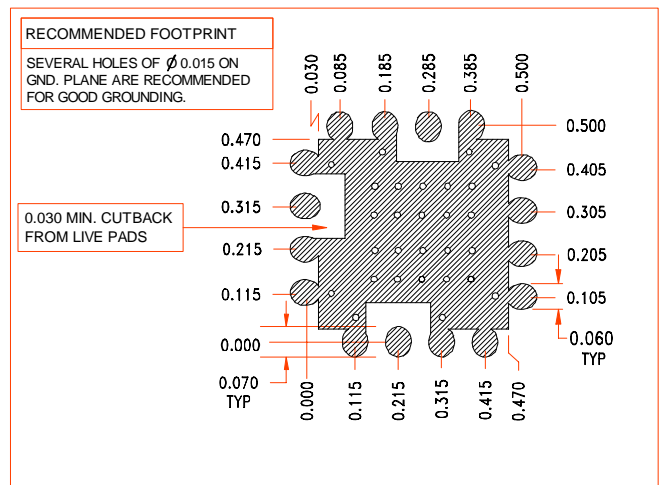

Physical Dimensions

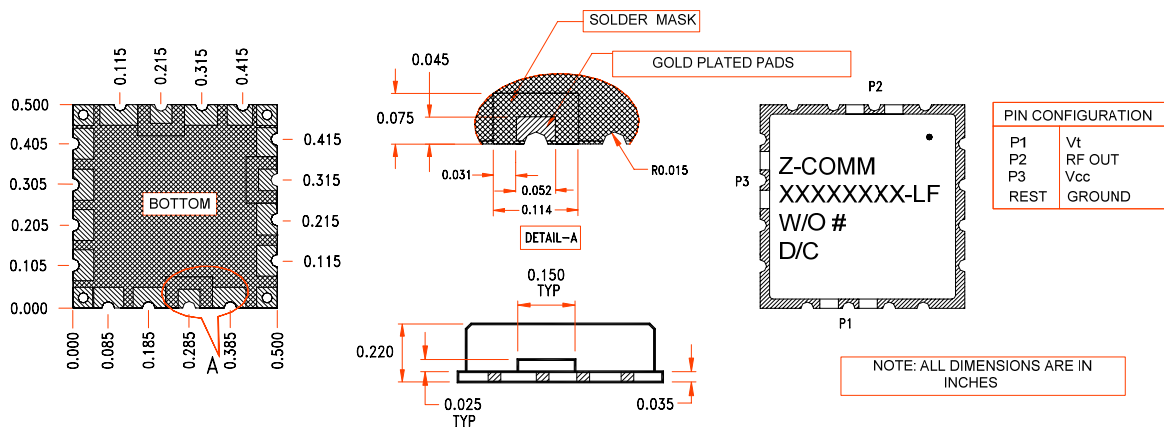

LFSuffix = RoHS Compliant. All specifications are subject to change without notice.