

GT32 Series

— Shielded connector for high speed transmission / USB3.0, HDMI1.4 —

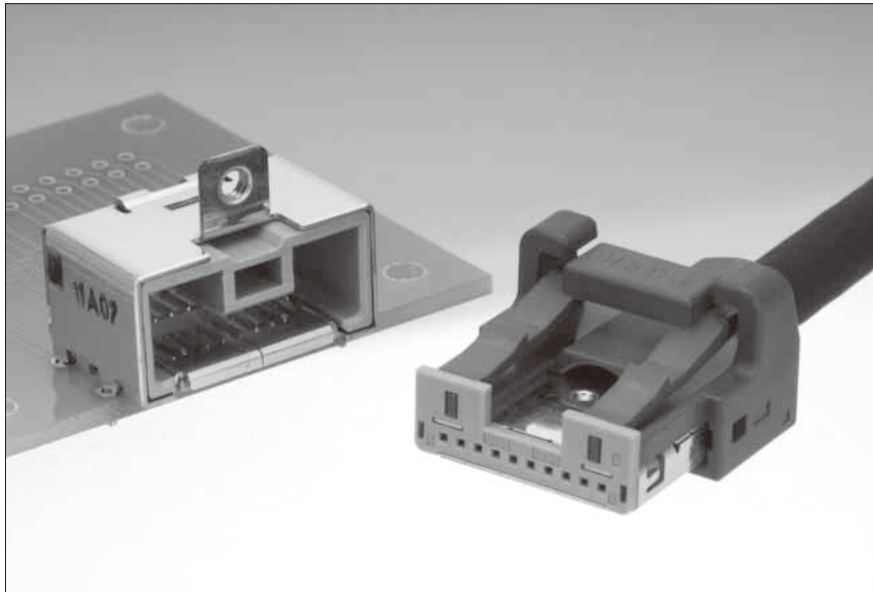

■ Features

- Full shielded structure
- Suitable for in-vehicle shielded connectors

■ Applications

In-vehicle data communication, etc.
(10-pos : USB3.0 support)
(19-pos : HDMI1.4 equivalent signal support)

F connector

Center terminal

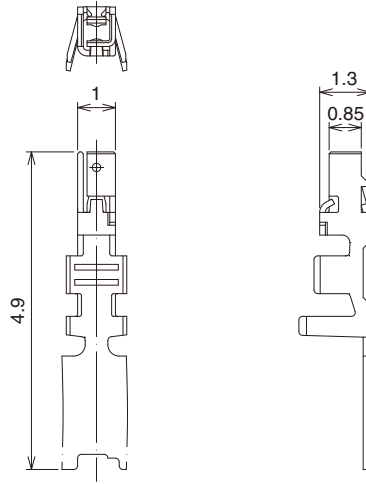
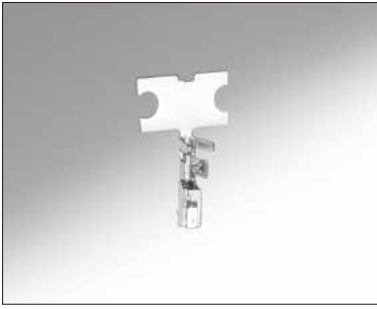

| Part No. | HRS No. | Material | Plating | Conductor Size (AWG) | Outer Diameter | Packaging | RoHS |
|--------------|------------|--------------|-------------|----------------------|----------------|-----------------|------|
| GT32-2428SCF | 782-0007-8 | Copper alloy | Tin plating | 24 to 28 AWG | φ 0.8 to 1.0 | 10,000 pcs/reel | YES |

10-pos straight plug connector

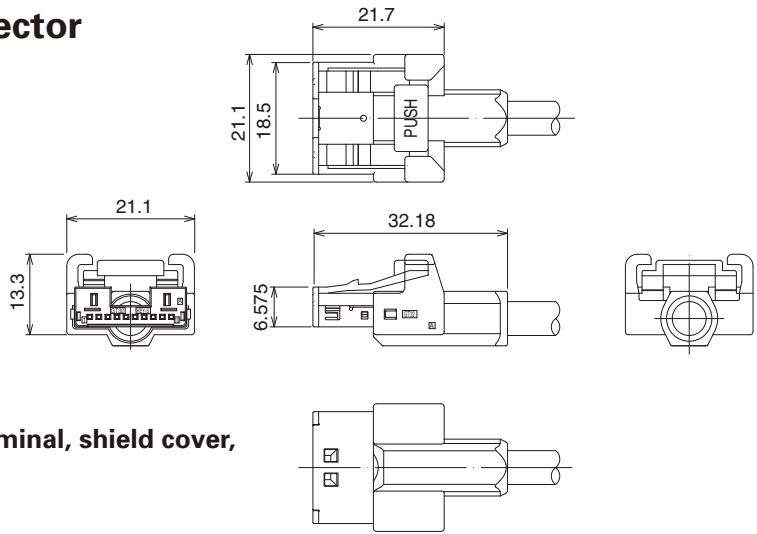
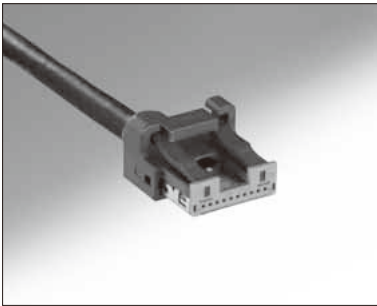

◆ This product consists of six parts.
(Housing, S insulation case, outer terminal, shield cover, shield plate, center terminal)

Housing

| Part No. | HRS No. | Material | Color | Packaging | RoHS |
|-------------|------------|----------|-----------|-----------|------|
| GT32-10S-HU | 782-0003-7 | PBT | Dark Gray | 1 | YES |

S insulation case

| Part No. | HRS No. | Material | Color | Packaging | RoHS |
|---------------|------------|----------|------------|-----------|------|
| GT32-10S-1.5C | 782-0002-4 | PBT | Light Gray | 1 | YES |

Outer terminal

| Part No. | HRS No. | Material | Plating | Outer Diameter | Packaging | RoHS |
|--------------|------------|--------------|-------------|----------------|-----------|------|
| GT32-10S-6CF | 782-0004-0 | Copper alloy | Tin plating | φ 5.4 to 5.8 | 1 | YES |

Shield cover

| Part No. | HRS No. | Material | Plating | Packaging | RoHS |
|-------------|------------|----------|-------------|-----------|------|
| GT32-10S-SC | 782-0005-2 | Brass | Tin plating | 1 | YES |

Shield plate

| Part No. | HRS No. | Material | Plating | Packaging | RoHS |
|-------------|------------|----------|-------------|-----------|------|
| GT32-10S-SP | 782-0006-5 | Brass | Tin plating | 1 | YES |

Center terminal

| Part No. | HRS No. | Material | Plating | Conductor Size (AWG) | Outer Diameter | Packaging | RoHS |
|--------------|------------|--------------|-------------|----------------------|----------------|-----------------|------|
| GT32-2428SCF | 782-0007-8 | Copper alloy | Tin plating | 24 to 28 AWG | φ 0.8 to 1.0 | 10,000 pcs/reel | YES |

Mating table

| Color | Cable connector | Board connector |
|------------|-----------------|-----------------------------------|
| Light Gray | GT32-10S-ASSY | Right-angle type GT32-10P-1.5H |

■ 10-pos board connector (right-angle SMT type)

● M2.5 screw flange type

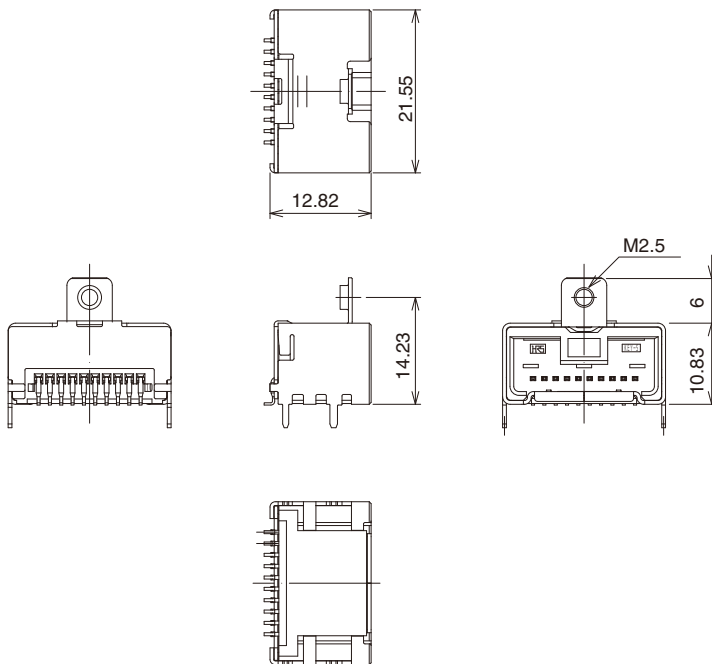
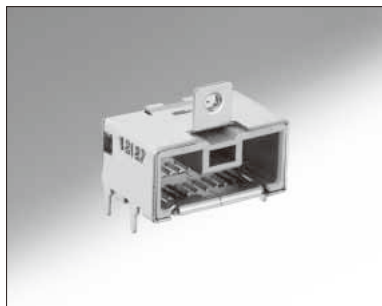

| Part No. | HRS No. | Color | Material/Plating | Packaging | RoHS |
|---------------|------------|------------|---|-----------|------|
| GT32-10P-1.5H | 782-0001-1 | Light Gray | Housing : PPS Center terminal : Brass/Tin plating Outer terminal : Copper alloy/Tin plating | 1 | YES |

■ 19-pos straight connector

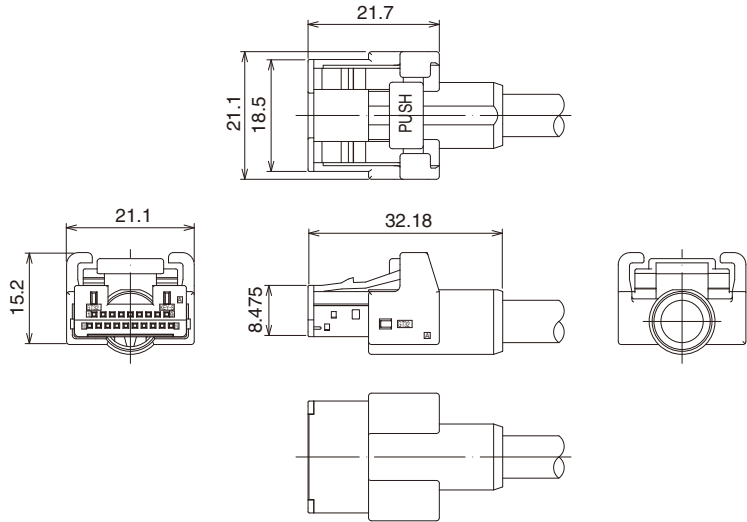
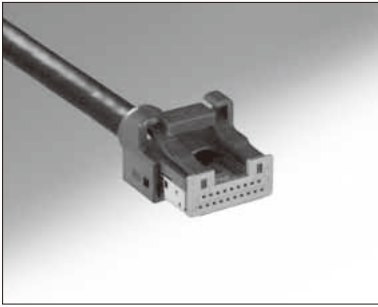

◆ This product consists of six parts.
 (Housing, S insulation case A, S insulation case B,
 outer terminal, shield cover, center terminal)

● Housing

| Part No. | HRS No. | Material | Color | Packaging | RoHS |
|--------------|------------|----------|-----------|-----------|------|
| GT32-19DS-HU | 782-0013-0 | PBT | Dark Gray | 1 | YES |

● S insulation case A

| Part No. | HRS No. | Material | Color | Packaging | RoHS |
|------------------|------------|----------|------------|-----------|------|
| GT32-19DS-0.75CA | 782-0010-2 | PBT | Light Gray | 1 | YES |

● S insulation case B

| Part No. | HRS No. | Material | Color | Packaging | RoHS |
|------------------|------------|----------|------------|-----------|------|
| GT32-19DS-0.75CB | 782-0014-3 | PBT | Light Gray | 1 | YES |

● Outer terminal

| Part No. | HRS No. | Material | Plating | Outer Diameter | Packaging | RoHS |
|---------------|------------|--------------|-------------|----------------|-----------|------|
| GT32-19DS-7CF | 782-0011-5 | Copper alloy | Tin plating | φ 6.8 to 7.2 | 1 | YES |

● Shield cover

| Part No. | HRS No. | Material | Plating | Packaging | RoHS |
|--------------|------------|----------|-------------|-----------|------|
| GT32-19DS-SC | 782-0012-8 | Brass | Tin plating | 1 | YES |

● Center terminal

| Part No. | HRS No. | Material | Plating | Conductor Size (AWG) | Outer Diameter | Packaging | RoHS |
|--------------|------------|--------------|-------------|----------------------|----------------|-----------------|------|
| GT32-2428SCF | 782-0007-8 | Copper alloy | Tin plating | 24 to 28 AWG | φ 0.8 to 1.0 | 10,000 pcs/reel | YES |

◆ Mating table

| Color | Cable connector | Board connector | |
|------------|-----------------|------------------|-------------------|
| | | Right-angle type | DIP type |
| Light Gray | GT32-19DS-ASSY | GT32-19DP-0.75H | GT32-19DP-0.75DSA |

Sep.1.2018 Copyright © 2018 HIROSE ELECTRIC CO., LTD. All Rights Reserved.

GT5
GT13
GT16
PO5G
GT19
GT21
GT26
GT36
GT11
GT17
GT32
GT3
GT7
GT10
GT18W
GT25
GT8E
GT9
GT15

■ 19-pos board connector (right-angle SMT type)

● M2.5 screw flange type

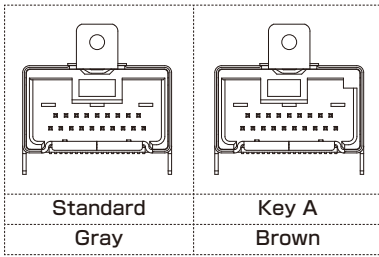
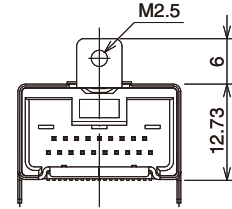
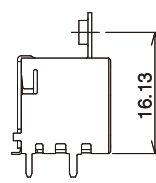
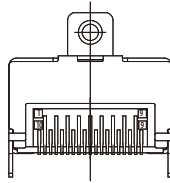
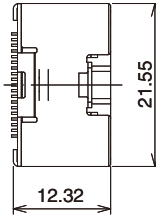
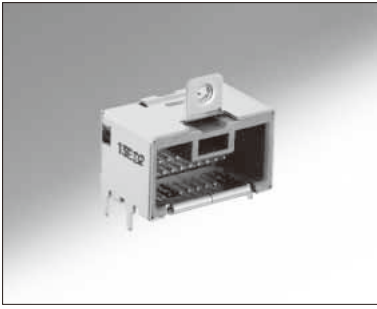

Standard
Gray

Key A
Brown

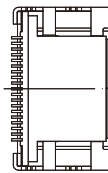

| Part No. | HRS No. | Color | Material/Plating | Packaging | RoHS |
|--------------------|------------|-------|--|-----------|------|
| GT32-19DP-0.75H | 782-0009-3 | Gray | Housing : PA Center terminal : Brass/Tin plating Outer terminal : Copper alloy/Tin plating | 1 | YES |
| GT32-19DP-0.75H(A) | 782-0015-6 | Brown | | | |

■ 19-pos board connector (straight DIP type)

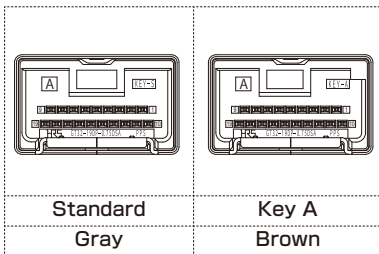
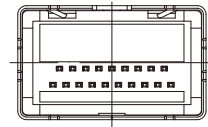
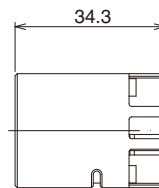
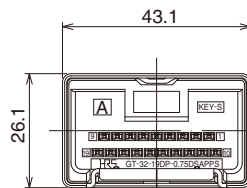
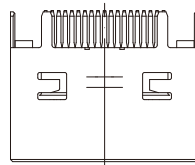

Standard
Gray

Key A
Brown

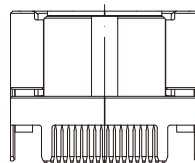

| Part No. | HRS No. | Color | Material/Plating | Packaging | RoHS |
|-----------------------|------------|-------|---|-----------|------|
| GT32-19DP-0.75DSA | 782-0037-9 | Gray | Housing : PPS Center terminal : Brass/Tin plating Outer terminal : Copper alloy/Tin plating | 1 | YES |
| GT32-19DP-0.75DSA (A) | 782-0045-7 | Brown | | | |

◆ Crimping tools

Operation manuals are available for each crimp tool. Please contact sales personnel.

● Automatic Crimping Machine

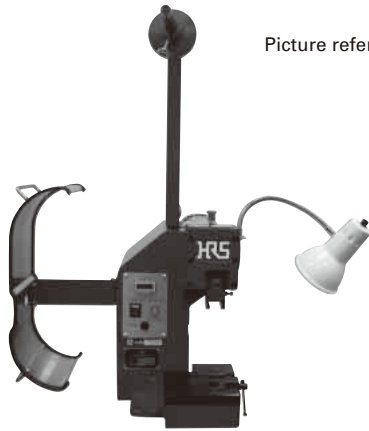

Picture reference only

Specifications

| Item | Specification | Remarks |
|-------------------|-----------------------|---------------|
| Press capacity | 1.5Ton | |
| Stroke length | 30mm | |
| Number of strokes | 200spm (50Hz) | 240spm (60Hz) |
| Weight | 75kg | |
| Motor | 0.2kW | AC100V |
| Crimping speed | 2000 to 4000 pcs/hour | |

Part No. CM-105C

Note : Please refer to the table below for applicator product numbers.

Applicator (for use with the automatic crimping machine)

| Terminal Product No. | Terminal HRS No. | Tool Product No. | Tool HRS No. |
|----------------------|------------------|------------------|---------------|
| GT32-2428SCF | 782-0007-8 | AP105-GT32-2428S | 901-5223-2 00 |

Note 1 : The crimp height is to be set for each cable type. Please request your contact person for details.

Note 2 : The P/N for applicator/tool may differ from the above P/N depending on the cable specification.

Special terminal insertion tool for GT32-10S-1.5C

| Terminal Product No. | Terminal HRS No. | Tool No. | Tool HRS No. |
|----------------------|------------------|----------------|--------------|
| GT32-2428SCF | 782-0007-8 | GT32-CON/PR-MD | 902-5125-0 |

* This product is used only to insert GT32-2428SCF terminal into S insulation case GT32-10S-1.5C.

Please note that this product cannot be used for other terminals and insulation cases.

● Hand press

Hand press

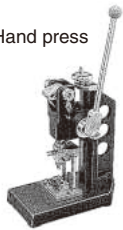

Product No. HOS-7

Outer terminal applicator (for hand press mounting)

| Product Part No. | Product HRS No. | Tool Part No. | Tool HRS No. |
|------------------|-----------------|-----------------------|---------------|
| GT32-10S-6CF | 782-0004-0 | GT32-10S-6/CR-MP | 902-5118-4 00 |
| | | GT32-10S-6/CR-MP(01) | 902-5118-4 01 |
| GT32-19DS-7CF | 782-0011-5 | GT32-19DS-7/CR-MP | 902-5124-7 00 |
| | | GT32-19DS-7/CR-MP(01) | 902-5124-7 01 |

Note 1 : (01) version is to be supplied with the hand press "HOS-7".

Note 2 : The crimp height is to be set for each cable type. Please request your contact person for details.

Note 3 : The P/N for applicator/tool may differ from the above P/N depending on the cable specification.